



## TECHNOLOGY DATA SHEET & SPECIFICATIONS

MODEL: 5050SUBC

### Features

- InGaN Green\*3 Dice LED
- Size : 5.0mm×5.0mm×1.5mm
- High luminous intensity, high reliability and long life
- With ROHS Compliant



### Descriptions

- The 5050 SMD LED is much smaller than lead frame type components thus enable smaller board size, higher packing density, reduced storage space and finally smaller equipment to be obtained
- Besides, lightweight makes them ideal for miniature applications.etc

### Usage Notes:

- Surge will damage the LED
- When using LED, it must use a protective resistor in series with DC current about 20mA

### Applications

- Amusement equipment ·
- Information boards ·
- Flashlight for digital camera of cellular phone ·
- Lighting for small size device.

### Device Selection Guide

LED Part No.	Chip		Lens Color
	Material	Emitted Color	
5050SUBC	InGaN	BLUE	Water clear

## TECHNOLOGY DATA SHEET & SPECIFICATIONS

MODEL: 5050SUBC

### Package Dimensions

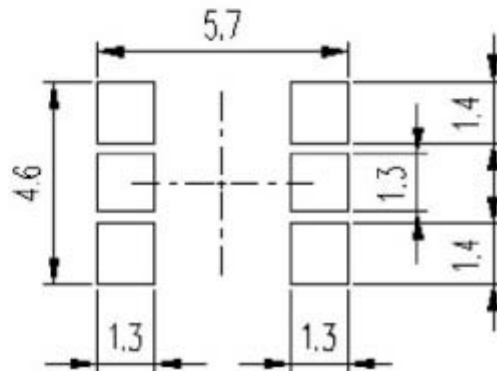
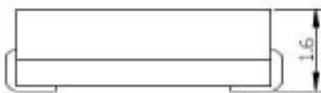
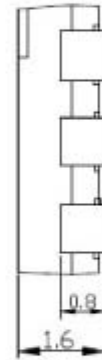
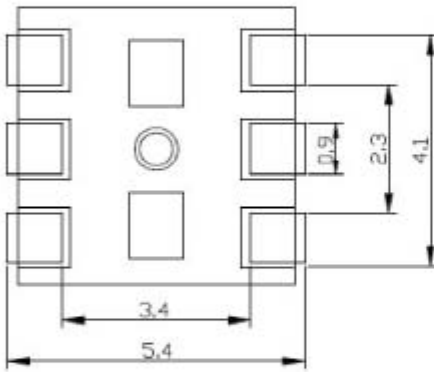
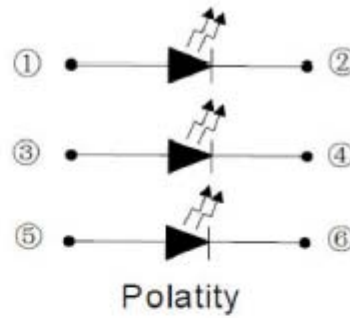
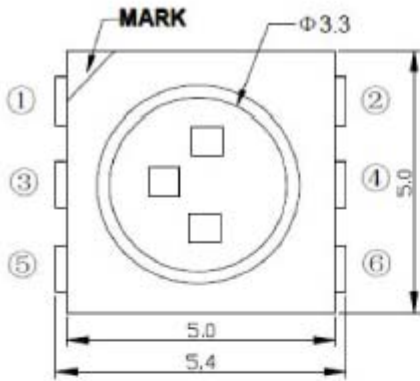

### Notes:

- Other dimensions are in millimeters, tolerance is 0.25mm except being specified.
- Protruded resin under flange is 1.5mm Max LED.
- Bare copper alloy is exposed at tie-bar portion after cutting.



## TECHNOLOGY DATA SHEET & SPECIFICATIONS

MODEL: 5050SUBC

Electro-Optical Characteristics (Ta=25□)

Parameter	Symbol	Min.	Typ.	Max.	Unit	Test Condition
Luminous Intensity	Iv	2500	---	3500	mcd	IF=20mA(Note1)
Viewing Angle	2θ <sub>1/2</sub>	---	120	---	Deg	(Note 2)
Peak Emission Wavelength	λp	460	---	470	nm	IF=20mA
Spectral Line Half-Width	Δλ	---	30	25	nm	IF=20mA
Forward Voltage	V <sub>F</sub>	3.0	---	3.4	V	IF=20mA
Reverse Current	I <sub>R</sub>	---	---	50	μA	VR=5V

### Note:

1. Luminous intensity is measured with a light sensor and filter combination that approximates the CIE eye-response curve.
2. θ<sub>1/2</sub> is the off-axis angle at which the luminous intensity is half the axial luminous intensity.



## TECHNOLOGY DATA SHEET & SPECIFICATIONS

MODEL: 5050SUBC

### APPLICATION NOTES:

#### 1)Soldering:

##### ① Manual soldering by soldering iron:

The use of a soldering iron of less than 25W is recommended and the temperature of the iron must be kept at no higher than 300□.

##### ② Reflow soldering:

a. The temperature profile as shown in Fig.3 is recommended for soldering SMD LED by the reflow furnace.

b. Care must be taken that the products be handled after their temperature has dropped down to the normal room temperature after soldering.

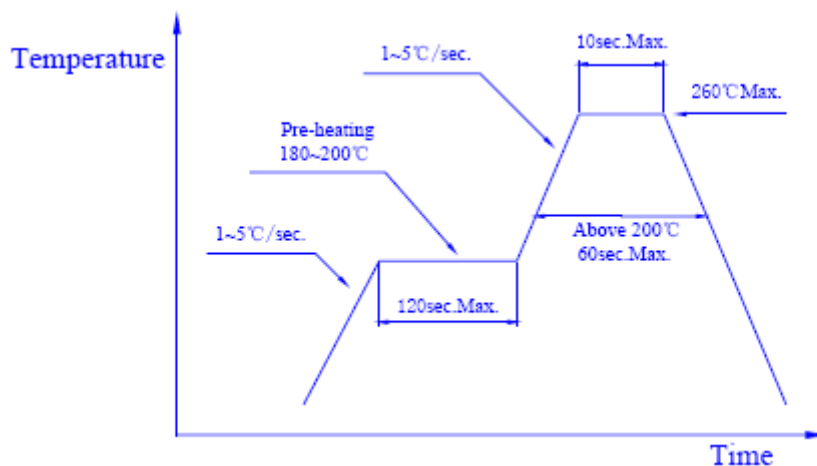

Fig.3

#### 2)Post solder cleaning:

When cleaning after soldering is needed, the following conditions must be adhered to.

##### ① Cleaning solvents: Freon TF or equivalent or alcohol.

##### ② Temperature: 50□ Max.for 30 seconds or 30□Max.for 3 minutes



## TECHNOLOGY DATA SHEET & SPECIFICATIONS

MODEL: 5050SUBC

③ Ultrasonic: 300W Max.

### 3) OTHERS:

- a. Care must be taken not to cause stress to the epoxy resin portion of SMD LED while it is exposed to the high temperature.
- b. Care must be taken not to the rub the epoxy resin portion of SMD LED with a hard or sharp edged article such as the sand blast and the metal hook as the epoxy resin is rather soft and liable to be damaged.