

High Directivity

Monolithic Amplifier

VNA-28B+

50Ω 0.5 to 2.5 GHz

The Big Deal

- 2.8 & 5V operation
- High directivity, 16-23 dB
- Footprint compatible with VNA-28 & VNA-28A+

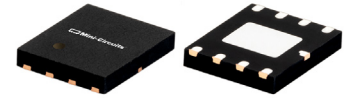

CASE STYLE: DL1020

Product Overview

VNA-28B+ is a wideband amplifier providing high directivity. It has built-in DC blocks at input and output and a separate lead for DC. It is fabricated using PHEMT technology and enclosed in a 5x6 mm MCLP plastic package.

Key Features

Feature	Advantages
Footprint compatible with VNA-28 & VNA-28A+	Can be used as a replacement for obsolete parts VNA-28+ and VNA-28A+ without PCB design change. Refer to AN-60-089
High directivity, 16-23 dB	Acts as a low cost isolator, minimizing the interaction of pre and post circuits.
Built-in DC blocks	Eliminates need for external DC blocks, lowering PCB size & cost.
Separate terminal for DC	Eliminates need for output bias-tee, further reducing external component count, cost & PCB size.
DC voltage, 2.8 to +5V	No voltage dropping resistor required, allowing low voltage operation.
5 x 6mm 8-lead MCLP package	Provides low inductance, repeatable transitions, and excellent thermal contact to PCB.



High Directivity

Monolithic Amplifier

0.5-2.5 GHz

Product Features

- 2.8V & 5V operation
- no external biasing circuit required
- internal DC blocking at RF input and output
- high directivity, 16-23 dB typ.
- wide bandwidth, 0.5 to 2.5 GHz
- low noise figure, 3.0 dB typ.
- output power, up to +11.4 dBm typ. at 1.5 GHz
- potential replacement for VNA-28A+ see (AN-60-089)
- low cost

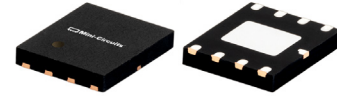

Generic photo used for illustration purposes only

CASE STYLE: DL1020

VNA-28B+

+RoHS Compliant

The +Suffix Identifies RoHS Compliance. See our web site for RoHS Compliance methodologies and qualifications

Typical Applications

- buffer amplifier
- cellular
- PCN

General Description

VNA-28B+ is a wideband amplifier offering high dynamic range. It is enclosed in an 8-lead 5X6 mm MCLP package, footprint compatible with SOIC-8 lead package. VNA-28B+ is fabricated using PHEMT technology. It has built-in DC blocks at RF-IN and RF-OUT ports and separate pad for DC eliminating the need for bias tee.

simplified schematic and pad description

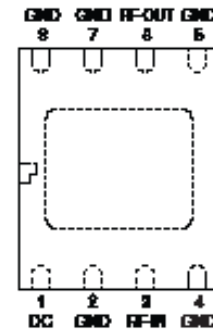
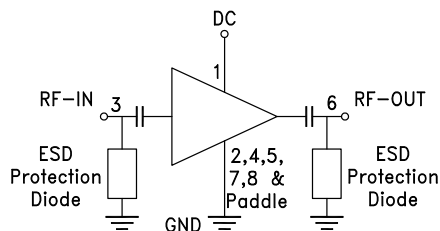

Pad description

Function	Pad Number	Description
RF-IN	3	RF input pin.
RF-OUT	6	RF output pin.
DC	1	Bias pin
GND	2,4,5,7,8 and paddle	Connections to ground. Use via holes as shown in "Suggested Layout for PCB Design" to reduce ground path inductance for best performance.

Electrical Specifications¹ at 25°C, 50Ω unless noted

Parameter	Condition (GHz)	Vs=5V			Vd=2.8V	Units
		Min.	Typ.	Max.	Typ.	
Frequency range		0.5		2.5	0.5-2.5	GHz
Gain	0.5		21.2		20.2	dB
	0.75		23.2		21.9	
	1.0		23.5		22.0	
	1.5		23.0		21.1	
	2.0	19.5	21.7	24.0	19.7	
	2.5		19.9		17.9	
Input return loss	0.5		5.0		5.2	dB
	0.75		10.0		10.7	
	1.0		14.9		16.1	
	1.5		17.3		19.4	
	2.0		16.1		17.0	
	2.5		13.9		14.0	
Output return loss	0.5		12.0		12.5	dB
	0.75		13.9		21.0	
	1.0		11.7		17.9	
	1.5		10.6		16.3	
	2.0		11.2		17.3	
	2.5		13.3		20.8	
Output power @ 1dB compression	0.5		13.3		11.4	dBm
	0.75		12.9		11.4	
	1.0		11.9		10.8	
	1.5		11.4		10.2	
	2.0		10.9		9.7	
	2.5		10.5		9.1	
Output IP3	0.5		24.3		22.2	dBm
	0.75		24.6		22.3	
	1.0		23.4		21.5	
	1.5		22.7		20.8	
	2.0		21.8		20.1	
	2.5		21.2		19.3	
Noise figure	0.5		3.2		3.3	dB
	0.75		3.0		3.1	
	1.0		3.0		3.0	
	1.5		2.9		3.1	
	2.0		3.0		3.1	
	2.5		3.1		3.3	
Directivity (Isolation-Gain)	0.5		17.1		19.5	dB
	0.75		20.0		23.0	
	1.0		23.3		22.9	
	1.5		20.7		18.9	
	2.0		18.7		17.4	
	2.5		17.5		16.5	
DC Current			34	45	32	mA
Device current variation vs temperature ²			16		7	μA/°C
Device current variation vs voltage			0.0004 ³		0.0013 ⁴	mA/mV
Thermal resistance at 85°C			64		64	°C/W

1. Measured on Mini-Circuits Characterization test board TB-01-28B+. See Characterization Test Circuit (Fig. 1)

2. Current at 85°C - Current at -45°C/130

3. Current at 5.25V - Current at 3.29V/1.35

4. Current at 3.9V - Current at 2.66V/1.24

Absolute Maximum Ratings⁵

Parameter	Ratings
Operating Temperature	-40°C to 85°C
Storage Temperature	-55°C to 100°C
DC Voltage	+7V at pad 1 1V at pads 3 & 6; 10V at pads 3,6
Power Dissipation	700 mW
Input Power	+5 dBm (continuous operation) +28 dBm (5 minutes max.)

5. Permanent damage may occur if any of these limits are exceeded.

These ratings are not intended for continuous normal operation.



Characterization Test Circuit

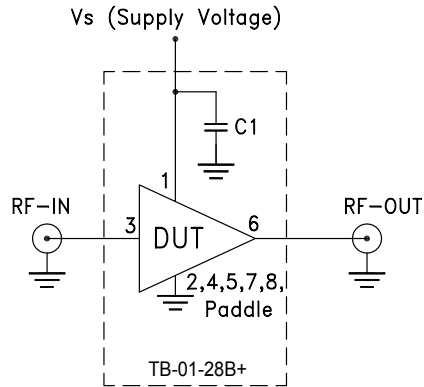

Fig 1. Block Diagram of Test Circuit used for characterization. (DUT soldered on Mini-Circuits Characterization test board TB-01-28B+) Gain, Return loss, Output power at 1dB compression (P1 dB), output IP3 (OIP3) and noise figure measured using Agilent’s N5242A PNA-X microwave network analyzer.

Conditions:

1. Gain: Pin= -25dBm
2. Output IP3 (OIP3): Two tones, spaced 1 MHz apart, -5 dBm/tone at input.

Recommended Application Circuit

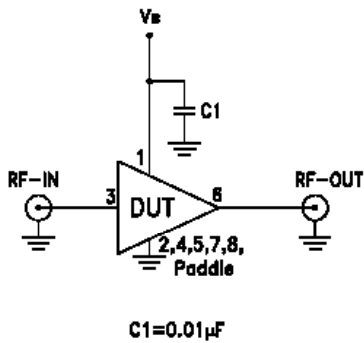

Fig 2. Recommended Application Circuit

Product Marking



Additional Detailed Technical Information	
<i>additional information is available on our dash board. To access this information click here</i>	
Performance Data	Data Table
	Swept Graphs
	S-Parameter (S2P Files) Data Set (.zip file)
Case Style	DL1020 <i>Plastic model, 8 lead, 5x6 mm MCLP, tin-silver over nickel</i>
Tape & Reel Standard quantities available on reel	F68 <i>7" reels with 20, 50, 100, 200, 500 or 1K devices 13" reels with 2K, 3K, 4K devices</i>
Suggested Layout for PCB Design	PL-077
Evaluation Board	TB-01-28B+
Environmental Ratings	ENV08T1

ESD Rating

Human Body Model (HBM): Class 1A (250V to <500V) in accordance with ANSI/ESD STM 5.1 - 2001

Machine Model (MM): Class M1 (Pass 25V) in accordance with ANSI/ESD STM5.2-1999

MSL Rating

Moisture Sensitivity: MSL1 in accordance with IPC/JEDEC J-STD-020D

MSL Test Flow Chart

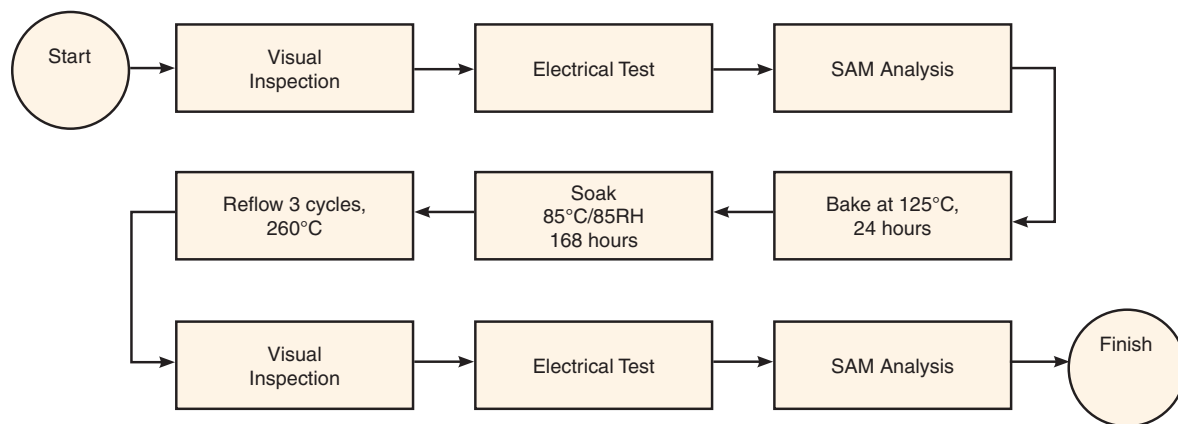

Additional Notes

- A. Performance and quality attributes and conditions not expressly stated in this specification document are intended to be excluded and do not form a part of this specification document.
- B. Electrical specifications and performance data contained in this specification document are based on Mini-Circuits' applicable established test performance criteria and measurement instructions.
- C. The parts covered by this specification document are subject to Mini-Circuits standard limited warranty and terms and conditions (collectively, "Standard Terms"); Purchasers of this part are entitled to the rights and benefits contained therein. For a full statement of the Standard Terms and the exclusive rights and remedies thereunder, please visit Mini-Circuits' website at www.minicircuits.com/MCLStore/terms.jsp

Typical Performance Data

NOTE: Use PDF Bookmarks to view DATA at required conditions

Definitions:

Input Return Loss = -S11 (dB)

Gain(Power Gain) = S21 (dB)

Reverse Isolation = -S12 (dB)

Output Return Loss = -S22 (dB)

TEST CONDITIONS: Vd = 5.00V, Id = 34.14mA @ Temperature = +25°C

FREQ	Gain	Isolation	Input Return Loss	Output Return Loss	Stability		IP-3 Output	1dB Comp. Output	Noise Figure
					K	Measure			
(MHz)	(dB)	(dB)	(dB)	(dB)	K	Measure	(dBm)	(dBm)	(dB)
200	4.65	38.50	2.19	2.59	3.90	0.74	13.30	2.48	6.31
300	13.99	36.71	2.59	5.36	1.83	1.15	20.74	8.94	3.84
400	18.84	37.05	3.46	8.34	1.76	1.28	23.79	12.21	3.20
500	21.39	38.48	4.96	11.88	2.22	1.25	24.77	13.55	3.01
600	22.66	40.48	6.88	14.53	2.96	1.17	25.49	13.45	3.17
700	23.28	42.67	8.97	14.65	3.93	1.09	25.38	13.32	2.90
800	23.57	44.75	11.09	13.59	5.06	1.03	24.90	12.97	2.87
900	23.69	46.40	13.09	12.59	6.17	0.99	24.97	12.98	2.83
1000	23.72	47.24	14.88	11.87	6.83	0.96	23.89	12.21	2.83
1100	23.67	47.23	16.34	11.37	6.88	0.94	24.07	12.37	2.89
1200	23.60	46.58	17.25	11.05	6.45	0.93	23.68	12.05	2.88
1300	23.48	45.71	17.70	10.85	5.91	0.92	23.56	11.95	2.89
1400	23.33	44.85	17.80	10.73	5.44	0.92	23.46	11.92	2.85
1500	23.16	43.97	17.60	10.68	5.02	0.92	22.91	11.54	2.87
1600	22.96	43.23	17.40	10.71	4.71	0.92	22.94	11.58	2.88
1700	22.73	42.48	17.09	10.80	4.45	0.92	22.54	11.28	2.89
1800	22.48	41.86	16.85	10.95	4.28	0.92	22.78	11.44	2.88
1900	22.19	41.19	16.45	11.12	4.11	0.92	22.43	11.32	2.91
2000	21.89	40.67	16.09	11.36	4.02	0.93	22.03	11.02	2.92
2200	21.21	39.43	15.37	11.93	3.80	0.94	21.55	10.77	2.94
2400	20.44	38.00	14.46	12.87	3.56	0.95	21.92	10.97	3.04
2600	19.49	36.21	13.61	15.10	3.29	0.98	21.79	10.81	3.07
2800	18.34	34.96	12.12	19.11	3.24	1.02	21.41	10.42	3.12
3000	17.50	35.79	9.92	18.54	3.71	1.07	20.80	9.98	3.19
3200	16.67	36.59	8.37	18.74	4.22	1.12	20.35	9.55	3.38
3400	15.79	37.06	7.21	19.67	4.67	1.17	19.98	9.23	3.57
3600	14.92	37.20	6.30	21.58	4.96	1.22	19.51	8.84	3.75
3800	14.00	37.39	5.52	24.43	5.30	1.27	19.12	8.42	3.93
4000	13.07	37.16	4.90	28.08	5.41	1.32	18.64	7.96	4.20
4200	12.20	37.23	4.39	26.74	5.67	1.36	18.29	7.59	4.38
4400	11.36	37.44	3.96	23.09	6.02	1.39	17.88	7.19	4.67
4600	10.48	37.02	3.60	19.49	5.96	1.42	17.45	6.82	4.99
4800	9.62	37.16	3.31	16.99	6.29	1.43	17.04	6.37	5.23
5000	8.78	36.99	3.06	15.10	6.41	1.44	16.48	6.05	5.51
5100	8.34	37.10	2.97	14.26	6.65	1.44	16.35	5.73	5.67
5200	7.90	36.67	2.83	13.60	6.43	1.44	15.99	5.45	5.83
5300	7.41	36.65	2.76	12.88	6.62	1.44	15.80	5.16	6.01
5400	6.88	36.50	2.65	12.27	6.69	1.44	15.51	4.75	6.29
5500	6.33	37.27	2.63	11.40	7.63	1.42	14.94	4.47	6.52

Typical Performance Data

Definitions:

Input Return Loss = -S11 (dB)

Gain(Power Gain) = S21 (dB)

Reverse Isolation = -S12 (dB)

Output Return Loss = -S22 (dB)

TEST CONDITIONS: Vd = 3.90V, Id = 33.78mA @ Temperature = +25°C

FREQ	Gain	Isolation	Input Return Loss	Output Return Loss	Stability		IP-3 Output	1dB Comp. Output	Noise Figure
					K	Measure			
(MHz)	(dB)	(dB)	(dB)	(dB)	K	Measure	(dBm)	(dBm)	(dB)
200	4.56	38.59	2.19	2.62	4.03	0.75	13.03	2.32	6.28
300	13.82	36.97	2.57	5.34	1.93	1.15	20.24	8.63	3.84
400	18.61	37.48	3.48	8.34	1.93	1.27	23.27	11.82	3.24
500	21.09	39.09	5.04	12.14	2.51	1.25	24.14	13.10	3.03
600	22.30	41.27	7.02	15.77	3.45	1.17	24.73	13.05	3.20
700	22.87	43.56	9.14	16.92	4.66	1.10	24.57	12.92	2.92
800	23.12	45.50	11.29	15.98	5.95	1.04	24.19	12.61	2.86
900	23.22	46.61	13.32	14.84	6.86	1.01	24.24	12.60	2.87
1000	23.21	46.65	15.14	13.99	6.97	0.98	23.34	11.92	2.81
1100	23.14	46.00	16.67	13.40	6.55	0.97	23.42	12.05	2.89
1200	23.03	45.02	17.64	13.03	5.94	0.96	23.13	11.75	2.89
1300	22.89	44.02	18.13	12.80	5.39	0.95	23.02	11.64	2.93
1400	22.72	43.12	18.25	12.67	4.95	0.95	22.81	11.61	2.90
1500	22.52	42.25	18.02	12.62	4.59	0.94	22.38	11.24	2.87
1600	22.30	41.54	17.76	12.66	4.34	0.94	22.40	11.28	2.93
1700	22.05	40.82	17.35	12.75	4.12	0.95	22.02	11.00	2.91
1800	21.79	40.23	17.00	12.93	3.97	0.95	22.20	11.11	2.91
1900	21.49	39.57	16.52	13.12	3.82	0.95	21.97	10.99	2.97
2000	21.18	39.07	16.07	13.41	3.74	0.95	21.53	10.69	2.95
2200	20.50	37.89	15.22	14.07	3.55	0.96	21.09	10.44	2.94
2400	19.74	36.57	14.28	15.21	3.35	0.98	21.34	10.59	3.06
2600	18.79	35.00	13.40	18.12	3.14	1.00	21.20	10.37	3.10
2800	17.68	34.14	11.83	24.43	3.18	1.04	20.75	10.01	3.21
3000	16.89	34.99	9.81	22.92	3.64	1.08	20.25	9.55	3.24
3200	16.09	35.59	8.38	23.42	4.06	1.13	19.71	9.12	3.40
3400	15.25	35.90	7.28	24.94	4.40	1.18	19.25	8.72	3.60
3600	14.40	35.96	6.39	27.65	4.62	1.22	18.75	8.29	3.79
3800	13.51	36.08	5.61	27.33	4.88	1.27	18.26	7.84	3.99
4000	12.60	35.87	5.01	23.63	4.98	1.31	17.81	7.38	4.27
4200	11.74	35.92	4.48	20.31	5.18	1.34	17.45	6.98	4.48
4400	10.91	36.11	4.05	17.79	5.47	1.37	17.03	6.54	4.80
4600	10.05	35.82	3.68	15.56	5.46	1.38	16.61	6.17	5.07
4800	9.20	35.94	3.39	13.88	5.73	1.39	16.18	5.71	5.30
5000	8.38	35.82	3.13	12.58	5.84	1.39	15.54	5.39	5.56
5100	7.95	35.98	3.03	11.99	6.08	1.39	15.46	5.01	5.72
5200	7.51	35.73	2.89	11.52	6.00	1.39	15.06	4.73	5.86
5300	7.03	35.59	2.83	11.01	6.08	1.39	14.90	4.48	6.12
5400	6.51	35.21	2.72	10.60	5.99	1.39	14.60	4.03	6.33
5500	5.96	36.09	2.68	9.96	6.89	1.37	13.97	3.75	6.59

Typical Performance Data

Definitions:

Input Return Loss = -S11 (dB)

Gain(Power Gain) = S21 (dB)

Reverse Isolation = -S12 (dB)

Output Return Loss = -S22 (dB)

TEST CONDITIONS: Vd = 5.25V, Id = 34.25mA @ Temperature = +25°C

FREQ	Gain	Isolation	Input Return Loss	Output Return Loss	Stability		IP-3 Output	1dB Comp. Output	Noise Figure
					K	Measure			
(MHz)	(dB)	(dB)	(dB)	(dB)	K	Measure	(dBm)	(dBm)	(dB)
200	4.66	38.48	2.19	2.59	3.89	0.74	13.32	2.51	6.34
300	14.00	36.67	2.59	5.37	1.81	1.15	20.80	9.00	3.82
400	18.87	36.98	3.46	8.35	1.74	1.28	23.88	12.24	3.19
500	21.42	38.37	4.95	11.83	2.18	1.25	24.74	13.59	3.01
600	22.70	40.35	6.87	14.33	2.90	1.17	25.51	13.50	3.16
700	23.33	42.53	8.95	14.34	3.83	1.09	25.43	13.37	2.86
800	23.62	44.62	11.07	13.27	4.94	1.03	25.00	13.01	2.88
900	23.75	46.31	13.08	12.29	6.04	0.98	24.98	13.02	2.84
1000	23.78	47.26	14.86	11.58	6.77	0.95	24.00	12.27	2.81
1100	23.74	47.38	16.32	11.09	6.91	0.94	24.15	12.40	2.91
1200	23.67	46.81	17.23	10.77	6.53	0.92	23.76	12.08	2.86
1300	23.56	45.99	17.68	10.58	6.01	0.92	23.60	11.97	2.93
1400	23.41	45.13	17.78	10.46	5.53	0.91	23.60	11.95	2.87
1500	23.24	44.26	17.60	10.41	5.10	0.91	23.03	11.56	2.88
1600	23.05	43.51	17.41	10.44	4.79	0.91	23.03	11.62	2.89
1700	22.82	42.78	17.12	10.52	4.53	0.91	22.58	11.32	2.88
1800	22.57	42.16	16.88	10.67	4.35	0.92	22.78	11.48	2.90
1900	22.28	41.47	16.50	10.84	4.18	0.92	22.56	11.37	2.92
2000	21.98	40.96	16.17	11.08	4.09	0.92	22.04	11.05	2.90
2200	21.30	39.70	15.45	11.64	3.86	0.93	21.59	10.80	2.92
2400	20.53	38.26	14.53	12.55	3.62	0.95	21.98	11.01	3.04
2600	19.57	36.42	13.67	14.70	3.32	0.98	21.85	10.87	3.04
2800	18.42	35.11	12.16	18.44	3.26	1.02	21.47	10.50	3.12
3000	17.57	35.94	9.93	17.95	3.73	1.07	20.87	10.04	3.18
3200	16.73	36.75	8.36	18.12	4.26	1.12	20.40	9.62	3.36
3400	15.85	37.26	7.19	19.01	4.73	1.17	20.11	9.30	3.57
3600	14.97	37.41	6.27	20.74	5.04	1.22	19.65	8.93	3.74
3800	14.04	37.62	5.48	23.41	5.39	1.28	19.25	8.50	3.93
4000	13.11	37.36	4.87	27.48	5.50	1.32	18.77	8.11	4.20
4200	12.23	37.45	4.36	27.82	5.78	1.36	18.43	7.69	4.42
4400	11.39	37.66	3.93	24.32	6.13	1.40	18.05	7.29	4.69
4600	10.51	37.19	3.58	20.30	6.04	1.42	17.61	6.93	4.98
4800	9.65	37.27	3.29	17.59	6.34	1.44	17.21	6.49	5.21
5000	8.81	37.16	3.04	15.60	6.50	1.45	16.66	6.16	5.49
5100	8.36	37.36	2.94	14.71	6.81	1.45	16.52	5.80	5.63
5200	7.91	36.81	2.81	13.98	6.51	1.45	16.17	5.53	5.86
5300	7.42	36.86	2.74	13.23	6.75	1.45	15.96	5.24	6.04
5400	6.90	36.69	2.63	12.52	6.79	1.45	15.68	4.90	6.31
5500	6.34	37.43	2.60	11.65	7.73	1.43	15.11	4.60	6.55

Typical Performance Data

Definitions:

Input Return Loss = -S11 (dB)

Gain(Power Gain) = S21 (dB)

Reverse Isolation = -S12 (dB)

Output Return Loss = -S22 (dB)

TEST CONDITIONS: Vd = 5.00V, Id = 32.99mA @ Temperature = -45°C

FREQ	Gain	Isolation	Input Return Loss	Output Return Loss	Stability		IP-3 Output	1dB Comp. Output	Noise Figure
					K	Measure			
(MHz)	(dB)	(dB)	(dB)	(dB)	K	Measure	(dBm)	(dBm)	(dB)
200	4.83	38.40	2.09	2.57	3.62	0.74	13.15	2.25	5.46
300	14.31	36.51	2.46	5.39	1.63	1.17	20.68	8.78	3.11
400	19.20	36.83	3.28	8.25	1.55	1.29	23.81	11.90	2.56
500	21.78	38.23	4.74	11.46	1.98	1.26	24.84	13.12	2.43
600	23.06	40.22	6.59	13.58	2.66	1.17	25.54	12.98	2.55
700	23.69	42.42	8.54	13.66	3.55	1.09	25.35	12.84	2.30
800	24.01	44.58	10.55	12.79	4.62	1.03	24.93	12.48	2.30
900	24.15	46.46	12.41	11.77	5.77	0.98	24.95	12.47	2.29
1000	24.19	47.61	14.12	11.02	6.61	0.95	23.79	11.70	2.32
1100	24.18	47.92	15.52	10.51	6.88	0.93	24.00	11.87	2.31
1200	24.11	47.43	16.23	10.15	6.54	0.91	23.57	11.56	2.33
1300	24.02	46.60	16.49	9.96	6.00	0.91	23.47	11.50	2.35
1400	23.91	45.70	16.55	9.90	5.48	0.90	23.41	11.51	2.32
1500	23.76	44.77	16.44	9.90	5.01	0.90	22.85	11.12	2.30
1600	23.60	43.96	16.32	9.95	4.66	0.90	22.90	11.22	2.31
1700	23.39	43.18	16.06	10.05	4.38	0.90	22.43	10.94	2.31
1800	23.18	42.50	15.87	10.22	4.17	0.91	22.72	11.13	2.31
1900	22.91	41.76	15.54	10.38	3.97	0.91	22.46	11.02	2.32
2000	22.62	41.22	15.20	10.62	3.87	0.92	21.96	10.76	2.33
2200	21.97	39.89	14.66	11.20	3.62	0.93	21.47	10.50	2.34
2400	21.22	38.40	13.91	12.03	3.37	0.94	21.90	10.74	2.42
2600	20.27	36.52	13.20	13.93	3.09	0.97	21.85	10.68	2.44
2800	19.06	35.05	11.93	18.04	3.01	1.01	21.60	10.37	2.50
3000	18.17	35.97	9.55	17.35	3.45	1.07	20.99	9.97	2.55
3200	17.38	36.95	8.00	17.28	3.98	1.13	20.40	9.50	2.65
3400	16.53	37.46	6.96	18.14	4.41	1.18	19.97	9.21	2.89
3600	15.69	37.66	6.15	19.56	4.72	1.23	19.51	8.78	2.98
3800	14.79	37.82	5.41	21.55	5.02	1.28	19.14	8.38	3.17
4000	13.83	37.50	4.79	25.13	5.08	1.33	18.62	8.00	3.36
4200	12.98	37.71	4.28	27.13	5.39	1.37	18.29	7.62	3.58
4400	12.14	37.84	3.81	25.51	5.63	1.41	17.91	7.16	3.78
4600	11.29	37.40	3.48	21.90	5.56	1.44	17.50	6.77	4.07
4800	10.45	37.45	3.19	18.77	5.80	1.45	17.09	6.34	4.32
5000	9.64	37.28	2.97	16.69	5.92	1.47	16.55	6.05	4.54
5100	9.22	37.37	2.86	16.02	6.11	1.47	16.41	5.72	4.68
5200	8.76	36.91	2.69	15.36	5.85	1.48	16.08	5.46	4.87
5300	8.25	36.84	2.58	14.49	5.94	1.49	15.88	5.18	5.10
5400	7.71	36.61	2.47	13.67	5.93	1.49	15.58	4.76	5.30
5500	7.16	37.17	2.45	12.79	6.65	1.47	14.96	4.47	5.57

Typical Performance Data

Definitions:

Input Return Loss = -S11 (dB)

Gain(Power Gain) = S21 (dB)

Reverse Isolation = -S12 (dB)

Output Return Loss = -S22 (dB)

TEST CONDITIONS: Vd = 3.90V, Id = 32.50mA @ Temperature = -45°C

FREQ	Gain	Isolation	Input Return Loss	Output Return Loss	Stability		IP-3 Output	1dB Comp. Output	Noise Figure
					K	Measure			
(MHz)	(dB)	(dB)	(dB)	(dB)			(dBm)	(dBm)	(dB)
200	4.75	38.42	2.10	2.58	3.68	0.74	12.88	2.08	5.46
300	14.18	36.63	2.46	5.38	1.68	1.17	20.37	8.52	3.15
400	19.03	37.05	3.31	8.26	1.65	1.29	23.46	11.63	2.57
500	21.55	38.57	4.80	11.63	2.14	1.26	24.32	12.87	2.40
600	22.78	40.68	6.66	14.14	2.93	1.18	24.85	12.79	2.58
700	23.39	42.98	8.66	14.64	3.97	1.10	24.93	12.64	2.30
800	23.67	45.13	10.65	13.78	5.19	1.04	24.44	12.28	2.33
900	23.78	46.78	12.52	12.73	6.34	1.00	24.40	12.28	2.30
1000	23.81	47.47	14.28	11.96	6.92	0.96	23.47	11.50	2.28
1100	23.76	47.23	15.68	11.36	6.79	0.94	23.59	11.67	2.29
1200	23.67	46.37	16.47	10.97	6.21	0.93	23.23	11.37	2.31
1300	23.57	45.36	16.77	10.80	5.60	0.92	23.12	11.31	2.34
1400	23.42	44.38	16.80	10.71	5.09	0.92	23.01	11.30	2.28
1500	23.26	43.44	16.72	10.68	4.66	0.92	22.49	10.92	2.31
1600	23.08	42.60	16.56	10.73	4.33	0.92	22.56	11.02	2.29
1700	22.86	41.80	16.22	10.82	4.06	0.92	22.09	10.73	2.32
1800	22.63	41.13	16.00	10.95	3.87	0.92	22.39	10.92	2.32
1900	22.35	40.40	15.60	11.11	3.68	0.92	22.17	10.81	2.34
2000	22.06	39.83	15.20	11.34	3.58	0.93	21.69	10.53	2.34
2200	21.42	38.51	14.57	11.87	3.34	0.94	21.17	10.29	2.33
2400	20.68	37.03	13.82	12.69	3.10	0.95	21.51	10.55	2.46
2600	19.74	35.26	13.13	14.78	2.87	0.97	21.44	10.47	2.45
2800	18.56	34.40	11.58	19.81	2.95	1.03	21.01	10.19	2.53
3000	17.75	35.62	9.39	18.93	3.49	1.08	20.47	9.73	2.58
3200	16.99	36.42	8.03	19.09	3.95	1.13	20.01	9.22	2.69
3400	16.18	36.75	7.06	20.44	4.29	1.18	19.57	8.90	2.91
3600	15.37	36.80	6.30	22.62	4.52	1.22	19.11	8.48	3.04
3800	14.50	36.86	5.58	25.86	4.75	1.27	18.68	8.05	3.20
4000	13.60	36.52	4.97	30.41	4.79	1.31	18.18	7.57	3.44
4200	12.77	36.67	4.44	26.72	5.03	1.35	17.84	7.18	3.66
4400	11.95	36.75	3.96	22.04	5.20	1.39	17.46	6.75	3.84
4600	11.12	36.37	3.62	18.85	5.16	1.41	17.08	6.39	4.13
4800	10.30	36.46	3.33	16.35	5.39	1.42	16.65	5.94	4.37
5000	9.52	36.29	3.10	14.66	5.49	1.43	16.12	5.62	4.60
5100	9.11	36.43	3.00	14.11	5.69	1.43	15.95	5.28	4.72
5200	8.66	35.98	2.82	13.53	5.44	1.44	15.63	5.00	4.94
5300	8.16	36.02	2.70	12.79	5.58	1.44	15.42	4.72	5.10
5400	7.63	35.80	2.59	12.08	5.58	1.44	15.08	4.29	5.29
5500	7.07	36.30	2.58	11.31	6.21	1.42	14.47	3.97	5.55

Typical Performance Data

Definitions:

Input Return Loss = -S11 (dB)

Gain(Power Gain) = S21 (dB)

Reverse Isolation = -S12 (dB)

Output Return Loss = -S22 (dB)

TEST CONDITIONS: Vd = 5.25V, Id = 33.05mA @ Temperature = -45°C

FREQ	Gain	Isolation	Input Return Loss	Output Return Loss	Stability		IP-3 Output	1dB Comp. Output	Noise Figure
					K	Measure			
(MHz)	(dB)	(dB)	(dB)	(dB)	K	Measure	(dBm)	(dBm)	(dB)
200	4.85	38.39	2.09	2.57	3.60	0.74	13.20	2.29	5.39
300	14.33	36.50	2.46	5.39	1.62	1.17	20.73	8.81	3.13
400	19.24	36.79	3.28	8.25	1.54	1.29	23.77	11.94	2.57
500	21.82	38.17	4.73	11.44	1.96	1.26	24.88	13.15	2.39
600	23.10	40.15	6.56	13.47	2.62	1.17	25.42	13.05	2.55
700	23.75	42.34	8.53	13.57	3.48	1.09	25.39	12.90	2.31
800	24.06	44.50	10.51	12.63	4.54	1.03	24.93	12.54	2.28
900	24.21	46.38	12.38	11.65	5.67	0.98	24.91	12.56	2.26
1000	24.26	47.62	14.12	10.93	6.56	0.95	23.86	11.77	2.32
1100	24.24	48.01	15.46	10.39	6.88	0.93	24.02	11.91	2.34
1200	24.18	47.60	16.20	10.04	6.60	0.91	23.64	11.61	2.29
1300	24.09	46.81	16.45	9.89	6.08	0.91	23.53	11.56	2.36
1400	23.98	45.94	16.47	9.82	5.57	0.90	23.45	11.57	2.29
1500	23.83	45.02	16.42	9.81	5.11	0.90	22.91	11.18	2.28
1600	23.68	44.22	16.28	9.88	4.75	0.90	22.94	11.28	2.30
1700	23.47	43.43	16.01	9.98	4.46	0.90	22.51	11.00	2.33
1800	23.25	42.75	15.87	10.14	4.25	0.91	22.79	11.19	2.31
1900	22.98	42.05	15.54	10.32	4.06	0.91	22.50	11.10	2.34
2000	22.70	41.49	15.18	10.56	3.95	0.92	22.02	10.82	2.32
2200	22.05	40.21	14.63	11.13	3.71	0.93	21.53	10.54	2.32
2400	21.29	38.73	13.85	11.94	3.46	0.94	21.97	10.80	2.43
2600	20.35	36.82	13.15	13.73	3.16	0.97	21.94	10.72	2.45
2800	19.15	35.19	11.92	17.47	3.02	1.01	21.57	10.41	2.49
3000	18.25	36.01	9.56	16.96	3.44	1.07	20.98	10.04	2.56
3200	17.46	37.00	7.99	17.03	3.96	1.13	20.45	9.53	2.70
3400	16.59	37.55	6.93	17.84	4.41	1.18	20.07	9.22	2.85
3600	15.73	37.75	6.11	19.24	4.72	1.23	19.65	8.84	2.99
3800	14.82	37.93	5.38	21.17	5.04	1.28	19.28	8.42	3.12
4000	13.88	37.59	4.77	24.60	5.09	1.33	18.77	7.99	3.41
4200	13.01	37.80	4.24	27.05	5.40	1.37	18.41	7.60	3.58
4400	12.17	37.95	3.78	25.93	5.64	1.41	18.05	7.23	3.81
4600	11.31	37.53	3.44	22.44	5.60	1.44	17.63	6.81	4.10
4800	10.47	37.59	3.16	19.15	5.85	1.46	17.23	6.37	4.32
5000	9.66	37.40	2.93	17.04	5.95	1.47	16.69	6.12	4.57
5100	9.23	37.51	2.82	16.36	6.15	1.48	16.56	5.75	4.69
5200	8.77	37.00	2.66	15.63	5.87	1.49	16.24	5.43	4.86
5300	8.26	36.93	2.54	14.73	5.93	1.50	16.05	5.24	5.06
5400	7.72	36.68	2.42	13.89	5.91	1.50	15.72	4.84	5.31
5500	7.16	37.25	2.41	12.99	6.64	1.48	15.12	4.54	5.53

Typical Performance Data

Definitions:

Input Return Loss = -S11 (dB)

Gain(Power Gain) = S21 (dB)

Reverse Isolation = -S12 (dB)

Output Return Loss = -S22 (dB)

TEST CONDITIONS: Vd = 5.00V, Id = 34.92mA @ Temperature = +85°C

FREQ	Gain	Isolation	Input Return Loss	Output Return Loss	Stability		IP-3 Output	1dB Comp. Output	Noise Figure
					K	Measure			
(MHz)	(dB)	(dB)	(dB)	(dB)	K	Measure	(dBm)	(dBm)	(dB)
200	4.36	38.52	2.30	2.61	4.26	0.74	13.16	2.43	6.95
300	13.56	36.70	2.75	5.42	2.06	1.14	20.59	8.84	4.47
400	18.32	37.01	3.66	8.49	1.96	1.26	23.75	12.14	3.78
500	20.86	38.36	5.18	12.19	2.40	1.24	24.60	13.55	3.57
600	22.13	40.26	7.14	15.03	3.13	1.16	25.51	13.50	3.56
700	22.76	42.34	9.31	14.96	4.07	1.08	25.41	13.37	3.40
800	23.05	44.31	11.63	13.64	5.16	1.02	24.89	13.03	3.35
900	23.17	45.86	13.94	12.51	6.21	0.98	24.94	13.03	3.37
1000	23.18	46.63	16.11	11.73	6.82	0.95	23.90	12.28	3.40
1100	23.12	46.65	17.93	11.19	6.89	0.93	24.09	12.41	3.43
1200	23.02	46.13	19.05	10.85	6.55	0.92	23.66	12.11	3.41
1300	22.88	45.32	19.47	10.65	6.05	0.91	23.53	11.98	3.46
1400	22.71	44.54	19.42	10.53	5.63	0.91	23.38	11.95	3.38
1500	22.52	43.74	19.11	10.49	5.25	0.91	22.87	11.61	3.41
1600	22.31	43.01	18.88	10.53	4.95	0.91	22.92	11.62	3.39
1700	22.06	42.32	18.58	10.62	4.72	0.91	22.49	11.35	3.40
1800	21.79	41.70	18.41	10.76	4.54	0.91	22.67	11.47	3.44
1900	21.50	41.09	18.14	10.94	4.40	0.92	22.42	11.34	3.46
2000	21.19	40.58	17.99	11.14	4.32	0.92	21.88	11.05	3.45
2200	20.49	39.39	17.16	11.71	4.12	0.93	21.47	10.76	3.48
2400	19.70	37.99	15.99	12.62	3.88	0.95	21.79	10.89	3.63
2600	18.73	36.14	14.74	14.74	3.57	0.97	21.63	10.64	3.63
2800	17.62	35.19	12.61	17.93	3.60	1.01	21.29	10.30	3.72
3000	16.78	36.07	10.22	17.48	4.16	1.06	20.67	9.85	3.81
3200	15.95	36.72	8.58	17.72	4.67	1.11	20.17	9.44	3.93
3400	15.03	37.12	7.34	19.16	5.15	1.17	19.78	9.05	4.20
3600	14.10	37.35	6.33	21.28	5.55	1.22	19.34	8.70	4.42
3800	13.17	37.53	5.51	24.53	5.92	1.28	18.94	8.28	4.62
4000	12.25	37.28	4.90	29.58	6.04	1.32	18.47	7.86	4.91
4200	11.36	37.38	4.38	27.76	6.36	1.36	18.11	7.45	5.16
4400	10.50	37.62	3.94	23.53	6.77	1.39	17.70	7.04	5.44
4600	9.61	37.48	3.60	19.77	6.95	1.42	17.26	6.67	5.79
4800	8.73	37.59	3.32	16.94	7.34	1.43	16.83	6.20	6.06
5000	7.88	37.71	3.08	14.99	7.75	1.44	16.25	5.83	6.37
5100	7.42	37.63	2.99	14.11	7.87	1.44	16.16	5.46	6.55
5200	6.95	37.42	2.89	13.31	7.90	1.43	15.76	5.26	6.75
5300	6.43	37.88	2.84	12.49	8.63	1.43	15.53	4.98	7.01
5400	5.89	37.66	2.77	11.57	8.70	1.41	15.31	4.50	7.23
5500	5.39	37.13	2.69	10.58	8.37	1.39	14.70	4.23	7.50

Typical Performance Data

Definitions:

Input Return Loss = -S11 (dB)

Gain(Power Gain) = S21 (dB)

Reverse Isolation = -S12 (dB)

Output Return Loss = -S22 (dB)

TEST CONDITIONS: Vd = 3.90V, Id = 34.06mA @ Temperature = +85°C

FREQ	Gain	Isolation	Input Return Loss	Output Return Loss	Stability		IP-3 Output	1dB Comp. Output	Noise Figure
					K	Measure			
(MHz)	(dB)	(dB)	(dB)	(dB)	K	Measure	(dBm)	(dBm)	(dB)
200	4.24	38.62	2.31	2.64	4.43	0.74	12.66	2.08	7.06
300	13.36	36.98	2.76	5.41	2.20	1.13	19.93	8.40	4.45
400	18.06	37.45	3.70	8.49	2.16	1.25	23.04	11.61	3.80
500	20.53	38.95	5.27	12.47	2.72	1.23	24.04	13.01	3.61
600	21.75	40.99	7.28	16.44	3.63	1.16	24.59	13.05	3.57
700	22.34	43.13	9.49	17.47	4.78	1.09	24.56	12.94	3.41
800	22.59	44.93	11.85	16.14	5.99	1.04	24.14	12.61	3.43
900	22.67	45.95	14.21	14.80	6.82	1.00	24.07	12.62	3.37
1000	22.66	46.01	16.48	13.85	6.95	0.97	23.21	11.93	3.38
1100	22.57	45.47	18.43	13.23	6.62	0.96	23.33	12.04	3.43
1200	22.44	44.59	19.70	12.84	6.07	0.95	23.01	11.75	3.43
1300	22.27	43.68	20.21	12.61	5.57	0.94	22.88	11.64	3.46
1400	22.08	42.85	20.13	12.48	5.17	0.94	22.72	11.60	3.44
1500	21.86	42.05	19.74	12.46	4.83	0.94	22.24	11.23	3.44
1600	21.63	41.35	19.39	12.51	4.59	0.94	22.24	11.27	3.44
1700	21.36	40.68	19.00	12.62	4.39	0.94	21.90	10.99	3.46
1800	21.08	40.10	18.68	12.78	4.25	0.94	22.08	11.06	3.48
1900	20.78	39.52	18.28	13.01	4.13	0.95	21.80	10.94	3.51
2000	20.47	39.03	17.99	13.25	4.05	0.95	21.31	10.64	3.51
2200	19.76	37.93	17.01	13.93	3.90	0.96	20.90	10.33	3.51
2400	18.99	36.64	15.81	15.03	3.69	0.97	21.08	10.40	3.62
2600	18.04	35.03	14.56	17.73	3.45	0.99	20.88	10.13	3.67
2800	16.97	34.30	12.48	22.56	3.53	1.03	20.49	9.72	3.81
3000	16.17	35.09	10.23	21.81	4.03	1.07	19.90	9.22	3.87
3200	15.36	35.58	8.68	22.40	4.45	1.12	19.38	8.81	4.03
3400	14.47	35.86	7.45	24.78	4.83	1.17	18.92	8.42	4.31
3600	13.57	36.02	6.45	27.61	5.15	1.22	18.43	7.98	4.50
3800	12.65	36.17	5.62	27.16	5.44	1.27	17.96	7.52	4.73
4000	11.74	35.97	5.01	23.48	5.56	1.31	17.53	7.11	5.01
4200	10.86	36.08	4.47	20.15	5.83	1.34	17.14	6.70	5.26
4400	10.02	36.30	4.02	17.77	6.17	1.37	16.72	6.25	5.57
4600	9.14	36.23	3.67	15.61	6.35	1.38	16.30	5.88	5.90
4800	8.26	36.40	3.38	13.84	6.71	1.39	15.85	5.33	6.19
5000	7.42	36.51	3.14	12.53	7.05	1.39	15.19	5.04	6.50
5100	6.97	36.49	3.03	11.93	7.20	1.39	15.15	4.65	6.64
5200	6.50	36.34	2.95	11.39	7.27	1.39	14.75	4.40	6.84
5300	6.00	36.79	2.88	10.84	7.90	1.38	14.54	4.09	7.11
5400	5.46	36.70	2.81	10.20	8.08	1.37	14.31	3.62	7.37
5500	4.95	36.17	2.73	9.46	7.78	1.35	13.66	3.40	7.58

Typical Performance Data

Definitions:

Input Return Loss = -S11 (dB)

Gain(Power Gain) = S21 (dB)

Reverse Isolation = -S12 (dB)

Output Return Loss = -S22 (dB)

TEST CONDITIONS: Vd = 5.25V, Id = 35.08mA @ Temperature = +85°C

FREQ	Gain	Isolation	Input Return Loss	Output Return Loss	Stability		IP-3 Output	1dB Comp. Output	Noise Figure
					K	Measure			
(MHz)	(dB)	(dB)	(dB)	(dB)	K	Measure	(dBm)	(dBm)	(dB)
200	4.37	38.51	2.30	2.60	4.24	0.73	13.21	2.43	6.95
300	13.58	36.66	2.75	5.42	2.04	1.14	20.61	8.91	4.43
400	18.36	36.96	3.65	8.49	1.93	1.26	23.83	12.23	3.78
500	20.90	38.27	5.17	12.15	2.36	1.24	24.66	13.63	3.55
600	22.18	40.15	7.12	14.84	3.07	1.16	25.41	13.57	3.55
700	22.82	42.23	9.28	14.65	3.98	1.08	25.45	13.44	3.42
800	23.11	44.21	11.60	13.35	5.05	1.02	24.96	13.09	3.40
900	23.23	45.81	13.91	12.24	6.10	0.97	24.88	13.09	3.36
1000	23.24	46.68	16.07	11.46	6.78	0.94	23.96	12.33	3.35
1100	23.19	46.82	17.88	10.94	6.93	0.93	24.12	12.44	3.41
1200	23.09	46.35	18.97	10.61	6.62	0.92	23.78	12.13	3.38
1300	22.96	45.60	19.35	10.40	6.15	0.91	23.60	12.02	3.42
1400	22.79	44.82	19.31	10.28	5.72	0.91	23.47	12.00	3.40
1500	22.60	44.01	19.02	10.25	5.33	0.90	22.96	11.63	3.40
1600	22.39	43.30	18.77	10.29	5.04	0.91	23.00	11.69	3.43
1700	22.14	42.60	18.50	10.38	4.80	0.91	22.61	11.41	3.42
1800	21.88	41.99	18.32	10.51	4.62	0.91	22.77	11.52	3.43
1900	21.58	41.36	18.10	10.70	4.47	0.91	22.46	11.39	3.43
2000	21.28	40.87	17.95	10.90	4.39	0.92	21.97	11.10	3.45
2200	20.58	39.68	17.14	11.46	4.19	0.93	21.48	10.81	3.45
2400	19.79	38.24	16.00	12.35	3.94	0.94	21.88	10.96	3.56
2600	18.81	36.34	14.76	14.40	3.61	0.97	21.71	10.72	3.61
2800	17.70	35.32	12.63	17.43	3.62	1.01	21.37	10.38	3.74
3000	16.85	36.20	10.22	17.02	4.18	1.06	20.71	9.87	3.79
3200	16.01	36.88	8.58	17.23	4.71	1.11	20.27	9.49	3.97
3400	15.09	37.29	7.32	18.56	5.20	1.16	19.90	9.14	4.18
3600	14.16	37.54	6.31	20.52	5.62	1.22	19.46	8.79	4.39
3800	13.22	37.73	5.49	23.58	6.00	1.28	19.06	8.36	4.61
4000	12.29	37.47	4.88	29.04	6.12	1.32	18.59	7.96	4.91
4200	11.40	37.59	4.36	29.42	6.46	1.36	18.24	7.54	5.14
4400	10.54	37.84	3.93	24.94	6.90	1.40	17.85	7.15	5.45
4600	9.65	37.67	3.59	20.64	7.07	1.42	17.41	6.78	5.80
4800	8.77	37.78	3.30	17.54	7.46	1.44	16.99	6.31	6.07
5000	7.91	37.89	3.07	15.42	7.88	1.44	16.40	5.97	6.38
5100	7.45	37.83	2.97	14.48	8.02	1.44	16.32	5.59	6.55
5200	6.97	37.62	2.89	13.61	8.07	1.44	15.94	5.31	6.79
5300	6.46	38.03	2.82	12.75	8.74	1.43	15.67	5.09	7.00
5400	5.92	37.81	2.76	11.78	8.83	1.42	15.46	4.60	7.23
5500	5.42	37.33	2.68	10.74	8.53	1.40	14.88	4.35	7.55

Typical Performance Data

Definitions:

Input Return Loss = -S11 (dB)

Gain(Power Gain) = S21 (dB)

Reverse Isolation = -S12 (dB)

Output Return Loss = -S22 (dB)

TEST CONDITIONS: Vd = 2.80V, Id = 32.48mA @ Temperature = +25°C

FREQ	Gain	Isolation	Input Return Loss	Output Return Loss	Stability		IP-3 Output	1dB Comp. Output	Noise Figure
					K	Measure			
(MHz)	(dB)	(dB)	(dB)	(dB)	K	Measure	(dBm)	(dBm)	(dB)
200	4.24	38.73	2.22	2.66	4.35	0.75	12.06	1.74	6.54
300	13.34	37.37	2.60	5.33	2.21	1.14	18.86	7.68	3.92
400	18.00	38.14	3.58	8.37	2.32	1.25	21.59	10.45	3.30
500	20.35	40.04	5.25	12.42	3.16	1.23	22.48	11.45	3.09
600	21.46	42.42	7.35	17.34	4.47	1.16	22.90	11.68	3.27
700	21.96	44.63	9.58	21.59	6.02	1.10	22.82	11.63	2.92
800	22.16	45.92	11.84	21.79	7.18	1.06	22.58	11.47	2.96
900	22.20	45.94	14.04	20.11	7.35	1.02	22.51	11.39	2.89
1000	22.15	45.07	16.10	18.76	6.78	1.00	21.82	10.98	2.92
1100	22.04	44.00	17.90	17.86	6.12	0.99	21.94	11.01	2.95
1200	21.90	42.86	19.16	17.33	5.48	0.98	21.70	10.80	2.98
1300	21.72	41.87	19.89	17.02	5.00	0.98	21.52	10.71	3.00
1400	21.51	41.01	20.08	16.85	4.64	0.97	21.35	10.63	2.96
1500	21.28	40.20	19.80	16.80	4.35	0.97	21.00	10.37	2.94
1600	21.04	39.53	19.43	16.88	4.14	0.97	20.99	10.36	2.99
1700	20.76	38.87	18.90	17.05	3.97	0.97	20.70	10.11	3.01
1800	20.48	38.31	18.39	17.31	3.85	0.98	20.86	10.16	2.96
1900	20.16	37.70	17.73	17.62	3.72	0.98	20.59	10.07	3.02
2000	19.83	37.23	17.12	18.04	3.66	0.98	20.32	9.83	3.02
2200	19.14	36.15	15.92	19.07	3.50	0.99	19.88	9.54	3.04
2400	18.37	34.97	14.71	20.84	3.33	1.00	19.87	9.44	3.19
2600	17.43	33.62	13.49	25.66	3.16	1.01	19.70	9.21	3.23
2800	16.38	33.16	11.61	36.34	3.28	1.05	19.28	8.83	3.30
3000	15.60	33.94	9.71	28.35	3.73	1.09	18.76	8.39	3.38
3200	14.81	34.32	8.36	26.90	4.06	1.14	18.22	7.94	3.58
3400	13.96	34.48	7.28	24.35	4.32	1.18	17.69	7.47	3.78
3600	13.11	34.47	6.38	21.92	4.49	1.22	17.18	7.00	3.99
3800	12.22	34.55	5.61	19.13	4.70	1.26	16.61	6.50	4.20
4000	11.32	34.39	4.99	16.72	4.78	1.29	16.21	6.11	4.54
4200	10.47	34.45	4.47	14.89	4.95	1.31	15.85	5.61	4.72
4400	9.64	34.63	4.03	13.41	5.19	1.33	15.42	5.22	4.95
4600	8.78	34.43	3.66	12.05	5.21	1.33	15.03	4.84	5.37
4800	7.94	34.60	3.37	10.96	5.46	1.33	14.59	4.41	5.60
5000	7.13	34.55	3.11	10.09	5.59	1.33	13.88	4.09	5.83
5100	6.70	34.76	3.02	9.71	5.84	1.32	13.85	3.71	6.00
5200	6.27	34.30	2.88	9.38	5.61	1.32	13.44	3.44	6.24
5300	5.80	34.51	2.82	9.07	5.92	1.32	13.30	3.18	6.39
5400	5.29	34.39	2.72	8.77	6.00	1.31	12.97	2.73	6.63
5500	4.74	34.93	2.68	8.39	6.64	1.30	12.27	2.42	6.81

Typical Performance Data

Definitions:

Input Return Loss = -S11 (dB)

Gain(Power Gain) = S21 (dB)

Reverse Isolation = -S12 (dB)

Output Return Loss = -S22 (dB)

TEST CONDITIONS: Vd = 2.66V, Id = 32.39mA @ Temperature = +25°C

FREQ	Gain	Isolation	Input Return Loss	Output Return Loss	Stability		IP-3 Output	1dB Comp. Output	Noise Figure
					K	Measure			
(MHz)	(dB)	(dB)	(dB)	(dB)	K	Measure	(dBm)	(dBm)	(dB)
200	4.19	38.75	2.22	2.66	4.40	0.75	11.81	1.59	6.50
300	13.26	37.43	2.60	5.33	2.24	1.14	18.58	7.35	3.96
400	17.90	38.25	3.59	8.37	2.38	1.25	21.19	9.99	3.29
500	20.23	40.19	5.28	12.43	3.27	1.23	22.05	10.93	3.12
600	21.31	42.60	7.39	17.47	4.65	1.16	22.43	11.22	3.24
700	21.80	44.80	9.63	22.31	6.26	1.10	22.40	11.19	3.00
800	21.99	45.95	11.91	23.05	7.37	1.06	22.16	11.08	2.94
900	22.02	45.81	14.10	21.20	7.42	1.03	22.09	11.00	2.95
1000	21.97	44.86	16.16	19.70	6.79	1.01	21.45	10.67	2.92
1100	21.85	43.74	18.01	18.72	6.09	0.99	21.54	10.64	2.98
1200	21.70	42.62	19.28	18.14	5.47	0.99	21.30	10.48	2.98
1300	21.51	41.63	20.03	17.82	5.00	0.98	21.17	10.44	2.99
1400	21.30	40.78	20.23	17.63	4.65	0.98	21.01	10.31	2.96
1500	21.07	39.97	19.99	17.59	4.36	0.98	20.68	10.09	2.98
1600	20.82	39.31	19.61	17.68	4.16	0.98	20.63	10.05	3.01
1700	20.54	38.65	19.02	17.86	3.98	0.98	20.38	9.83	3.00
1800	20.25	38.10	18.47	18.16	3.87	0.98	20.53	9.84	3.01
1900	19.93	37.50	17.79	18.49	3.74	0.98	20.28	9.75	3.05
2000	19.61	37.03	17.15	18.95	3.68	0.98	20.07	9.56	3.05
2200	18.91	35.96	15.89	20.07	3.52	0.99	19.60	9.26	3.04
2400	18.14	34.79	14.63	21.99	3.35	1.00	19.56	9.13	3.22
2600	17.20	33.48	13.38	27.00	3.19	1.02	19.40	8.86	3.24
2800	16.16	33.04	11.51	32.37	3.31	1.05	18.98	8.48	3.33
3000	15.39	33.80	9.65	27.45	3.75	1.10	18.44	8.05	3.44
3200	14.59	34.15	8.32	25.85	4.07	1.14	17.95	7.62	3.62
3400	13.75	34.29	7.24	23.31	4.32	1.18	17.37	7.13	3.81
3600	12.90	34.28	6.36	20.96	4.48	1.22	16.83	6.66	4.01
3800	12.02	34.35	5.59	18.38	4.68	1.25	16.27	6.11	4.26
4000	11.11	34.20	4.98	16.13	4.77	1.28	15.90	5.78	4.52
4200	10.26	34.25	4.45	14.40	4.93	1.30	15.54	5.28	4.74
4400	9.43	34.42	4.02	12.99	5.15	1.32	15.10	4.83	5.04
4600	8.57	34.24	3.65	11.69	5.18	1.32	14.73	4.51	5.35
4800	7.74	34.43	3.36	10.65	5.44	1.32	14.27	4.09	5.60
5000	6.93	34.36	3.11	9.81	5.55	1.32	13.56	3.76	5.93
5100	6.51	34.57	3.01	9.45	5.79	1.32	13.55	3.39	6.01
5200	6.08	34.10	2.88	9.14	5.57	1.31	13.13	3.12	6.15
5300	5.61	34.34	2.82	8.84	5.89	1.31	13.00	2.88	6.48
5400	5.10	34.19	2.72	8.55	5.94	1.30	12.67	2.33	6.70
5500	4.55	34.73	2.68	8.19	6.58	1.29	11.94	2.11	6.86

Typical Performance Data

Definitions:

Input Return Loss = -S11 (dB)

Gain(Power Gain) = S21 (dB)

Reverse Isolation = -S12 (dB)

Output Return Loss = -S22 (dB)

TEST CONDITIONS: Vd = 3.30V, Id = 33.37mA @ Temperature = +25°C

FREQ	Gain	Isolation	Input Return Loss	Output Return Loss	Stability		IP-3 Output	1dB Comp. Output	Noise Figure
					K	Measure			
(MHz)	(dB)	(dB)	(dB)	(dB)	K	Measure	(dBm)	(dBm)	(dB)
200	4.44	38.66	2.20	2.64	4.16	0.75	12.72	2.13	6.30
300	13.63	37.18	2.58	5.33	2.04	1.14	19.67	8.27	3.89
400	18.36	37.83	3.51	8.35	2.09	1.26	22.66	11.34	3.25
500	20.77	39.60	5.13	12.30	2.81	1.24	23.52	12.55	2.98
600	21.93	41.91	7.15	16.68	3.93	1.17	23.95	12.58	3.21
700	22.47	44.21	9.32	19.13	5.34	1.10	23.88	12.48	2.95
800	22.69	45.89	11.51	18.49	6.65	1.05	23.54	12.21	2.91
900	22.75	46.42	13.59	17.15	7.19	1.02	23.49	12.18	2.86
1000	22.73	45.91	15.48	16.12	6.89	1.00	22.67	11.56	2.90
1100	22.64	44.95	17.10	15.42	6.28	0.98	22.82	11.68	2.93
1200	22.51	43.85	18.16	14.98	5.63	0.97	22.53	11.41	2.92
1300	22.35	42.83	18.72	14.72	5.10	0.97	22.35	11.30	2.95
1400	22.16	41.94	18.84	14.56	4.72	0.96	22.20	11.26	2.90
1500	21.95	41.10	18.61	14.51	4.39	0.96	21.80	10.92	2.91
1600	21.72	40.39	18.31	14.56	4.16	0.96	21.78	10.95	2.94
1700	21.46	39.70	17.84	14.67	3.96	0.96	21.44	10.64	2.92
1800	21.18	39.12	17.42	14.88	3.83	0.96	21.65	10.75	2.93
1900	20.88	38.48	16.86	15.10	3.69	0.97	21.40	10.63	2.97
2000	20.56	37.98	16.35	15.43	3.61	0.97	21.02	10.35	2.97
2200	19.87	36.84	15.38	16.23	3.44	0.98	20.57	10.04	2.98
2400	19.11	35.57	14.37	17.61	3.25	0.99	20.72	10.11	3.14
2600	18.15	34.11	13.40	21.43	3.07	1.01	20.62	9.95	3.16
2800	17.06	33.53	11.66	34.82	3.18	1.04	20.32	9.58	3.25
3000	16.29	34.39	9.71	27.62	3.64	1.09	19.76	9.14	3.30
3200	15.50	34.89	8.35	27.75	4.01	1.14	19.12	8.64	3.52
3400	14.66	35.12	7.27	27.43	4.31	1.18	18.58	8.21	3.72
3600	13.83	35.13	6.39	26.12	4.49	1.22	18.04	7.78	3.84
3800	12.94	35.22	5.63	22.61	4.71	1.26	17.50	7.26	4.12
4000	12.03	35.03	5.02	19.42	4.80	1.30	17.09	6.82	4.37
4200	11.19	35.08	4.50	17.05	4.98	1.32	16.72	6.39	4.58
4400	10.37	35.25	4.08	15.19	5.23	1.34	16.29	5.96	4.86
4600	9.51	35.02	3.70	13.50	5.24	1.35	15.89	5.54	5.21
4800	8.67	35.18	3.41	12.19	5.50	1.36	15.44	5.12	5.38
5000	7.86	35.10	3.14	11.15	5.62	1.36	14.75	4.80	5.69
5100	7.43	35.30	3.05	10.70	5.88	1.35	14.71	4.41	5.79
5200	6.99	34.82	2.92	10.30	5.65	1.35	14.29	4.14	6.01
5300	6.52	35.03	2.85	9.92	5.96	1.35	14.14	3.85	6.25
5400	6.00	34.87	2.76	9.58	6.03	1.35	13.82	3.40	6.47
5500	5.46	35.49	2.71	9.12	6.72	1.33	13.14	3.17	6.73

Typical Performance Data

Definitions:

Input Return Loss = -S11 (dB)

Gain(Power Gain) = S21 (dB)

Reverse Isolation = -S12 (dB)

Output Return Loss = -S22 (dB)

TEST CONDITIONS: Vd = 2.80V, Id = 31.83mA @ Temperature = -45°C

FREQ	Gain	Isolation	Input Return Loss	Output Return Loss	Stability		IP-3 Output	1dB Comp. Output	Noise Figure
					K	Measure			
(MHz)	(dB)	(dB)	(dB)	(dB)	K	Measure	(dBm)	(dBm)	(dB)
200	4.46	38.57	2.13	2.63	3.98	0.75	12.17	1.68	5.50
300	13.74	37.04	2.50	5.38	1.93	1.16	19.03	7.75	3.18
400	18.45	37.71	3.41	8.34	1.99	1.27	21.64	10.56	2.64
500	20.84	39.51	5.02	12.17	2.71	1.25	22.33	11.53	2.44
600	21.97	41.87	6.99	16.16	3.85	1.17	22.75	11.71	2.58
700	22.49	44.25	9.06	18.46	5.29	1.11	22.67	11.63	2.36
800	22.72	46.04	11.17	18.13	6.68	1.06	22.43	11.46	2.34
900	22.78	46.71	13.15	16.72	7.35	1.02	22.33	11.39	2.32
1000	22.76	46.23	15.05	15.65	7.08	1.00	21.77	10.94	2.35
1100	22.67	45.26	16.72	14.90	6.44	0.98	21.78	10.97	2.38
1200	22.55	44.12	17.69	14.40	5.74	0.97	21.56	10.80	2.32
1300	22.40	43.06	18.13	14.19	5.18	0.96	21.46	10.72	2.38
1400	22.22	42.13	18.21	14.16	4.76	0.96	21.29	10.68	2.34
1500	22.01	41.26	18.07	14.16	4.42	0.96	21.02	10.42	2.34
1600	21.80	40.52	17.81	14.25	4.16	0.96	21.00	10.47	2.38
1700	21.54	39.81	17.36	14.40	3.96	0.96	20.73	10.25	2.37
1800	21.28	39.20	16.95	14.63	3.81	0.96	20.87	10.34	2.37
1900	20.98	38.55	16.38	14.84	3.66	0.97	20.64	10.27	2.37
2000	20.68	38.04	15.81	15.16	3.58	0.97	20.43	10.06	2.38
2200	20.01	36.88	14.81	15.94	3.38	0.98	20.00	9.84	2.39
2400	19.27	35.61	13.80	17.02	3.19	0.99	20.01	9.85	2.50
2600	18.36	34.10	12.83	19.93	2.98	1.01	19.87	9.67	2.53
2800	17.26	33.41	11.20	30.18	3.05	1.05	19.59	9.38	2.64
3000	16.48	34.41	9.22	25.87	3.52	1.10	19.04	8.98	2.67
3200	15.72	34.93	7.95	26.93	3.87	1.15	18.55	8.49	2.85
3400	14.91	35.09	7.02	27.82	4.12	1.19	17.98	8.02	3.02
3600	14.11	35.04	6.26	28.08	4.27	1.23	17.48	7.59	3.16
3800	13.25	35.08	5.55	24.23	4.46	1.27	16.94	7.12	3.37
4000	12.37	34.83	4.94	20.29	4.49	1.30	16.55	6.66	3.62
4200	11.54	34.95	4.41	17.64	4.67	1.33	16.18	6.28	3.83
4400	10.72	35.04	3.94	15.44	4.81	1.36	15.75	5.79	4.03
4600	9.90	34.78	3.60	13.82	4.81	1.37	15.43	5.43	4.37
4800	9.09	34.89	3.30	12.41	5.00	1.37	14.96	4.97	4.52
5000	8.32	34.80	3.07	11.42	5.10	1.37	14.35	4.76	4.78
5100	7.93	34.94	2.97	11.10	5.27	1.37	14.23	4.30	4.90
5200	7.50	34.50	2.80	10.74	5.05	1.38	13.91	4.09	5.10
5300	7.01	34.66	2.68	10.28	5.23	1.38	13.78	3.82	5.31
5400	6.50	34.46	2.57	9.80	5.21	1.37	13.37	3.34	5.54
5500	5.96	34.83	2.54	9.38	5.69	1.36	12.74	3.03	5.65

Typical Performance Data

Definitions:

Input Return Loss = -S11 (dB)

Gain(Power Gain) = S21 (dB)

Reverse Isolation = -S12 (dB)

Output Return Loss = -S22 (dB)

TEST CONDITIONS: Vd = 2.66V, Id = 31.56mA @ Temperature = -45°C

FREQ	Gain	Isolation	Input Return Loss	Output Return Loss	Stability		IP-3 Output	1dB Comp. Output	Noise Figure
					K	Measure			
(MHz)	(dB)	(dB)	(dB)	(dB)			(dBm)	(dBm)	(dB)
200	4.44	38.59	2.12	2.64	3.99	0.75	11.98	1.61	5.52
300	13.70	37.10	2.47	5.37	1.94	1.16	18.73	7.56	3.25
400	18.40	37.85	3.39	8.34	2.04	1.27	21.29	10.20	2.63
500	20.76	39.72	5.02	12.23	2.81	1.25	21.91	11.10	2.50
600	21.86	42.16	7.01	16.46	4.04	1.17	22.37	11.33	2.66
700	22.36	44.56	9.09	19.31	5.58	1.11	22.30	11.28	3.00
800	22.57	46.25	11.18	19.20	6.99	1.06	22.07	11.14	2.35
900	22.62	46.69	13.13	17.68	7.50	1.03	21.96	11.03	2.35
1000	22.59	46.02	15.02	16.52	7.08	1.00	21.41	10.65	2.34
1100	22.49	44.97	16.63	15.70	6.39	0.99	21.43	10.66	2.36
1200	22.36	43.79	17.59	15.18	5.68	0.98	21.24	10.50	2.35
1300	22.20	42.73	18.03	14.99	5.13	0.97	21.16	10.45	2.39
1400	22.01	41.80	18.08	14.94	4.72	0.97	21.02	10.38	2.32
1500	21.81	40.94	17.92	14.94	4.39	0.97	20.70	10.19	2.38
1600	21.58	40.20	17.67	15.06	4.14	0.97	20.67	10.18	2.38
1700	21.32	39.50	17.17	15.23	3.94	0.97	20.43	10.00	2.38
1800	21.06	38.90	16.75	15.46	3.79	0.97	20.58	10.07	2.37
1900	20.76	38.25	16.16	15.69	3.65	0.97	20.37	10.01	2.40
2000	20.45	37.76	15.56	16.05	3.57	0.98	20.19	9.83	2.40
2200	19.78	36.62	14.57	16.87	3.38	0.99	19.74	9.60	2.40
2400	19.04	35.36	13.55	18.03	3.18	1.00	19.72	9.55	2.53
2600	18.13	33.89	12.61	21.15	2.98	1.01	19.56	9.35	2.54
2800	17.05	33.21	11.04	34.52	3.04	1.05	19.29	9.06	2.65
3000	16.27	34.17	9.13	27.12	3.49	1.11	18.75	8.69	2.70
3200	15.52	34.65	7.90	28.00	3.83	1.15	18.29	8.22	2.87
3400	14.71	34.78	6.98	27.58	4.05	1.19	17.70	7.76	3.05
3600	13.92	34.74	6.24	26.20	4.20	1.23	17.20	7.32	3.20
3800	13.07	34.76	5.54	22.61	4.37	1.27	16.67	6.84	3.39
4000	12.19	34.52	4.94	19.11	4.41	1.30	16.27	6.39	3.66
4200	11.37	34.61	4.42	16.70	4.57	1.33	15.89	5.98	3.84
4400	10.55	34.71	3.94	14.70	4.71	1.35	15.48	5.55	4.09
4600	9.74	34.42	3.60	13.20	4.68	1.36	15.16	5.18	4.43
4800	8.94	34.58	3.31	11.88	4.88	1.36	14.69	4.74	4.61
5000	8.17	34.46	3.08	10.96	4.97	1.36	14.07	4.46	4.83
5100	7.78	34.63	2.97	10.67	5.15	1.36	13.97	4.07	4.96
5200	7.35	34.20	2.80	10.32	4.93	1.37	13.63	3.85	5.10
5300	6.87	34.38	2.69	9.89	5.12	1.36	13.52	3.54	5.38
5400	6.35	34.20	2.58	9.45	5.12	1.36	13.09	3.12	5.59
5500	5.82	34.54	2.55	9.06	5.57	1.34	12.47	2.82	5.70

Typical Performance Data

Definitions:

Input Return Loss = -S11 (dB)

Gain(Power Gain) = S21 (dB)

Reverse Isolation = -S12 (dB)

Output Return Loss = -S22 (dB)

TEST CONDITIONS: Vd = 3.30V, Id = 32.19mA @ Temperature = -45°C

FREQ	Gain	Isolation	Input Return Loss	Output Return Loss	Stability		IP-3 Output	1dB Comp. Output	Noise Figure
					K	Measure			
(MHz)	(dB)	(dB)	(dB)	(dB)	K	Measure	(dBm)	(dBm)	(dB)
200	4.66	38.48	2.10	2.60	3.77	0.75	12.62	1.91	5.61
300	14.03	36.80	2.46	5.37	1.76	1.16	19.81	8.24	3.13
400	18.83	37.33	3.32	8.28	1.77	1.28	22.66	11.27	2.59
500	21.30	38.98	4.86	11.87	2.36	1.25	23.45	12.41	2.42
600	22.47	41.21	6.77	14.99	3.28	1.18	23.92	12.47	2.57
700	23.04	43.57	8.79	16.10	4.50	1.11	23.85	12.36	2.95
800	23.29	45.66	10.80	15.37	5.86	1.05	23.53	12.07	2.29
900	23.37	46.92	12.69	14.22	6.89	1.01	23.49	12.06	2.29
1000	23.37	47.05	14.46	13.36	7.08	0.98	22.76	11.38	2.27
1100	23.30	46.38	15.91	12.71	6.64	0.96	22.81	11.52	2.35
1200	23.19	45.34	16.74	12.28	5.97	0.95	22.53	11.25	2.30
1300	23.06	44.27	17.08	12.11	5.37	0.94	22.43	11.15	2.35
1400	22.90	43.31	17.10	12.03	4.90	0.94	22.24	11.18	2.32
1500	22.71	42.38	16.99	12.01	4.51	0.94	21.89	10.79	2.31
1600	22.51	41.58	16.77	12.08	4.21	0.94	21.88	10.90	2.32
1700	22.27	40.83	16.39	12.18	3.98	0.94	21.56	10.61	2.32
1800	22.03	40.18	16.09	12.33	3.81	0.94	21.74	10.78	2.35
1900	21.74	39.49	15.61	12.50	3.64	0.94	21.54	10.69	2.36
2000	21.44	38.94	15.12	12.76	3.54	0.95	21.17	10.40	2.36
2200	20.79	37.69	14.36	13.35	3.33	0.96	20.72	10.15	2.37
2400	20.05	36.30	13.53	14.24	3.10	0.97	20.85	10.36	2.47
2600	19.13	34.65	12.78	16.55	2.88	0.99	20.75	10.25	2.50
2800	18.00	33.91	11.27	22.49	2.97	1.04	20.42	9.90	2.56
3000	17.22	35.05	9.26	21.24	3.47	1.09	19.90	9.54	2.63
3200	16.47	35.68	7.98	21.80	3.87	1.14	19.37	8.99	2.77
3400	15.67	35.90	7.06	23.85	4.14	1.18	18.86	8.60	2.95
3600	14.88	35.88	6.31	27.36	4.32	1.23	18.36	8.14	3.12
3800	14.03	35.91	5.60	30.42	4.52	1.27	17.87	7.65	3.26
4000	13.14	35.60	5.01	26.74	4.55	1.31	17.41	7.17	3.46
4200	12.33	35.72	4.48	22.03	4.75	1.34	17.04	6.76	3.67
4400	11.52	35.79	4.00	18.62	4.90	1.37	16.64	6.31	4.01
4600	10.71	35.46	3.65	16.28	4.87	1.39	16.28	5.94	4.24
4800	9.90	35.56	3.37	14.36	5.08	1.40	15.83	5.49	4.43
5000	9.13	35.43	3.13	13.03	5.17	1.40	15.25	5.18	4.72
5100	8.73	35.57	3.02	12.59	5.35	1.40	15.11	4.79	4.74
5200	8.29	35.15	2.84	12.11	5.13	1.41	14.79	4.56	4.96
5300	7.80	35.23	2.73	11.52	5.28	1.41	14.63	4.31	5.15
5400	7.28	35.02	2.61	10.94	5.27	1.41	14.24	3.85	5.39
5500	6.73	35.47	2.59	10.32	5.81	1.39	13.62	3.44	5.51

Typical Performance Data

Definitions:

Input Return Loss = -S11 (dB)

Gain(Power Gain) = S21 (dB)

Reverse Isolation = -S12 (dB)

Output Return Loss = -S22 (dB)

TEST CONDITIONS: Vd = 2.80V, Id = 32.55mA @ Temperature = +85°C

FREQ	Gain	Isolation	Input Return Loss	Output Return Loss	Stability		IP-3 Output	1dB Comp. Output	Noise Figure
					K	Measure			
(MHz)	(dB)	(dB)	(dB)	(dB)	K	Measure	(dBm)	(dBm)	(dB)
200	3.94	38.74	2.33	2.67	4.74	0.75	11.68	1.46	7.19
300	12.93	37.32	2.77	5.41	2.46	1.13	18.58	7.38	4.58
400	17.51	38.03	3.77	8.52	2.53	1.24	21.29	10.15	3.85
500	19.86	39.77	5.43	12.72	3.32	1.22	22.23	11.18	3.65
600	20.98	41.99	7.54	18.00	4.55	1.16	22.73	11.49	3.70
700	21.50	44.07	9.83	22.02	6.00	1.10	22.57	11.45	3.30
800	21.70	45.32	12.27	21.01	7.11	1.05	22.38	11.31	3.49
900	21.74	45.42	14.76	18.98	7.33	1.02	22.27	11.23	3.47
1000	21.68	44.71	17.21	17.60	6.88	0.99	21.60	10.84	3.42
1100	21.55	43.73	19.47	16.72	6.27	0.98	21.69	10.85	3.52
1200	21.39	42.67	21.14	16.20	5.67	0.97	21.44	10.66	3.51
1300	21.19	41.72	21.94	15.92	5.20	0.97	21.32	10.56	3.56
1400	20.97	40.91	21.96	15.76	4.86	0.97	21.13	10.47	3.48
1500	20.72	40.13	21.48	15.75	4.58	0.97	20.79	10.20	3.46
1600	20.46	39.46	20.99	15.83	4.37	0.97	20.76	10.21	3.53
1700	20.17	38.83	20.40	16.00	4.21	0.97	20.44	9.97	3.53
1800	19.88	38.27	19.91	16.23	4.09	0.97	20.62	9.94	3.52
1900	19.56	37.71	19.31	16.53	3.98	0.97	20.38	9.85	3.59
2000	19.23	37.24	18.80	16.85	3.92	0.97	20.06	9.62	3.58
2200	18.52	36.19	17.46	17.79	3.78	0.98	19.63	9.34	3.61
2400	17.74	35.01	16.00	19.33	3.60	0.99	19.62	9.15	3.74
2600	16.78	33.64	14.47	23.54	3.43	1.01	19.43	8.87	3.80
2800	15.76	33.27	12.19	42.37	3.59	1.04	19.13	8.49	3.88
3000	14.98	34.00	10.08	30.57	4.07	1.09	18.54	8.05	4.00
3200	14.18	34.33	8.60	29.92	4.42	1.13	17.96	7.57	4.13
3400	13.31	34.50	7.41	26.98	4.71	1.17	17.41	7.14	4.42
3600	12.42	34.59	6.43	23.25	4.96	1.22	16.90	6.66	4.64
3800	11.51	34.71	5.62	19.88	5.20	1.26	16.34	6.21	4.89
4000	10.61	34.56	5.00	17.26	5.31	1.29	15.96	5.75	5.18
4200	9.74	34.66	4.46	15.31	5.53	1.31	15.59	5.30	5.45
4400	8.90	34.86	4.01	13.82	5.81	1.33	15.18	4.87	5.76
4600	8.03	34.87	3.66	12.44	5.99	1.34	14.75	4.51	6.16
4800	7.17	35.06	3.37	11.24	6.32	1.34	14.31	4.03	6.39
5000	6.34	35.17	3.13	10.34	6.62	1.34	13.56	3.66	6.70
5100	5.89	35.19	3.04	9.92	6.78	1.33	13.60	3.30	6.90
5200	5.44	35.09	2.94	9.56	6.86	1.33	13.14	2.95	7.07
5300	4.94	35.55	2.88	9.19	7.47	1.32	12.96	2.68	7.31
5400	4.41	35.59	2.82	8.76	7.75	1.31	12.71	2.34	7.61
5500	3.90	35.05	2.74	8.24	7.46	1.29	11.99	2.04	7.85

Typical Performance Data

Definitions:

Input Return Loss = -S11 (dB)

Gain(Power Gain) = S21 (dB)

Reverse Isolation = -S12 (dB)

Output Return Loss = -S22 (dB)

TEST CONDITIONS: Vd = 2.66V, Id = 32.34mA @ Temperature = +85°C

FREQ	Gain	Isolation	Input Return Loss	Output Return Loss	Stability		IP-3 Output	1dB Comp. Output	Noise Figure
					K	Measure			
(MHz)	(dB)	(dB)	(dB)	(dB)	K	Measure	(dBm)	(dBm)	(dB)
200	3.87	38.76	2.33	2.67	4.80	0.75	11.48	1.32	7.09
300	12.84	37.38	2.77	5.41	2.51	1.13	18.29	7.12	4.64
400	17.40	38.12	3.78	8.52	2.60	1.24	21.04	9.70	3.89
500	19.72	39.92	5.47	12.74	3.44	1.22	21.81	10.67	3.63
600	20.83	42.16	7.59	18.16	4.74	1.16	22.27	11.01	3.69
700	21.33	44.21	9.89	22.92	6.23	1.09	22.21	11.00	3.51
800	21.52	45.34	12.34	22.15	7.29	1.05	22.00	10.89	3.51
900	21.55	45.31	14.85	19.89	7.42	1.02	21.88	10.83	3.46
1000	21.48	44.49	17.33	18.37	6.88	1.00	21.28	10.51	3.49
1100	21.35	43.47	19.67	17.42	6.25	0.98	21.36	10.48	3.52
1200	21.19	42.42	21.40	16.87	5.66	0.98	21.12	10.34	3.50
1300	20.98	41.47	22.30	16.57	5.20	0.97	20.95	10.24	3.54
1400	20.76	40.65	22.37	16.41	4.86	0.97	20.79	10.14	3.50
1500	20.51	39.87	21.86	16.40	4.58	0.97	20.50	9.92	3.51
1600	20.24	39.21	21.35	16.50	4.38	0.97	20.47	9.86	3.53
1700	19.95	38.58	20.73	16.68	4.21	0.97	20.20	9.65	3.55
1800	19.65	38.03	20.16	16.92	4.10	0.97	20.30	9.66	3.56
1900	19.33	37.47	19.50	17.25	3.99	0.97	20.09	9.56	3.59
2000	19.00	37.01	18.96	17.59	3.93	0.98	19.79	9.34	3.59
2200	18.28	35.98	17.52	18.59	3.79	0.98	19.37	9.08	3.62
2400	17.50	34.81	15.99	20.22	3.62	0.99	19.34	8.86	3.78
2600	16.55	33.47	14.40	24.67	3.45	1.01	19.12	8.55	3.79
2800	15.54	33.15	12.10	54.73	3.63	1.04	18.78	8.21	3.95
3000	14.76	33.86	10.04	31.17	4.10	1.09	18.24	7.76	4.03
3200	13.96	34.16	8.57	29.57	4.44	1.13	17.72	7.32	4.23
3400	13.09	34.31	7.39	25.77	4.72	1.18	17.17	6.88	4.46
3600	12.20	34.40	6.41	22.17	4.96	1.22	16.66	6.39	4.69
3800	11.29	34.50	5.60	19.04	5.19	1.26	16.10	5.91	4.95
4000	10.39	34.36	4.98	16.61	5.30	1.29	15.75	5.51	5.24
4200	9.52	34.46	4.45	14.78	5.52	1.31	15.37	5.06	5.54
4400	8.67	34.66	4.00	13.37	5.79	1.33	14.94	4.63	5.82
4600	7.81	34.67	3.65	12.05	5.97	1.33	14.54	4.26	6.24
4800	6.95	34.86	3.36	10.91	6.29	1.33	14.08	3.81	6.43
5000	6.12	34.97	3.12	10.05	6.58	1.33	13.33	3.42	6.79
5100	5.68	35.01	3.03	9.65	6.75	1.32	13.40	3.08	6.95
5200	5.22	34.90	2.94	9.30	6.83	1.32	12.92	2.74	7.13
5300	4.73	35.37	2.88	8.95	7.43	1.31	12.75	2.51	7.40
5400	4.20	35.41	2.82	8.54	7.71	1.30	12.50	2.13	7.67
5500	3.68	34.88	2.74	8.04	7.44	1.28	11.77	1.79	7.89

Typical Performance Data

Definitions:

Input Return Loss = -S11 (dB)

Gain(Power Gain) = S21 (dB)

Reverse Isolation = -S12 (dB)

Output Return Loss = -S22 (dB)

TEST CONDITIONS: Vd = 3.30V, Id = 33.24mA @ Temperature = +85°C

FREQ	Gain	Isolation	Input Return Loss	Output Return Loss	Stability		IP-3 Output	1dB Comp. Output	Noise Figure
					K	Measure			
(MHz)	(dB)	(dB)	(dB)	(dB)	K	Measure	(dBm)	(dBm)	(dB)
200	4.10	38.68	2.32	2.65	4.57	0.74	12.20	1.79	7.14
300	13.16	37.16	2.76	5.41	2.33	1.13	19.33	7.97	4.53
400	17.81	37.74	3.73	8.51	2.33	1.25	22.35	11.08	3.84
500	20.22	39.36	5.34	12.63	3.00	1.23	23.18	12.34	3.64
600	21.40	41.50	7.40	17.35	4.06	1.16	23.80	12.49	3.61
700	21.95	43.61	9.65	19.65	5.35	1.09	23.75	12.42	3.47
800	22.18	45.18	12.06	18.38	6.56	1.04	23.37	12.16	3.43
900	22.24	45.75	14.48	16.77	7.11	1.01	23.31	12.13	3.43
1000	22.20	45.38	16.84	15.65	6.92	0.99	22.50	11.52	3.42
1100	22.09	44.57	18.95	14.92	6.41	0.97	22.64	11.60	3.47
1200	21.94	43.59	20.37	14.48	5.84	0.96	22.28	11.35	3.46
1300	21.76	42.65	20.98	14.24	5.35	0.96	22.16	11.24	3.50
1400	21.55	41.83	20.93	14.10	4.99	0.96	22.04	11.19	3.44
1500	21.31	41.05	20.49	14.09	4.69	0.96	21.62	10.84	3.46
1600	21.06	40.37	20.07	14.16	4.47	0.96	21.61	10.86	3.50
1700	20.78	39.73	19.55	14.30	4.29	0.96	21.22	10.58	3.52
1800	20.50	39.16	19.17	14.50	4.16	0.96	21.41	10.64	3.50
1900	20.18	38.60	18.69	14.76	4.05	0.96	21.12	10.50	3.51
2000	19.86	38.13	18.28	15.05	3.99	0.96	20.77	10.23	3.52
2200	19.15	37.08	17.13	15.84	3.84	0.97	20.31	9.91	3.55
2400	18.38	35.87	15.83	17.14	3.67	0.98	20.41	9.87	3.71
2600	17.44	34.38	14.46	20.45	3.45	1.00	20.19	9.59	3.72
2800	16.40	33.74	12.36	27.93	3.54	1.04	19.83	9.17	3.80
3000	15.60	34.46	10.19	26.11	4.01	1.08	19.23	8.71	3.91
3200	14.80	34.88	8.66	26.93	4.39	1.13	18.70	8.24	4.08
3400	13.92	35.10	7.46	28.73	4.72	1.17	18.20	7.82	4.36
3600	13.03	35.23	6.46	27.04	5.00	1.22	17.70	7.36	4.54
3800	12.12	35.36	5.64	22.99	5.26	1.26	17.17	6.89	4.83
4000	11.21	35.19	5.01	19.66	5.38	1.30	16.76	6.47	5.16
4200	10.34	35.30	4.48	17.23	5.62	1.33	16.38	6.01	5.35
4400	9.49	35.53	4.03	15.43	5.94	1.35	15.94	5.56	5.67
4600	8.62	35.49	3.67	13.75	6.11	1.36	15.51	5.18	5.99
4800	7.75	35.68	3.37	12.34	6.45	1.37	15.07	4.70	6.27
5000	6.91	35.78	3.13	11.28	6.75	1.36	14.36	4.39	6.63
5100	6.47	35.80	3.03	10.79	6.92	1.36	14.37	3.98	6.77
5200	6.00	35.67	2.94	10.36	6.99	1.36	13.95	3.69	7.02
5300	5.50	36.12	2.88	9.92	7.60	1.35	13.75	3.39	7.20
5400	4.97	36.10	2.81	9.41	7.82	1.34	13.52	2.99	7.45
5500	4.47	35.53	2.72	8.80	7.49	1.32	12.84	2.73	7.72

Typical Performance Curves

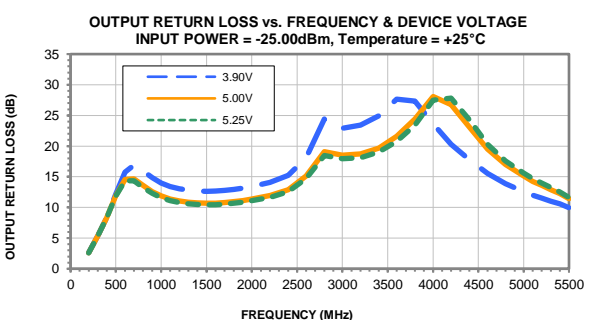
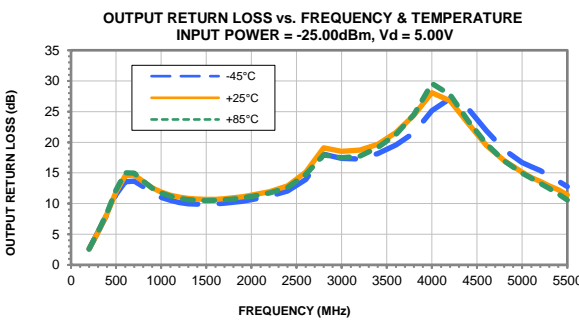
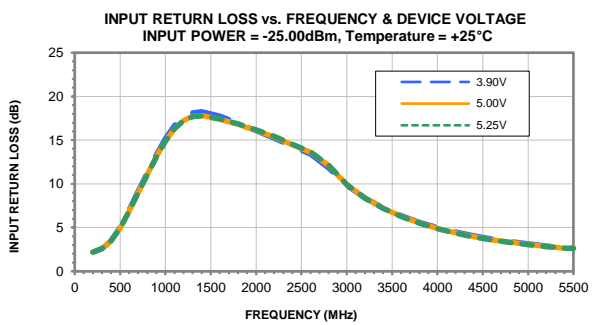
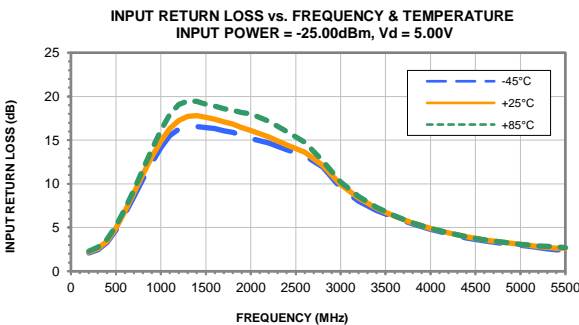
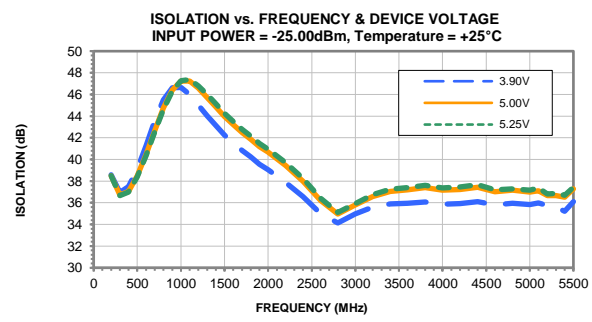
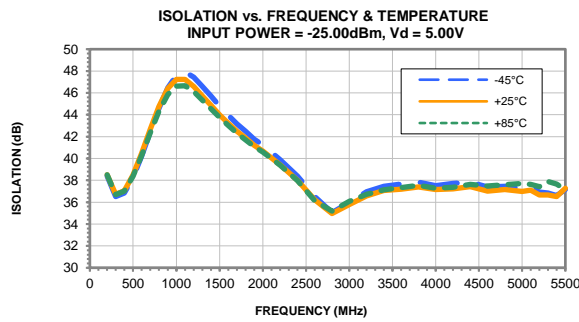
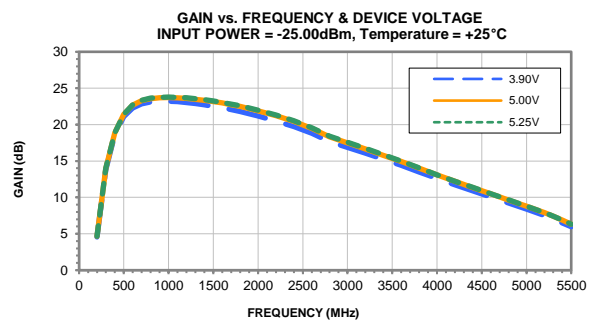
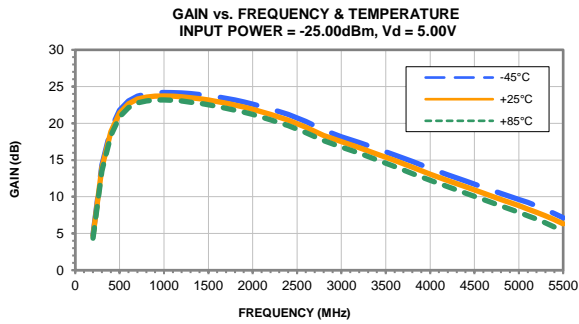

Typical Performance Curves

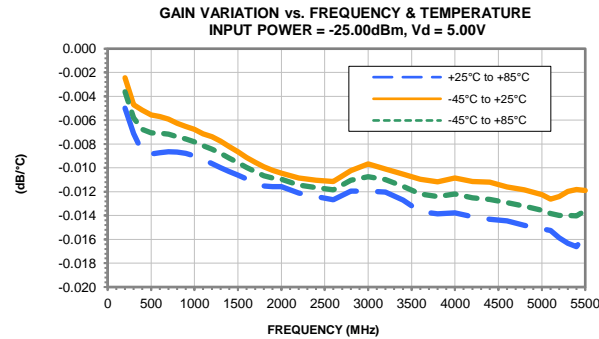
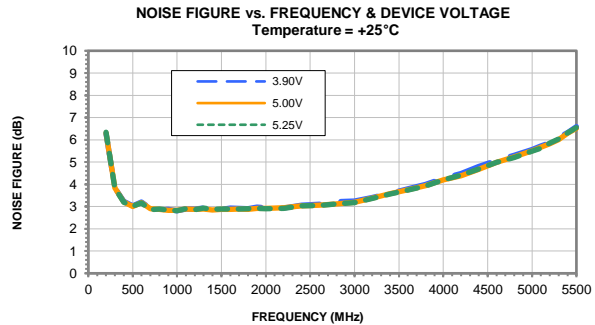
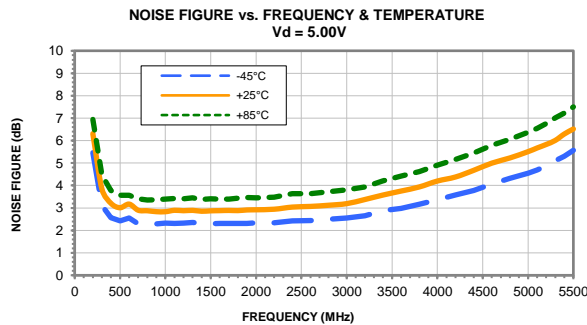
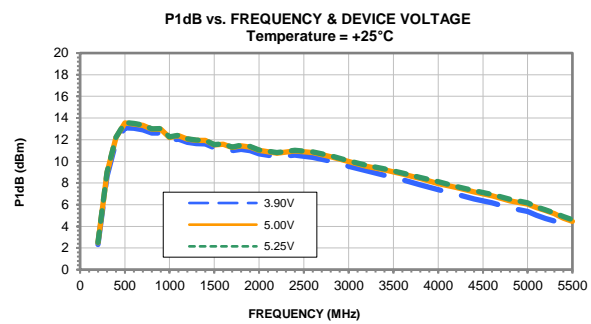
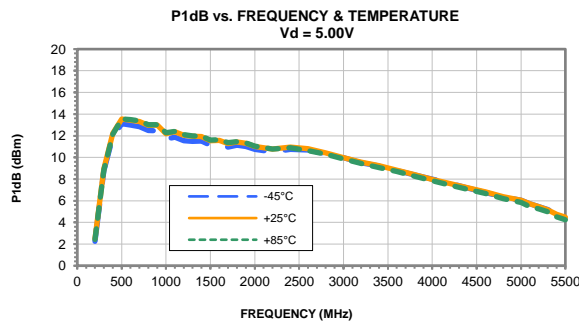
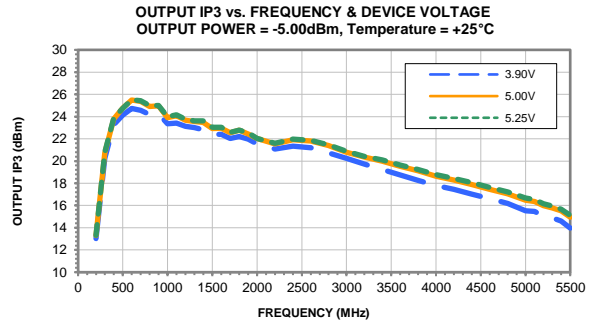
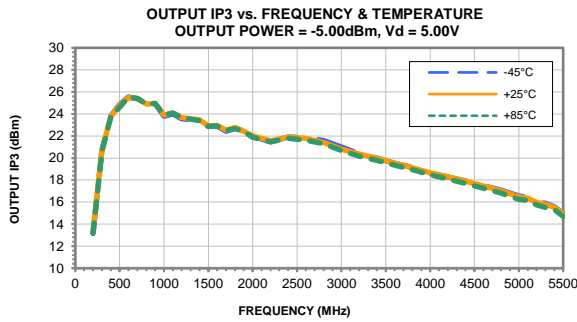

Typical Performance Curves

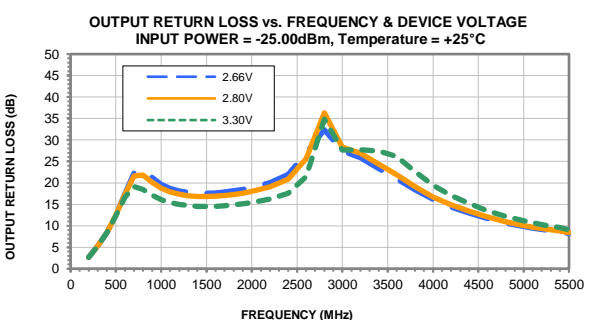
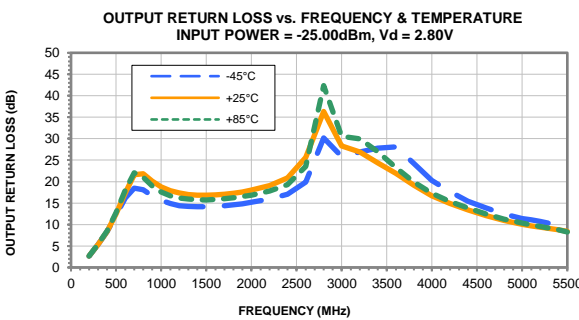
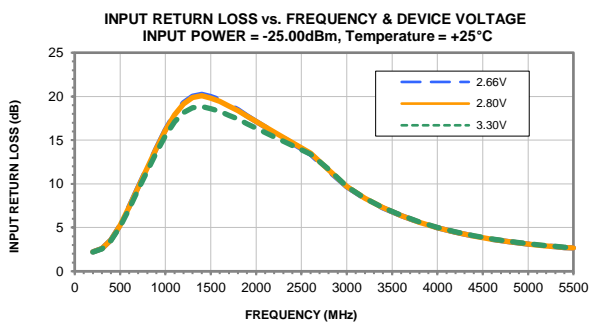
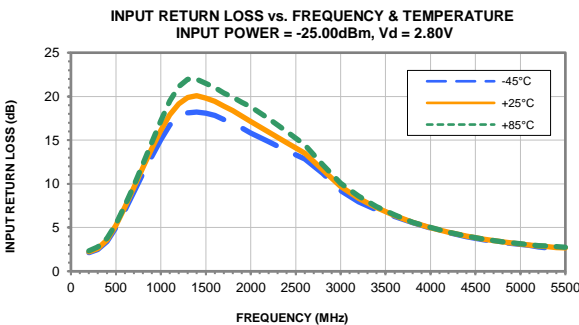
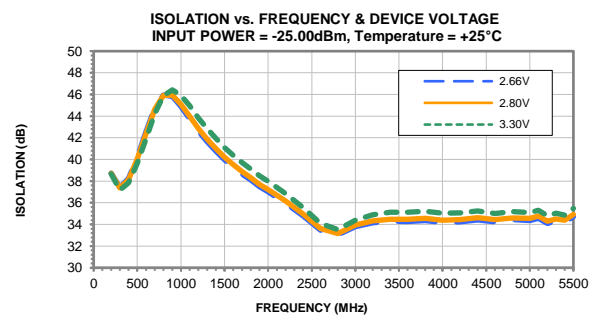
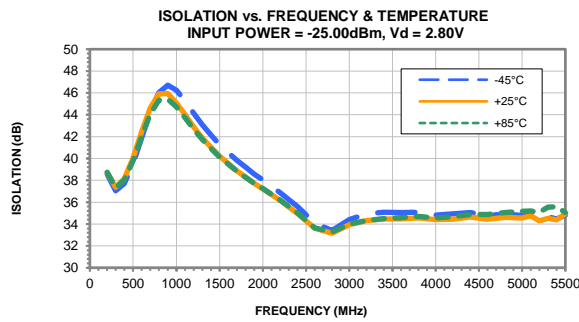
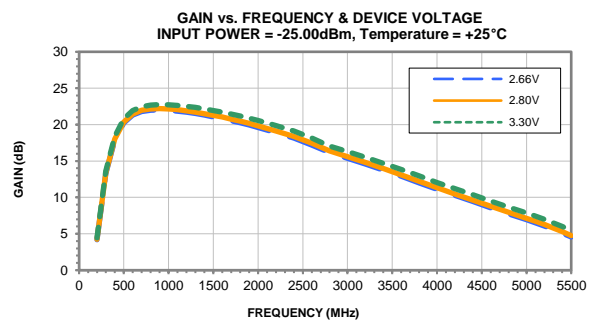
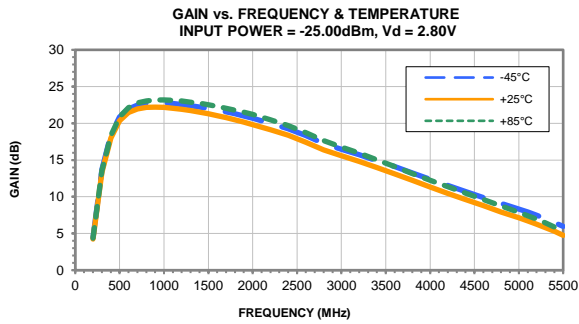

Typical Performance Curves

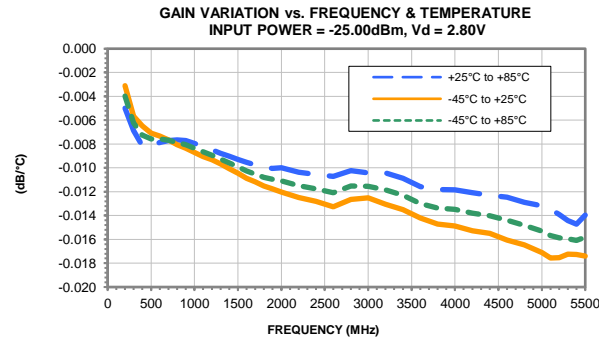
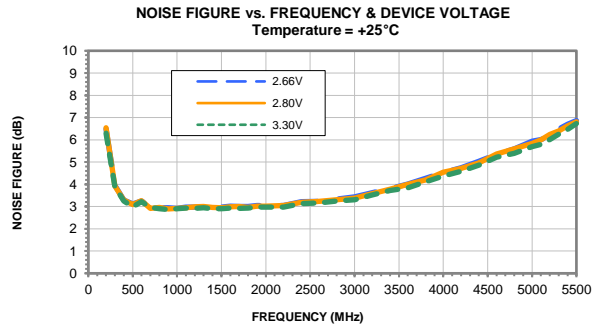
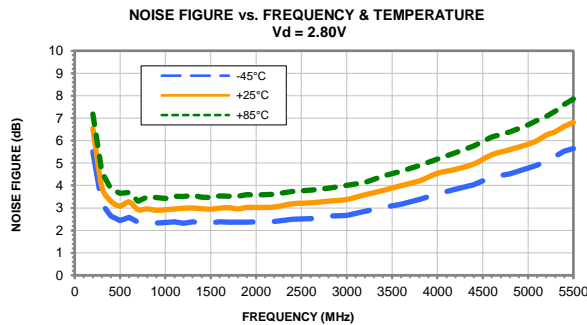
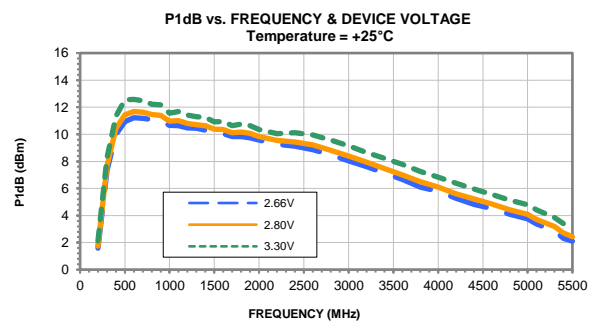
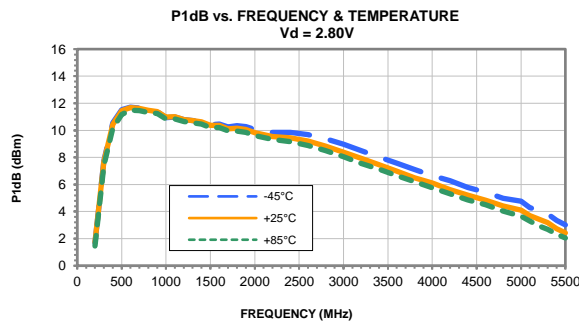
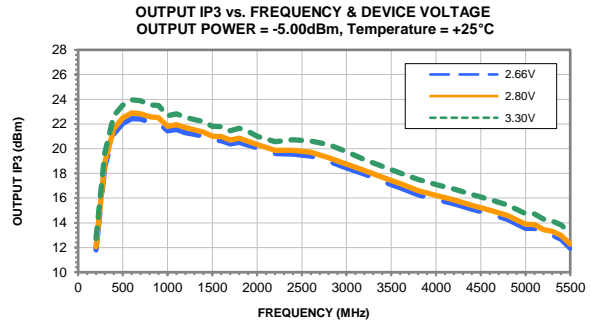
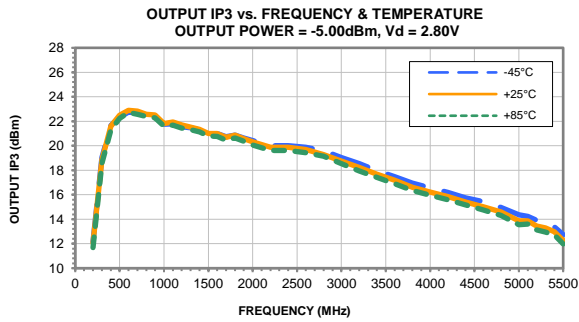

Outline Dimensions

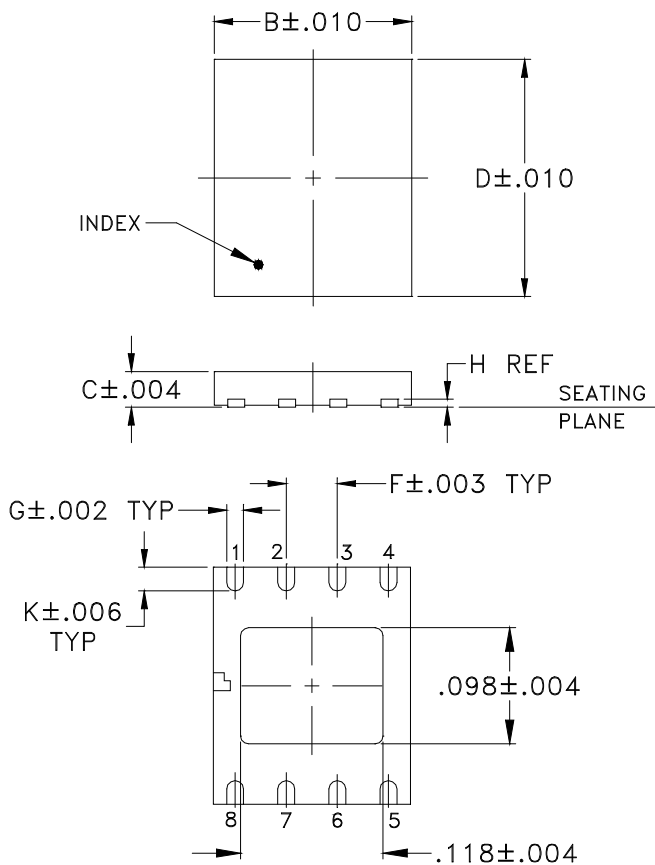

PCB Land Pattern

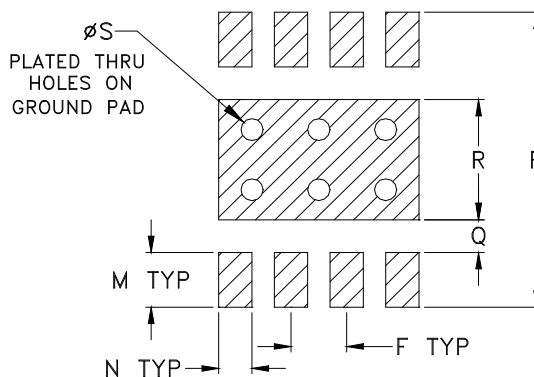

Suggested Layout,
Tolerance to be within $\pm .002$

CASE #	A	B	C	D	E	F	G	H	J	K	L	M	N
DL1020	--	.193 (4.90)	.035 (0.90)	.236 (6.00)	--	.050 (1.27)	.017 (0.42)	.008 (0.20)	--	.024 (0.60)	--	.050 (1.27)	.030 (0.76)

CASE #	P	Q	R	S	T	WT. GRAM
DL1020	.270 (6.86)	.030 (0.76)	.110 (2.79)	.020 (0.51)	-- --	.08

Dimensions are in inches (mm). Tolerances: 2 Pl. $\pm .01$; 3Pl. $\pm .004$

Notes:

- Case material: Plastic.
- Termination finish:
For RoHS Case Styles: Tin-Silver alloy plate over Nickel barrier. All models, (+) suffix.
For RoHS-5 Case Styles: Tin-Lead plate. All models, no (+) suffix.



P.O. Box 350166, Brooklyn, New York 11235-0003 (718) 934-4500 Fax (718) 332-4661 For detailed performance specs & shopping online see Mini-Circuits web site



The Design Engineers Search Engine Provides ACTUAL Data Instantly From MINI-CIRCUITS At: www.minicircuits.com

RF/IF MICROWAVE COMPONENTS

Tape & Reel Packaging TR-F68

DEVICE ORIENTATION IN T&R

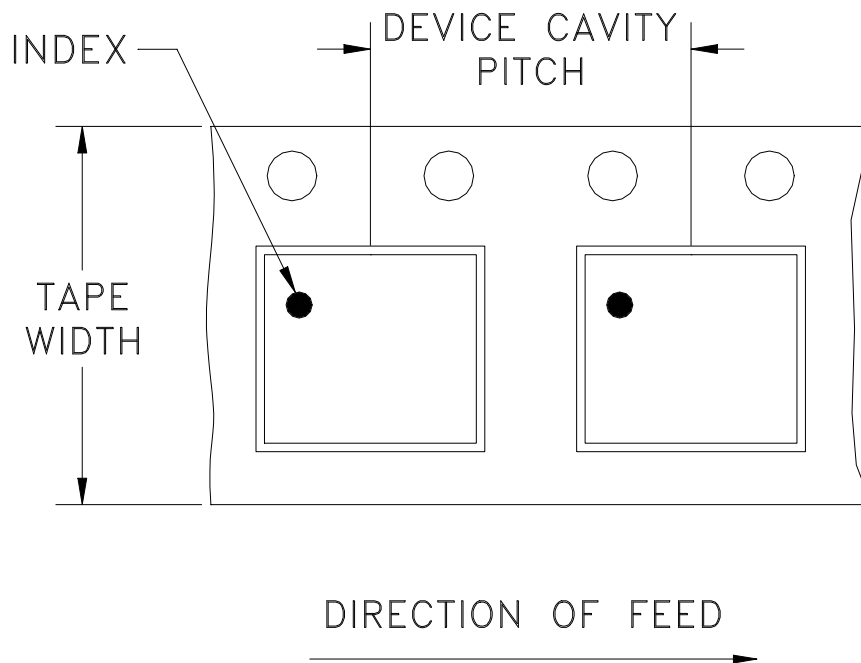

Tape Width, mm	Device Cavity Pitch, mm	Reel Size, inches	Devices per Reel see note	
12	8	7	Small quantity standard	20
				50
				100
				200
				500
		7	Standard	1000
		13	Standard	2000
				3000
				4000

Mini-Circuits carrier tape materials provide protection from ESD (Electro-Static Discharge) during handling and transportation. Tapes are static dissipative and comply with industry standards EIA-481/EIA-541.

Go to: www.minicircuits.com/pages/pdfs/tape.pdf



INTERNET <http://www.minicircuits.com>

P.O. Box 350166, Brooklyn, New York 11235-0003 (718) 934-4500 Fax (718) 332-4661

Distribution Centers NORTH AMERICA 800-654-7949 • 417-335-5935 • Fax 417-335-5945 • EUROPE 44-1252-832600 • Fax 44-1252-837010

Mini-Circuits ISO 9001 & ISO 14001 Certified

THIRD ANGLE PROJECTION

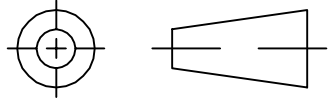

REVISIONS

REV	ECN No.	DESCRIPTION	DATE	DR	AUTH
OR	M82272	NEW RELEASE	08/05/02	GF	DJ
A	M84246	UPDATED DRAWING	11/21/02	AV	LC
B	M91639	REMOVED NOTE 2, UPDATED DIMENSIONS	04/14/04	AV	DJ
C	M102713	UPDATED DWG. & ADDED "...WITH SMOBC"	01/25/08	MMG	DJ

SUGGESTED MOUNTING CONFIGURATION FOR XX211 CASE STYLE, "hj" PIN CONNECTION

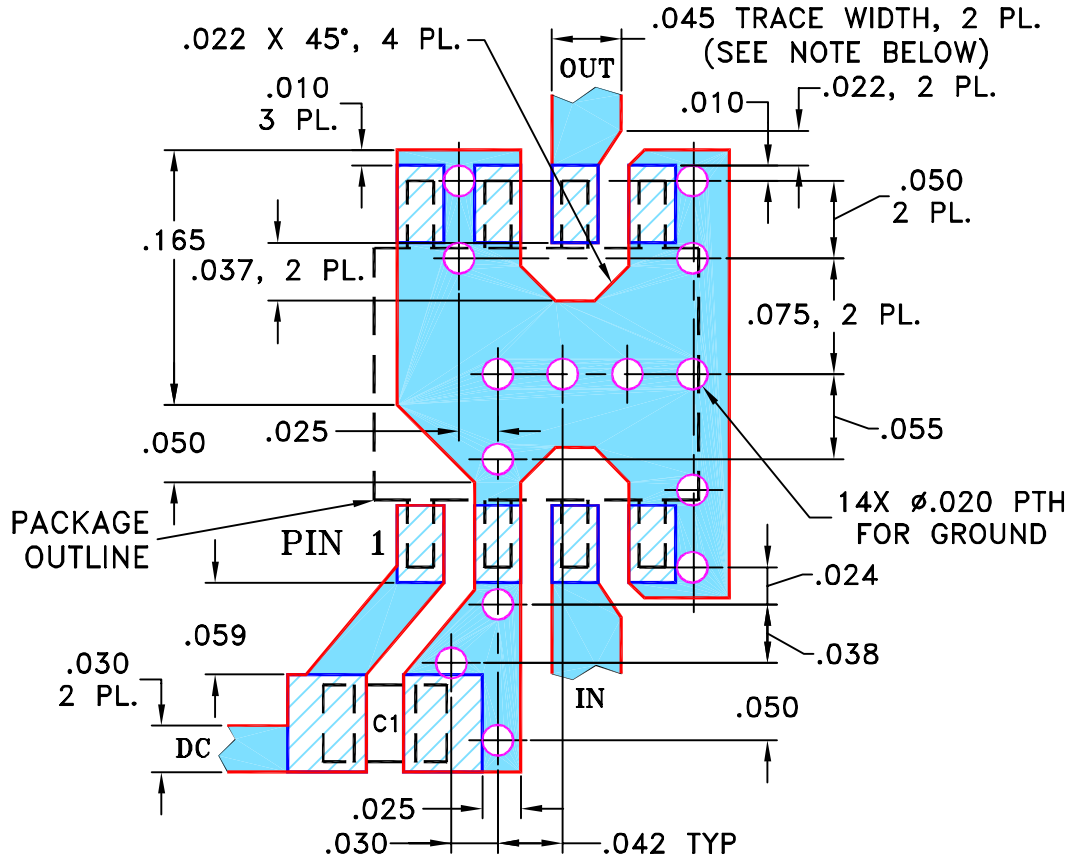

CAPACITOR C1: .01 uF, 0805 SIZE

- NOTES: 1. TRACE WIDTH IS SHOWN FOR ROGERS RO4350B WITH DIELECTRIC THICKNESS $.020 \pm .0015$; COPPER: 1/2 OZ. EACH SIDE. FOR OTHER MATERIALS TRACE WIDTH MAY NEED TO BE MODIFIED.
2. BOTTOM SIDE OF THE PCB IS CONTINUOUS GROUND PLANE.



DENOTES PCB COPPER LAYOUT WITH SMOBC (SOLDER MASK OVER BARE COPPER)



DENOTES COPPER LAND PATTERN FREE OF SOLDER MASK

UNLESS OTHERWISE SPECIFIED	INITIALS	DATE
DIMENSIONS ARE IN INCHES	DRAWN GF	07/19/02
TOLERANCES ON:	CHECKED LC	08/01/02
2 PL DECIMALS \pm	APPROVED DJ	08/05/02
3 PL DECIMALS $\pm .005$		
ANGLES \pm		
FRACTIONS \pm		



Mini-Circuits®

13 Neptune Avenue
Brooklyn NY 11235

PL, hj, XX211, VNA, TB-01

SIZE	CODE IDENT	DRAWING NO:	REV:
A	15542	98-PL-077	C
FILE:	98PL077	SCALE:	8:1
		SHEET:	1 OF 1

THIS DOCUMENT AND ITS CONTENTS ARE THE PROPERTY OF MINI-CIRCUITS. EXCEPT FOR USE EXPRESSLY GRANTED, IN WRITING, TO ITS VENDORS, VENDEE AND THE UNITED STATES GOVERNMENT, MINI-CIRCUITS RESERVES ALL PROPRIETARY DESIGN, USE, MANUFACTURING AND REPRODUCTION RIGHTS THERETO. THESE CONTENTS SHALL NOT BE USED, DUPLICATED OR DISCLOSED TO ANY OUTSIDE PARTY, IN WHOLE OR IN PART, WITHOUT WRITTEN PERMISSION OF MINI-CIRCUITS.

Evaluation Board and Circuit

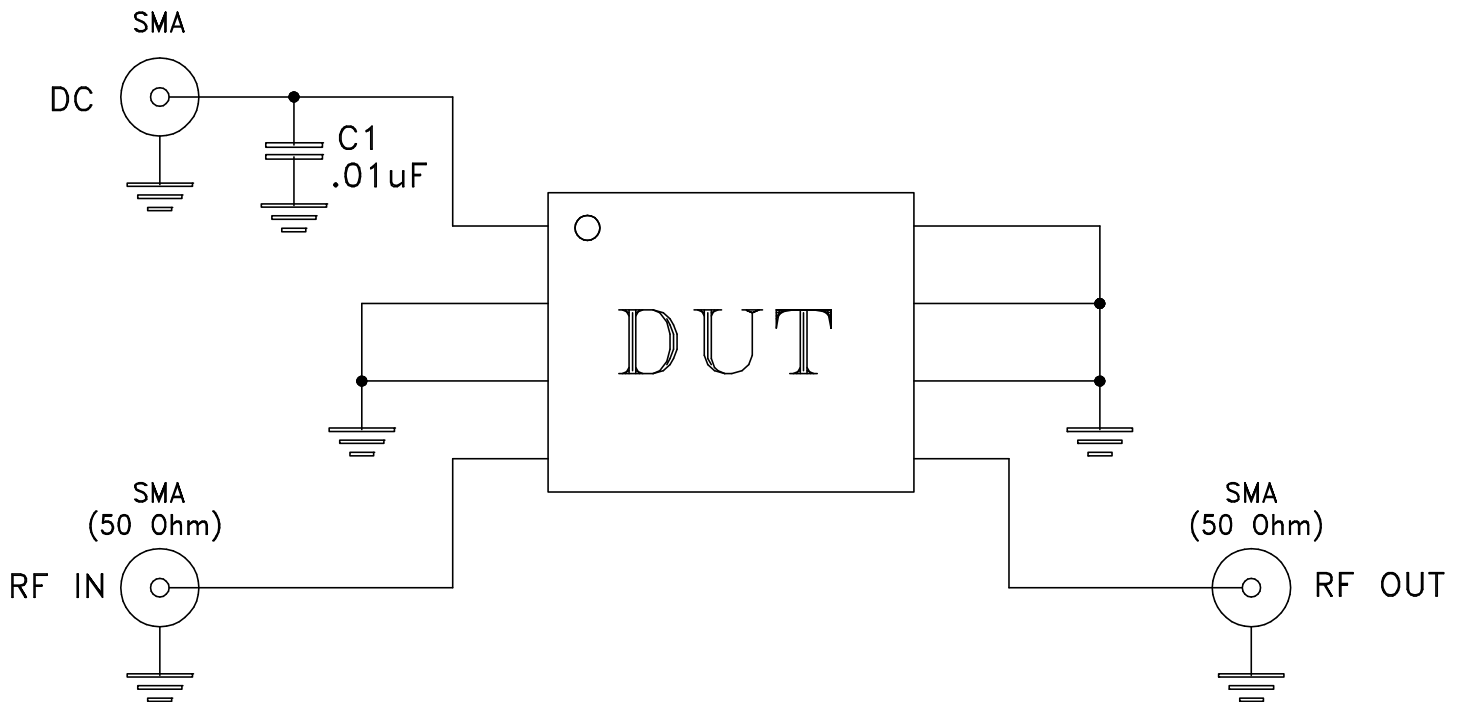
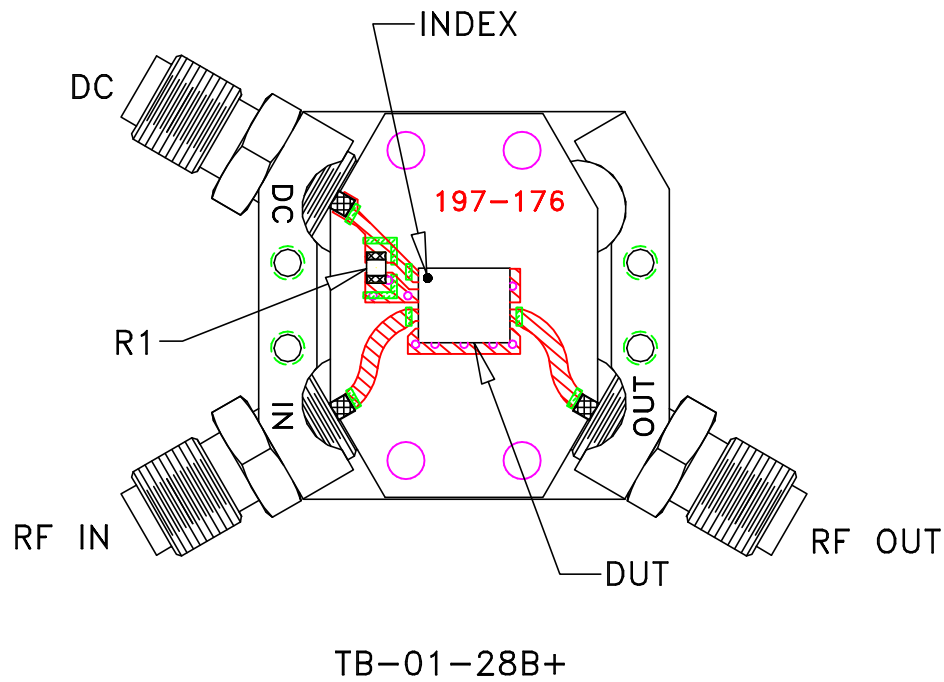

Schematic Diagram

Notes:

1. SMA Female connectors.
2. PCB Material: Rogers R04350 or equivalent,
Dielectric Constant=3.5, Thickness=.020 inch.

 **Mini-Circuits®**

All Mini-Circuits products are manufactured under exacting quality assurance and control standards, and are capable of meeting published specifications after being subjected to any or all of the following physical and environmental test.

Specification	Test/Inspection Condition	Reference/Spec
Operating Temperature	-40° to 85°C Ambient Environment	Individual Model Data Sheet
Storage Temperature	-55° to 100° C or -65° to 150° Ambient Environment	Individual Model Data Sheet
Thermal Shock	-55° to 100°C, 100 cycles	MIL-STD-202, Method 107, Condition A-3, except +100°C
Mechanical Shock	1.5Kg, 0.5 ms, 5 shock pulses, Y1 direction only	MIL-STD-883, Method 2002, Condition B, except Y1 direction only
Vibration (Variable Frequency)	50g peak	MIL-STD-883, Method 2007, Condition B
Autoclave	15 psig, 100% RH, 121°C, 96 hours	JESD22-A102, Condition C
HAST	130°C, 85% RH, 96 hours	JESD22-A110
Solderability	10X Magnification	J-STD-002, Para 4.2.5, Test S, 95% Coverage
Solder Reflow Heat	Sn-Pb Eutetic Process: 240°C peak Pb-Free Process: 260°C peak	J-STD-020, Table 4-1, 4-2 and 5-2; Figure 5-1
Moisture Sensitivity: Level 1	Bake at 125°C for 24 hours Soak at 85°C/85% RH for 168 hours, Reflow 3 cycles at 260°C peak	J-STD-020
Marking Resistance to Solvents	Isopropyl alcohol + mineral spirits at 25°C; terpene defluxer at 25°C; distilled water + proylene glycol monomethyl ether +	MIL-STD-202, Method 215



All Mini-Circuits products are manufactured under exacting quality assurance and control standards, and are capable of meeting published specifications after being subjected to any or all of the following physical and environmental test.

Specification	Test/Inspection Condition	Reference/Spec
---------------	---------------------------	----------------

monoethanolamine at 63°C to 70°C