

# High IP3 Frequency Mixer

Level 17 (LO Power +17 dBm) 100 to 1370 MHz

## SYM-14H+



Generic photo used for illustration purposes only

CASE STYLE: TTT167

**+RoHS Compliant**

The +Suffix identifies RoHS Compliance. See our web site for RoHS Compliance methodologies and qualifications

Available Tape and Reel at no extra cost	
Reel Size	Devices/Reel
7"	10, 20, 50, 100, 200
13"	500

### Maximum Ratings

Operating Temperature	-40°C to 85°C
Storage Temperature	-55°C to 100°C
RF Power	200mW
IF Current	40mA
Permanent damage may occur if any of these limits are exceeded.	

### Pin Connections

LO	2
RF	1
IF	3
GROUND	4,5,6

### Outline Drawing

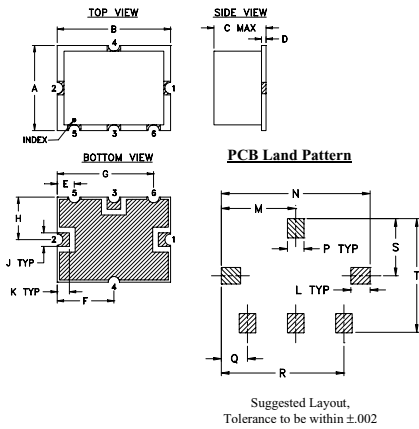

### Outline Dimensions (inch/mm)

A	B	C	D	E	F	G	H	J	K
.38	.50	.23	.020	.075	.250	.425	.187	.050	.050
9.65	12.70	5.84	0.51	1.91	6.35	10.80	4.75	1.27	1.27
L	M	N	P	Q	R	S	T	wt.	
.070	.270	.540	.060	.095	.445	.208	.415	grams	
1.78	6.86	13.72	1.52	2.41	11.30	5.28	10.54	0.8	

### Demo Board MCL P/N: TB-12 Suggested PCB Layout (PL-079)

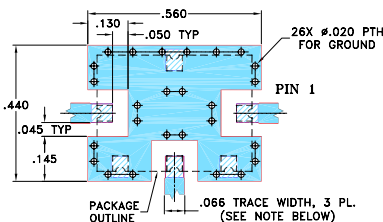

#### NOTE:

- TRACE WIDTH IS SHOWN FOR ROGERS RO4350B WITH DIELECTRIC THICKNESS .030" ± .002"; COPPER: 1/2 OZ. EACH SIDE. FOR OTHER MATERIALS TRACE WIDTH MAY NEED TO BE MODIFIED.
- THE USE OF SOLDER MASK OVER THE GROUND AREA UNDER THE UNIT AS SHOWN IS RECOMMENDED TO PREVENT POTENTIAL SHORTING. IF USER CHOOSES TO EXPOSE METAL UNDER THE ENTIRE UNIT GROUND PAD FOR IMPROVED GROUNDING, IT IS RECOMMENDED A SOLDER MASK DAM BE APPLIED AROUND EACH GROUND PAD TO ENSURE FILLET AND CONNECTION AT GROUND PADS.
- BOTTOM SIDE OF THE PCB IS CONTINUOUS GROUND PLANE.
  - DENOTES PCB COPPER LAYOUT WITH SMOBC (SOLDER MASK OVER BARE COPPER). SEE NOTE 2.
  - DENOTES COPPER LAND PATTERN FREE OF SOLDER MASK

#### Notes

- Performance and quality attributes and conditions not expressly stated in this specification document are intended to be excluded and do not form a part of this specification document.
- Electrical specifications and performance data contained in this specification document are based on Mini-Circuit's applicable established test performance criteria and measurement instructions.
- The parts covered by this specification document are subject to Mini-Circuits standard limited warranty and terms and conditions (collectively, "Standard Terms"); Purchasers of this part are entitled to the rights and benefits contained therein. For a full statement of the Standard Terms and the exclusive rights and remedies thereunder, please visit Mini-Circuits' website at [www.minicircuits.com/MCLStore/terms.jsp](http://www.minicircuits.com/MCLStore/terms.jsp)

### Features

- wide bandwidth, 100 to 1370 MHz
- low conversion loss, 6.5 dB typ.
- high IP3, 30 dBm typ.
- excellent match LO VSWR, 1.25:1 typ.; RF VSWR, 1.6:1 typ.
- good L-R isolation, 36 dB typ.

### Applications

- cellular
- UHF TV
- ISM

### Electrical Specifications

FREQUENCY (MHz)	CONVERSION LOSS (dB)	LO-RF ISOLATION (dB)		LO-IF ISOLATION (dB)		IP3 at center band (dBm)
		Typ.	Min.	Typ.	Min.	
100-1370	6.5	36	28	30	24	30

1 dB COMP: +14 dBm typ.  
m=mid band ( $2f_L$  to  $f_U/2$ )

### Typical Performance Data

Frequency (MHz)		Conversion Loss (dB)	Isolation L-R (dB)	Isolation L-I (dB)	VSWR RF Port (:1)	VSWR LO Port (:1)
RF	LO	LO +17dBm	LO +17dBm	LO +17dBm	LO +17dBm	LO +17dBm
100.00	130.00	5.64	40.30	44.40	1.21	1.64
190.71	220.71	5.86	38.80	40.50	1.33	1.63
200.00	230.00	5.82	38.70	39.70	1.32	1.66
281.42	311.42	5.94	37.70	36.90	1.39	1.62
372.14	402.14	5.98	37.30	34.70	1.51	1.52
400.00	430.00	5.98	36.80	33.90	1.51	1.53
462.85	492.85	6.05	36.50	33.60	1.59	1.44
553.57	583.57	6.01	36.20	31.50	1.76	1.34
600.00	630.00	6.02	36.50	31.30	1.85	1.29
644.28	674.28	6.15	36.20	29.80	1.89	1.28
735.00	765.00	6.43	36.60	29.60	1.96	1.23
825.71	855.71	6.45	36.00	29.70	1.99	1.18
916.42	946.42	6.66	36.00	30.50	2.08	1.12
1000.00	1030.00	6.23	36.50	30.60	2.06	1.09
1007.14	1037.14	6.38	36.60	30.70	2.03	1.08
1097.85	1127.85	6.36	40.50	31.20	2.06	1.07
1188.57	1218.57	6.52	43.10	32.50	1.94	1.08
1279.28	1309.28	6.89	41.80	34.80	2.06	1.12
1340.00	1370.00	7.18	42.30	38.20	2.06	1.18
1370.00	1400.00	7.34	42.10	39.80	2.10	1.18

### Electrical Schematic

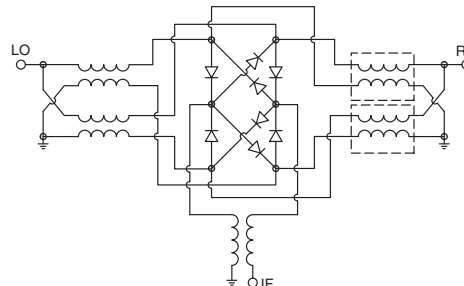

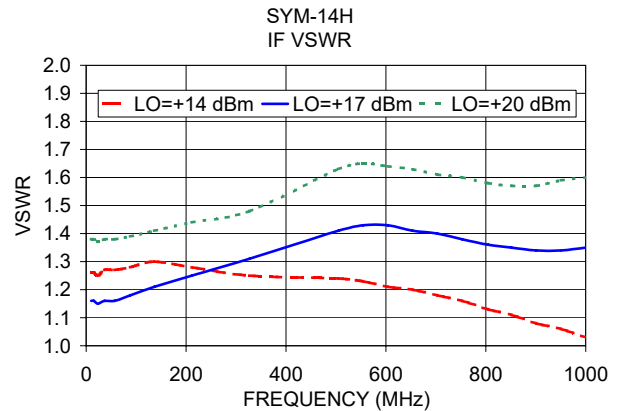
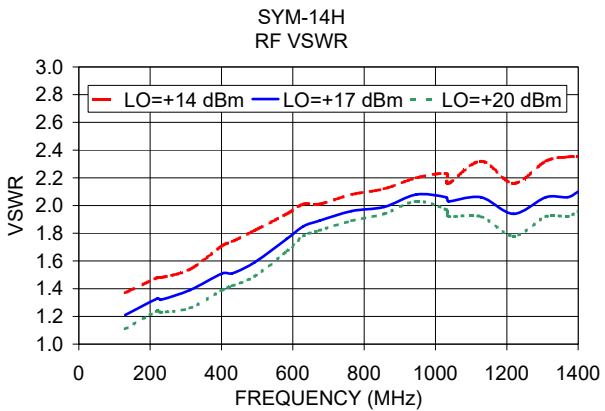
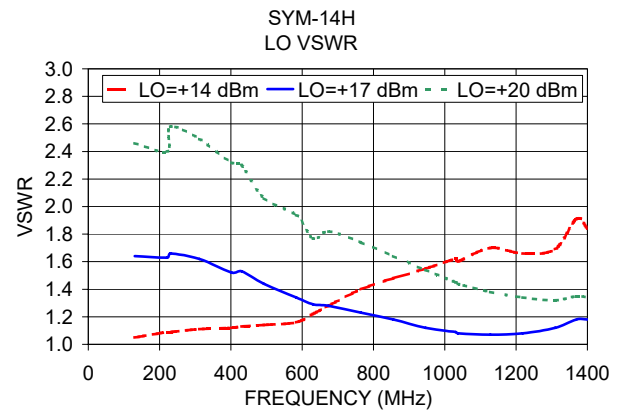
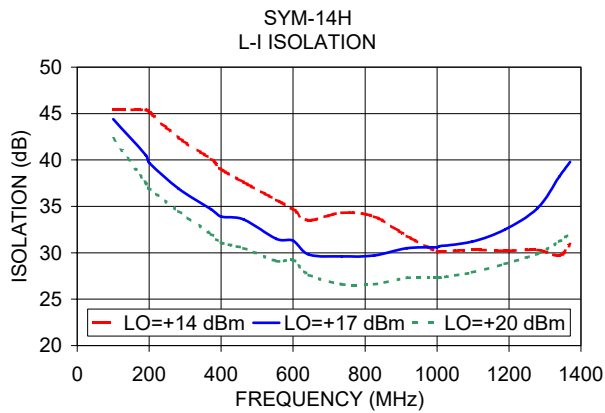
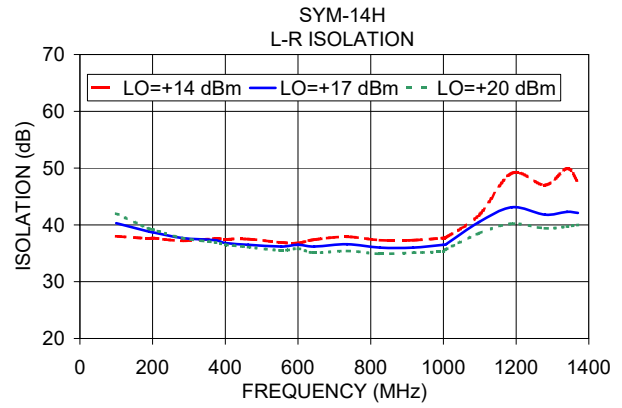
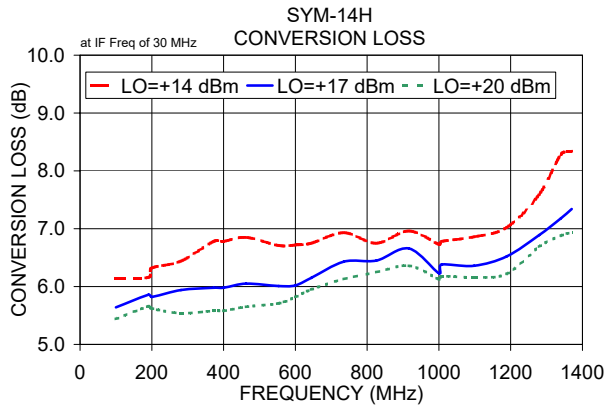

**Notes**

- A. Performance and quality attributes and conditions not expressly stated in this specification document are intended to be excluded and do not form a part of this specification document.
- B. Electrical specifications and performance data contained in this specification document are based on Mini-Circuit's applicable established test performance criteria and measurement instructions.
- C. The parts covered by this specification document are subject to Mini-Circuits standard limited warranty and terms and conditions (collectively, "Standard Terms"); Purchasers of this part are entitled to the rights and benefits contained therein. For a full statement of the Standard Terms and the exclusive rights and remedies thereunder, please visit Mini-Circuits' website at [www.minicircuits.com/MCLStore/terms.jsp](http://www.minicircuits.com/MCLStore/terms.jsp)



# Frequency Mixer

# SYM-14H+

## Typical Performance Data

RF (IN) (MHz)	LO (MHz)	CONVERSION LOSS IF FIXED @IF(OUT)=30MHz (dB)			RF (IN) (MHz)	LO (MHz)	IP3 INPUT (dBm)			RF (IN) (MHz)	LO (MHz)	COMPRESSION @RF IN=+14dBm (dB)		
		@LO (dBm)					@LO (dBm)					@LO (dBm)		
		+14	+17	+20			+14	+17	+20			+14	+17	+20
10.1	40.1	5.80	5.34	5.06	10.1	40.1	29.82	31.82	29.22	10.1	40.1	1.21	0.79	0.61
70.8	100.8	5.84	5.39	5.20	70.8	100.8	24.30	25.10	25.28	70.8	100.8	1.14	0.79	0.63
131.5	161.5	5.98	5.51	5.30	131.5	161.5	24.05	24.88	29.14	131.5	161.5	1.13	0.77	0.59
192.1	222.1	6.17	5.66	5.40	192.1	222.1	24.35	28.95	30.70	192.1	222.1	1.05	0.72	0.61
252.8	282.8	6.26	5.74	5.42	252.8	282.8	25.86	27.85	27.58	252.8	282.8	1.07	0.77	0.65
313.5	343.5	6.46	5.80	5.44	313.5	343.5	24.60	31.05	28.67	313.5	343.5	1.05	0.84	0.73
374.2	404.2	6.70	5.90	5.51	374.2	404.2	23.64	28.16	27.14	374.2	404.2	1.00	0.85	0.72
434.8	464.8	6.68	5.85	5.54	434.8	464.8	24.61	26.17	29.22	434.8	464.8	1.01	0.89	0.70
515.7	545.7	6.71	5.90	5.61	515.7	545.7	29.38	25.62	32.11	515.7	545.7	1.23	0.96	0.73
576.4	606.4	6.57	5.93	5.68	576.4	606.4	26.32	30.92	31.91	576.4	606.4	1.23	0.81	0.61
657.3	687.3	6.62	6.05	5.84	657.3	687.3	25.74	31.49	33.16	657.3	687.3	1.17	0.70	0.51
718.0	748.0	6.65	6.20	6.02	718.0	748.0	27.36	35.36	32.42	718.0	748.0	0.94	0.58	0.46
798.9	828.9	6.89	6.38	6.18	798.9	828.9	30.02	30.82	29.89	798.9	828.9	0.82	0.41	0.35
859.6	889.6	6.86	6.41	6.22	859.6	889.6	29.93	30.14	28.15	859.6	889.6	0.65	0.34	0.31
940.5	970.5	7.08	6.49	6.26	940.5	970.5	26.87	32.36	27.64	940.5	970.5	0.64	0.28	0.24
1001.2	1031.2	7.07	6.54	6.33	1001.2	1031.2	33.61	28.45	28.40	1001.2	1031.2	0.60	0.29	0.27
1082.1	1112.1	7.53	6.73	6.50	1082.1	1112.1	24.68	29.51	28.38	1082.1	1112.1	0.59	0.32	0.27
1142.7	1172.7	7.64	6.89	6.65	1142.7	1172.7	24.82	32.19	29.48	1142.7	1172.7	0.53	0.32	0.27
1223.6	1253.6	8.13	7.15	6.86	1223.6	1253.6	21.55	27.84	29.86	1223.6	1253.6	0.41	0.38	0.33
1284.3	1314.3	8.56	7.43	7.03	1284.3	1314.3	21.77	26.22	32.22	1284.3	1314.3	0.33	0.36	0.37
1365.2	1395.2	9.25	7.91	7.36	1365.2	1395.2	21.57	26.74	32.11	1365.2	1395.2	0.20	0.32	0.40
1425.9	1455.9	9.78	8.27	7.64	1425.9	1455.9	22.03	27.64	34.82	1425.9	1455.9	0.07	0.28	0.37
1506.8	1536.8	10.28	8.65	7.90	1506.8	1536.8	22.90	30.90	34.57	1506.8	1536.8	-0.05	0.26	0.38
1567.5	1597.5	10.75	8.89	8.13	1567.5	1597.5	23.59	37.87	32.05	1567.5	1597.5	-0.16	0.23	0.33
1648.4	1678.4	10.87	9.14	8.42	1648.4	1678.4	26.80	30.67	34.18	1648.4	1678.4	-0.10	0.24	0.29
1709.0	1739.0	11.23	9.30	8.53	1709.0	1739.0	26.94	29.55	30.78	1709.0	1739.0	-0.10	0.29	0.32
1789.9	1819.9	10.82	9.26	8.54	1789.9	1819.9	27.17	27.73	27.24	1789.9	1819.9	0.27	0.41	0.42
1850.6	1880.6	10.74	9.20	8.48	1850.6	1880.6	28.83	25.61	26.42	1850.6	1880.6	0.43	0.51	0.51
1931.5	1961.5	10.03	8.83	8.24	1931.5	1961.5	24.09	25.42	25.93	1931.5	1961.5	0.94	0.82	0.70
1992.2	2022.2	9.94	8.75	8.18	1992.2	2022.2	21.87	24.63	26.32	1992.2	2022.2	1.28	1.05	0.89
2073.1	2103.1	9.56	8.63	8.18	2073.1	2103.1	20.34	23.80	24.88	2073.1	2103.1	1.79	1.33	1.03
2133.8	2163.8	9.59	8.72	8.28	2133.8	2163.8	20.75	23.77	25.18	2133.8	2163.8	1.96	1.33	1.06
2214.7	2244.7	9.58	8.74	8.25	2214.7	2244.7	20.56	22.68	23.60	2214.7	2244.7	2.15	1.51	1.20
2275.4	2305.4	9.58	8.68	8.17	2275.4	2305.4	20.00	21.76	22.48	2275.4	2305.4	2.47	1.77	1.40
2356.3	2386.3	9.64	8.65	8.12	2356.3	2386.3	18.41	20.99	21.92	2356.3	2386.3	2.86	2.06	1.59
2416.9	2446.9	9.84	8.82	8.22	2416.9	2446.9	17.66	21.04	21.56	2416.9	2446.9	3.12	2.19	1.64
2497.8	2527.8	10.49	9.19	8.53	2497.8	2527.8	16.84	20.27	21.23	2497.8	2527.8	3.21	2.25	1.58
2558.5	2588.5	10.91	9.49	8.73	2558.5	2588.5	17.28	20.23	20.58	2558.5	2588.5	3.09	2.24	1.54
2639.4	2669.4	11.83	10.01	9.12	2639.4	2669.4	19.43	19.66	20.78	2639.4	2669.4	2.80	2.21	1.43
2700.1	2730.1	12.42	10.45	9.44	2700.1	2730.1	25.05	19.89	20.92	2700.1	2730.1	2.43	2.21	1.45



# Frequency Mixer

# SYM-14H+

## Typical Performance Data

IF (OUT) (MHz)	LO (MHz)	CONVERSION LOSS VS. IF FREQUENCY @RF(IN)=685.1MHz (dB)	IF (OUT) (MHz)	LO (MHz)	CONVERSION LOSS VS. IF FREQUENCY @RF(IN)=100.1MHz (dB)	IF (OUT) (MHz)	LO (MHz)	CONVERSION LOSS VS. IF FREQUENCY @RF(IN)=1370.1MHz (dB)
		@LO (dBm)			@LO (dBm)			@LO (dBm)
		+17			+17			+17
485.0	200.1	6.78	10.0	110.1	5.40	1000.0	370.1	8.84
472.8	212.3	6.75	30.2	130.3	5.47	979.8	390.3	8.78
460.6	224.5	6.68	50.4	150.5	5.48	959.6	410.5	8.84
448.5	236.6	6.69	70.6	170.7	5.55	939.4	430.7	8.83
436.3	248.8	6.79	90.8	190.9	5.48	919.2	450.9	8.61
424.1	261.0	6.83	111.0	211.1	5.57	899.0	471.1	8.67
411.9	273.2	6.75	131.2	231.3	5.56	878.8	491.3	8.64
399.7	285.4	6.71	151.4	251.5	5.52	858.6	511.5	8.41
387.6	297.5	6.74	171.6	271.7	5.54	838.4	531.7	8.46
375.4	309.7	6.80	191.8	291.9	5.60	818.2	551.9	8.32
363.2	321.9	6.83	212.0	312.1	5.58	798.0	572.1	8.28
351.0	334.1	6.77	232.2	332.3	5.53	777.8	592.3	8.30
338.8	346.3	6.64	252.4	352.5	5.58	757.6	612.5	8.20
326.7	358.4	6.67	272.7	372.8	5.49	737.3	632.8	8.15
314.5	370.6	6.68	292.9	393.0	5.50	717.1	653.0	8.11
302.3	382.8	6.77	313.1	413.2	5.54	696.9	673.2	8.07
290.1	395.0	6.75	333.3	433.4	5.46	676.7	693.4	8.02
277.9	407.2	6.59	353.5	453.6	5.41	656.5	713.6	8.00
265.8	419.3	6.54	373.7	473.8	5.47	636.3	733.8	7.95
253.6	431.5	6.69	393.9	494.0	5.38	616.1	754.0	7.86
241.4	443.7	6.67	434.3	534.4	5.36	575.7	794.4	7.85
229.2	455.9	6.61	454.5	554.6	5.31	555.5	814.6	7.82
217.1	468.0	6.48	494.9	595.0	5.33	515.1	855.0	7.76
204.9	480.2	6.45	515.1	615.2	5.35	494.9	875.2	7.77
192.7	492.4	6.53	555.5	655.6	5.36	454.5	915.6	7.76
180.5	504.6	6.50	575.7	675.8	5.38	434.3	935.8	7.72
168.3	516.8	6.43	616.1	716.2	5.42	393.9	976.2	7.79
156.2	528.9	6.42	636.3	736.4	5.42	373.7	996.4	7.78
144.0	541.1	6.34	676.7	776.8	5.48	333.3	1036.8	7.80
131.8	553.3	6.31	696.9	797.0	5.51	313.1	1057.0	7.81
119.6	565.5	6.34	737.3	837.4	5.57	272.7	1097.4	7.87
107.4	577.7	6.30	757.6	857.7	5.61	252.4	1117.7	7.88
95.3	589.8	6.25	798.0	898.1	5.63	212.0	1158.1	7.89
83.1	602.0	6.22	818.2	918.3	5.63	191.8	1178.3	7.88
70.9	614.2	6.18	858.6	958.7	5.63	151.4	1218.7	7.87
58.7	626.4	6.19	878.8	978.9	5.65	131.2	1238.9	7.88
46.5	638.6	6.17	919.2	1019.3	5.65	90.8	1279.3	7.92
34.4	650.7	6.10	939.4	1039.5	5.67	70.6	1299.5	7.89
22.2	662.9	6.12	979.8	1079.9	5.69	30.2	1339.9	7.87
10.0	675.1	6.09	1000.0	1100.1	5.72	10.0	1360.1	7.80



# Frequency Mixer

# SYM-14H+

## Typical Performance Data

LO (MHz)	LO-RF ISOLATION (dB)			LO-IF ISOLATION (dB)		
	@LO (dBm)			@LO (dBm)		
	+14	+17	+20	+14	+17	+20
10.1	37.89	40.47	43.41	45.58	48.89	53.25
70.8	38.13	40.97	43.50	45.34	46.49	45.52
131.5	38.45	41.15	42.41	45.96	43.72	41.30
192.1	39.09	40.54	40.76	47.12	41.42	38.48
252.8	39.54	39.98	39.81	46.40	39.32	36.11
313.5	39.88	39.90	39.25	43.74	37.30	34.21
374.2	40.52	40.01	38.82	40.98	35.35	32.38
434.8	40.93	39.91	38.60	39.18	34.58	31.64
515.7	42.98	40.93	38.83	37.03	32.60	29.86
576.4	44.99	42.10	39.34	35.74	31.89	28.98
657.3	48.67	43.07	39.81	34.39	30.82	28.22
718.0	52.35	44.25	40.22	33.27	30.34	27.27
798.9	54.45	44.69	40.92	32.35	29.98	27.28
859.6	53.66	45.18	40.95	31.34	30.40	27.33
940.5	49.96	44.84	41.35	29.60	30.34	27.64
1001.2	49.23	46.06	41.78	27.53	30.28	27.41
1082.1	48.03	47.14	43.38	27.91	29.93	27.54
1142.7	44.97	49.70	46.47	26.59	30.92	28.32
1223.6	43.92	49.95	53.31	27.78	33.18	29.78
1284.3	41.67	47.01	54.71	26.94	35.71	31.11
1365.2	40.21	44.45	51.13	27.92	40.04	34.31
1425.9	38.77	42.11	47.21	26.22	35.88	40.02
1506.8	38.11	40.95	44.53	25.99	33.26	44.54
1567.5	37.59	40.34	43.61	25.01	30.81	38.32
1648.4	37.89	41.04	44.88	25.19	30.52	35.06
1709.0	38.09	41.84	45.81	25.15	29.73	33.09
1789.9	37.76	41.88	44.46	25.14	29.36	31.62
1850.6	37.38	40.24	42.03	25.39	28.82	30.48
1931.5	36.18	38.54	39.98	25.10	28.07	28.98
1992.2	35.80	38.02	39.57	25.44	27.70	28.20
2073.1	35.97	38.81	40.91	24.89	26.68	27.13
2133.8	38.16	42.46	44.20	24.16	25.82	26.47
2214.7	41.07	44.06	41.89	23.10	24.53	25.18
2275.4	42.90	42.29	39.49	22.73	24.06	24.74
2356.3	43.71	41.12	38.18	21.36	22.90	23.67
2416.9	44.94	39.69	36.86	20.48	22.00	23.05
2497.8	44.78	38.52	35.83	19.65	21.27	22.46
2558.5	43.35	38.02	35.65	19.04	20.73	22.10
2639.4	41.40	38.11	35.79	17.93	20.08	21.52
2700.1	39.32	37.82	36.12	17.36	19.53	21.23

RF (IN) (MHz)	LO (MHz)	RF-IF ISOLATION (dB)		
		@LO (dBm)		
		+14	+17	+20
10.1	40.1	36.33	36.20	38.74
70.8	100.8	35.90	36.78	37.30
131.5	161.5	36.64	37.08	37.25
192.1	222.1	37.53	38.43	39.08
252.8	282.8	38.74	39.36	39.86
313.5	343.5	40.02	40.22	40.93
374.2	404.2	41.42	41.26	42.06
434.8	464.8	41.59	42.25	43.63
515.7	545.7	41.84	43.09	43.27
576.4	606.4	43.80	44.15	43.26
657.3	687.3	44.59	43.27	42.01
718.0	748.0	43.65	41.83	40.64
798.9	828.9	43.55	41.52	40.60
859.6	889.6	44.45	43.24	41.60
940.5	970.5	48.48	46.32	44.10
1001.2	1031.2	53.99	47.52	44.56
1082.1	1112.1	52.47	48.36	44.49
1142.7	1172.7	48.83	45.21	42.46
1223.6	1253.6	43.74	41.73	39.70
1284.3	1314.3	39.85	38.01	36.56
1365.2	1395.2	35.40	34.10	33.47
1425.9	1455.9	33.73	32.72	32.40
1506.8	1536.8	32.62	32.05	32.07
1567.5	1597.5	32.87	32.34	32.32
1648.4	1678.4	33.56	33.31	32.71
1709.0	1739.0	34.39	33.83	33.15
1789.9	1819.9	34.69	34.09	33.22
1850.6	1880.6	34.62	34.12	33.17
1931.5	1961.5	34.22	33.91	33.31
1992.2	2022.2	34.23	34.33	33.88
2073.1	2103.1	33.94	34.27	33.94
2133.8	2163.8	32.10	32.58	32.93
2214.7	2244.7	30.24	30.43	30.86
2275.4	2305.4	29.43	29.19	29.01
2356.3	2386.3	28.81	28.05	27.46
2416.9	2446.9	28.63	27.49	26.69
2497.8	2527.8	27.87	26.52	25.65
2558.5	2588.5	26.49	25.42	24.69
2639.4	2669.4	24.92	24.29	23.93
2700.1	2730.1	23.84	23.57	23.60



# Frequency Mixer

# SYM-14H+

## Typical Performance Data

RF (IN) (MHz)	LO (MHz)	RF VSWR (:1)		
		@LO (dBm)		
		+14	+17	+20
10.1	40.1	1.36	1.20	1.10
70.8	100.8	1.37	1.23	1.14
131.5	161.5	1.42	1.28	1.19
192.1	222.1	1.50	1.36	1.27
252.8	282.8	1.56	1.41	1.32
313.5	343.5	1.67	1.50	1.40
374.2	404.2	1.82	1.62	1.52
434.8	464.8	1.91	1.71	1.62
515.7	545.7	2.05	1.84	1.75
576.4	606.4	2.08	1.92	1.85
657.3	687.3	2.17	2.02	1.95
718.0	748.0	2.23	2.11	2.04
798.9	828.9	2.35	2.20	2.11
859.6	889.6	2.38	2.23	2.14
940.5	970.5	2.52	2.29	2.19
1001.2	1031.2	2.53	2.32	2.21
1082.1	1112.1	2.68	2.37	2.22
1142.7	1172.7	2.68	2.39	2.22
1223.6	1253.6	2.73	2.42	2.24
1284.3	1314.3	2.77	2.45	2.27
1365.2	1395.2	2.84	2.54	2.37
1425.9	1455.9	2.92	2.63	2.46
1506.8	1536.8	3.00	2.75	2.56
1567.5	1597.5	3.02	2.77	2.59
1648.4	1678.4	2.94	2.72	2.59
1709.0	1739.0	2.90	2.68	2.55
1789.9	1819.9	2.80	2.62	2.49
1850.6	1880.6	2.76	2.58	2.43
1931.5	1961.5	2.59	2.43	2.30
1992.2	2022.2	2.48	2.31	2.18
2073.1	2103.1	2.29	2.12	2.03
2133.8	2163.8	2.23	2.09	1.99
2214.7	2244.7	2.22	2.10	1.97
2275.4	2305.4	2.19	2.07	1.92
2356.3	2386.3	2.09	1.95	1.81
2416.9	2446.9	2.00	1.85	1.73
2497.8	2527.8	1.93	1.77	1.65
2558.5	2588.5	1.89	1.73	1.60
2639.4	2669.4	1.89	1.70	1.53
2700.1	2730.1	1.85	1.64	1.48

LO (MHz)	LO VSWR (:1)		
	@LO (dBm)		
	+14	+17	+20
10.1	1.02	1.60	2.35
70.8	1.10	1.61	2.39
131.5	1.13	1.67	2.48
192.1	1.17	1.66	2.37
252.8	1.21	1.57	2.28
313.5	1.24	1.57	2.21
374.2	1.24	1.57	2.23
434.8	1.24	1.47	2.04
515.7	1.32	1.38	1.94
576.4	1.38	1.32	1.82
657.3	1.49	1.32	1.73
718.0	1.65	1.32	1.65
798.9	1.76	1.32	1.55
859.6	1.89	1.32	1.46
940.5	1.92	1.31	1.36
1001.2	2.22	1.34	1.28
1082.1	2.07	1.33	1.17
1142.7	2.40	1.38	1.11
1223.6	2.20	1.35	1.09
1284.3	2.43	1.43	1.17
1365.2	2.25	1.47	1.30
1425.9	2.51	1.58	1.41
1506.8	2.35	1.64	1.57
1567.5	2.46	1.73	1.67
1648.4	2.30	1.77	1.81
1709.0	2.27	1.83	1.88
1789.9	2.22	1.88	2.00
1850.6	2.13	1.92	2.06
1931.5	2.08	1.98	2.13
1992.2	2.02	2.02	2.20
2073.1	1.97	2.03	2.24
2133.8	1.92	2.05	2.27
2214.7	1.88	2.06	2.28
2275.4	1.91	2.13	2.37
2356.3	1.91	2.15	2.36
2416.9	1.94	2.19	2.40
2497.8	1.99	2.22	2.41
2558.5	2.03	2.25	2.43
2639.4	2.05	2.28	2.45
2700.1	2.10	2.31	2.47

IF (OUT) (MHz)	IF VSWR @LO=1370.1MHz (:1)		
	@LO (dBm)		
	+14	+17	+20
10.0	1.15	1.39	1.61
30.2	1.21	1.27	1.56
50.4	1.21	1.24	1.62
70.6	1.24	1.24	1.64
90.8	1.26	1.25	1.58
111.0	1.25	1.24	1.54
131.2	1.24	1.27	1.60
151.4	1.26	1.27	1.62
171.6	1.28	1.25	1.58
191.8	1.26	1.28	1.58
212.0	1.27	1.31	1.59
232.2	1.29	1.30	1.58
252.4	1.28	1.29	1.59
272.7	1.28	1.34	1.63
292.9	1.30	1.35	1.61
313.1	1.30	1.33	1.57
333.3	1.27	1.36	1.62
353.5	1.28	1.38	1.65
373.7	1.28	1.35	1.62
393.9	1.27	1.35	1.61
434.3	1.27	1.38	1.62
454.5	1.25	1.36	1.61
494.9	1.24	1.38	1.63
515.1	1.23	1.34	1.59
555.5	1.21	1.37	1.62
575.7	1.22	1.34	1.58
616.1	1.19	1.33	1.60
636.3	1.20	1.32	1.57
676.7	1.17	1.29	1.54
696.9	1.18	1.29	1.56
737.3	1.16	1.26	1.52
757.6	1.15	1.27	1.50
798.0	1.16	1.22	1.48
818.2	1.14	1.24	1.52
858.6	1.16	1.21	1.44
878.8	1.15	1.22	1.44
919.2	1.17	1.18	1.45
939.4	1.17	1.17	1.43
979.8	1.18	1.16	1.37
1000.0	1.20	1.14	1.36

## Harmonics Tables

RF HARMONICS ORDER

	(-dBm)	(-dBc)										
0	-	-	6	25	7	39	12	38	23	38	26	49
1	-	36	+0	48	13	45	24	52	44	51	41	59
2	88	58	54	53	49	62	49	77	52	70	52	69
3	>100	91	71	87	78	84	80	83	67	85	78	85
4	>100	>93	88	>93	87	>93	85	>93	88	>93	>93	>93
5	>100	>93	>93	>93	>93	>93	>93	>93	>93	>93	>93	>93
6	>100	>93	>93	>93	>93	>93	>93	>93	>93	>93	>93	>93
7	>100	>93	>93	>93	>93	>93	>93	>93	>93	>93	>93	>93
8	>100	>93	>93	>93	>93	>93	>93	>93	>93	>93	>93	>93
9	>100	>93	>93	>93	>93	>93	>93	>93	>93	>93	>93	>93
10	>100	>93	>93	>93	>93	>93	>93	>93	>93	>93	>93	>93
	RF CAL	0	1	2	3	4	5	6	7	8	9	10

### LO HARMONICS ORDER

Test conditions: RF IN: 750.1 MHz; -1.00 dBm.  
 LO IN: 780.01 MHz; +17.00 dBm  
 IF OUT: 29.91 MHz; -7.38 dBm

RF HARMONICS ORDER

	(-dBm)	(-dBc)										
0	-	-	16	36	18	48	24	52	36	54	39	69
1	-	37	+0	49	13	45	25	55	45	54	45	64
2	73	47	45	42	40	50	40	62	43	62	46	60
3	>100	84	45	71	57	75	52	65	51	69	59	65
4	>100	71	77	73	69	73	65	74	58	71	72	71
5	>100	83	63	82	60	83	63	81	60	87	69	90
6	>100	93	83	82	81	85	80	81	75	81	88	80
7	>100	94	92	97	77	97	81	92	77	91	77	>103
8	>100	>103	98	>103	97	>103	95	>103	89	101	90	97
9	>100	>103	>103	>103	>103	102	93	103	95	102	92	101
10	>100	>103	>103	>103	>103	>103	>103	>103	102	>103	102	102
	RF CAL	0	1	2	3	4	5	6	7	8	9	10

### LO HARMONICS ORDER

Test conditions: RF IN: 750.1 MHz; 9.00 dBm.  
 LO IN: 780.01 MHz; +17.00 dBm  
 IF OUT: 29.91 MHz; 2.54 dBm

- Notes: 1. All Harmonics are in (dBc) relative to IF OUTPUT.  
 2. + entry denotes harmonics are in (dBc) above IF OUTPUT.  
 3. RF Cal represent the Harmonics level of the RF input signal to the mixer.

REV. X2  
 SYM-14H+  
 100818  
 Page 5 of 5



IF/RF MICROWAVE COMPONENTS • ISO 9001 ISO 14001 AS 9100 CERTIFIED • RoHS compliant  
 P.O. Box 350166, Brooklyn, New York 11235-0006 (718) 934-4500 Fax (718) 332-4661



The Design Engineers Search Engine finds the model you need, Instantly • For detailed performance specs & shopping online see [minicircuits.com](http://www.minicircuits.com)



# Frequency Mixer

# SYM-14H+

## Typical Performance Curves

Conversion Loss @ IF=30MHz

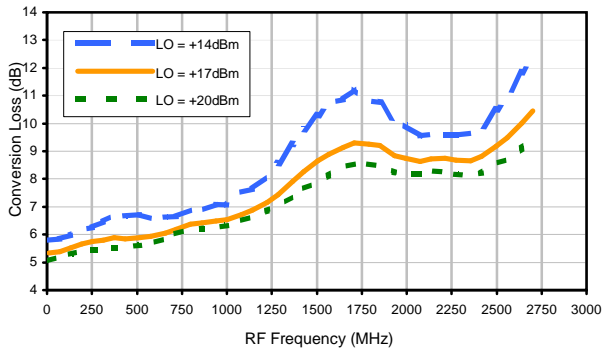

Conversion Loss vs. IF @ RF=685.1MHz

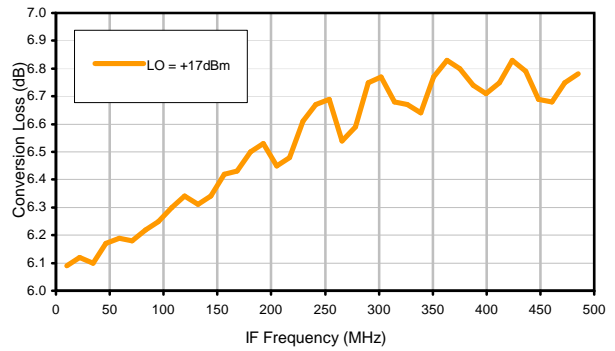

Conversion Loss vs. IF @ RF=100.1MHz

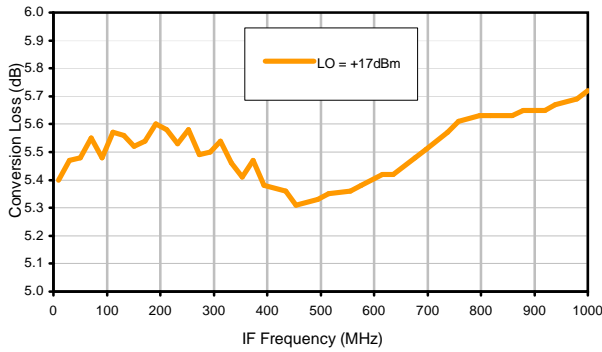

Conversion Loss vs. IF @ RF=1370.1MHz

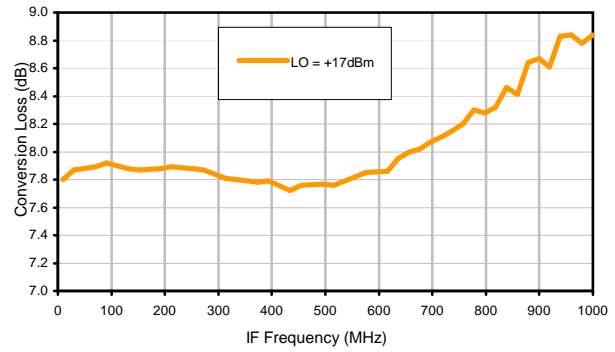

IP3 Input

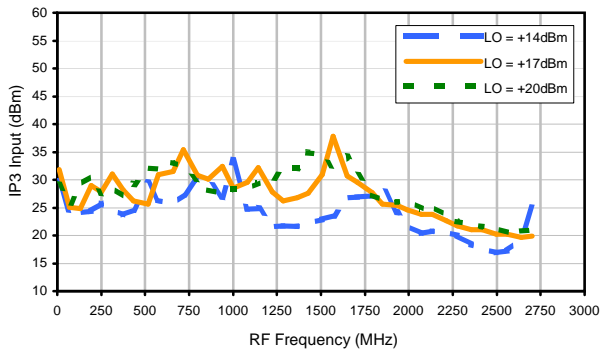

Compression @ RF IN=+14dBm

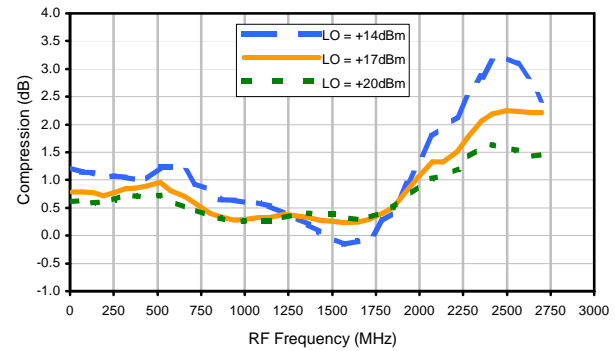



## Typical Performance Curves

### LO-RF Isolation

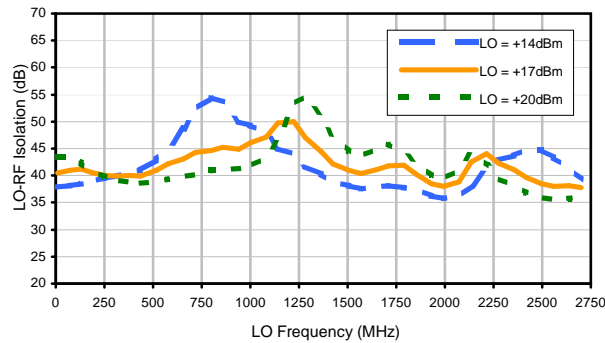

### LO-IF Isolation

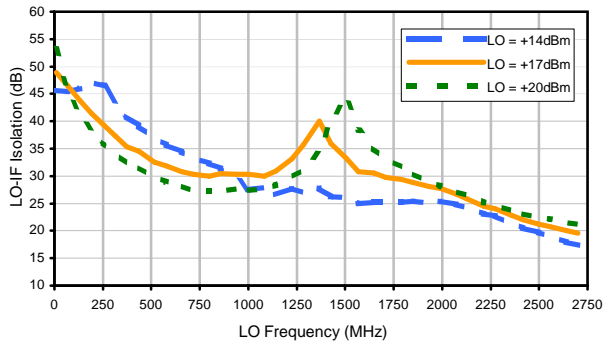

### RF-IF Isolation

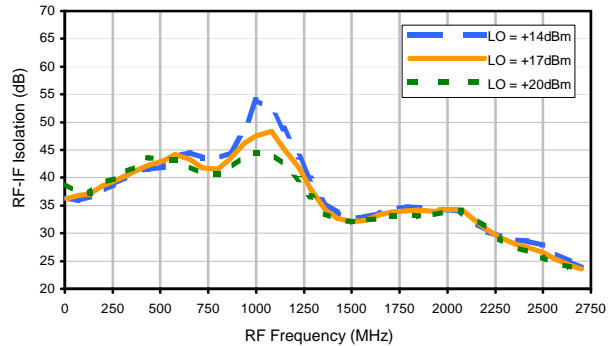

### RF VSWR

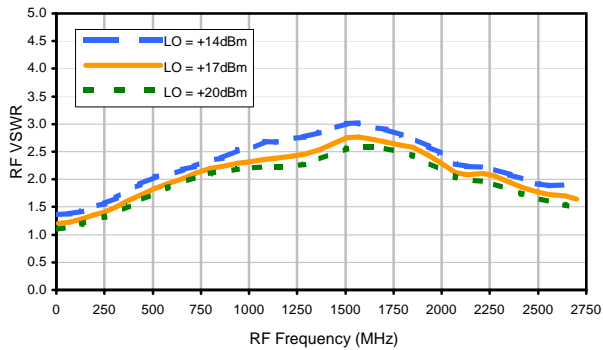

### LO VSWR

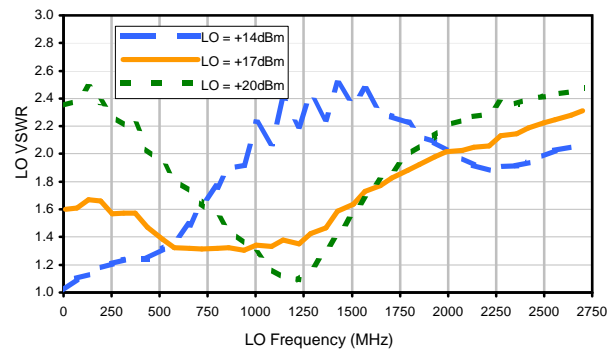

### IF VSWR

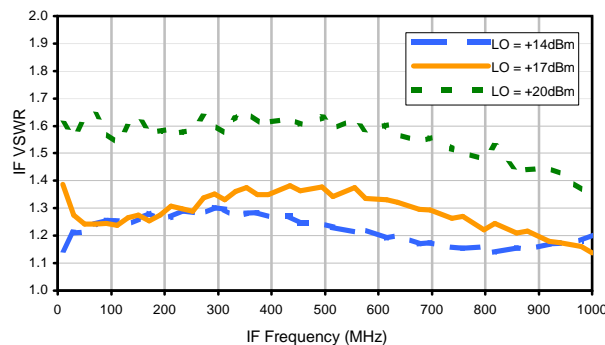

## Harmonics Tables

RF HARMONICS ORDER

	(-dBm)	(-dBc)										
0	-	-	6	25	7	39	12	38	23	38	26	49
1	-	36	+0	48	13	45	24	52	44	51	41	59
2	88	58	54	53	49	62	49	77	52	70	52	69
3	>100	91	71	87	78	84	80	83	67	85	78	85
4	>100	>93	88	>93	87	>93	85	>93	88	>93	>93	>93
5	>100	>93	>93	>93	>93	>93	>93	>93	>93	>93	>93	>93
6	>100	>93	>93	>93	>93	>93	>93	>93	>93	>93	>93	>93
7	>100	>93	>93	>93	>93	>93	>93	>93	>93	>93	>93	>93
8	>100	>93	>93	>93	>93	>93	>93	>93	>93	>93	>93	>93
9	>100	>93	>93	>93	>93	>93	>93	>93	>93	>93	>93	>93
10	>100	>93	>93	>93	>93	>93	>93	>93	>93	>93	>93	>93
	RF CAL	0	1	2	3	4	5	6	7	8	9	10

### LO HARMONICS ORDER

Test conditions: RF IN: 750.1 MHz; -1.00 dBm.  
 LO IN: 780.01 MHz; +17.00 dBm  
 IF OUT: 29.91 MHz; -7.38 dBm

RF HARMONICS ORDER

	(-dBm)	(-dBc)										
0	-	-	16	36	18	48	24	52	36	54	39	69
1	-	37	+0	49	13	45	25	55	45	54	45	64
2	73	47	45	42	40	50	40	62	43	62	46	60
3	>100	84	45	71	57	75	52	65	51	69	59	65
4	>100	71	77	73	69	73	65	74	58	71	72	71
5	>100	83	63	82	60	83	63	81	60	87	69	90
6	>100	93	83	82	81	85	80	81	75	81	88	80
7	>100	94	92	97	77	97	81	92	77	91	77	>103
8	>100	>103	98	>103	97	>103	95	>103	89	101	90	97
9	>100	>103	>103	>103	>103	102	93	103	95	102	92	101
10	>100	>103	>103	>103	>103	>103	>103	>103	102	>103	102	102
	RF CAL	0	1	2	3	4	5	6	7	8	9	10

### LO HARMONICS ORDER

Test conditions: RF IN: 750.1 MHz; 9.00 dBm.  
 LO IN: 780.01 MHz; +17.00 dBm  
 IF OUT: 29.91 MHz; 2.54 dBm

- Notes: 1. All Harmonics are in (dBc) relative to IF OUTPUT.  
 2. + entry denotes harmonics are in (dBc) above IF OUTPUT.  
 3. RF Cal represent the Harmonics level of the RF input signal to the mixer.

REV. X2  
 SYM-14H+  
 100818  
 Page 3 of 3



IF/RF MICROWAVE COMPONENTS • ISO 9001 ISO 14001 AS 9100 CERTIFIED • RoHS compliant  
 P.O. Box 350166, Brooklyn, New York 11235-0006 (718) 934-4500 Fax (718) 332-4661



The Design Engineers Search Engine finds the model you need, Instantly • For detailed performance specs & shopping online see



## Outline Dimensions

TTT166  
TTT167

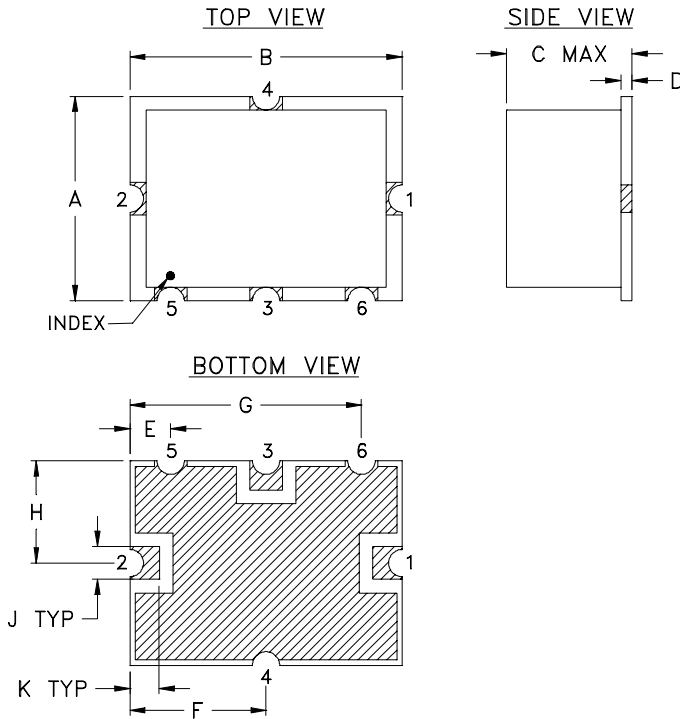

## PCB Land Pattern

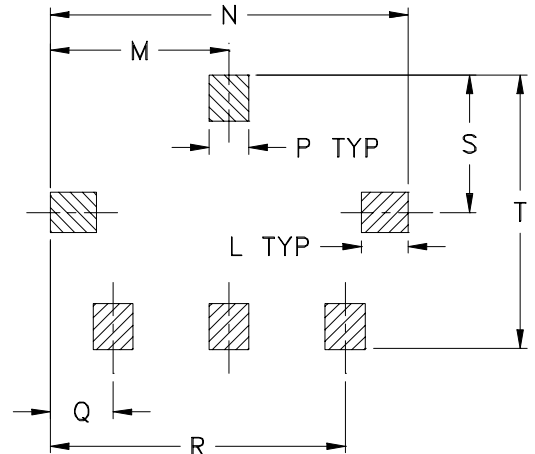

Suggested Layout,  
Tolerance to be within  $\pm .002$

CASE #	A	B	C	D	E	F	G	H	J	K	L	M	N
TTT166	.38 (9.65)	.50 (12.70)	.15 (3.81)	.020 (0.51)	.075 (1.91)	.250 (6.35)	.425 (10.80)	.187 (4.75)	.050 (1.27)	.050 (1.27)	.070 (1.78)	.270 (6.86)	.540 (13.72)
TTT167			.23 (5.84)										

CASE #	P	Q	R	S	T	WT. GRAM
TTT166	.060 (1.52)	.095 (2.41)	.445 (11.30)	.208 (5.28)	.415 (10.54)	.8
TTT167						.8

Dimensions are in inches (mm). Tolerances: 2 Pl.  $\pm .01$ ; 3 Pl.  $\pm .005$

### Note:

- Case material: Plastic.
- Base material: Printed wiring laminate.
- Termination finish:
  - For RoHS Case Styles: 3-5  $\mu$  inch (.08-.13 microns) Gold over 120-240  $\mu$  inch (3.05-6.10 microns) Nickel plate. All models, (+) suffix.
  - For RoHS-5 Case Styles: Tin-Lead plate. All models, no (+) suffix.

# Tape & Reel Packaging TR-F12

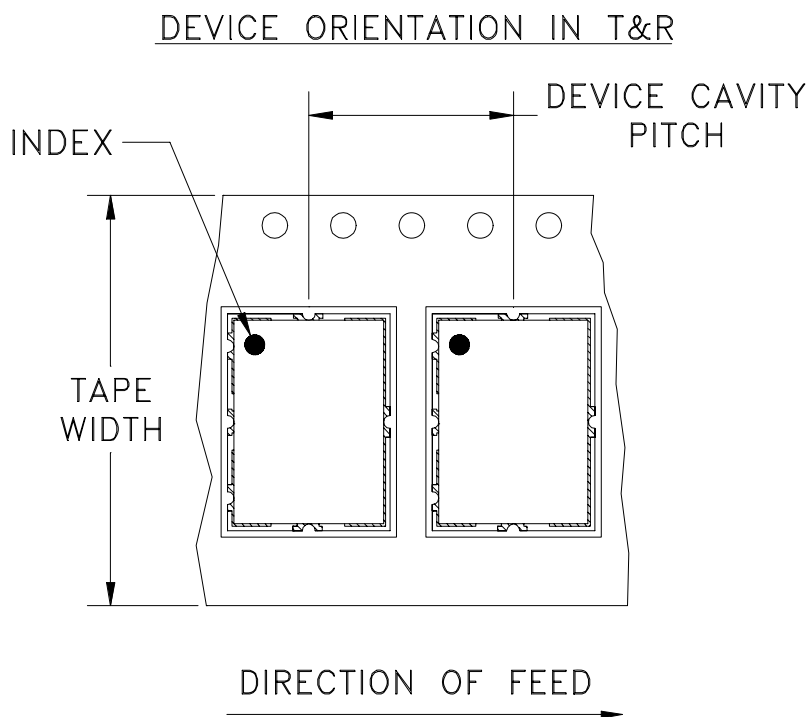

Tape Width, mm	Device Cavity Pitch, mm	Reel Size, inches	Devices per Reel	
24	12	7	Small quantity standards (see note)	10
				20
				50
				100
				200
		13	Standard	500

Note: Please Consult individual model data sheet to determine device per reel availability.

Mini-Circuits carrier tape materials provide protection from ESD (Electro-Static Discharge) during handling and transportation. Tapes are static dissipative and comply with industry standards EIA-481/EIA-541.

Go to: [www.minicircuits.com/pages/pdfs/tape.pdf](http://www.minicircuits.com/pages/pdfs/tape.pdf)



**Distribution Centers** NORTH AMERICA 800-654-7949 • 417-335-5935 • Fax 417-335-5945 • EUROPE 44-1252-832600 • Fax 44-1252-837010

Mini-Circuits ISO 9001 & ISO 14001 Certified

INTERNET <http://www.minicircuits.com>

P.O. Box 350166, Brooklyn, New York 11235-0003 (718) 934-4500 Fax (718) 332-4661

THIRD ANGLE PROJECTION

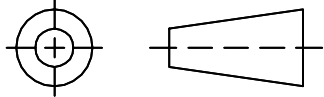

REVISIONS

REV	ECN No.	DESCRIPTION	DATE	DR	AUTH
A	M86762	ADDED CONNECTIONS "lp & lq"	05/23/03	MMG	WL
B	M94598	ADDED CONNECTION "hk"	10/08/04	MMG	HY
C	M102713	UPDATED NOTES & DESCRIPTION	01/14/06	GF	IL
D	M132989	UPDATED NOTE 2	08/24/11	GF	DJ

SUGGESTED MOUNTING CONFIGURATION FOR  
TTT166/167 CASE STYLE, "hk"/"lp"/"lq"  
"x"/"ck"/"ec" PIN CONNECTIONS

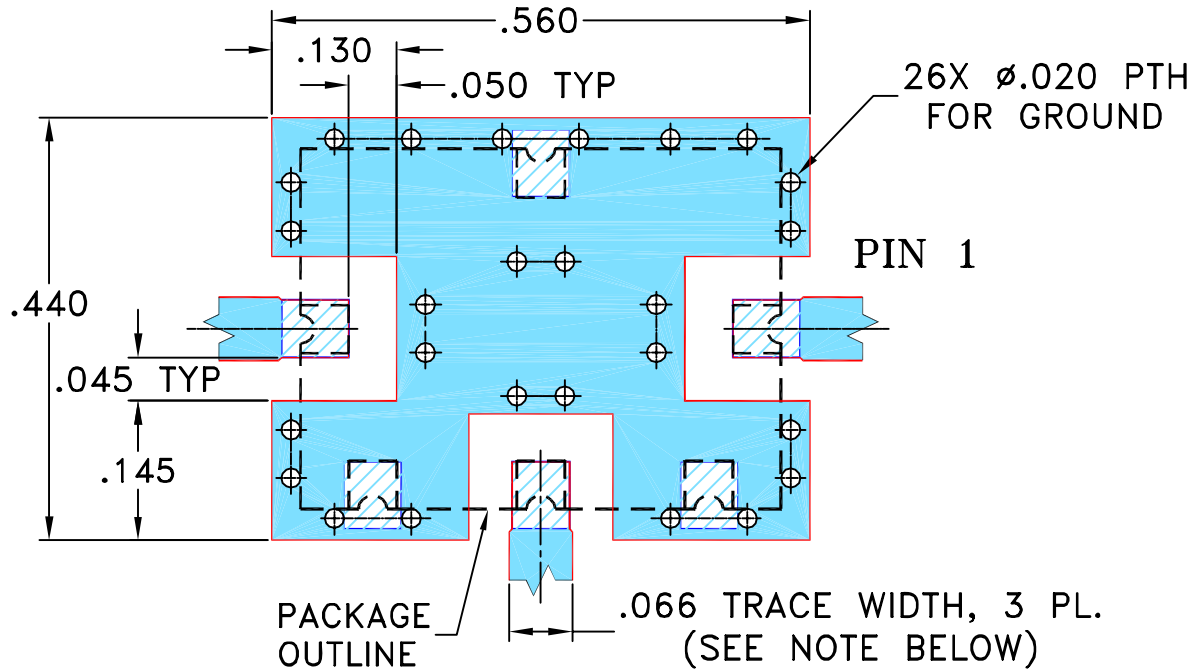

NOTE:

1. TRACE WIDTH IS SHOWN FOR ROGERS R04350B WITH DIELECTRIC THICKNESS .030" ± .002"; COPPER: 1/2 OZ. EACH SIDE. FOR OTHER MATERIALS TRACE WIDTH MAY NEED TO BE MODIFIED.
2. THE USE OF SOLDER MASK OVER THE GROUND AREA UNDER THE UNIT AS SHOWN IS RECOMMENDED TO PREVENT POTENTIAL SHORTING. IF USER CHOOSES TO EXPOSE METAL UNDER THE ENTIRE UNIT GROUND PAD FOR IMPROVED GROUNDING, IT IS RECOMMENDED A SOLDER MASK DAM BE APPLIED AROUND EACH GROUND PAD TO ENSURE FILLET AND CONNECTION AT GROUND PADS.
3. BOTTOM SIDE OF THE PCB IS CONTINUOUS GROUND PLANE.

 DENOTES PCB COPPER LAYOUT WITH SMOBC (SOLDER MASK OVER BARE COPPER), SEE NOTE 2.

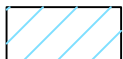
 DENOTES COPPER LAND PATTERN FREE OF SOLDER MASK

UNLESS OTHERWISE SPECIFIED	INITIALS	DATE
DIMENSIONS ARE IN INCHES	GF	03/18/03
TOLERANCES ON:	IL	04/15/03
2 PL DECIMALS ±	DJ	04/15/03
3 PL DECIMALS ± .005		
ANGLES ±		
FRACTIONS ±		

 **Mini-Circuits®** 13 Neptune Avenue  
Brooklyn NY 11235

PL, hk/lp/lq/x/ck/ec, TTT166/167,  
SYM/HJK/SYAS/SYPD, TB-12

SIZE	CODE IDENT	DRAWING NO:	REV:
A	15542	98-PL-079	D
FILE:	98PL079	SCALE: 5:1	SHEET: 1 OF 1

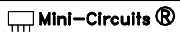
 Mini-Circuits®  
THIS DOCUMENT AND ITS CONTENTS ARE THE PROPERTY OF MINI-CIRCUITS. EXCEPT FOR USE EXPRESSLY GRANTED, IN WRITING, TO ITS VENDORS, VENDEE AND THE UNITED STATES GOVERNMENT, MINI-CIRCUITS RESERVES ALL PROPRIETARY DESIGN, USE, MANUFACTURING AND REPRODUCTION RIGHTS THERETO. THESE CONTENTS SHALL NOT BE USED, DUPLICATED OR DISCLOSED TO ANY OUTSIDE PARTY, IN WHOLE OR IN PART, WITHOUT WRITTEN PERMISSION OF MINI-CIRCUITS.

# Evaluation Board and Circuit

For Pin Connections Refer to Data Sheet of the DUT

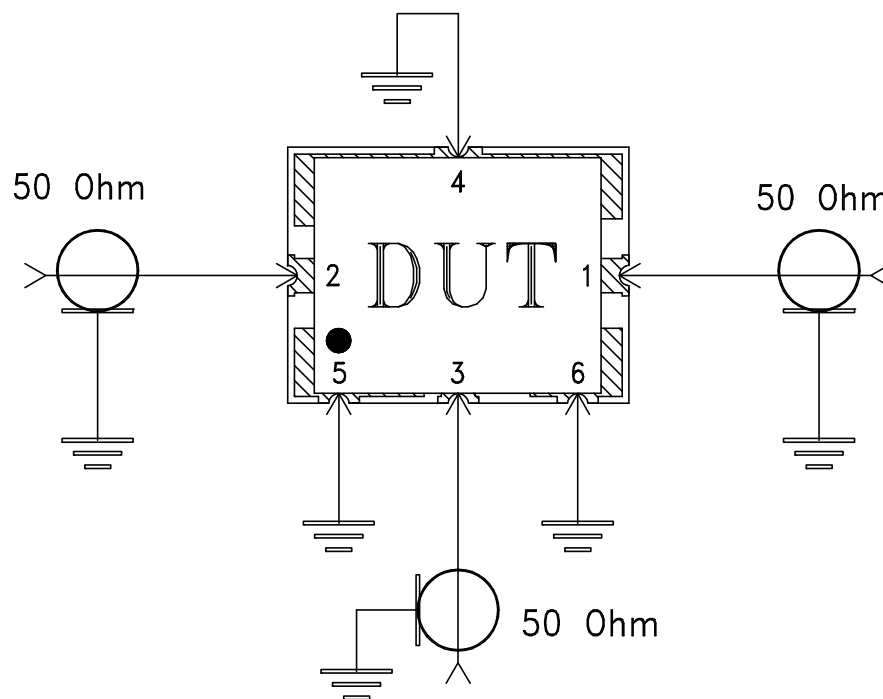
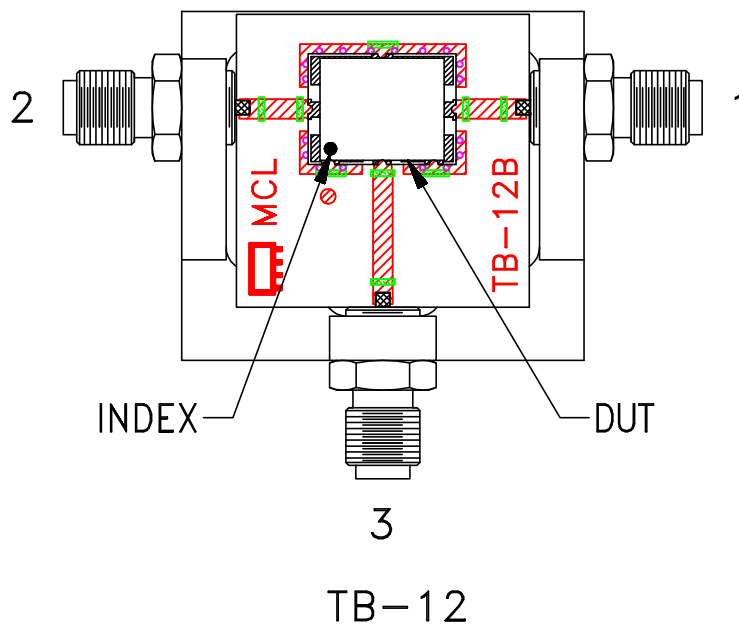

Schematic Diagram

## Notes:

1. SMA Female connectors.
2. PCB Material: Rogers R04350 or equivalent, Dielectric Constant=3.5, Thickness=.030 inch.

 **Mini-Circuits®**



All Mini-Circuits products are manufactured under exacting quality assurance and control standards, and are capable of meeting published specifications after being subjected to any or all of the following physical and environmental test.

Specification	Test/Inspection Condition	Reference/Spec
Operating Temperature	-40° to 85°C Ambient Environment	Individual Model Data Sheet
Storage Temperature	-55° to 100° C Ambient Environment	Individual Model Data Sheet
Humidity	90 to 95% RH, 240 hours, 50°C	MIL-STD-202, Method 103, Condition A, Except 50°C and end-point electrical test done within 12 hours
Thermal Shock	-55° to 100°C, 100 cycles	MIL-STD-202, Method 107, Condition A-3, except +100°C
Solder Reflow Heat	Sn-Pb Eutetic Process: 225°C peak Pb-Free Process 245° - 250°C peak	J-STD-020, Table 4-1, 4-2 and 5-2, Figure 5-1
Solderability	10X Magnification	J-STD-002, 95% Coverage
Vibration (High Frequency)	20g peak, 10-2000 Hz, 12 times in each of three perpendicular directions (total 36)	MIL-STD-202, Method 204, Condition D
Mechanical Shock	50g, 11 ms, 1/2-sine, 18 shocks: 3 each direction, each of 3 axes	MIL-STD-202, Method 213, Condition A
Marking Resistance to Solvents	Isopropyl alcohol + mineral spirits at 25°C; terpene defluxer at 25°C; distilled water + proylene glycol monomethyl ether + monoethanolamine at 63°C to 70°C	MIL-STD-202, Method 215