



ULTRA HIGH DYNAMIC RANGE

Monolithic Amplifier

PHA-1+

50Ω 0.05 to 6 GHz

THE BIG DEAL

- Ultra High IP3
- High Pout, P1dB 22 dBm typ. at 2 GHz, 5V
- Low noise figure, 2.2 dB @2 GHz, 5V
- Usable to 4.0V
- Broadband High Dynamic Range without External Matching Components
- May be used as a replacement to WJ AH1^{a,b}

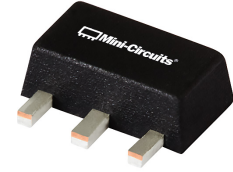

Generic photo used for illustration purposes only

CASE STYLE: DF782

+RoHS Compliant

The +Suffix identifies RoHS Compliance. See our web site for RoHS Compliance methodologies and qualifications

APPLICATIONS

- Base station infrastructure
- Portable Wireless
- CATV & DBS
- MMDS & Wireless LAN
- LTE

LTE & TD-SCDMA Performance

FREE X-PARAMETERS*

PRODUCT OVERVIEW

PHA-1+ (RoHS compliant) is an advanced wideband amplifier fabricated using E-PHEMT technology and offers extremely high dynamic range over a broad frequency range and with low noise figure. In addition, the PHA-1+, unlike competitive models, has good input and output return loss over a broad frequency range without the need for external matching components and has demonstrated excellent reliability. It has repeatable performance from lot to lot and is enclosed in a SOT-89 package for very good thermal performance.

KEY FEATURES

Feature	Advantages
Broad Band: 0.05 to 6.0 GHz	Broadband covering primary wireless communications bands: Cellular, PCS, LTE, WiMAX
Extremely High IP3 Versus DC power Consumption 42 dBm typical at 2 GHz	The PHA-1+ matches industry leading IP3 performance relative to device size and power consumption. The combination of the design and E-PHEMT Structure provides enhanced linearity over a broad frequency range as evidence in the IP3 being typically 20 dB above the P 1dB point. This feature makes this amplifier ideal for use in: <ul style="list-style-type: none"> • Driver amplifiers for complex waveform up converter paths • Drivers in linearized transmit systems • Secondary amplifiers in ultra High Dynamic range receivers
No External Matching Components Required	Unlike competing products, Mini-Circuits PHA-1+ provides Input and Output Return Loss of 14-21 dB up to 4 GHz without the need for any external matching components
Low Noise Figure: 2.3dB typ. up to 4 GHz 3.5dB typ. up to 6 GHz	A unique feature of the PHA-1+ which separates this design from all competitors is the low noise figure performance in combination with the high dynamic range.

a. Suitability for model replacement within a particular system must be determined by and is solely the responsibility of the customer based on, among other things, electrical performance criteria, stimulus conditions, application, compatibility with other components and environmental conditions and stresses.

b. The WJ AH1 part number is used for identification and comparison purposes only.

* X-parameters is a registered trademark of Agilent Technologies, Inc. The X-parameters format and underlying equations are open and documented.

For more information, refer to X-parameters Open Documentation, Trademark Usage & Partnerships

REV. F
ECO-010314
PHA-1+
MCL NY
211026





ULTRA HIGH DYNAMIC RANGE

Monolithic Amplifier

PHA-1+

ELECTRICAL SPECIFICATIONS AT 25°C, UNLESS NOTED

Parameter	Condition (GHz)	Vd=5.0V ⁽¹⁾			Vd=4.5V ⁽²⁾	Vd=4.0V ⁽²⁾	Units
		Min.	Typ.	Max.	Typ.	Typ.	
Frequency range		0.05		6.0	0.05-6.0	0.05-6.0	GHz
Gain	0.05	15.4	17.2	19.4	17.5	17.3	dB
	0.8	14.1	15.7	17.3	15.5	15.2	
	2.0	—	13.5	—	13.4	13.1	
	3.0	—	11.8	—	11.8	11.4	
	4.0	9.6	10.7	12.3	10.7	10.4	
	6.0	—	9.7	—	9.6	9.2	
Input Return Loss	0.05	—	11.7	—	10.7	10.6	dB
	0.8	13.0	17.0	—	16.5	16.1	
	2.0	—	11.3	—	11.7	11.4	
	3.0	—	10.2	—	10.4	10.1	
	4.0	—	10.2	—	9.7	9.5	
	6.0	—	8.6	—	7.3	7.3	
Output Return Loss	0.05	—	14.5	—	13.7	13.5	dB
	0.8	13.0	20.8	—	19.5	18.3	
	2.0	—	17.1	—	16.1	14.7	
	3.0	—	15.3	—	14.1	13.4	
	4.0	—	13.8	—	12.8	12.2	
	6.0	—	11.0	—	10.2	9.7	
Reverse Isolation	2.0		19.9		19.3	18.9	dB
Output Power @1 dB compression	0.05	20.0	22.2	—	21.5	20.0	dBm
	0.8	20.0	22.6	—	21.3	19.9	
	2.0	20.0	22.4	—	21.4	19.9	
	3.0	—	22.7	—	21.6	20.1	
	4.0	—	22.7	—	21.5	20.1	
	6.0	—	21.6	—	20.3	19.2	
Output IP3	0.05	—	41.4	—	36.8	34.4	dBm
	0.8	37.0	41.1	—	40.0	36.3	
	2.0	—	42.0	—	37.1	34.0	
	3.0	—	42.3	—	36.3	33.3	
	4.0	—	40.8	—	35.8	32.7	
	6.0	—	38.8	—	33.9	31.2	
Noise Figure	0.05	—	1.7	—	1.9	1.8	dB
	1.0	—	1.9	—	2.3	2.1	
	2.0	—	2.2	—	2.4	2.2	
	3.0	—	2.3	—	2.5	2.5	
	4.0	—	2.7	—	3.0	2.9	
	6.0	—	3.5	—	3.7	3.6	
Device Operating Voltage		4.8	5.0	5.2	4.5	4.0	V
Device Operating Current		110	146	180	119	95	mA
Device Current Variation vs. Temperature ⁽³⁾			-12		68	67	μA/°C
Device Current Variation vs Voltage			0.054		0.052	0.052	mA/mV
Thermal Resistance, junction-to-ground lead			60		60	60	°C/W

(1) Measured on Mini-Circuits Characterization test board TB-313. See Characterization Test Circuit (Fig. 1)

(2) Measured on Mini-Circuits test fixture 90-6-20-26 characterization Circuit (Fig.1), except replace TB-313 with 90-6-20-26

(3) (Current at 85°C – Current at -45°C)/130





ULTRA HIGH DYNAMIC RANGE

Monolithic Amplifier

PHA-1+

MAXIMUM RATINGS

Parameter	Ratings
Operating Temperature (ground lead)	-40°C to 85°C
Storage Temperature	-65°C to 150°C
Operating Current at 5V	210 mA
Power Dissipation	1 W
Input Power (CW)	24 dBm
DC Voltage on Pin 3	6 V

Permanent damage may occur if any of these limits are exceeded. Electrical maximum ratings are not intended for continuous normal operation.

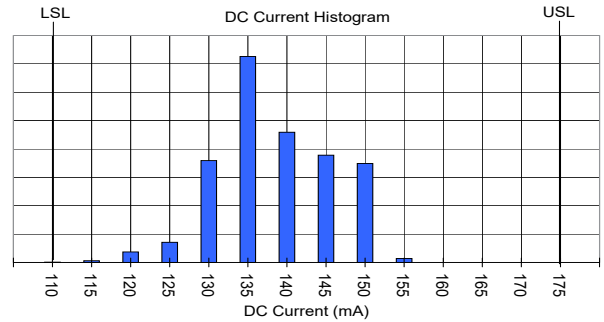

SIMPLIFIED SCHEMATIC AND PIN DESCRIPTION

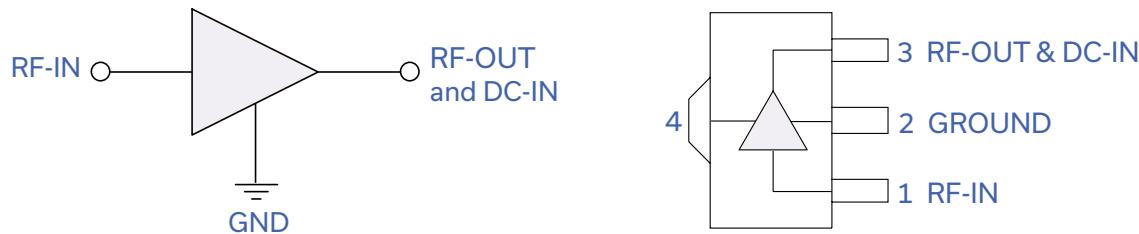

Function	Pin Number	Description
RF IN	1	RF input pin. This pin requires the use of an external DC blocking capacitor chosen for the frequency of operation.
RF-OUT and DC-IN	3	RF output and bias pin. DC voltage is present on this pin; therefore a DC blocking capacitor is necessary for proper operation. An RF choke is needed to feed DC bias without loss of RF signal due to the bias connection, as shown in "Recommended Application Circuit", Fig. 2
GND	2,4	Connections to ground. Use via holes as shown in "Suggested Layout for PCB Design" to reduce ground path inductance for best performance.

a. Suitability for model replacement within a particular system must be determined by and is solely the responsibility of the customer based on, among other things, electrical performance criteria, stimulus conditions, application, compatibility with other components and environmental conditions and stresses.
b. The WJ AH1 part number is used for identification and comparison purposes only.

CHARACTERIZATION TEST CIRCUIT

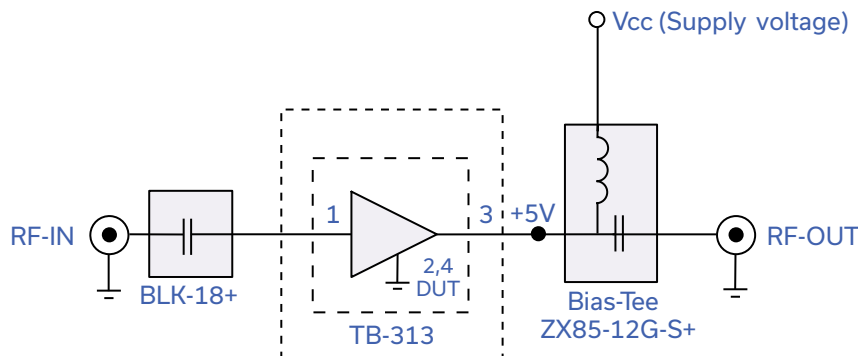

Fig 1. Block Diagram of Test Circuit used for characterization. (DUT soldered on Mini-Circuits Characterization test board TB-313)

Gain, Return loss, Output power at 1dB compression (P1 dB) , output IP3 (OIP3) and noise figure measured using Agilent's N5242A PNA-X microwave network analyzer.

Conditions:

1. Gain and Return loss: Pin= -25dBm
2. Output IP3 (OIP3): Two tones, spaced 1 MHz apart, 5 dBm/ tone at output.





RECOMMENDED APPLICATION CIRCUIT

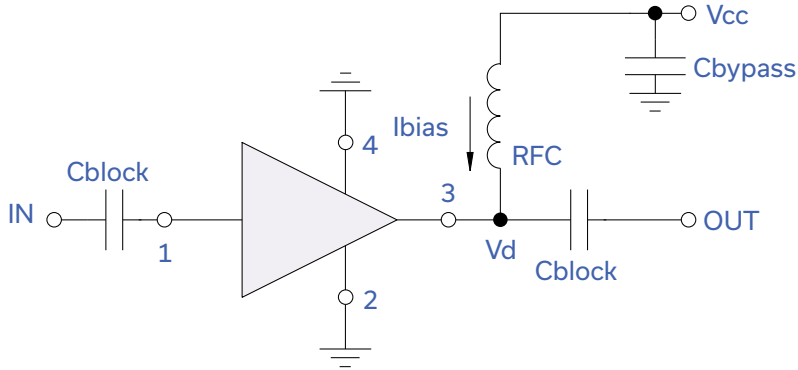
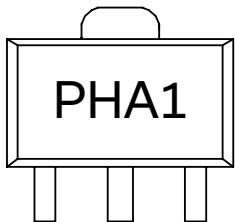

Fig 2. Test Board includes case, connectors, and components soldered to PCB

PRODUCT MARKING



Marking may contain other features or characters for internal lot control



ULTRA HIGH DYNAMIC RANGE

Monolithic Amplifier

PHA-1+

ADDITIONAL DETAILED TECHNICAL INFORMATION IS AVAILABLE ON OUR DASH BOARD. TO ACCESS [CLICK HERE](#)

Performance Data	Data Table Swept Graphs S-Parameter (S2P Files) Data Set (.zip file)
Case Style	DF782 (SOT 89) Plastic package, exposed paddle lead finish: matte-tin
Tape & Reel Standard quantities available on reel	F55 7" reels with 20, 50, 100, 200, 500 or 1K devices
Suggested Layout for PCB Design	PL-313
Evaluation Board	TB-545-1+
Environmental Ratings	ENV08T1

ESD RATING

Human Body Model (HBM): Class 1A (250 to <500V) in accordance with ANSI/ESD STM 5.1 - 2001

Machine Model (MM): Class M1 (>25V) in accordance with ANSI/ESD STM5.2-1999

MSL RATING

Moisture Sensitivity: MSL1 in accordance with IPC/JEDEC J-STD-020D

MSL TEST FLOW CHART

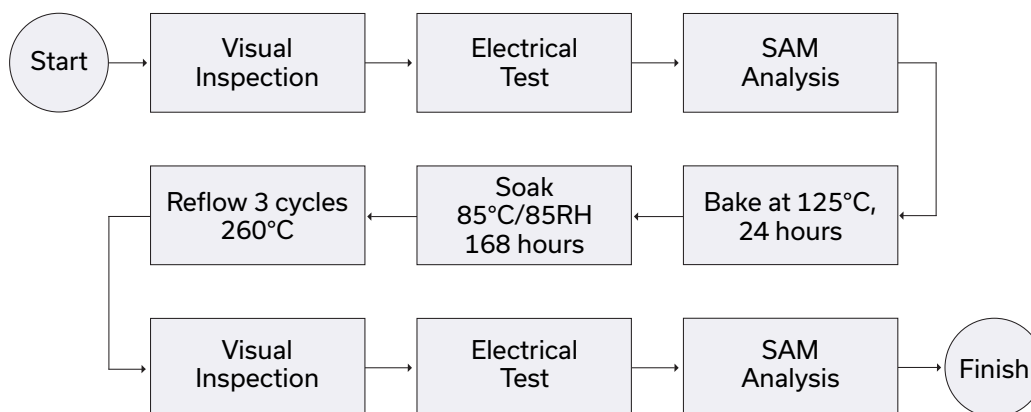

- NOTES**
- A. Performance and quality attributes and conditions not expressly stated in this specification document are intended to be excluded and do not form a part of this specification document.
 - B. Electrical specifications and performance data contained in this specification document are based on Mini-Circuit's applicable established test performance criteria and measurement instructions.
 - C. The parts covered by this specification document are subject to Mini-Circuits standard limited warranty and terms and conditions (collectively, "Standard Terms"); Purchasers of this part are entitled to the rights and benefits contained therein. For a full statement of the standard. Terms and the exclusive rights and remedies thereunder, please visit Mini-Circuits' website at www.minicircuits.com/MCLStore/terms.jsp



Typical Performance Data

NOTE: Use PDF Bookmarks to view DATA at required conditions

Definitions:

Input Return Loss = -S11 (dB)

Gain(Power Gain) = S21 (dB)

Reverse Isolation = -S12 (dB)

Output Return Loss = -S22 (dB)

TEST CONDITIONS: Vd = 5.00V, Id = 149.45mA @ Temperature = +25degC

FREQ	Gain	Isolation	Input Return Loss	Output Return Loss	Stability		IP-3 Output	1dB Comp. Output	Noise Figure
					K	Measure			
(MHz)	(dB)	(dB)	(dB)	(dB)	K	Measure	(dBm)	(dBm)	(dB)
50.0	17.64	21.54	11.78	14.27	0.99	0.67	43.17	22.70	1.72
200.0	16.30	20.67	19.6	20.97	1.10	0.65	40.80	22.64	1.77
400.0	16.07	20.58	20.1	21.81	1.12	0.66	40.67	22.56	1.81
600.0	15.86	20.53	18.93	21.40	1.12	0.67	40.61	22.76	1.81
800.0	15.62	20.43	17.42	20.85	1.13	0.69	40.58	22.83	1.92
1000.0	15.34	20.32	16.32	19.99	1.13	0.71	41.00	22.92	1.95
1200.0	15.03	20.18	15.09	19.41	1.13	0.73	40.34	22.67	2.00
1400.0	14.71	20.04	14.26	18.61	1.13	0.74	40.48	22.70	2.05
1600.0	14.36	19.87	13.46	18.05	1.14	0.76	40.72	22.69	2.15
1800.0	14.01	19.74	12.91	17.56	1.14	0.78	40.94	22.48	2.16
2000.0	13.67	19.53	12.42	16.93	1.14	0.80	41.72	22.66	2.21
2200.0	13.36	19.38	12.09	16.43	1.14	0.81	40.58	22.47	2.24
2400.0	13.04	19.16	11.67	16.00	1.14	0.82	41.82	22.56	2.31
2600.0	12.74	18.96	11.5	15.53	1.14	0.83	42.20	22.80	2.36
2800.0	12.45	18.76	11.23	15.03	1.14	0.84	40.98	22.62	2.53
3000.0	12.17	18.56	11.09	14.64	1.13	0.85	41.76	22.66	2.42
3200.0	11.92	18.37	11.08	14.14	1.13	0.85	41.29	22.66	2.53
3400.0	11.70	18.17	10.93	13.88	1.12	0.85	41.59	22.87	2.57
3600.0	11.46	17.96	10.88	13.51	1.12	0.85	40.89	22.89	2.59
3800.0	11.27	17.70	10.68	13.16	1.10	0.85	40.97	22.91	2.75
4000.0	11.13	17.52	10.62	12.91	1.09	0.85	40.33	22.66	2.77
4200.0	10.92	17.26	10.39	12.66	1.08	0.85	40.42	22.61	2.82
4400.0	10.81	17.08	10.31	12.43	1.07	0.85	40.60	22.78	2.86
4600.0	10.67	16.80	10.05	12.16	1.04	0.85	40.35	22.63	3.00
4800.0	10.53	16.56	9.87	12.07	1.03	0.85	39.97	22.50	3.04
5000.0	10.43	16.39	9.83	12.05	1.02	0.84	40.74	22.89	3.12
5200.0	10.38	16.18	9.6	11.72	1.00	0.84	39.87	22.41	3.19
5400.0	10.24	15.91	9.49	11.76	0.99	0.83	39.25	22.04	3.26
5600.0	10.24	15.66	9.38	11.40	0.97	0.82	39.67	22.01	3.41
5800.0	10.17	15.41	9.05	11.03	0.95	0.81	40.32	22.10	3.51
6000.0	10.08	15.13	8.69	10.96	0.93	0.80	39.86	22.33	3.63
6200.0	9.99	14.97	8.27	10.49	0.91	0.79	38.60	22.03	3.72
6400.0	9.91	14.75	7.88	10.19	0.90	0.78	38.48	21.53	3.93
6600.0	9.74	14.58	7.2	9.96	0.89	0.78	39.67	21.38	4.03
6800.0	9.47	14.42	6.59	9.56	0.88	0.78	39.03	21.58	4.23
7000.0	9.16	14.49	5.8	8.99	0.88	0.79	38.32	21.46	4.53
7200.0	8.69	14.62	5.03	8.31	0.88	0.81	37.45	21.16	4.76
7400.0	8.01	14.56	4.61	7.79	0.91	0.81	37.10	20.75	5.05
7600.0	7.32	14.80	4.09	6.93	0.92	0.82	38.04	20.39	5.33
7800.0	6.56	14.95	3.61	6.41	0.93	0.84	36.97	19.92	5.62
8000.0	5.71	15.15	3.43	5.82	0.97	0.82	36.10	18.87	6.05

Typical Performance Data

Definitions:

Input Return Loss = -S11 (dB)

Gain(Power Gain) = S21 (dB)

Reverse Isolation = -S12 (dB)

Output Return Loss = -S22 (dB)

TEST CONDITIONS: Vd = 4.75V, Id = 134.01mA @ Temperature = +25degC

FREQ	Gain	Isolation	Input Return Loss	Output Return Loss	Stability		IP-3 Output	1dB Comp. Output	Noise Figure
					K	Measure			
(MHz)	(dB)	(dB)	(dB)	(dB)	K	Measure	(dBm)	(dBm)	(dB)
50.0	17.58	21.21	11.61	14.44	0.97	0.65	41.60	22.13	1.73
200.0	16.25	20.63	19.41	21.25	1.11	0.65	42.89	22.09	1.73
400.0	16.03	20.58	19.92	22.16	1.12	0.66	41.61	22.01	1.79
600.0	15.82	20.49	18.83	21.73	1.12	0.67	41.55	22.21	1.84
800.0	15.58	20.41	17.36	21.11	1.13	0.69	41.02	22.29	1.92
1000.0	15.30	20.30	16.26	20.17	1.13	0.71	41.66	22.38	1.94
1200.0	14.99	20.18	15.04	19.55	1.13	0.73	40.64	22.14	2.01
1400.0	14.66	20.03	14.21	18.71	1.14	0.75	40.39	22.18	2.05
1600.0	14.32	19.87	13.42	18.10	1.14	0.77	40.13	22.18	2.16
1800.0	13.97	19.71	12.88	17.60	1.14	0.79	39.68	21.97	2.17
2000.0	13.63	19.52	12.38	16.91	1.14	0.80	39.76	22.15	2.17
2200.0	13.31	19.35	12.03	16.39	1.14	0.82	39.15	21.96	2.18
2400.0	13.00	19.14	11.61	15.96	1.14	0.83	39.26	22.04	2.30
2600.0	12.70	18.96	11.46	15.49	1.14	0.84	39.82	22.29	2.34
2800.0	12.41	18.76	11.19	14.95	1.13	0.84	39.11	22.11	2.49
3000.0	12.13	18.56	11.06	14.56	1.13	0.85	39.46	22.14	2.42
3200.0	11.88	18.38	11.04	14.07	1.13	0.85	38.70	22.15	2.48
3400.0	11.66	18.11	10.90	13.81	1.12	0.85	39.12	22.35	2.53
3600.0	11.42	17.98	10.83	13.44	1.12	0.86	38.37	22.35	2.59
3800.0	11.23	17.70	10.64	13.06	1.10	0.86	38.57	22.36	2.70
4000.0	11.09	17.52	10.56	12.80	1.09	0.85	38.35	22.13	2.72
4200.0	10.88	17.29	10.35	12.58	1.08	0.86	38.08	22.06	2.84
4400.0	10.77	17.10	10.25	12.35	1.07	0.86	38.21	22.21	2.81
4600.0	10.63	16.81	10.00	12.06	1.04	0.85	38.01	22.07	2.94
4800.0	10.49	16.59	9.83	11.96	1.03	0.85	37.56	21.93	2.98
5000.0	10.40	16.39	9.79	11.94	1.02	0.85	38.50	22.32	3.10
5200.0	10.33	16.17	9.56	11.61	1.00	0.84	37.69	21.84	3.20
5400.0	10.24	15.91	9.51	11.66	0.99	0.83	36.96	21.53	3.22
5600.0	10.18	15.69	9.29	11.28	0.97	0.83	37.53	21.47	3.36
5800.0	10.14	15.41	9.02	10.94	0.94	0.81	38.13	21.59	3.40
6000.0	10.03	15.13	8.65	10.85	0.93	0.81	37.71	21.79	3.54
6200.0	9.95	14.96	8.25	10.41	0.91	0.80	36.60	21.51	3.67
6400.0	9.86	14.73	7.83	10.12	0.89	0.79	36.41	21.01	3.83
6600.0	9.69	14.58	7.16	9.89	0.88	0.79	36.75	20.87	4.00
6800.0	9.43	14.46	6.54	9.48	0.88	0.79	36.55	21.05	4.12
7000.0	9.11	14.50	5.74	8.95	0.88	0.80	35.75	20.97	4.46
7200.0	8.63	14.66	5.04	8.30	0.89	0.82	35.06	20.65	4.67
7400.0	7.94	14.57	4.62	7.79	0.91	0.82	34.83	20.35	4.98
7600.0	7.25	14.82	4.10	6.97	0.92	0.83	35.22	20.14	5.24
7800.0	6.50	14.94	3.58	6.41	0.92	0.84	34.83	19.70	5.56
8000.0	5.64	15.20	3.45	5.84	0.97	0.83	33.78	18.67	5.92

Typical Performance Data

Definitions:

Input Return Loss = -S11 (dB)

Gain(Power Gain) = S21 (dB)

Reverse Isolation = -S12 (dB)

Output Return Loss = -S22 (dB)

TEST CONDITIONS: Vd = 5.25V, Id = 161.11mA @ Temperature = +25degC

FREQ	Gain	Isolation	Input Return Loss	Output Return Loss	Stability		IP-3 Output	1dB Comp. Output	Noise Figure
					K	Measure			
(MHz)	(dB)	(dB)	(dB)	(dB)	K	Measure	(dBm)	(dBm)	(dB)
50.0	17.69	21.27	11.70	14.39	0.97	0.64	42.76	23.23	1.83
200.0	16.38	20.72	19.59	21.31	1.10	0.65	40.26	23.10	1.78
400.0	16.15	20.65	20.09	22.32	1.12	0.66	39.67	23.02	1.83
600.0	15.95	20.58	18.99	21.93	1.12	0.67	39.80	23.21	1.86
800.0	15.71	20.49	17.51	21.47	1.13	0.69	39.71	23.28	1.94
1000.0	15.43	20.39	16.41	20.62	1.13	0.71	40.48	23.37	1.97
1200.0	15.12	20.28	15.19	20.06	1.13	0.73	40.37	23.10	2.06
1400.0	14.80	20.15	14.36	19.24	1.14	0.75	40.77	23.13	2.12
1600.0	14.46	19.98	13.55	18.68	1.14	0.77	41.43	23.12	2.21
1800.0	14.11	19.88	12.99	18.21	1.15	0.79	41.73	22.89	2.21
2000.0	13.78	19.68	12.49	17.50	1.15	0.80	41.97	23.08	2.25
2200.0	13.46	19.50	12.15	16.97	1.15	0.82	42.55	22.89	2.26
2400.0	13.15	19.29	11.72	16.49	1.14	0.83	42.22	22.97	2.33
2600.0	12.85	19.10	11.55	16.00	1.14	0.84	44.18	23.25	2.42
2800.0	12.56	18.92	11.29	15.43	1.14	0.85	43.92	23.03	2.60
3000.0	12.29	18.72	11.14	15.02	1.14	0.85	45.16	23.08	2.52
3200.0	12.03	18.52	11.13	14.50	1.14	0.85	45.75	23.07	2.52
3400.0	11.82	18.32	10.96	14.16	1.13	0.86	44.51	23.31	2.59
3600.0	11.57	18.14	10.89	13.78	1.13	0.86	45.47	23.30	2.69
3800.0	11.38	17.86	10.70	13.38	1.11	0.86	47.31	23.33	2.78
4000.0	11.25	17.69	10.62	13.10	1.10	0.86	45.01	23.07	2.78
4200.0	11.03	17.40	10.39	12.83	1.08	0.86	45.20	23.04	2.88
4400.0	10.93	17.24	10.29	12.59	1.07	0.86	45.27	23.23	2.92
4600.0	10.79	16.96	10.03	12.30	1.04	0.86	45.51	23.09	3.06
4800.0	10.65	16.73	9.84	12.17	1.03	0.85	47.90	22.96	3.12
5000.0	10.57	16.55	9.78	12.10	1.02	0.85	46.77	23.37	3.21
5200.0	10.51	16.31	9.56	11.79	1.00	0.85	46.38	22.84	3.29
5400.0	10.38	16.04	9.46	11.87	0.99	0.84	43.81	22.48	3.36
5600.0	10.35	15.82	9.31	11.42	0.97	0.83	46.11	22.41	3.52
5800.0	10.30	15.55	8.99	11.09	0.94	0.82	51.85	22.54	3.57
6000.0	10.23	15.22	8.67	11.05	0.92	0.80	44.45	22.76	3.69
6200.0	10.12	15.06	8.21	10.60	0.90	0.80	44.26	22.46	3.81
6400.0	10.04	14.85	7.82	10.31	0.89	0.79	46.10	21.88	4.03
6600.0	9.88	14.67	7.15	10.11	0.88	0.79	51.02	21.78	4.11
6800.0	9.62	14.51	6.53	9.72	0.87	0.79	46.59	21.99	4.37
7000.0	9.29	14.56	5.79	9.17	0.87	0.80	46.04	21.90	4.63
7200.0	8.83	14.73	5.00	8.55	0.88	0.83	45.74	21.46	4.83
7400.0	8.12	14.62	4.61	7.97	0.90	0.83	44.14	20.99	5.19
7600.0	7.44	14.92	4.06	7.16	0.91	0.84	46.80	20.61	5.48
7800.0	6.69	14.98	3.58	6.56	0.92	0.85	44.11	20.15	5.74
8000.0	5.82	15.31	3.43	6.00	0.98	0.84	41.54	19.05	6.18

Typical Performance Data

Definitions:

Input Return Loss = -S11 (dB)

Gain(Power Gain) = S21 (dB)

Reverse Isolation = -S12 (dB)

Output Return Loss = -S22 (dB)

TEST CONDITIONS: Vd = 5.00V, Id = 145.38mA @ Temperature = -45degC

FREQ	Gain	Isolation	Input Return Loss	Output Return Loss	Stability		IP-3 Output	1dB Comp. Output	Noise Figure
					K	Measure			
(MHz)	(dB)	(dB)	(dB)	(dB)	K	Measure	(dBm)	(dBm)	(dB)
50.0	17.39	20.84	12.04	13.58	0.95	0.63	41.00	22.69	1.62
200.0	15.76	20.11	20.06	18.45	1.10	0.63	38.23	22.69	1.53
400.0	15.53	20.06	21.09	18.69	1.12	0.64	38.06	22.63	1.55
600.0	15.36	19.98	19.98	18.64	1.13	0.65	38.05	22.83	1.57
800.0	15.17	19.92	18.56	18.61	1.13	0.66	38.04	22.94	1.63
1000.0	14.94	19.86	17.46	18.30	1.14	0.68	38.48	22.99	1.63
1200.0	14.69	19.74	16.16	18.16	1.14	0.69	38.08	22.79	1.67
1400.0	14.43	19.63	15.25	17.80	1.14	0.71	38.25	22.85	1.74
1600.0	14.14	19.49	14.43	17.64	1.15	0.73	38.67	22.83	1.80
1800.0	13.86	19.38	13.81	17.43	1.15	0.74	38.97	22.62	1.77
2000.0	13.56	19.25	13.36	17.07	1.15	0.76	39.05	22.80	1.84
2200.0	13.29	19.06	12.98	16.91	1.15	0.77	38.64	22.62	1.80
2400.0	13.02	18.89	12.54	16.70	1.15	0.78	39.00	22.68	1.90
2600.0	12.77	18.72	12.38	16.38	1.15	0.79	40.15	22.91	1.96
2800.0	12.52	18.51	12.07	15.86	1.14	0.80	39.57	22.76	2.08
3000.0	12.27	18.34	11.87	15.61	1.14	0.81	39.90	22.79	2.02
3200.0	12.05	18.20	11.93	15.26	1.14	0.81	39.80	22.81	1.98
3400.0	11.87	17.99	11.74	15.04	1.13	0.82	40.32	23.02	2.03
3600.0	11.67	17.80	11.54	14.59	1.12	0.82	40.41	23.05	2.05
3800.0	11.50	17.54	11.43	14.15	1.11	0.82	40.52	23.07	2.16
4000.0	11.37	17.33	11.28	13.88	1.10	0.81	39.59	22.85	2.16
4200.0	11.16	17.16	11.12	13.73	1.09	0.82	39.95	22.81	2.24
4400.0	11.08	16.96	10.88	13.43	1.07	0.82	40.26	22.99	2.29
4600.0	10.96	16.71	10.59	13.17	1.06	0.81	39.97	22.88	2.38
4800.0	10.84	16.48	10.40	12.89	1.04	0.81	39.82	22.76	2.42
5000.0	10.74	16.26	10.16	12.80	1.02	0.81	40.82	23.17	2.50
5200.0	10.71	16.12	9.97	12.55	1.01	0.81	39.56	22.68	2.52
5400.0	10.65	15.88	9.92	12.39	0.99	0.80	39.01	22.36	2.56
5600.0	10.59	15.63	9.74	11.83	0.97	0.78	39.38	22.21	2.71
5800.0	10.55	15.37	9.44	11.60	0.95	0.77	40.43	22.24	2.74
6000.0	10.51	15.09	9.14	11.47	0.93	0.76	40.39	22.50	2.86
6200.0	10.45	14.85	8.66	11.03	0.91	0.74	39.03	22.28	2.92
6400.0	10.46	14.63	8.33	10.86	0.90	0.73	38.19	21.78	3.08
6600.0	10.33	14.43	7.58	10.46	0.88	0.72	38.78	21.55	3.16
6800.0	10.24	14.20	6.87	10.08	0.88	0.69	39.12	21.78	3.35
7000.0	9.94	14.17	6.04	9.31	0.87	0.70	38.31	21.75	3.62
7200.0	9.56	14.28	5.14	8.37	0.86	0.72	37.10	21.48	3.77
7400.0	9.00	14.35	4.50	7.60	0.86	0.72	36.69	21.20	4.06
7600.0	8.37	14.42	3.92	6.76	0.85	0.73	37.52	21.04	4.22
7800.0	7.74	15.04	3.23	5.93	0.86	0.74	36.63	20.79	4.59
8000.0	6.87	15.07	2.97	5.46	0.89	0.74	35.50	19.76	4.88

Typical Performance Data

Definitions:

Input Return Loss = -S11 (dB)

Gain(Power Gain) = S21 (dB)

Reverse Isolation = -S12 (dB)

Output Return Loss = -S22 (dB)

TEST CONDITIONS: Vd = 4.75V, Id= 128.27 mA @ Temperature = -45degC

FREQ	Gain	Isolation	Input Return Loss	Output Return Loss	Stability		IP-3 Output	1dB Comp. Output	Noise Figure
					K	Measure			
(MHz)	(dB)	(dB)	(dB)	(dB)	K	Measure	(dBm)	(dBm)	(dB)
50.0	17.33	21.21	11.92	13.70	0.97	0.67	40.31	22.03	1.66
200.0	15.74	20.09	20.12	18.86	1.10	0.64	38.70	22.03	1.49
400.0	15.51	20.02	21.21	19.16	1.12	0.64	38.33	21.99	1.55
600.0	15.34	19.97	20.04	19.06	1.13	0.65	38.30	22.18	1.56
800.0	15.15	19.94	18.53	18.97	1.13	0.67	38.44	22.29	1.61
1000.0	14.92	19.80	17.40	18.59	1.13	0.68	39.18	22.33	1.65
1200.0	14.67	19.72	16.09	18.40	1.14	0.70	38.23	22.17	1.68
1400.0	14.40	19.61	15.17	17.95	1.14	0.71	38.31	22.21	1.72
1600.0	14.11	19.50	14.34	17.73	1.15	0.73	38.68	22.21	1.81
1800.0	13.82	19.34	13.71	17.49	1.15	0.75	38.53	22.02	1.81
2000.0	13.52	19.21	13.26	17.02	1.15	0.76	38.67	22.18	1.82
2200.0	13.25	19.04	12.87	16.80	1.15	0.78	37.99	22.03	1.84
2400.0	12.98	18.84	12.44	16.61	1.15	0.79	38.59	22.12	1.87
2600.0	12.72	18.69	12.25	16.23	1.15	0.80	39.52	22.31	1.96
2800.0	12.47	18.49	11.95	15.68	1.14	0.81	38.71	22.17	2.05
3000.0	12.22	18.30	11.77	15.42	1.14	0.81	39.31	22.20	2.00
3200.0	12.00	18.17	11.83	15.05	1.14	0.82	38.59	22.23	1.99
3400.0	11.81	17.94	11.63	14.83	1.13	0.82	38.80	22.44	1.99
3600.0	11.62	17.76	11.41	14.39	1.12	0.82	38.46	22.43	2.11
3800.0	11.44	17.51	11.31	13.96	1.11	0.82	38.58	22.47	2.09
4000.0	11.31	17.33	11.17	13.69	1.09	0.82	37.86	22.28	2.16
4200.0	11.11	17.12	11.00	13.56	1.09	0.82	37.68	22.23	2.21
4400.0	11.03	16.91	10.77	13.26	1.07	0.82	37.79	22.38	2.26
4600.0	10.90	16.67	10.48	12.98	1.05	0.82	37.61	22.29	2.30
4800.0	10.78	16.47	10.29	12.71	1.04	0.82	37.46	22.20	2.37
5000.0	10.68	16.25	10.07	12.66	1.02	0.81	38.65	22.53	2.46
5200.0	10.65	16.09	9.88	12.40	1.01	0.81	37.10	22.09	2.56
5400.0	10.59	15.85	9.82	12.23	0.99	0.80	36.72	21.80	2.55
5600.0	10.53	15.60	9.64	11.71	0.97	0.79	37.04	21.66	2.65
5800.0	10.48	15.35	9.34	11.48	0.95	0.77	37.68	21.69	2.70
6000.0	10.44	15.06	9.05	11.37	0.93	0.76	37.23	21.97	2.80
6200.0	10.38	14.81	8.59	10.92	0.91	0.75	36.36	21.77	2.85
6400.0	10.38	14.58	8.24	10.76	0.89	0.73	36.01	21.27	3.05
6600.0	10.26	14.41	7.50	10.35	0.88	0.73	36.20	21.03	3.15
6800.0	10.15	14.18	6.80	9.96	0.87	0.70	36.16	21.27	3.32
7000.0	9.86	14.17	5.98	9.23	0.86	0.71	35.66	21.27	3.49
7200.0	9.46	14.30	5.10	8.29	0.85	0.73	35.06	20.96	3.70
7400.0	8.90	14.34	4.47	7.55	0.86	0.73	34.54	20.67	3.95
7600.0	8.27	14.46	3.90	6.73	0.85	0.74	34.91	20.58	4.25
7800.0	7.64	15.01	3.22	5.91	0.86	0.75	34.60	20.51	4.50
8000.0	6.76	15.07	2.97	5.45	0.88	0.75	33.68	19.53	4.87

Typical Performance Data

Definitions:

Input Return Loss = -S11 (dB)

Gain(Power Gain) = S21 (dB)

Reverse Isolation = -S12 (dB)

Output Return Loss = -S22 (dB)

TEST CONDITIONS: Vd = 5.25V, Id = 157.3mA @ Temperature = -45degC

FREQ	Gain	Isolation	Input Return Loss	Output Return Loss	Stability		IP-3 Output	1dB Comp. Output	Noise Figure
					K	Measure			
(MHz)	(dB)	(dB)	(dB)	(dB)	K	Measure	(dBm)	(dBm)	(dB)
50.0	17.45	21.00	12.09	13.66	0.96	0.64	42.02	23.20	1.65
200.0	15.86	20.21	20.14	18.65	1.10	0.64	37.84	23.25	1.51
400.0	15.63	20.14	21.21	18.92	1.12	0.64	37.51	23.18	1.55
600.0	15.47	20.08	20.05	18.83	1.13	0.65	37.83	23.37	1.56
800.0	15.27	20.03	18.57	18.80	1.13	0.67	37.79	23.46	1.63
1000.0	15.04	19.91	17.44	18.47	1.13	0.68	38.42	23.53	1.63
1200.0	14.79	19.84	16.15	18.33	1.14	0.70	38.07	23.32	1.71
1400.0	14.52	19.71	15.23	17.97	1.14	0.71	38.05	23.37	1.78
1600.0	14.23	19.58	14.39	17.79	1.15	0.73	38.66	23.34	1.85
1800.0	13.94	19.45	13.76	17.61	1.15	0.75	38.57	23.12	1.82
2000.0	13.64	19.30	13.33	17.17	1.15	0.76	39.22	23.30	1.84
2200.0	13.37	19.14	12.94	17.04	1.15	0.77	39.08	23.11	1.83
2400.0	13.10	18.99	12.52	16.83	1.15	0.79	39.29	23.18	1.95
2600.0	12.84	18.76	12.33	16.47	1.15	0.79	40.27	23.43	2.00
2800.0	12.58	18.58	12.02	15.92	1.14	0.80	39.90	23.26	2.10
3000.0	12.34	18.41	11.84	15.67	1.14	0.81	40.75	23.29	2.03
3200.0	12.11	18.22	11.93	15.25	1.14	0.81	40.18	23.29	2.04
3400.0	11.93	18.01	11.72	15.05	1.13	0.82	41.23	23.53	2.08
3600.0	11.73	17.80	11.51	14.58	1.12	0.82	41.32	23.54	2.13
3800.0	11.56	17.56	11.40	14.15	1.11	0.81	41.63	23.57	2.20
4000.0	11.42	17.38	11.25	13.91	1.10	0.82	40.75	23.32	2.21
4200.0	11.22	17.20	11.08	13.74	1.09	0.82	41.81	23.31	2.30
4400.0	11.14	17.00	10.88	13.46	1.07	0.82	41.78	23.49	2.33
4600.0	11.01	16.74	10.57	13.19	1.05	0.81	42.10	23.37	2.43
4800.0	10.89	16.51	10.38	12.87	1.04	0.81	41.42	23.26	2.48
5000.0	10.79	16.32	10.14	12.84	1.02	0.81	43.56	23.63	2.55
5200.0	10.77	16.15	9.96	12.57	1.01	0.81	42.31	23.14	2.61
5400.0	10.70	15.90	9.91	12.33	0.99	0.79	41.21	22.84	2.62
5600.0	10.64	15.62	9.71	11.84	0.97	0.78	42.06	22.68	2.76
5800.0	10.60	15.40	9.42	11.61	0.95	0.77	43.71	22.70	2.81
6000.0	10.56	15.10	9.12	11.53	0.93	0.75	43.79	22.97	2.91
6200.0	10.50	14.86	8.64	11.05	0.91	0.74	41.34	22.76	2.97
6400.0	10.51	14.60	8.31	10.88	0.89	0.72	41.08	22.20	3.16
6600.0	10.39	14.41	7.56	10.52	0.88	0.72	41.67	21.98	3.22
6800.0	10.28	14.24	6.84	10.04	0.87	0.70	42.16	22.21	3.44
7000.0	9.99	14.19	6.01	9.35	0.86	0.70	41.38	22.20	3.69
7200.0	9.60	14.34	5.11	8.35	0.85	0.72	40.16	21.90	3.85
7400.0	9.04	14.31	4.47	7.61	0.85	0.72	39.71	21.61	4.14
7600.0	8.41	14.45	3.90	6.83	0.85	0.74	39.94	21.30	4.37
7800.0	7.78	14.92	3.21	5.96	0.85	0.74	39.42	21.01	4.69
8000.0	6.90	15.09	2.96	5.48	0.88	0.75	37.91	19.92	5.06

Typical Performance Data

Definitions:

Input Return Loss = -S11 (dB)

Gain(Power Gain) = S21 (dB)

Reverse Isolation = -S12 (dB)

Output Return Loss = -S22 (dB)

TEST CONDITIONS: Vd = 5.00V, Id = 139.6mA @ Temperature = +85degC

FREQ	Gain	Isolation	Input Return Loss	Output Return Loss	Stability		IP-3 Output	1dB Comp. Output	Noise Figure
					K	Measure			
(MHz)	(dB)	(dB)	(dB)	(dB)	K	Measure	(dBm)	(dBm)	(dB)
50.0	17.77	21.94	11.35	14.63	1.01	0.69	43.75	22.68	2.14
200.0	16.64	21.04	17.86	23.23	1.11	0.66	42.54	22.50	2.09
400.0	16.41	20.98	17.64	25.23	1.12	0.67	42.35	22.42	1.91
600.0	16.18	20.92	17.04	23.77	1.12	0.69	42.40	22.62	2.05
800.0	15.90	20.82	15.78	22.66	1.12	0.71	42.53	22.67	2.14
1000.0	15.59	20.68	14.96	21.29	1.13	0.73	43.46	22.78	2.26
1200.0	15.24	20.53	13.98	20.22	1.13	0.75	42.75	22.52	2.30
1400.0	14.89	20.35	13.31	19.15	1.13	0.77	43.63	22.57	2.31
1600.0	14.51	20.20	12.62	18.31	1.13	0.80	44.49	22.57	2.51
1800.0	14.14	19.98	12.15	17.50	1.13	0.81	44.54	22.38	2.40
2000.0	13.76	19.84	11.73	16.81	1.13	0.83	45.06	22.57	2.48
2200.0	13.42	19.66	11.43	16.10	1.14	0.84	44.11	22.35	2.52
2400.0	13.07	19.44	11.08	15.63	1.13	0.86	44.90	22.46	2.62
2600.0	12.75	19.27	10.92	15.15	1.14	0.87	46.75	22.71	2.79
2800.0	12.45	19.01	10.62	14.56	1.12	0.87	45.45	22.48	2.83
3000.0	12.15	18.81	10.47	14.13	1.12	0.88	46.23	22.55	2.92
3200.0	11.85	18.63	10.50	13.67	1.13	0.88	45.33	22.51	3.05
3400.0	11.63	18.43	10.35	13.29	1.12	0.89	45.55	22.72	3.16
3600.0	11.38	18.25	10.30	12.98	1.12	0.89	46.13	22.70	3.13
3800.0	11.17	18.01	10.13	12.61	1.10	0.89	45.81	22.70	2.97
4000.0	11.00	17.76	9.96	12.22	1.08	0.89	46.26	22.42	3.18
4200.0	10.77	17.57	9.94	12.16	1.08	0.89	45.36	22.35	3.27
4400.0	10.65	17.38	9.83	11.92	1.07	0.89	46.92	22.50	3.38
4600.0	10.50	17.09	9.64	11.59	1.04	0.89	45.16	22.37	3.43
4800.0	10.38	16.88	9.49	11.48	1.03	0.88	45.26	22.23	3.61
5000.0	10.26	16.68	9.48	11.46	1.02	0.88	44.12	22.64	3.67
5200.0	10.23	16.44	9.23	11.11	0.99	0.88	44.13	22.15	3.87
5400.0	10.09	16.13	9.23	10.90	0.98	0.86	44.45	21.81	3.92
5600.0	10.03	15.89	9.00	10.75	0.96	0.86	43.05	21.84	3.92
5800.0	9.95	15.62	8.68	10.53	0.93	0.85	41.52	22.01	3.99
6000.0	9.88	15.32	8.44	10.52	0.92	0.84	41.51	22.13	4.23
6200.0	9.74	15.13	8.00	10.29	0.90	0.84	44.23	21.81	4.26
6400.0	9.59	14.95	7.63	10.03	0.89	0.84	41.94	21.33	4.61
6600.0	9.38	14.80	7.09	9.92	0.89	0.84	41.04	21.29	4.66
6800.0	9.05	14.69	6.43	9.72	0.89	0.86	41.10	21.44	5.14
7000.0	8.62	14.75	5.73	9.30	0.90	0.88	42.23	21.30	5.33
7200.0	8.12	15.00	5.03	8.69	0.92	0.90	42.12	20.78	5.59
7400.0	7.36	15.04	4.65	8.25	0.96	0.91	42.51	20.23	5.71
7600.0	6.63	15.24	4.07	7.49	0.97	0.93	42.07	19.86	6.17
7800.0	5.82	15.44	3.79	6.90	1.01	0.92	46.35	19.29	6.23
8000.0	4.96	15.75	3.52	6.27	1.06	0.91	44.82	18.26	6.81

Typical Performance Data

Definitions:

Input Return Loss = -S11 (dB)

Gain(Power Gain) = S21 (dB)

Reverse Isolation = -S12 (dB)

Output Return Loss = -S22 (dB)

TEST CONDITIONS: Vd = 4.75V, Id = 132.97mA @ Temperature = +85degC

FREQ	Gain	Isolation	Input Return Loss	Output Return Loss	Stability		IP-3 Output	1dB Comp. Output	Noise Figure
					K	Measure			
(MHz)	(dB)	(dB)	(dB)	(dB)	K	Measure	(dBm)	(dBm)	(dB)
50.0	17.73	21.46	11.32	14.59	0.99	0.65	42.03	22.15	2.09
200.0	16.61	21.01	17.59	23.30	1.11	0.66	43.70	21.98	2.05
400.0	16.37	20.94	17.39	25.23	1.12	0.67	44.00	21.90	2.05
600.0	16.14	20.89	16.81	23.65	1.12	0.69	44.30	22.11	2.13
800.0	15.86	20.78	15.61	22.52	1.12	0.71	44.00	22.17	2.23
1000.0	15.54	20.64	14.81	21.14	1.12	0.73	48.28	22.27	2.29
1200.0	15.20	20.51	13.84	20.03	1.13	0.76	45.74	22.02	2.35
1400.0	14.84	20.33	13.21	18.93	1.13	0.78	45.82	22.07	2.43
1600.0	14.46	20.15	12.53	18.08	1.13	0.80	46.71	22.08	2.50
1800.0	14.09	19.98	12.06	17.31	1.13	0.82	49.58	21.88	2.53
2000.0	13.71	19.80	11.65	16.61	1.13	0.83	50.14	22.07	2.59
2200.0	13.36	19.63	11.35	15.89	1.13	0.85	45.36	21.86	2.60
2400.0	13.02	19.41	11.01	15.43	1.13	0.86	48.39	21.97	2.73
2600.0	12.70	19.24	10.84	14.95	1.13	0.87	51.82	22.20	2.83
2800.0	12.39	18.98	10.55	14.36	1.12	0.88	50.72	21.98	2.96
3000.0	12.09	18.82	10.42	13.97	1.12	0.88	47.49	22.04	2.95
3200.0	11.77	18.60	10.48	13.50	1.13	0.88	47.71	22.01	2.97
3400.0	11.57	18.39	10.29	13.13	1.11	0.89	45.67	22.20	3.07
3600.0	11.32	18.25	10.23	12.84	1.12	0.89	44.42	22.19	3.12
3800.0	11.11	17.99	10.07	12.46	1.10	0.89	44.71	22.17	3.24
4000.0	10.93	17.74	9.91	12.09	1.08	0.89	45.71	21.92	3.27
4200.0	10.71	17.54	9.87	11.99	1.08	0.89	44.61	21.83	3.34
4400.0	10.58	17.34	9.76	11.77	1.06	0.89	43.83	21.98	3.41
4600.0	10.43	17.08	9.59	11.47	1.04	0.89	42.64	21.84	3.52
4800.0	10.31	16.85	9.45	11.36	1.03	0.89	42.23	21.70	3.55
5000.0	10.19	16.68	9.46	11.35	1.02	0.88	41.68	22.11	3.68
5200.0	10.16	16.41	9.19	10.96	0.99	0.88	42.68	21.64	3.84
5400.0	10.01	16.11	9.20	10.77	0.98	0.87	41.71	21.32	3.87
5600.0	9.95	15.87	8.97	10.64	0.95	0.86	42.83	21.35	4.00
5800.0	9.87	15.59	8.64	10.43	0.93	0.86	42.74	21.50	4.05
6000.0	9.82	15.29	8.45	10.41	0.92	0.84	41.77	21.63	4.24
6200.0	9.66	15.12	7.97	10.18	0.90	0.85	41.47	21.31	4.38
6400.0	9.51	14.96	7.62	9.94	0.89	0.85	43.55	20.84	4.61
6600.0	9.29	14.77	7.09	9.84	0.89	0.84	43.00	20.78	4.76
6800.0	8.95	14.71	6.44	9.66	0.89	0.86	43.12	20.95	4.96
7000.0	8.52	14.75	5.74	9.25	0.90	0.88	42.24	20.84	5.29
7200.0	8.02	15.01	5.00	8.63	0.92	0.90	42.01	20.48	5.57
7400.0	7.24	15.03	4.68	8.20	0.97	0.91	42.76	19.97	5.88
7600.0	6.51	15.25	4.10	7.46	0.98	0.93	43.10	19.63	6.17
7800.0	5.71	15.49	3.80	6.86	1.02	0.93	40.44	19.08	6.51
8000.0	4.85	15.72	3.54	6.25	1.07	0.91	38.63	18.08	6.93

Typical Performance Data

Definitions:

Input Return Loss = -S11 (dB)

Gain(Power Gain) = S21 (dB)

Reverse Isolation = -S12 (dB)

Output Return Loss = -S22 (dB)

TEST CONDITIONS: Vd = 5.25V, Id = 159.13mA @ Temperature = +85degC

FREQ	Gain	Isolation	Input Return Loss	Output Return Loss	Stability		IP-3 Output	1dB Comp. Output	Noise Figure
					K	Measure			
(MHz)	(dB)	(dB)	(dB)	(dB)	K	Measure	(dBm)	(dBm)	(dB)
50.0	17.83	21.65	11.35	14.76	0.99	0.66	43.15	23.13	2.24
200.0	16.72	21.13	17.70	23.47	1.11	0.66	41.90	22.94	2.09
400.0	16.49	21.05	17.45	25.56	1.12	0.67	41.90	22.85	2.17
600.0	16.26	20.99	16.89	24.11	1.12	0.69	41.82	23.06	2.19
800.0	15.98	20.85	15.68	23.02	1.12	0.71	41.89	23.10	2.27
1000.0	15.67	20.77	14.87	21.61	1.13	0.73	42.82	23.22	2.34
1200.0	15.32	20.64	13.91	20.49	1.13	0.76	41.95	22.96	2.41
1400.0	14.96	20.45	13.26	19.42	1.13	0.78	41.27	23.01	2.51
1600.0	14.58	20.31	12.58	18.55	1.13	0.80	43.03	23.04	2.56
1800.0	14.21	20.13	12.12	17.70	1.14	0.82	42.17	22.83	2.60
2000.0	13.84	19.96	11.70	17.04	1.14	0.84	41.54	23.03	2.67
2200.0	13.49	19.75	11.41	16.27	1.14	0.85	41.64	22.82	2.70
2400.0	13.15	19.59	11.05	15.78	1.14	0.86	41.57	22.91	2.84
2600.0	12.83	19.36	10.88	15.29	1.14	0.87	42.32	23.19	2.91
2800.0	12.52	19.11	10.57	14.68	1.13	0.88	41.71	22.94	3.08
3000.0	12.22	18.93	10.43	14.23	1.13	0.88	41.59	23.00	3.06
3200.0	11.91	18.79	10.48	13.84	1.14	0.89	40.79	22.94	3.05
3400.0	11.70	18.52	10.29	13.36	1.12	0.89	41.03	23.16	3.12
3600.0	11.46	18.34	10.19	13.02	1.11	0.89	41.62	23.16	3.19
3800.0	11.24	18.10	10.05	12.66	1.10	0.89	41.71	23.16	3.32
4000.0	11.06	17.85	9.89	12.27	1.08	0.89	41.17	22.88	3.39
4200.0	10.84	17.66	9.86	12.14	1.08	0.89	41.34	22.79	3.49
4400.0	10.71	17.49	9.73	11.93	1.07	0.89	41.28	22.99	3.55
4600.0	10.56	17.20	9.55	11.59	1.04	0.89	40.59	22.85	3.68
4800.0	10.44	16.96	9.42	11.45	1.02	0.89	40.18	22.70	3.76
5000.0	10.34	16.79	9.42	11.44	1.02	0.89	40.46	23.12	3.85
5200.0	10.29	16.51	9.14	11.03	0.98	0.88	40.20	22.61	3.97
5400.0	10.15	16.23	9.16	10.87	0.97	0.87	40.43	22.28	4.00
5600.0	10.08	15.95	8.90	10.71	0.95	0.86	39.30	22.33	4.17
5800.0	10.00	15.68	8.58	10.52	0.93	0.86	39.43	22.47	4.27
6000.0	9.96	15.38	8.39	10.52	0.91	0.85	39.02	22.60	4.45
6200.0	9.80	15.20	7.92	10.30	0.90	0.85	39.41	22.26	4.59
6400.0	9.65	15.03	7.56	10.07	0.88	0.85	38.23	21.81	4.81
6600.0	9.44	14.84	7.00	10.00	0.88	0.85	37.65	21.76	5.00
6800.0	9.09	14.74	6.37	9.84	0.89	0.87	37.86	21.90	5.19
7000.0	8.66	14.80	5.67	9.44	0.89	0.89	37.87	21.55	5.55
7200.0	8.15	15.04	4.96	8.84	0.91	0.91	37.38	21.02	5.83
7400.0	7.39	15.04	4.61	8.38	0.95	0.92	37.48	20.43	6.16
7600.0	6.65	15.29	4.04	7.64	0.97	0.94	37.20	20.05	6.42
7800.0	5.85	15.47	3.76	7.02	1.01	0.94	37.91	19.47	6.76
8000.0	4.97	15.78	3.50	6.39	1.07	0.93	36.72	18.40	7.18

Typical Performance Data

Definitions:

Input Return Loss = -S11 (dB)

Gain(Power Gain) = S21 (dB)

Reverse Isolation = -S12 (dB)

Output Return Loss = -S22 (dB)

TEST CONDITIONS: Vd = 4.00V, Id = 91.22mA @ Temperature = +25degC

FREQ	Gain	Isolation	Input Return Loss	Output Return Loss	Stability		IP-3 Output	1dB Comp. Output	Noise Figure
					K	Measure			
(MHz)	(dB)	(dB)	(dB)	(dB)	K	Measure	(dBm)	(dBm)	(dB)
50.0	17.47	21.41	11.06	13.57	0.97	0.68	36.53	19.99	1.59
100.0	16.43	20.70	15.72	17.53	1.07	0.66	38.51	19.86	1.68
150.0	16.15	20.55	18.19	19.17	1.10	0.66	38.11	20.02	1.77
200.0	16.03	20.47	19.48	19.92	1.11	0.65	40.98	19.99	1.76
250.0	15.95	20.40	20.18	20.26	1.11	0.65	43.98	19.91	1.77
300.0	15.89	20.44	20.51	20.41	1.12	0.66	42.20	20.12	1.79
350.0	15.84	20.38	20.49	20.45	1.12	0.66	39.63	20.09	1.79
400.0	15.78	20.37	20.46	20.44	1.12	0.66	40.35	20.04	1.81
450.0	15.73	20.37	20.28	20.32	1.12	0.66	39.70	20.07	1.81
500.0	15.68	20.31	20.03	20.28	1.12	0.66	38.39	20.20	1.80
550.0	15.64	20.31	19.72	20.06	1.12	0.67	39.74	20.00	1.87
600.0	15.57	20.29	19.45	19.87	1.13	0.67	38.45	20.08	1.98
650.0	15.52	20.23	19.10	19.65	1.12	0.67	38.76	20.15	1.92
700.0	15.45	20.24	18.81	19.50	1.13	0.68	38.38	20.22	1.85
750.0	15.39	20.19	18.48	19.31	1.13	0.68	37.90	20.12	1.90
800.0	15.32	20.17	18.14	19.22	1.13	0.68	38.62	20.20	1.88
850.0	15.25	20.15	17.78	19.01	1.13	0.69	38.84	20.16	1.90
900.0	15.18	20.10	17.41	18.87	1.13	0.69	37.98	20.19	1.87
950.0	15.11	20.08	17.08	18.69	1.13	0.69	37.21	20.21	1.95
1000.0	15.03	20.02	16.71	18.53	1.13	0.70	36.84	20.19	1.92
1200.0	14.70	19.89	15.58	17.58	1.14	0.71	36.58	20.29	2.01
1400.0	14.36	19.74	14.56	16.95	1.14	0.73	36.75	20.23	2.05
1600.0	14.00	19.59	13.70	16.27	1.14	0.75	36.05	20.28	2.09
1800.0	13.63	19.40	12.98	15.67	1.15	0.77	35.77	20.12	2.09
2000.0	13.28	19.21	12.34	15.24	1.15	0.78	35.83	20.13	2.07
2200.0	12.91	19.07	11.94	14.87	1.15	0.80	35.29	20.27	2.09
2400.0	12.57	18.88	11.50	14.51	1.15	0.81	35.32	20.24	2.14
2600.0	12.21	18.75	11.28	14.24	1.17	0.83	35.01	20.22	2.37
2800.0	11.93	18.51	10.99	14.19	1.16	0.84	34.77	20.28	2.33
3000.0	11.63	18.31	10.70	13.88	1.16	0.84	34.37	20.18	2.30
3500.0	10.97	17.84	10.32	13.59	1.16	0.86	34.11	20.21	2.54
4000.0	10.45	17.33	9.83	13.28	1.14	0.88	33.89	20.20	2.56
4500.0	9.98	16.93	9.55	13.11	1.13	0.89	33.51	20.12	2.84
5000.0	9.68	16.40	9.17	12.53	1.09	0.88	33.31	20.10	2.94
5500.0	9.51	15.94	8.87	11.82	1.04	0.88	32.26	19.59	3.05
6000.0	9.33	15.38	8.54	11.16	1.00	0.85	32.33	19.55	3.14

Typical Performance Data

Definitions:

Input Return Loss = -S11 (dB)

Gain(Power Gain) = S21 (dB)

Reverse Isolation = -S12 (dB)

Output Return Loss = -S22 (dB)

TEST CONDITIONS: Vd = 4.50V, Id = 117.53mA @ Temperature = +25degC

FREQ	Gain	Isolation	Input Return Loss	Output Return Loss	Stability		IP-3 Output	1dB Comp. Output	Noise Figure
					K	Measure			
(MHz)	(dB)	(dB)	(dB)	(dB)	K	Measure	(dBm)	(dBm)	(dB)
50.0	17.72	21.50	11.37	13.63	0.96	0.67	38.69	21.41	1.65
100.0	16.68	20.83	16.02	17.58	1.06	0.65	42.91	21.23	1.69
150.0	16.40	20.68	18.58	19.17	1.09	0.64	42.73	21.42	1.79
200.0	16.29	20.64	19.95	19.89	1.10	0.64	46.70	21.39	1.75
250.0	16.21	20.61	20.67	20.25	1.11	0.64	41.58	21.28	1.79
300.0	16.15	20.54	21.03	20.37	1.11	0.64	44.13	21.54	1.84
350.0	16.10	20.54	21.06	20.51	1.11	0.65	51.58	21.49	1.79
400.0	16.05	20.58	20.98	20.50	1.12	0.65	43.05	21.45	1.81
450.0	16.00	20.54	20.81	20.47	1.12	0.65	44.14	21.49	1.81
500.0	15.95	20.51	20.57	20.45	1.12	0.65	44.18	21.61	1.82
550.0	15.90	20.50	20.26	20.27	1.12	0.66	41.47	21.39	1.86
600.0	15.84	20.50	20.00	20.10	1.13	0.66	40.46	21.48	1.97
650.0	15.79	20.45	19.64	19.98	1.13	0.66	42.28	21.57	1.93
700.0	15.73	20.44	19.37	19.89	1.13	0.67	41.12	21.65	1.87
750.0	15.67	20.44	18.96	19.71	1.13	0.67	43.08	21.53	1.89
800.0	15.60	20.38	18.65	19.69	1.13	0.67	42.32	21.63	1.92
850.0	15.53	20.34	18.25	19.56	1.13	0.68	42.58	21.58	1.93
900.0	15.46	20.33	17.88	19.44	1.13	0.68	42.04	21.61	1.91
950.0	15.39	20.32	17.55	19.30	1.14	0.69	41.87	21.63	1.95
1000.0	15.31	20.27	17.18	19.17	1.14	0.69	40.96	21.61	1.97
1200.0	14.99	20.15	16.01	18.39	1.14	0.71	42.39	21.71	2.02
1400.0	14.65	20.01	14.97	17.87	1.15	0.73	40.66	21.64	2.00
1600.0	14.30	19.86	14.08	17.26	1.15	0.75	39.50	21.72	2.10
1800.0	13.95	19.69	13.37	16.72	1.16	0.76	39.46	21.48	2.08
2000.0	13.60	19.50	12.69	16.36	1.16	0.78	40.21	21.51	2.10
2200.0	13.23	19.37	12.30	15.99	1.17	0.80	38.17	21.72	2.15
2400.0	12.91	19.15	11.83	15.64	1.17	0.81	39.41	21.65	2.17
2600.0	12.55	19.08	11.61	15.42	1.18	0.83	38.42	21.62	2.37
2800.0	12.28	18.82	11.30	15.35	1.17	0.84	38.54	21.72	2.35
3000.0	11.98	18.61	10.99	15.02	1.17	0.85	38.17	21.55	2.34
3500.0	11.33	18.19	10.57	14.71	1.17	0.87	37.99	21.62	2.57
4000.0	10.81	17.66	10.03	14.29	1.15	0.88	37.93	21.65	2.60
4500.0	10.36	17.26	9.72	14.10	1.14	0.89	36.89	21.62	2.94
5000.0	10.06	16.72	9.29	13.42	1.10	0.89	37.22	21.63	3.00
5500.0	9.90	16.22	8.94	12.56	1.04	0.88	35.72	20.92	3.11
6000.0	9.74	15.63	8.57	11.85	0.99	0.86	36.23	20.86	3.28

Typical Performance Data

Definitions:

Input Return Loss = -S11 (dB)

Gain(Power Gain) = S21 (dB)

Reverse Isolation = -S12 (dB)

Output Return Loss = -S22 (dB)

TEST CONDITIONS: Vd = 4.00V, Id = 87.36mA @ Temperature = -40degC

FREQ	Gain	Isolation	Input Return Loss	Output Return Loss	Stability		IP-3 Output	1dB Comp. Output	Noise Figure
					K	Measure			
(MHz)	(dB)	(dB)	(dB)	(dB)	K	Measure	(dBm)	(dBm)	(dB)
50.0	17.25	20.72	11.33	13.11	0.94	0.64	35.16	19.63	1.37
100.0	16.02	20.18	15.88	16.12	1.05	0.65	37.14	19.59	1.45
150.0	15.66	20.00	18.45	17.36	1.09	0.64	37.37	19.72	1.51
200.0	15.52	19.93	19.89	17.90	1.10	0.64	39.95	19.70	1.50
250.0	15.44	19.91	20.75	18.12	1.11	0.64	39.77	19.67	1.54
300.0	15.38	19.87	21.16	18.19	1.12	0.64	40.79	19.80	1.52
350.0	15.33	19.83	21.18	18.16	1.12	0.64	40.46	19.79	1.54
400.0	15.28	19.85	21.03	18.12	1.12	0.64	41.90	19.73	1.58
450.0	15.24	19.84	20.86	18.02	1.13	0.64	39.85	19.76	1.57
500.0	15.20	19.81	20.63	18.02	1.13	0.64	40.60	19.88	1.58
550.0	15.16	19.79	20.38	18.02	1.13	0.65	38.50	19.76	1.66
600.0	15.11	19.77	20.17	18.00	1.13	0.65	38.74	19.82	1.67
650.0	15.07	19.75	19.99	18.01	1.13	0.65	38.14	19.84	1.62
700.0	15.02	19.75	19.76	17.97	1.13	0.65	37.52	19.91	1.60
750.0	14.97	19.74	19.49	17.83	1.13	0.66	37.51	19.86	1.61
800.0	14.92	19.72	19.18	17.75	1.14	0.66	36.91	19.90	1.63
850.0	14.86	19.71	18.73	17.57	1.14	0.66	37.20	19.88	1.68
900.0	14.80	19.68	18.30	17.45	1.14	0.67	37.11	19.92	1.60
950.0	14.74	19.67	17.90	17.33	1.14	0.67	35.84	19.88	1.65
1000.0	14.68	19.65	17.53	17.30	1.14	0.67	35.59	19.87	1.61
1200.0	14.42	19.55	16.57	16.97	1.15	0.69	35.59	19.99	1.73
1400.0	14.14	19.46	15.49	16.58	1.16	0.70	34.77	19.96	1.75
1600.0	13.84	19.37	14.59	16.34	1.16	0.72	34.38	20.00	1.76
1800.0	13.55	19.23	13.95	16.02	1.17	0.74	34.06	19.87	1.78
2000.0	13.26	19.08	13.21	15.91	1.17	0.75	33.83	19.91	1.78
2200.0	12.94	18.98	12.85	15.70	1.18	0.77	34.05	20.04	1.80
2400.0	12.66	18.80	12.34	15.53	1.18	0.78	33.09	20.07	1.80
2600.0	12.35	18.70	12.19	15.52	1.19	0.80	32.98	20.06	1.98
2800.0	12.11	18.51	11.77	15.53	1.18	0.81	32.97	20.13	1.97
3000.0	11.86	18.31	11.51	15.35	1.18	0.82	32.74	20.06	1.90
3500.0	11.30	17.95	11.12	15.21	1.18	0.84	32.07	20.10	2.07
4000.0	10.84	17.45	10.49	14.83	1.15	0.86	32.17	20.14	2.05
4500.0	10.44	17.09	10.01	14.55	1.14	0.87	31.90	20.08	2.28
5000.0	10.15	16.64	9.61	14.07	1.11	0.87	31.82	20.09	2.42
5500.0	10.04	16.17	9.30	13.04	1.05	0.86	30.96	19.62	2.50
6000.0	9.92	15.55	8.98	12.28	1.00	0.83	30.87	19.64	2.59

Typical Performance Data

Definitions:

Input Return Loss = -S11 (dB)

Gain(Power Gain) = S21 (dB)

Reverse Isolation = -S12 (dB)

Output Return Loss = -S22 (dB)

TEST CONDITIONS: Vd = 4.50V, Id = 113.55mA @ Temperature = -40degC

FREQ	Gain	Isolation	Input Return Loss	Output Return Loss	Stability		IP-3 Output	1dB Comp. Output	Noise Figure
					K	Measure			
(MHz)	(dB)	(dB)	(dB)	(dB)	K	Measure	(dBm)	(dBm)	(dB)
50.0	17.50	20.86	11.43	13.19	0.93	0.64	39.57	21.24	1.36
100.0	16.27	20.35	16.01	16.00	1.05	0.64	39.49	21.13	1.46
150.0	15.92	20.22	18.45	17.08	1.09	0.63	38.63	21.28	1.52
200.0	15.78	20.12	19.84	17.60	1.10	0.63	39.69	21.27	1.50
250.0	15.70	20.08	20.64	17.79	1.11	0.63	38.62	21.20	1.54
300.0	15.63	20.04	21.00	17.84	1.11	0.63	40.18	21.40	1.54
350.0	15.59	20.01	21.02	17.83	1.11	0.63	37.84	21.36	1.56
400.0	15.54	20.06	20.88	17.78	1.12	0.63	39.62	21.31	1.57
450.0	15.49	20.04	20.70	17.65	1.12	0.64	39.30	21.36	1.56
500.0	15.45	19.99	20.48	17.71	1.12	0.63	38.75	21.49	1.58
550.0	15.42	19.97	20.28	17.72	1.12	0.64	38.25	21.31	1.61
600.0	15.37	19.99	20.10	17.71	1.13	0.64	39.03	21.39	1.68
650.0	15.33	19.97	19.93	17.76	1.13	0.64	38.18	21.45	1.63
700.0	15.28	19.93	19.73	17.73	1.13	0.64	39.57	21.53	1.58
750.0	15.23	19.93	19.45	17.67	1.13	0.65	39.29	21.44	1.65
800.0	15.18	19.91	19.18	17.60	1.13	0.65	38.74	21.51	1.62
850.0	15.12	19.90	18.71	17.43	1.14	0.65	39.23	21.46	1.64
900.0	15.06	19.88	18.30	17.29	1.14	0.66	37.60	21.51	1.62
950.0	15.00	19.89	17.94	17.23	1.14	0.66	39.89	21.50	1.66
1000.0	14.94	19.82	17.56	17.24	1.14	0.66	38.23	21.48	1.66
1200.0	14.68	19.76	16.64	17.04	1.15	0.68	39.01	21.59	1.74
1400.0	14.40	19.66	15.61	16.76	1.16	0.69	37.23	21.55	1.76
1600.0	14.11	19.54	14.73	16.62	1.16	0.71	37.59	21.60	1.80
1800.0	13.82	19.44	14.12	16.46	1.17	0.73	36.59	21.40	1.79
2000.0	13.53	19.29	13.38	16.48	1.17	0.75	36.85	21.44	1.80
2200.0	13.22	19.18	13.03	16.38	1.18	0.76	38.17	21.61	1.84
2400.0	12.94	19.01	12.53	16.31	1.18	0.78	37.58	21.60	1.83
2600.0	12.63	18.92	12.40	16.37	1.20	0.79	37.09	21.59	2.03
2800.0	12.40	18.73	11.94	16.51	1.19	0.81	36.90	21.69	2.02
3000.0	12.15	18.57	11.71	16.37	1.19	0.82	36.69	21.55	1.94
3500.0	11.59	18.12	11.32	16.32	1.18	0.84	35.77	21.64	2.13
4000.0	11.13	17.65	10.65	15.94	1.16	0.85	36.82	21.71	2.13
4500.0	10.74	17.31	10.16	15.71	1.15	0.87	35.85	21.70	2.40
5000.0	10.46	16.81	9.73	15.19	1.11	0.87	36.71	21.81	2.56
5500.0	10.36	16.30	9.38	13.93	1.05	0.86	34.62	21.07	2.55
6000.0	10.24	15.70	9.02	13.19	1.00	0.83	35.02	21.01	2.67

Typical Performance Data

Definitions:

Input Return Loss = -S11 (dB)

Gain(Power Gain) = S21 (dB)

Reverse Isolation = -S12 (dB)

Output Return Loss = -S22 (dB)

TEST CONDITIONS: Vd = 4.00V, Id = 95.70mA @ Temperature = +85degC

FREQ	Gain	Isolation	Input Return Loss	Output Return Loss	Stability		IP-3 Output	1dB Comp. Output	Noise Figure
					K	Measure			
(MHz)	(dB)	(dB)	(dB)	(dB)	K	Measure	(dBm)	(dBm)	(dB)
50.0	17.66	21.77	10.77	13.86	0.98	0.69	38.50	20.04	1.89
100.0	16.77	21.06	15.10	18.81	1.07	0.67	39.31	19.86	1.91
150.0	16.53	20.89	17.12	21.23	1.10	0.66	39.54	20.02	1.99
200.0	16.43	20.87	18.05	22.37	1.11	0.66	40.32	19.99	1.96
250.0	16.36	20.83	18.41	22.94	1.11	0.66	40.62	19.90	1.99
300.0	16.30	20.84	18.52	23.25	1.12	0.67	39.79	20.15	2.05
350.0	16.25	20.77	18.48	23.36	1.11	0.67	39.57	20.11	1.97
400.0	16.19	20.77	18.35	23.56	1.12	0.67	41.77	20.06	2.02
450.0	16.14	20.74	18.22	23.47	1.12	0.67	41.14	20.09	2.03
500.0	16.08	20.70	18.08	23.28	1.12	0.68	40.59	20.22	2.01
550.0	16.03	20.71	17.92	22.93	1.12	0.68	40.17	19.99	2.04
600.0	15.96	20.66	17.80	22.51	1.12	0.68	39.70	20.10	2.18
650.0	15.90	20.62	17.56	22.09	1.12	0.69	39.59	20.17	2.13
700.0	15.83	20.60	17.39	21.72	1.12	0.69	38.75	20.24	2.08
750.0	15.76	20.55	17.07	21.32	1.12	0.69	38.83	20.13	2.13
800.0	15.68	20.55	16.81	21.12	1.12	0.70	39.07	20.22	2.13
850.0	15.60	20.51	16.50	20.91	1.13	0.70	39.45	20.19	2.20
900.0	15.52	20.48	16.21	20.74	1.13	0.71	39.48	20.20	2.11
950.0	15.44	20.42	15.96	20.52	1.13	0.71	38.18	20.24	2.17
1000.0	15.36	20.39	15.71	20.24	1.13	0.72	38.24	20.22	2.09
1200.0	15.00	20.24	14.81	18.78	1.13	0.74	39.07	20.32	2.26
1400.0	14.62	20.05	13.94	17.99	1.13	0.76	38.58	20.27	2.30
1600.0	14.23	19.86	13.22	17.02	1.14	0.77	38.17	20.35	2.32
1800.0	13.84	19.67	12.62	16.24	1.14	0.79	38.31	20.16	2.31
2000.0	13.46	19.50	12.01	15.67	1.14	0.81	37.98	20.17	2.34
2200.0	13.06	19.33	11.62	15.16	1.15	0.83	37.06	20.36	2.39
2400.0	12.71	19.14	11.24	14.63	1.15	0.84	37.45	20.32	2.44
2600.0	12.32	19.01	11.00	14.36	1.16	0.85	36.66	20.29	2.62
2800.0	12.01	18.80	10.75	14.24	1.16	0.87	36.81	20.36	2.69
3000.0	11.70	18.60	10.46	13.83	1.16	0.87	36.48	20.23	2.63
3500.0	10.98	18.18	10.09	13.51	1.16	0.89	36.18	20.24	2.89
4000.0	10.41	17.66	9.63	13.16	1.15	0.91	36.02	20.25	2.95
4500.0	9.96	17.17	9.27	12.84	1.12	0.92	35.88	20.14	3.26
5000.0	9.66	16.76	9.05	12.49	1.10	0.92	35.06	20.12	3.40
5500.0	9.46	16.15	8.59	11.50	1.03	0.91	34.00	19.56	3.51
6000.0	9.24	15.58	8.25	10.84	0.98	0.89	34.17	19.54	3.67

Typical Performance Data

Definitions:

Input Return Loss = -S11 (dB)

Gain(Power Gain) = S21 (dB)

Reverse Isolation = -S12 (dB)

Output Return Loss = -S22 (dB)

TEST CONDITIONS: Vd = 4.50V, Id = 122.02mA @ Temperature = +85degC

FREQ	Gain	Isolation	Input Return Loss	Output Return Loss	Stability		IP-3 Output	1dB Comp. Output	Noise Figure
					K	Measure			
(MHz)	(dB)	(dB)	(dB)	(dB)	K	Measure	(dBm)	(dBm)	(dB)
50.0	17.89	21.51	11.01	14.04	0.97	0.65	41.01	21.39	1.98
100.0	17.01	21.20	15.40	18.99	1.07	0.66	41.88	21.21	1.97
150.0	16.78	21.07	17.46	21.46	1.09	0.65	42.18	21.38	2.04
200.0	16.68	21.01	18.44	22.64	1.10	0.65	44.44	21.34	1.97
250.0	16.61	20.96	18.88	23.25	1.11	0.65	40.08	21.22	2.02
300.0	16.55	20.97	19.01	23.65	1.11	0.66	48.44	21.50	2.01
350.0	16.50	20.99	18.94	23.92	1.12	0.66	44.38	21.46	2.01
400.0	16.44	20.95	18.81	24.12	1.12	0.66	54.94	21.41	2.07
450.0	16.39	20.90	18.71	24.16	1.12	0.66	42.17	21.45	2.04
500.0	16.33	20.88	18.53	24.05	1.12	0.67	45.91	21.57	2.05
550.0	16.29	20.88	18.36	23.70	1.12	0.67	42.24	21.30	2.16
600.0	16.21	20.88	18.23	23.29	1.12	0.68	50.18	21.43	2.19
650.0	16.15	20.80	18.01	22.93	1.12	0.68	45.12	21.52	2.14
700.0	16.08	20.82	17.82	22.61	1.12	0.68	46.79	21.57	2.12
750.0	16.01	20.76	17.49	22.28	1.12	0.69	48.43	21.45	2.15
800.0	15.94	20.76	17.24	22.12	1.13	0.69	43.09	21.57	2.15
850.0	15.86	20.72	16.90	21.96	1.13	0.70	52.07	21.53	2.19
900.0	15.78	20.70	16.60	21.84	1.13	0.70	47.62	21.54	2.13
950.0	15.70	20.65	16.35	21.64	1.13	0.71	43.01	21.59	2.19
1000.0	15.62	20.60	16.10	21.40	1.13	0.71	46.93	21.57	2.16
1200.0	15.27	20.44	15.17	19.93	1.13	0.73	43.83	21.67	2.26
1400.0	14.90	20.31	14.27	19.19	1.14	0.75	44.34	21.62	2.31
1600.0	14.51	20.13	13.53	18.17	1.14	0.77	45.66	21.69	2.38
1800.0	14.13	19.99	12.90	17.41	1.15	0.79	43.36	21.47	2.40
2000.0	13.75	19.78	12.30	16.81	1.15	0.81	41.76	21.49	2.41
2200.0	13.37	19.63	11.86	16.26	1.16	0.83	41.06	21.73	2.47
2400.0	13.01	19.41	11.47	15.70	1.16	0.84	42.88	21.67	2.47
2600.0	12.63	19.32	11.25	15.40	1.17	0.86	42.00	21.64	2.71
2800.0	12.33	19.12	10.97	15.23	1.17	0.87	40.87	21.71	2.73
3000.0	12.02	18.90	10.65	14.79	1.17	0.88	40.96	21.55	2.69
3500.0	11.31	18.47	10.25	14.38	1.17	0.90	40.38	21.57	2.93
4000.0	10.74	17.95	9.72	13.90	1.15	0.91	39.99	21.60	3.03
4500.0	10.29	17.44	9.34	13.52	1.13	0.92	39.26	21.58	3.36
5000.0	10.00	17.04	9.07	13.16	1.10	0.93	39.36	21.55	3.50
5500.0	9.80	16.44	8.53	12.01	1.02	0.92	37.91	20.83	3.58
6000.0	9.61	15.80	8.17	11.30	0.97	0.90	37.93	20.79	3.82

Typical Performance Curves

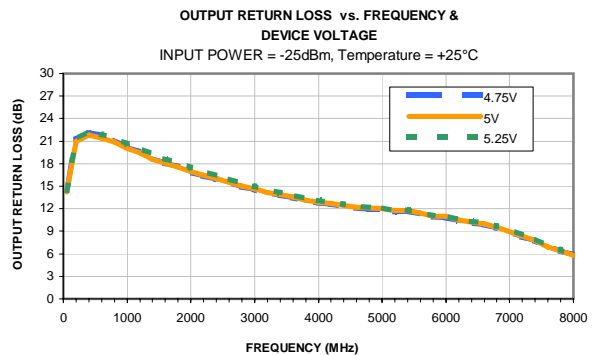
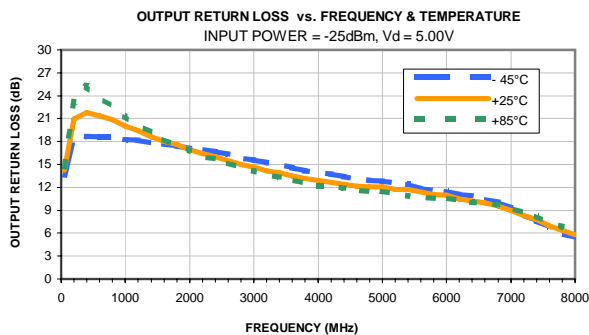
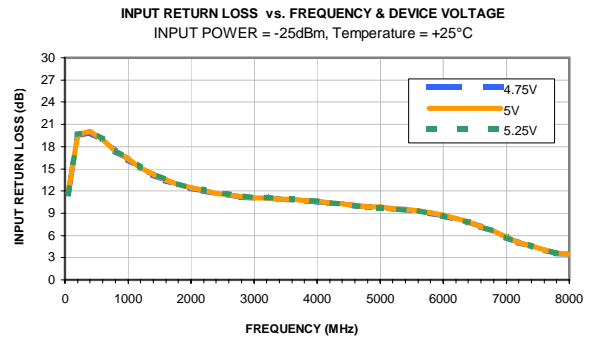
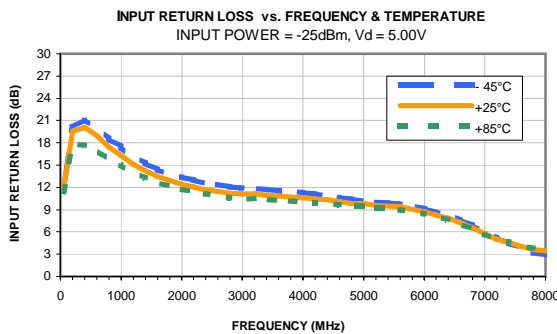
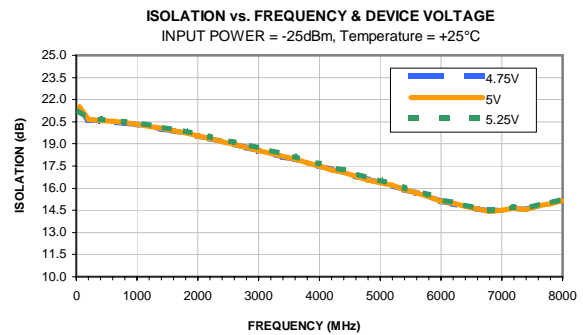
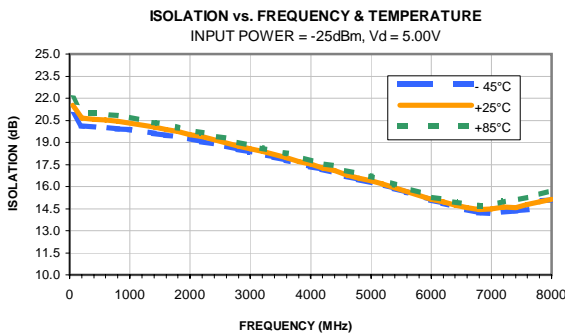
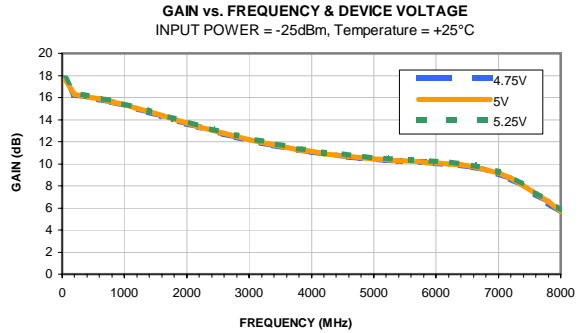
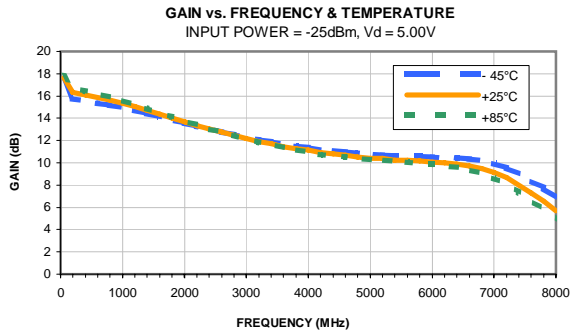

Typical Performance Curves

OUTPUT IP3 vs. FREQUENCY & TEMPERATURE
OUTPUT POWER = 5 dBm/1tone, Vd = 5.00V

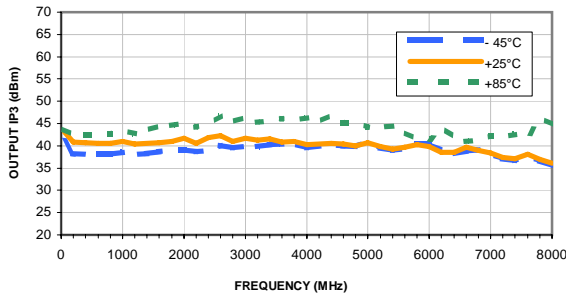

OUTPUT IP3 vs. FREQUENCY & DEVICE VOLTAGE
OUTPUT POWER = 5 dBm/1tone, Temperature = +25°C

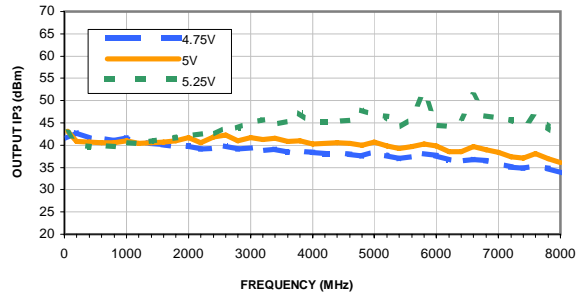

P1dB vs. FREQUENCY & TEMPERATURE
Vd = 5.00V

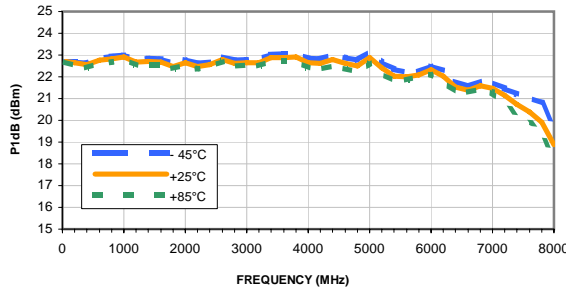

P1dB vs. FREQUENCY & DEVICE VOLTAGE
Temperature = +25°C

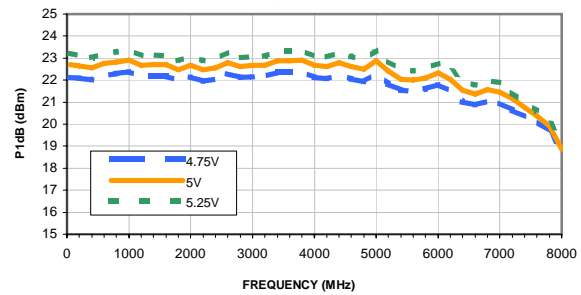

NOISE FIGURE vs. FREQUENCY & TEMPERATURE
Vd = 5.00V

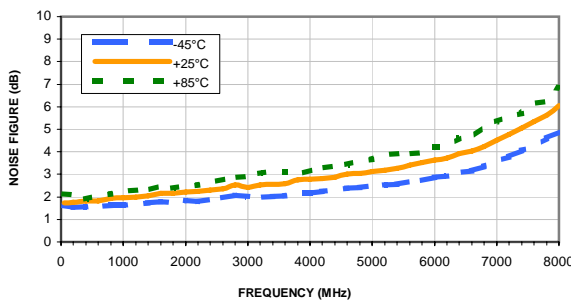

NOISE FIGURE vs. FREQUENCY & DEVICE VOLTAGE
Temperature = +25°C

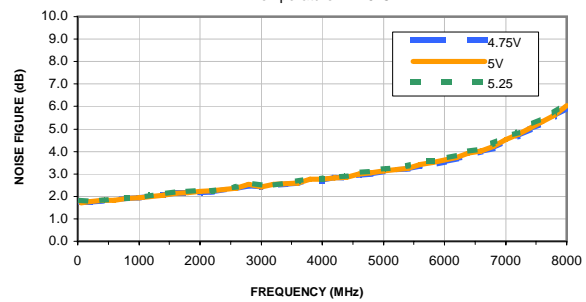

GAIN VARIATION vs. FREQUENCY & TEMPERATURE
INPUT POWER = -25dBm, Vd = 5.00V

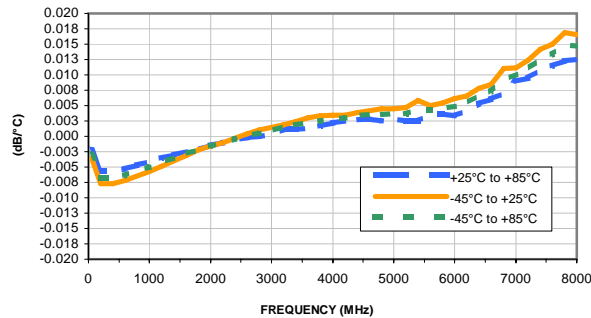

Typical Performance Curves

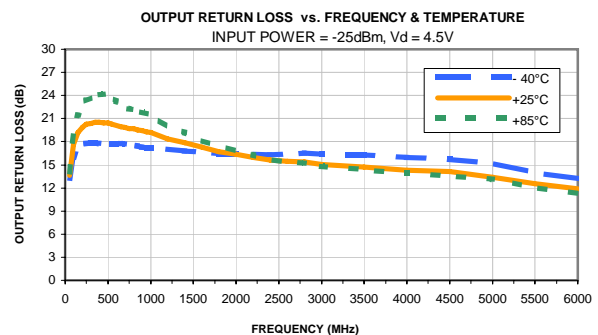
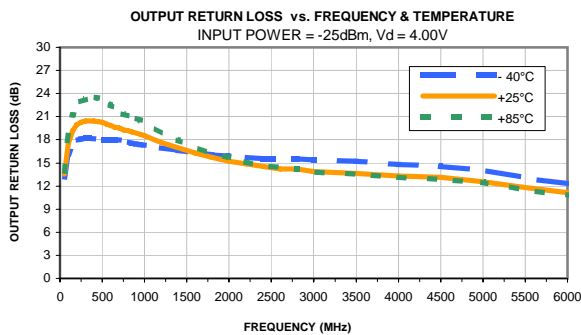
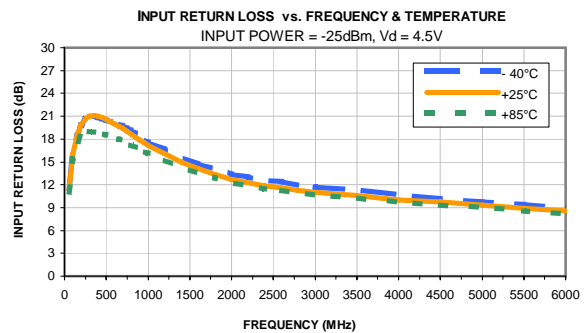
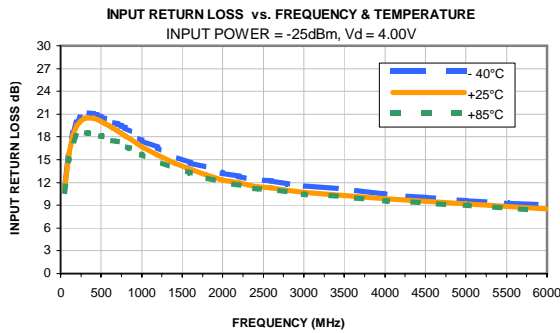
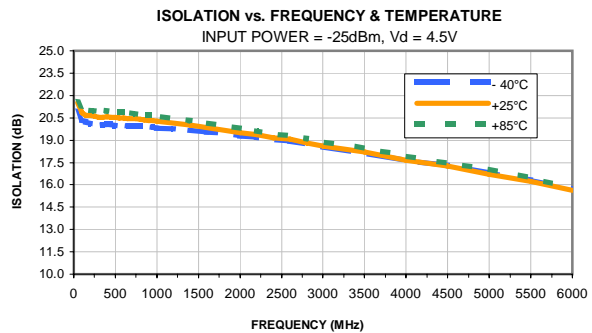
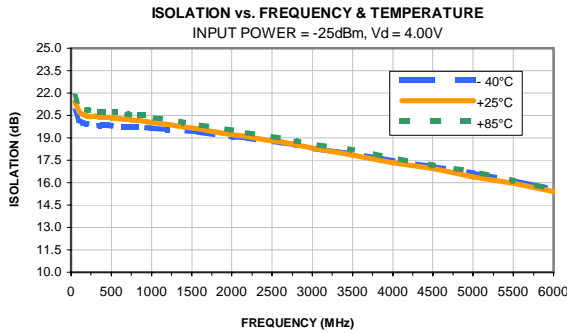
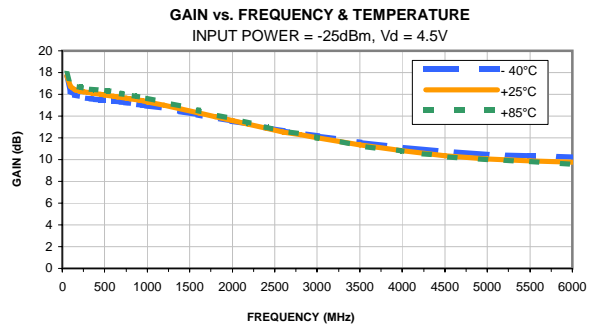
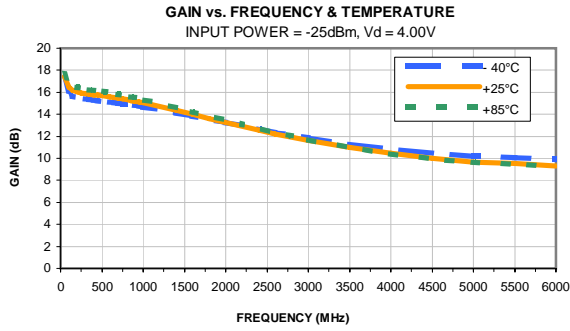

Typical Performance Curves

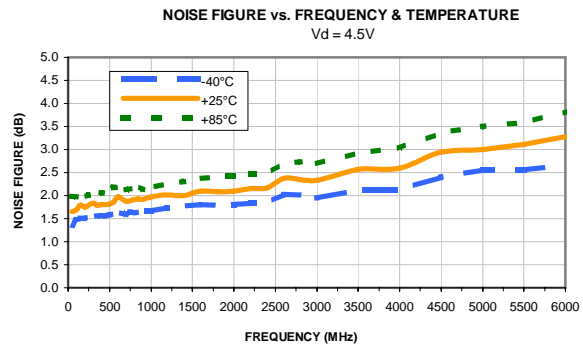
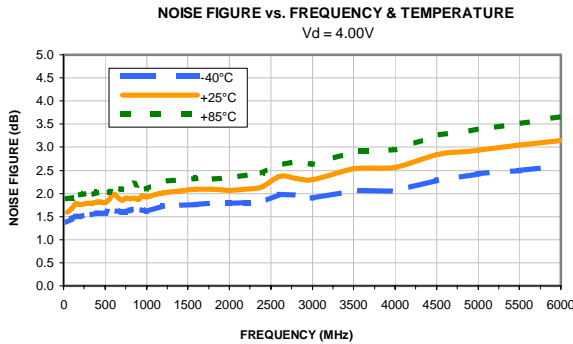
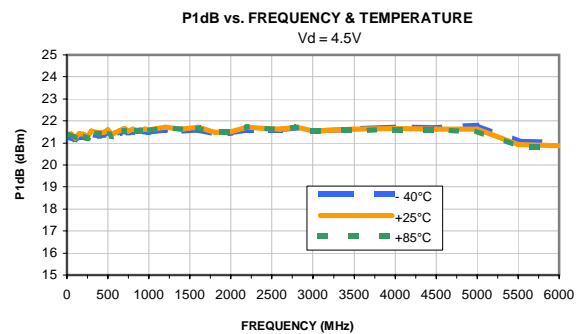
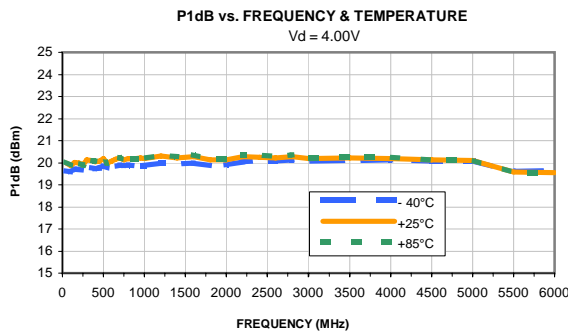
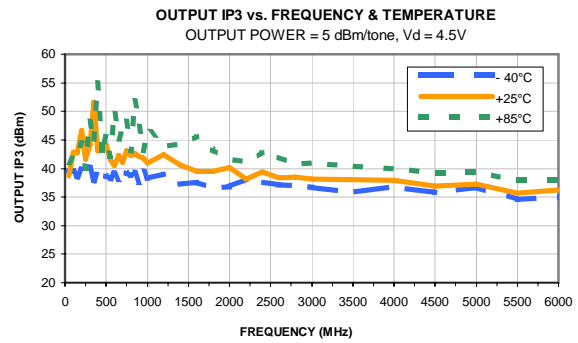
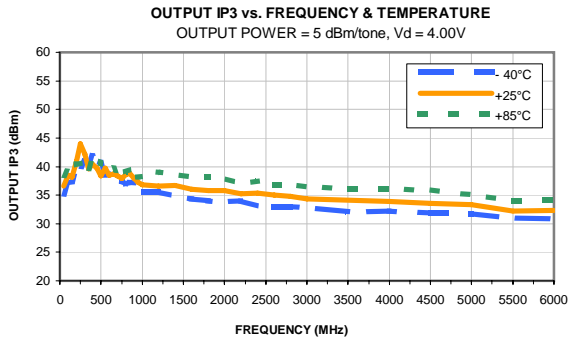

Typical Performance Curves

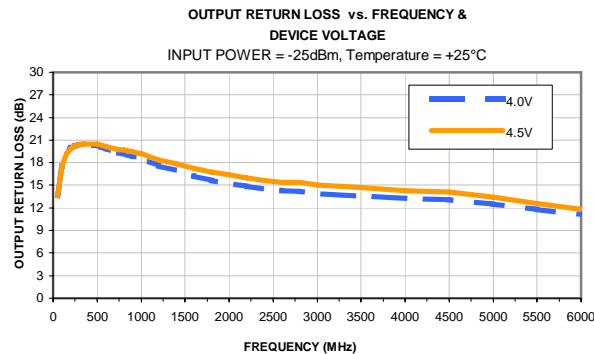
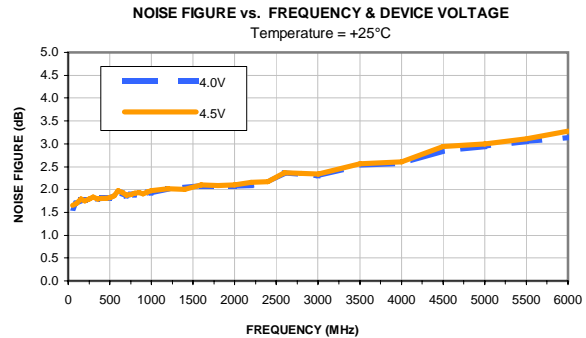
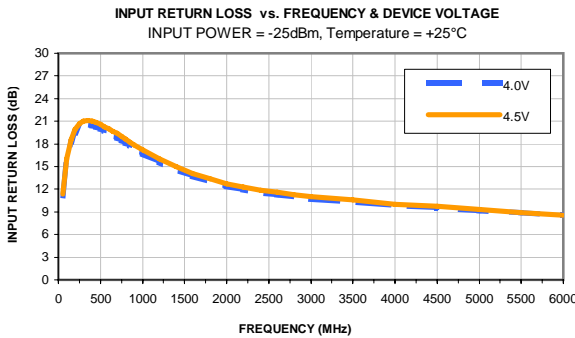
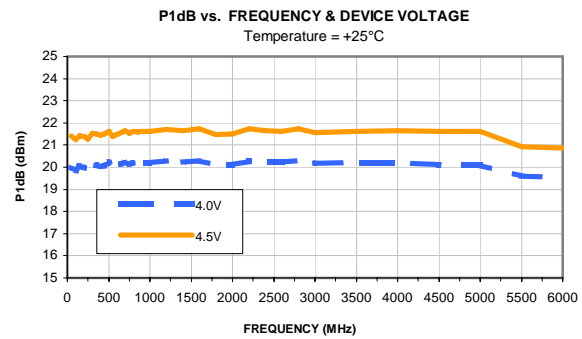
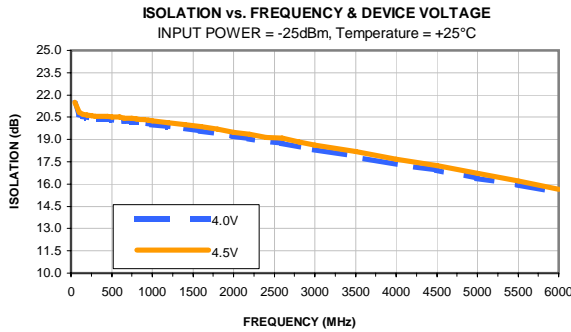
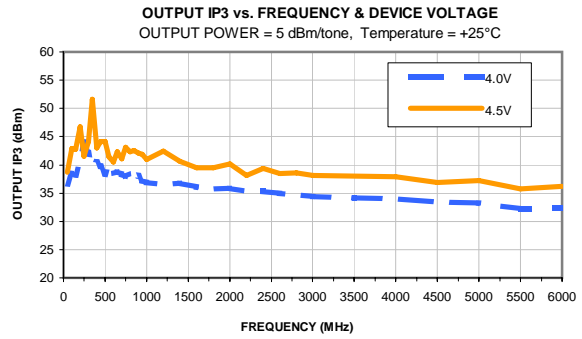
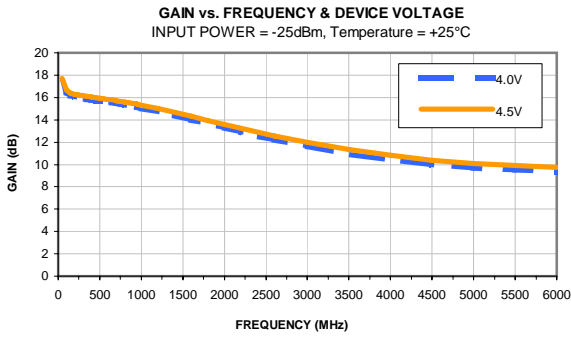

Outline Dimensions



PCB Land Pattern

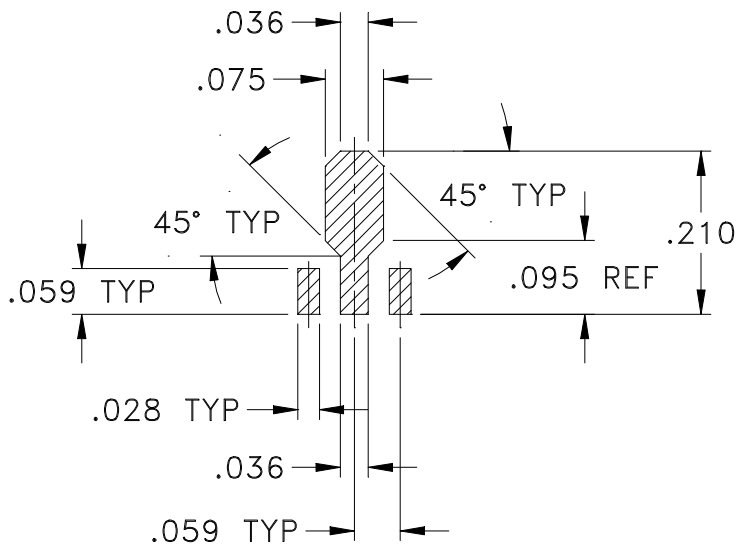

Suggested Layout,
Tolerance to be within $\pm .002$

CASE #	A	B	C	D	E	F	G	H	J	K	L	M
DF782	.102 (2.59)	.090 (2.29)	.181 (4.60)	.173 (4.39)	.063 (1.60)	.167 (4.24)	.155 (3.94)	.059 (1.50)	.118 (3.00)	.015 (0.38)	.041 (1.04)	.016 (0.41)

CASE #	N	P	Q	WT. GRAM
DF782	.019 (0.48)	.065 (1.65)	.062 (1.57)	.2

Dimensions are in inches (mm). Tolerances: 2 Pl. $\pm .01$; 3Pl. $\pm .005$

Notes:

- Case material: Plastic.
- Termination finish:
 For RoHS Case Styles: Tin-Silver alloy plate over Nickel barrier or Matte-Tin.
 All models, (+) suffix. See model Data sheet.
 For RoHS-5 Case Styles: Tin-Lead plate. All models, no (+) suffix.



INTERNET <http://www.minicircuits.com>

P.O. Box 350166, Brooklyn, New York 11235-0003 (718) 934-4500 Fax (718) 332-4661

Distribution Centers NORTH AMERICA 800-654-7949 • 417-335-5935 • Fax 417-335-5945 • EUROPE 44-1252-832600 • Fax 44-1252-837010

Mini-Circuits ISO 9001 & ISO 14001 Certified

Tape & Reel Packaging TR-F55

DEVICE ORIENTATION IN T&R



Tape Width, mm	Device Cavity Pitch, mm	Reel Size, inches	Devices per Reel	
12	8	7	Small quantity standard (see note)	20
				50
				100
				200
				500
			Standard	1000

Note: Please consult individual model data sheet to determine device per reel availability.

Mini-Circuits carrier tape materials provide protection from ESD (Electro-Static Discharge) during handling and transportation. Tapes are static dissipative and comply with industry standards EIA-481/EIA-541.

Go to: www.minicircuits.com/pages/pdfs/tape.pdf



INTERNET <http://www.minicircuits.com>

P.O. Box 350166, Brooklyn, New York 11235-0003 (718) 934-4500 Fax (718) 332-4661

Distribution Centers NORTH AMERICA 800-654-7949 • 417-335-5935 • Fax 417-335-5945 • EUROPE 44-1252-832600 • Fax 44-1252-837010

Mini-Circuits ISO 9001 & ISO 14001 Certified

THIRD ANGLE PROJECTION

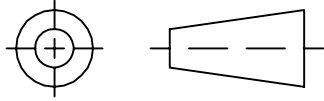

REVISIONS

REV	ECN No.	DESCRIPTION	DATE	DR	AUTH
OR	M123948	NEW RELEASE	08/18/09	MMG	DJ

SUGGESTED MOUNTING CONFIGURATION
FOR DF782 CASE STYLE, "04AM03" PIN CODE

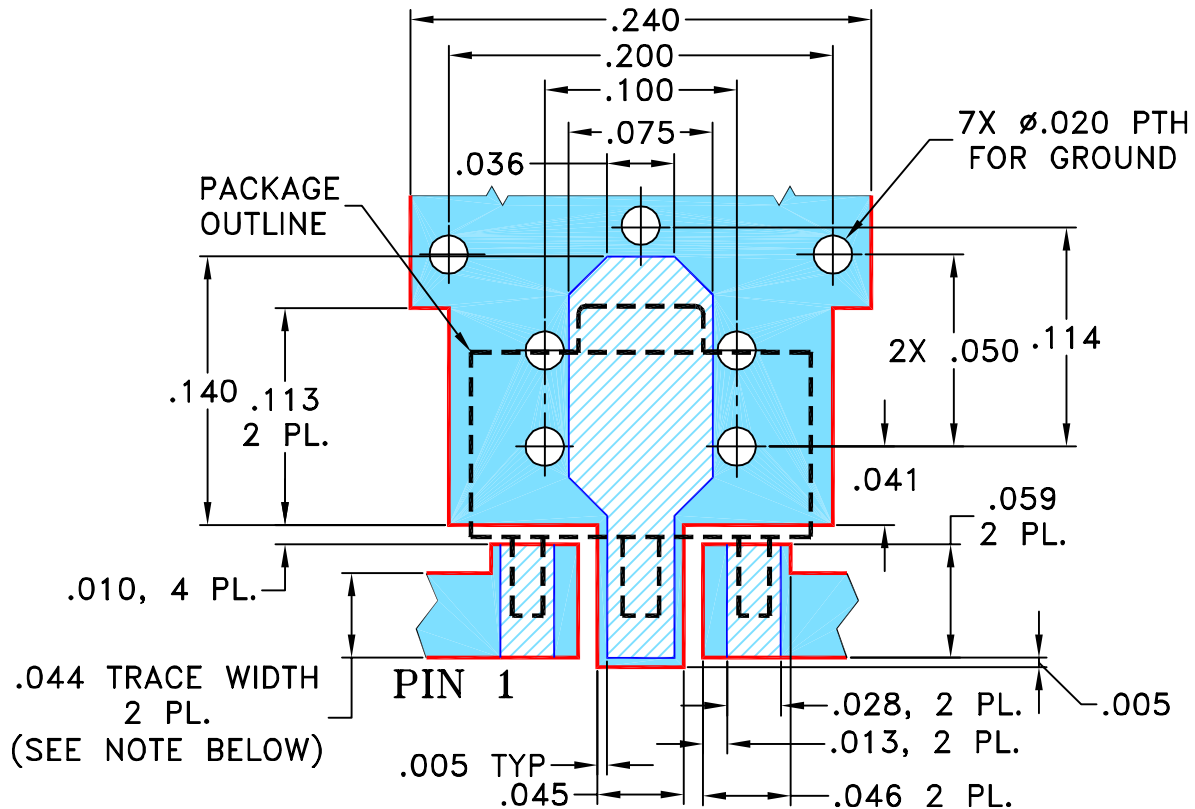

- NOTES:** 1. TRACE WIDTH IS SHOWN FOR ROGERS R04350B WITH DIELECTRIC THICKNESS .020" ± .0015"; COPPER: 1/2 OZ. EACH SIDE. FOR OTHER MATERIALS TRACE WIDTH MAY NEED TO BE MODIFIED.
2. BOTTOM SIDE OF THE PCB IS CONTINUOUS GROUND PLANE.



DENOTES PCB COPPER LAYOUT WITH SMOBC
(SOLDER MASK OVER BARE COPPER)



DENOTES COPPER LAND PATTERN FREE OF SOLDER MASK

UNLESS OTHERWISE SPECIFIED	INITIALS	DATE
DIMENSIONS ARE IN INCHES TOLERANCES ON: 2 PL DECIMALS ± 3 PL DECIMALS ± .005 ANGLES ± FRACTIONS ±	DRAWN	MMG 08/17/09
	CHECKED	AV 08/17/09
	APPROVED	DJ 08/18/09

 **Mini-Circuits®** 13 Neptune Avenue
Brooklyn NY 11235

PL, 04AM03, DF782, TB-545-1+

SIZE A	CODE IDENT 15542	DRAWING NO: 98-PL-313	REV: OR
FILE: 98PL313	SCALE: 10:1	SHEET: 1 OF 1	

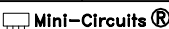
 Mini-Circuits®
THIS DOCUMENT AND ITS CONTENTS ARE THE PROPERTY OF MINI-CIRCUITS. EXCEPT FOR USE EXPRESSLY GRANTED, IN WRITING, TO ITS VENDORS, VENDEE AND THE UNITED STATES GOVERNMENT, MINI-CIRCUITS RESERVES ALL PROPRIETARY DESIGN, USE, MANUFACTURING AND REPRODUCTION RIGHTS THERETO. THESE CONTENTS SHALL NOT BE USED, DUPLICATED OR DISCLOSED TO ANY OUTSIDE PARTY, IN WHOLE OR IN PART, WITHOUT WRITTEN PERMISSION OF MINI-CIRCUITS.

Evaluation Board and Circuit

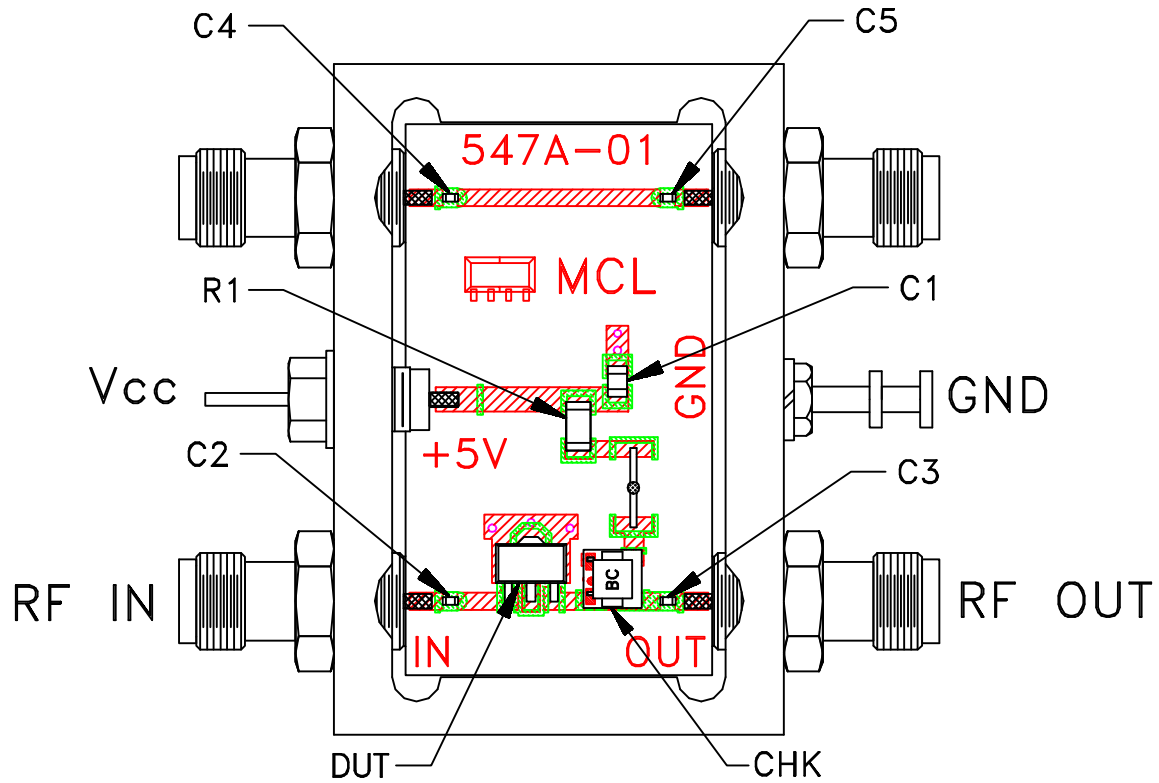

TB-545-1+

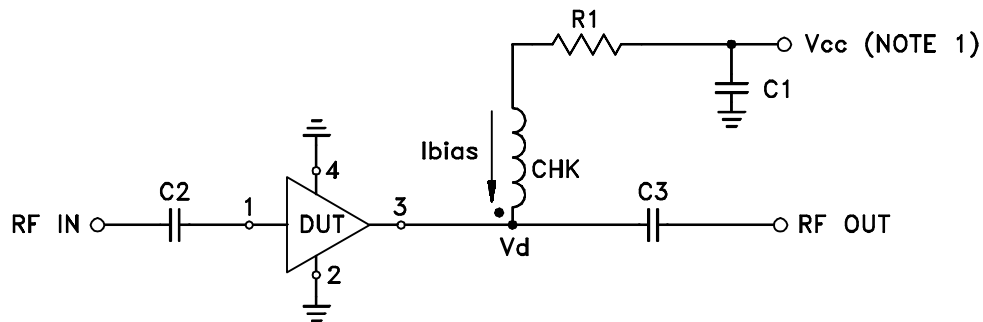

COMPONENT	VALUE
DUT	PHA-1+
C1 (bypass)	0.1 μ F
C2-C5 (Note 4)	0.001 μ F
R1	0 Ohm, 0.25W
CHK	Mini-Circuits TCCH-80+

Schematic Diagram

NOTES:

1. Vcc voltage: $+5 \pm 0.2$ V.
2. SMA Female connectors.
3. PCB material: Rogers R04350 or equivalent, dielectric constant=3.5, dielectric thickness=.020 inch.
4. Capacitor C2-C5 should be free of resonance up to the highest frequency specified.

 **Mini-Circuits®**

All Mini-Circuits products are manufactured under exacting quality assurance and control standards, and are capable of meeting published specifications after being subjected to any or all of the following physical and environmental test.

Specification	Test/Inspection Condition	Reference/Spec
Operating Temperature	-40° to 85°C Ambient Environment	Individual Model Data Sheet
Storage Temperature	-55° to 100° C or -65° to 150° Ambient Environment	Individual Model Data Sheet
Thermal Shock	-55° to 100°C, 100 cycles	MIL-STD-202, Method 107, Condition A-3, except +100°C
Mechanical Shock	1.5Kg, 0.5 ms, 5 shock pulses, Y1 direction only	MIL-STD-883, Method 2002, Condition B, except Y1 direction only
Vibration (Variable Frequency)	50g peak	MIL-STD-883, Method 2007, Condition B
Autoclave	15 psig, 100% RH, 121°C, 96 hours	JESD22-A102, Condition C
HAST	130°C, 85% RH, 96 hours	JESD22-A110
Solderability	10X Magnification	J-STD-002, Para 4.2.5, Test S, 95% Coverage
Solder Reflow Heat	Sn-Pb Eutetic Process: 240°C peak Pb-Free Process: 260°C peak	J-STD-020, Table 4-1, 4-2 and 5-2; Figure 5-1
Moisture Sensitivity: Level 1	Bake at 125°C for 24 hours Soak at 85°C/85% RH for 168 hours, Reflow 3 cycles at 260°C peak	J-STD-020
Marking Resistance to Solvents	Isopropyl alcohol + mineral spirits at 25°C; terpene defluxer at 25°C; distilled water + proylene glycol monomethyl ether +	MIL-STD-202, Method 215



All Mini-Circuits products are manufactured under exacting quality assurance and control standards, and are capable of meeting published specifications after being subjected to any or all of the following physical and environmental test.

Specification	Test/Inspection Condition	Reference/Spec
---------------	---------------------------	----------------

monoethanolamine at 63°C to 70°C