

Surface Mount

# Monolithic Amplifier

DC-6 GHz

## Product Features

- High gain, 25.6 dB typ. at 100 MHz
- High IP3, 38 dBm typ.
- High Pout, P1dB 21.9 dBm typ.
- Internally Matched to 50 Ohms
- Transient Protected
- Excellent ESD Protection
- Unconditionally stable
- Aqueous washable
- Protected by US Patent 6,943,629
- Low additive phase noise, typically -172 dBc/Hz @ 10 KHz

## Typical Applications

- Base station infrastructure
- Portable Wireless
- CATV & DBS
- MMDS & Wireless LAN
- Suitable for low phase noise applications

## General Description

Gali $\omega$ 84+ (RoHS compliant) is a wideband amplifier offering high dynamic range. Lead finish is SnAgNi. It has repeatable performance from lot to lot, and is enclosed in a SOT-89 package. It uses patented Transient Protected Darlington configuration and is fabricated using InGaP HBT technology. Expected MTTF is 1200 years at 85°C case temperature. Gali $\omega$ 84+ is designed to be rugged for ESD and supply switch-on transients.

## simplified schematic and pin description

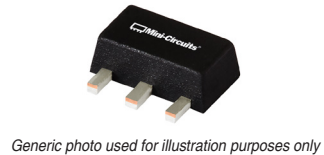
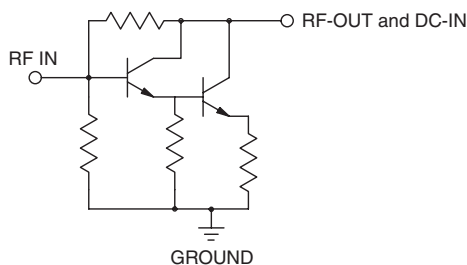

Generic photo used for illustration purposes only

## Gali $\omega$ 84+

CASE STYLE: DF782

**+RoHS Compliant**

The +Suffix identifies RoHS Compliance. See our web site for RoHS Compliance methodologies and qualifications

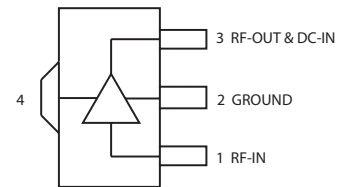

Function	Pin Number	Description
RF IN	1	RF input pin. This pin requires the use of an external DC blocking capacitor chosen for the frequency of operation.
RF-OUT and DC-IN	3	RF output and bias pin. DC voltage is present on this pin; therefore a DC blocking capacitor is necessary for proper operation. An RF choke is needed to feed DC bias without loss of RF signal due to the bias connection, as shown in "Recommended Application Circuit".
GND	2,4	Connections to ground. Use via holes as shown in "Suggested Layout for PCB Design" to reduce ground path inductance for best performance.

### Notes

- Performance and quality attributes and conditions not expressly stated in this specification document are intended to be excluded and do not form a part of this specification document.
- Electrical specifications and performance data contained in this specification document are based on Mini-Circuit's applicable established test performance criteria and measurement instructions.
- The parts covered by this specification document are subject to Mini-Circuits standard limited warranty and terms and conditions (collectively, "Standard Terms"); Purchasers of this part are entitled to the rights and benefits contained therein. For a full statement of the Standard Terms and the exclusive rights and remedies thereunder, please visit Mini-Circuits' website at [www.minicircuits.com/MCLStore/terms.jsp](http://www.minicircuits.com/MCLStore/terms.jsp)



**Electrical Specifications at 25°C and 100mA, unless noted**

Parameter	Min.	Typ.	Max.	Units	Cpk	
Frequency Range*	DC		6	GHz		
Gain	f=0.1 GHz	24.3	25.6	26.9	dB	≥1.5
	f=1 GHz	—	22.7	—		
	f=2 GHz	18.2	19.2	20.2		
	f=3 GHz	—	16.7	—		
	f=4 GHz	14.3	15.0	15.8		
	f=6 GHz	—	11.8	—		
Magnitude of Gain Variation versus Temperature (values are negative)	f=0.1 GHz	—	0.0025	—	dB/°C	
	f=1 GHz	—	0.0036	—		
	f=2 GHz	—	0.0045	0.0090		
	f=3 GHz	—	0.0057	—		
	f=4 GHz	—	0.0074	—		
	f=6 GHz	—	0.0148	—		
Input Return Loss	f=0.1 GHz	—	25.8	—	dB	
	f=1 GHz	—	21.2	—		
	f=2 GHz	14.0	18.0	—		
	f=3 GHz	—	15.6	—		
	f=4 GHz	—	14.7	—		
	f=6 GHz	—	16.7	—		
Output Return Loss	f=0.1 GHz	—	16.3	—	dB	
	f=1 GHz	—	11.0	—		
	f=2 GHz	6.0	8.9	—		
	f=3 GHz	—	9.0	—		
	f=4 GHz	—	9.7	—		
	f=6 GHz	—	8.4	—		
Reverse Isolation	f=2 GHz	22	26.5	—	dB	
Output Power @1 dB compression	f=0.1 GHz	20.8	21.9	—	dBm	≥1.5
	f=1 GHz	20.4	21.5	—		
	f=2 GHz	20.1	21.2	—		
	f=3 GHz	—	20.9	—		
	f=4 GHz	—	19.2	—		
	f=6 GHz	—	15.5	—		
Saturated Output Power (at 3dB compression)	f=0.1 GHz	—	23.0	—	dBm	
	f=1 GHz	—	22.6	—		
	f=2 GHz	—	22.1	—		
	f=3 GHz	—	21.7	—		
	f=4 GHz	—	20.3	—		
	f=6 GHz	—	17.1	—		
Output IP3	f=0.1 GHz	33.8	37.6	—	dBm	≥1.5
	f=1 GHz	34.0	37.8	—		
	f=2 GHz	34.2	38.0	—		
	f=3 GHz	—	37.4	—		
	f=4 GHz	—	34.7	—		
	f=6 GHz	—	32.7	—		
Noise Figure	f=0.1 GHz	—	4.2	—	dBm	≥1.5
	f=1 GHz	—	4.4	—		
	f=2 GHz	—	4.4	—		
	f=3 GHz	—	4.4	—		
	f=4 GHz	—	4.6	—		
	f=6 GHz	—	5.3	—		
Additive Phase Noise	2 GHz, 10 KHz offset	—	-172	—	dBc/Hz	
Group Delay	f=2 GHz	—	94	—	psec	
Recommended Device Operating Current		—	100	—	mA	
Device Operating Voltage		5.4	5.8	6.2	V	≥1.5
Device Voltage Variation vs. Temperature at 100mA		—	-3.6	—	mV/°C	
Device Voltage Variation vs Current at 25°C		—	3.3	—	mV/mA	

\*Guaranteed specification DC-6 GHz. Low frequency cut off determined by external coupling capacitors.

**Absolute Maximum Ratings**

Parameter	Ratings
Operating Temperature*	-45°C to 85°C
Storage Temperature	-65°C to 150°C
Operating Current	160mA
Power Dissipation	1W
Input Power	13 dBm

Note: Permanent damage may occur if any of these limits are exceeded. These ratings are not intended for continuous normal operation.  
<sup>1</sup>Case is defined as ground leads.  
 \*Based on typical case temperature rise 9°C above ambient.

**Notes**

- A. Performance and quality attributes and conditions not expressly stated in this specification document are intended to be excluded and do not form a part of this specification document.
- B. Electrical specifications and performance data contained in this specification document are based on Mini-Circuit's applicable established test performance criteria and measurement instructions.
- C. The parts covered by this specification document are subject to Mini-Circuits standard limited warranty and terms and conditions (collectively, "Standard Terms"); Purchasers of this part are entitled to the rights and benefits contained therein. For a full statement of the Standard Terms and the exclusive rights and remedies thereunder, please visit Mini-Circuits' website at [www.minicircuits.com/MCLStore/terms.jsp](http://www.minicircuits.com/MCLStore/terms.jsp)



**Product Marking**

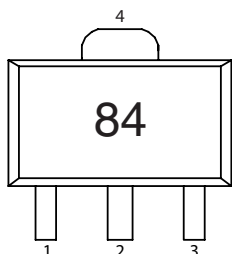

Markings in addition to model number designation may appear for internal quality control purposes.

**Additional Detailed Technical Information**

Additional information is available on our web site. To access this information enter the model number on our web site home page.

**Performance data, graphs, s-parameter data set (.zip file)**

**Case Style: DF782**

Plastic package, exposed paddle, lead finish: Matte-Tin

**Tape & Reel: F55**

7” reels with 20, 50, 100, 200, 500, 1K devices.

**Suggested Layout for PCB Design: PL-019**

**Evaluation Board: TB-409-84+**

**Environmental Ratings: ENV08T2**

**Recommended Application Circuit**

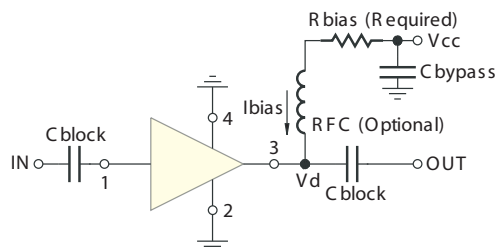

Test Board includes case, connectors, and components (in bold) soldered to PCB

R BIAS	
Vcc	“1%” Res. Values (ohms) for Optimum Biasing
8	22.1
9	32.4
10	42.2
11	52.3
12	61.9
13	71.5
14	82.5
15	93.1
16	102
17	113
18	121
19	133
20	140

**Notes**

- A. Performance and quality attributes and conditions not expressly stated in this specification document are intended to be excluded and do not form a part of this specification document.
- B. Electrical specifications and performance data contained in this specification document are based on Mini-Circuit's applicable established test performance criteria and measurement instructions.
- C. The parts covered by this specification document are subject to Mini-Circuits standard limited warranty and terms and conditions (collectively, "Standard Terms"); Purchasers of this part are entitled to the rights and benefits contained therein. For a full statement of the Standard Terms and the exclusive rights and remedies thereunder, please visit Mini-Circuits' website at [www.minicircuits.com/MCLStore/terms.jsp](http://www.minicircuits.com/MCLStore/terms.jsp)



**ESD Rating**

Human Body Model (HBM): Class 1C (1000v to < 2000v) in accordance with ANSI/ESD STM 5.1 - 2001

Machine Model (MM): Class M2 (< 100v) in accordance with ANSI/ESD STM 5.2 - 1999

**MSL Rating**

Moisture Sensitivity: MSL1 in accordance with IPC/JEDECJ-STD-020C

No.	Test Required	Condition	Standard	Quantity
1	Visual Inspection	Low Power Microscope Magnification 40x	MIP-IN-0003 (MCT spec)	45 units
2	Electrical Test	Room Temperature	SCD (MCL spec)	45 units
3	SAM Analysis	Less than 10% growth in term of delamination	J-Std-020C (Jedec Standard)	45 units
4	Moisture Sensitivity Level 1	Bake at 125°C for 24 hours Soak at 85°C/85%RH for 168 hours Reflow 3 cycles at 260°C peak	J-Std-020C (Jedec Standard)	45 units

**MSL Test Flow Chart**

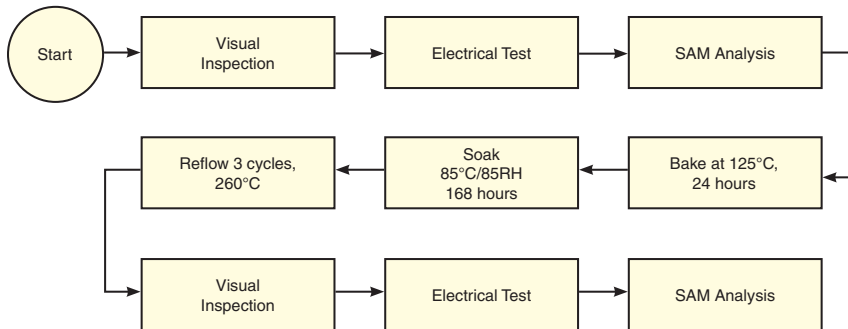

**Notes**

- A. Performance and quality attributes and conditions not expressly stated in this specification document are intended to be excluded and do not form a part of this specification document.
- B. Electrical specifications and performance data contained in this specification document are based on Mini-Circuit's applicable established test performance criteria and measurement instructions.
- C. The parts covered by this specification document are subject to Mini-Circuits standard limited warranty and terms and conditions (collectively, "Standard Terms"); Purchasers of this part are entitled to the rights and benefits contained therein. For a full statement of the Standard Terms and the exclusive rights and remedies thereunder, please visit Mini-Circuits' website at [www.minicircuits.com/MCLStore/terms.jsp](http://www.minicircuits.com/MCLStore/terms.jsp)



## Typical Performance Data

**NOTE: Use PDF Bookmarks to view DATA at required conditions  
or to view GRAPHS.**

**Definitions:**

Input Return Loss = -S11 (dB)

Gain(Power Gain) = S21 (dB)

Reverse Isolation = -S12 (dB)

Output Return Loss = -S22 (dB)

TEST CONDITIONS: Icc = 100mA, Vd = 5.76V @Temperature = +25degC

FREQ	Gain	Isolation	Input Return Loss	Output Return Loss	Stability		FREQ	IP3 Output	1dB Comp. Output	Noise Figure
(MHz)	(dB)	(dB)	(dB)	(dB)	K	Delta	(MHz)	(dBm)	(dBm)	(dB)
50	25.68	29.60	25.63	16.34	1.08	0.63	50	37.67	21.85	4.07
100	25.65	29.87	25.32	16.02	1.09	0.61	100	37.59	21.91	4.22
200	25.50	29.53	25.84	15.53	1.08	0.62	200	37.76	21.70	4.23
400	25.06	29.43	24.81	14.14	1.08	0.59	400	37.38	21.77	4.30
600	24.43	29.26	24.03	12.67	1.09	0.56	600	37.16	21.49	4.30
800	23.72	28.96	23.13	11.58	1.10	0.53	800	37.58	21.49	4.47
1000	22.96	28.77	22.21	10.75	1.13	0.49	1000	37.79	21.53	4.38
1200	22.19	28.44	21.48	10.12	1.14	0.47	1200	37.63	21.12	4.41
1400	21.46	28.09	20.67	9.64	1.16	0.45	1400	37.30	21.10	4.32
1600	20.75	27.73	19.97	9.30	1.18	0.42	1600	37.71	21.17	4.48
1800	20.07	27.41	19.43	9.03	1.20	0.40	1800	38.26	21.06	4.52
2000	19.46	27.07	18.68	8.85	1.21	0.39	2000	38.03	21.16	4.33
2200	18.89	26.79	18.20	8.85	1.23	0.37	2200	37.73	21.26	4.38
2400	18.36	26.45	17.70	8.85	1.25	0.36	2400	37.43	21.26	4.47
2600	17.89	26.08	16.97	8.85	1.25	0.35	2600	37.13	21.14	4.45
2800	17.40	25.99	16.97	9.01	1.30	0.33	2800	37.29	21.03	4.41
3000	17.05	25.49	16.23	8.95	1.27	0.33	3000	37.35	20.88	4.39
3200	16.67	25.22	16.01	9.06	1.28	0.33	3200	37.32	20.70	4.47
3400	16.33	25.01	15.79	9.17	1.30	0.32	3400	37.16	20.45	4.55
3600	16.02	24.75	15.62	9.20	1.30	0.32	3600	36.60	20.22	4.64
3800	15.72	24.53	15.57	9.25	1.31	0.32	3800	35.47	19.78	4.60
4000	15.47	24.41	15.49	9.28	1.33	0.31	4000	34.65	19.23	4.64
4200	15.17	24.26	15.84	9.21	1.35	0.31	4200	35.11	18.81	4.69
4400	14.88	24.15	16.00	9.15	1.37	0.30	4400	34.83	18.52	4.74
4600	14.68	23.97	15.99	9.00	1.37	0.31	4600	34.50	18.14	4.89
4800	14.40	23.95	16.10	8.73	1.40	0.30	4800	34.24	17.67	4.98
5000	14.17	23.94	16.57	8.56	1.43	0.30	5000	33.96	17.23	5.02
5200	13.93	23.94	16.58	8.37	1.45	0.29	5200	33.96	16.89	5.02
5400	13.64	23.86	16.60	8.08	1.47	0.29	5400	33.36	16.66	5.12
5600	13.38	23.91	17.32	7.97	1.52	0.28	5600	33.19	16.42	5.14
6000	12.69	24.02	17.45	7.64	1.63	0.27	5800	33.07	15.95	5.35
6500	11.60	24.21	16.78	7.33	1.84	0.27	6000	32.75	15.50	5.27
7000	10.15	24.45	14.06	7.05	2.16	0.26	6200	32.89	15.08	5.28
7500	8.43	24.43	11.12	6.71	2.47	0.27	6400	32.80	14.65	5.30
8000	6.56	23.93	9.04	6.40	2.69	0.29	6600	32.24	14.35	5.41
8500	4.69	23.00	7.75	6.12	2.79	0.30	6800	32.31	14.18	5.52
9000	3.18	21.79	6.90	5.86	2.67	0.30	7000	33.07	14.00	5.60
10000	0.94	18.56	6.72	6.11	2.34	0.27	7200	33.50	13.57	5.58
12000	-1.34	11.90	7.50	7.28	1.61	0.26	7500	32.55	13.06	5.55
13000	-1.79	7.82	9.18	8.78	1.28	0.32	8000	30.07	11.61	6.10

REV. X1

GALI-84+

120123

Page 1 of 11



IF/RF MICROWAVE COMPONENTS • ISO 9001 ISO 14001 AS 9100 CERTIFIED • RoHS compliant

P.O. Box 350166, Brooklyn, New York 11235-0003 (718) 934-4500 Fax (718) 332-4661



The Design Engineers Search Engine finds the model you need, Instantly • For detailed performance specs & shopping online see



## Typical Performance Data

### Definitions:

Input Return Loss = -S11 (dB)

Gain(Power Gain) = S21 (dB)

Reverse Isolation = -S12 (dB)

Output Return Loss = -S22 (dB)

TEST CONDITIONS: Icc = 80mA, Vd=5.72V @Temperature = +25degC

FREQ	Gain	Isolation	Input Return Loss	Output Return Loss	Stability		FREQ	IP3 Output	1dB Comp. Output	Noise Figure
					K	Delta				
(MHz)	(dB)	(dB)	(dB)	(dB)	K	Delta	(MHz)	(dBm)	(dBm)	(dB)
50	25.43	28.60	22.54	18.45	1.04	0.69	50	33.82	19.25	4.09
100	25.36	29.30	22.08	18.12	1.08	0.63	100	33.63	19.34	4.21
200	25.21	29.11	21.97	17.33	1.07	0.63	200	33.72	19.15	4.22
400	24.79	29.15	21.97	15.28	1.09	0.59	400	33.69	18.96	4.39
600	24.16	28.92	21.57	13.49	1.09	0.56	600	33.79	19.05	4.32
800	23.47	28.60	21.25	12.13	1.10	0.53	800	34.46	18.79	4.44
1000	22.74	28.45	20.71	11.12	1.12	0.49	1000	34.84	18.88	4.37
1200	22.00	28.06	20.34	10.37	1.13	0.47	1200	34.94	19.17	4.38
1400	21.28	27.81	19.66	9.82	1.15	0.44	1400	34.82	19.32	4.45
1600	20.59	27.47	19.11	9.45	1.16	0.42	1600	35.19	19.21	4.45
1800	19.92	27.20	18.41	9.16	1.19	0.40	1800	35.95	19.09	4.38
2000	19.34	26.88	17.75	8.96	1.20	0.39	2000	35.76	19.11	4.32
2200	18.75	26.57	17.31	8.89	1.22	0.37	2200	35.88	19.06	4.39
2400	18.23	26.22	16.75	8.86	1.22	0.36	2400	35.76	19.09	4.38
2600	17.77	25.99	16.29	8.87	1.24	0.34	2600	35.79	18.94	4.42
2800	17.34	25.71	15.95	8.95	1.26	0.33	2800	35.68	18.59	4.40
3000	16.96	25.39	15.47	8.96	1.26	0.33	3000	35.76	18.08	4.44
3200	16.56	25.21	15.40	9.12	1.29	0.32	3200	35.76	17.87	4.39
3400	16.27	24.91	15.06	9.20	1.28	0.32	3400	35.48	17.66	4.54
3600	15.96	24.60	14.89	9.22	1.28	0.32	3600	35.16	17.30	4.57
3800	15.64	24.42	14.82	9.31	1.30	0.31	3800	34.29	16.77	4.69
4000	15.37	24.27	14.78	9.32	1.32	0.31	4000	33.51	16.41	4.65
4200	15.07	24.11	14.86	9.31	1.34	0.31	4200	33.47	16.13	4.81
4400	14.79	24.06	14.97	9.22	1.37	0.30	4400	33.47	15.86	4.71
4600	14.53	23.87	15.00	9.03	1.37	0.30	4600	33.04	15.68	4.89
4800	14.20	23.79	15.31	8.80	1.40	0.30	4800	32.61	15.35	4.88
5000	13.99	23.92	15.72	8.75	1.45	0.29	5000	32.53	14.75	5.05
5200	13.71	23.93	15.92	8.50	1.48	0.28	5200	32.46	13.32	5.01
5400	13.40	23.88	16.47	8.25	1.52	0.28	5400	32.02	12.95	5.15
5600	13.16	23.88	17.29	8.16	1.56	0.28	5600	31.62	13.44	5.22
6000	12.47	24.19	16.86	7.85	1.70	0.26	5800	31.43	13.41	5.27
6500	11.51	24.29	16.72	7.75	1.91	0.26	6000	31.38	13.35	5.34
7000	10.15	24.42	14.04	7.47	2.20	0.26	6200	31.51	13.41	5.35
7500	8.31	24.24	11.31	7.22	2.53	0.27	6400	31.88	13.49	5.36
8000	6.44	24.17	9.02	6.67	2.84	0.28	6600	31.00	13.50	5.48
8500	4.55	23.74	7.81	6.38	3.13	0.29	6800	30.55	13.47	5.62
9000	2.92	21.97	7.23	6.22	2.95	0.29	7000	30.45	13.43	5.75
10000	0.72	18.57	6.96	6.62	2.54	0.26	7200	30.89	12.86	5.81
12000	-1.52	12.08	7.54	7.45	1.69	0.25	7500	30.69	11.99	5.89
13000	-1.98	7.92	9.04	8.44	1.29	0.31	8000	29.31	11.45	6.53

## Typical Performance Data

### Definitions:

Input Return Loss = -S11 (dB)

Gain(Power Gain) = S21 (dB)

Reverse Isolation = -S12 (dB)

Output Return Loss = -S22 (dB)

TEST CONDITIONS: Icc = 120mA, Vd = 5.81V @Temperature = +25degC

FREQ	Gain	Isolation	Input Return Loss	Output Return Loss	Stability		FREQ	IP3 Output	1dB Comp. Output	Noise Figure
(MHz)	(dB)	(dB)	(dB)	(dB)	K	Delta	(MHz)	(dBm)	(dBm)	(dB)
50	25.85	30.23	28.44	15.16	1.10	0.60	50	40.55	22.76	4.14
100	25.82	29.88	28.42	14.89	1.08	0.62	100	40.66	22.85	4.31
200	25.66	29.82	29.12	14.57	1.08	0.61	200	40.70	22.72	4.28
400	25.21	29.66	27.02	13.44	1.09	0.59	400	39.88	22.81	4.38
600	24.57	29.48	25.60	12.25	1.10	0.56	600	39.10	22.50	4.38
800	23.85	29.23	24.38	11.26	1.11	0.53	800	38.91	22.50	4.54
1000	23.07	28.91	23.20	10.53	1.13	0.50	1000	38.85	22.54	4.46
1200	22.29	28.63	22.33	9.95	1.15	0.47	1200	38.61	22.34	4.48
1400	21.55	28.24	21.40	9.50	1.17	0.45	1400	38.23	22.32	4.41
1600	20.83	27.91	20.66	9.19	1.19	0.42	1600	38.46	22.35	4.56
1800	20.15	27.55	20.05	8.94	1.20	0.41	1800	38.81	22.23	4.61
2000	19.54	27.22	19.26	8.78	1.22	0.39	2000	38.42	22.20	4.43
2200	18.95	26.88	18.76	8.79	1.24	0.37	2200	38.04	22.15	4.47
2400	18.42	26.59	18.25	8.80	1.26	0.36	2400	37.75	22.01	4.54
2600	17.96	26.14	17.48	8.80	1.25	0.35	2600	37.35	21.92	4.55
2800	17.46	26.04	17.50	8.95	1.30	0.34	2800	37.45	21.81	4.49
3000	17.11	25.53	16.71	8.89	1.27	0.34	3000	37.51	21.68	4.49
3200	16.74	25.28	16.46	9.00	1.28	0.33	3200	37.45	21.36	4.58
3400	16.40	25.04	16.23	9.10	1.30	0.33	3400	37.50	21.07	4.68
3600	16.09	24.77	16.07	9.12	1.30	0.32	3600	36.88	20.83	4.76
3800	15.78	24.52	16.02	9.15	1.31	0.32	3800	35.94	20.37	4.70
4000	15.55	24.40	15.90	9.18	1.32	0.32	4000	35.12	19.77	4.76
4200	15.25	24.25	16.26	9.10	1.34	0.31	4200	35.13	19.34	4.82
4400	14.97	24.16	16.41	9.00	1.36	0.31	4400	35.53	19.09	4.87
4600	14.78	24.02	16.42	8.83	1.36	0.31	4600	34.96	18.73	5.00
4800	14.51	23.90	16.54	8.57	1.38	0.31	4800	34.73	18.22	5.11
5000	14.27	23.90	17.01	8.37	1.40	0.30	5000	34.34	17.76	5.17
5200	14.04	23.93	16.97	8.16	1.43	0.29	5200	34.28	17.47	5.14
5400	13.76	23.84	17.02	7.86	1.44	0.29	5400	33.80	17.24	5.29
5600	13.52	23.85	17.75	7.74	1.48	0.29	5600	33.47	17.04	5.30
6000	12.85	24.00	17.85	7.39	1.58	0.28	5800	33.13	16.56	5.51
6500	11.79	24.11	17.07	7.03	1.77	0.27	6000	33.20	16.12	5.42
7000	10.33	24.36	14.22	6.76	2.07	0.27	6200	33.51	15.56	5.45
7500	8.63	24.34	11.20	6.44	2.37	0.28	6400	33.36	14.98	5.48
8000	6.73	23.85	9.08	6.15	2.59	0.29	6600	32.53	14.79	5.61
8500	4.85	22.94	7.77	5.91	2.69	0.31	6800	32.46	14.52	5.72
9000	3.34	21.76	6.94	5.66	2.60	0.31	7000	33.32	14.46	5.79
10000	1.07	18.53	6.75	5.93	2.28	0.28	7200	33.43	14.12	5.78
12000	-1.22	11.85	7.54	7.16	1.58	0.26	7500	32.64	13.50	5.77
13000	-1.69	7.78	9.23	8.69	1.27	0.33	8000	30.18	12.01	6.34



## Typical Performance Data

### Definitions:

Input Return Loss = -S11 (dB)

Gain(Power Gain) = S21 (dB)

Reverse Isolation = -S12 (dB)

Output Return Loss = -S22 (dB)

TEST CONDITIONS: Icc = 100mA, Vd = 6.03V @Temperature = -45degC

FREQ	Gain	Isolation	Input Return Loss	Output Return Loss	Stability		FREQ	IP3 Output	1dB Comp. Output	Noise Figure
					K	Delta				
(MHz)	(dB)	(dB)	(dB)	(dB)	K	Delta	(MHz)	(dBm)	(dBm)	(dB)
50	25.81	29.75	25.09	16.07	1.07	0.63	50	37.88	21.80	3.65
100	25.78	29.62	24.31	16.12	1.07	0.63	100	37.67	21.91	3.81
200	25.64	29.74	23.99	15.98	1.08	0.61	200	37.77	21.65	3.80
400	25.22	29.48	25.86	13.79	1.08	0.60	400	37.69	21.85	3.87
600	24.61	29.32	24.36	12.60	1.09	0.57	600	37.56	21.54	3.85
800	23.93	29.02	23.39	11.57	1.10	0.54	800	38.00	21.57	3.98
1000	23.20	28.72	22.60	10.88	1.11	0.51	1000	38.36	21.56	3.90
1200	22.44	28.44	22.20	10.21	1.13	0.48	1200	38.39	21.15	3.91
1400	21.72	28.09	21.50	9.61	1.14	0.46	1400	38.26	21.16	3.82
1600	21.02	27.79	20.63	9.29	1.16	0.44	1600	38.68	21.27	3.98
1800	20.36	27.43	20.14	9.00	1.18	0.42	1800	39.96	21.19	4.04
2000	19.76	27.08	19.50	8.82	1.19	0.41	2000	40.16	21.27	3.80
2200	19.19	26.80	19.05	8.77	1.21	0.39	2200	40.22	21.50	3.82
2400	18.67	26.53	18.66	8.75	1.23	0.38	2400	40.36	21.59	3.92
2600	18.21	26.10	17.78	8.73	1.22	0.37	2600	39.93	21.50	3.88
2800	17.74	25.96	17.74	8.85	1.26	0.35	2800	40.07	21.41	3.85
3000	17.40	25.44	17.07	8.81	1.23	0.36	3000	40.53	21.34	3.80
3200	17.06	25.25	16.90	8.92	1.25	0.35	3200	40.68	21.24	3.91
3400	16.73	24.98	16.66	9.07	1.26	0.34	3400	40.90	21.14	3.96
3600	16.43	24.73	16.52	9.00	1.26	0.34	3600	39.77	21.06	4.01
3800	16.17	24.51	16.48	9.10	1.27	0.34	3800	38.27	20.75	3.96
4000	15.94	24.35	16.71	9.11	1.28	0.34	4000	36.92	20.28	4.02
4200	15.68	24.20	17.18	8.95	1.29	0.34	4200	37.85	19.92	4.07
4400	15.42	24.01	17.42	8.74	1.29	0.34	4400	38.86	19.59	4.08
4600	15.26	23.98	17.09	8.58	1.30	0.33	4600	37.94	19.28	4.26
4800	15.03	23.79	17.22	8.24	1.29	0.33	4800	37.78	18.88	4.28
5000	14.84	23.81	17.61	8.01	1.31	0.33	5000	37.09	18.47	4.32
5200	14.66	23.73	17.36	7.82	1.31	0.32	5200	37.47	18.07	4.30
5400	14.46	23.73	17.40	7.52	1.32	0.32	5400	37.24	17.80	4.43
5600	14.25	23.71	17.81	7.45	1.34	0.32	5600	36.27	17.64	4.39
6000	13.75	23.72	18.49	7.06	1.39	0.31	5800	36.45	17.32	4.61
6500	12.80	23.84	18.28	6.50	1.52	0.31	6000	36.22	16.93	4.49
7000	11.46	24.06	14.86	6.07	1.73	0.30	6200	36.27	16.15	4.51
7500	9.80	24.01	11.28	5.79	1.96	0.32	6400	37.27	15.35	4.53
8000	7.96	23.58	9.17	5.66	2.16	0.33	6600	36.34	15.02	4.61
8500	6.12	22.65	7.89	5.52	2.24	0.34	6800	35.42	14.89	4.70
9000	4.54	21.54	6.96	5.19	2.18	0.34	7000	37.18	14.77	4.79
10000	2.08	18.54	6.55	5.29	1.94	0.32	7200	36.90	14.21	4.76
12000	-0.13	11.80	7.47	6.82	1.38	0.30	7500	34.77	13.81	4.71
13000	-0.88	7.88	8.22	7.72	1.12	0.37	8000	32.29	12.76	5.32



## Typical Performance Data

### Definitions:

Input Return Loss = -S11 (dB)

Gain(Power Gain) = S21 (dB)

Reverse Isolation = -S12 (dB)

Output Return Loss = -S22 (dB)

TEST CONDITIONS: Icc = 80mA, Vd=6.01V @Temperature = -45degC

FREQ	Gain	Isolation	Input Return Loss	Output Return Loss	Stability		FREQ	IP3 Output	1dB Comp. Output	Noise Figure
					K	Delta				
(MHz)	(dB)	(dB)	(dB)	(dB)	K	Delta	(MHz)	(dBm)	(dBm)	(dB)
50	25.59	28.77	21.83	18.18	1.04	0.68	50	33.93	19.08	3.63
100	25.52	29.31	21.51	18.21	1.07	0.64	100	33.65	19.07	3.71
200	25.38	29.22	21.34	17.60	1.07	0.63	200	33.73	18.88	3.76
400	24.99	29.36	22.77	14.85	1.09	0.59	400	33.91	18.83	3.88
600	24.40	28.96	22.19	13.35	1.08	0.57	600	34.04	18.91	3.80
800	23.72	28.72	21.55	12.01	1.09	0.54	800	34.70	18.63	3.91
1000	23.00	28.43	21.29	11.14	1.10	0.51	1000	35.08	18.83	3.83
1200	22.28	28.12	20.87	10.39	1.12	0.49	1200	35.26	19.11	3.83
1400	21.57	27.82	20.37	9.80	1.13	0.46	1400	35.33	19.39	3.88
1600	20.87	27.51	19.81	9.41	1.15	0.44	1600	35.66	19.32	3.88
1800	20.23	27.29	19.31	9.13	1.17	0.42	1800	36.63	19.14	3.77
2000	19.65	26.87	18.62	8.89	1.17	0.41	2000	36.78	19.19	3.74
2200	19.08	26.63	18.37	8.79	1.20	0.39	2200	37.15	19.26	3.77
2400	18.57	26.26	17.87	8.72	1.20	0.38	2400	37.50	19.29	3.78
2600	18.10	26.09	17.41	8.81	1.23	0.36	2600	37.85	19.46	3.78
2800	17.70	25.73	17.02	8.81	1.23	0.36	2800	37.80	19.12	3.75
3000	17.35	25.32	16.48	8.78	1.21	0.35	3000	38.13	18.78	3.80
3200	17.02	25.08	16.42	8.97	1.23	0.35	3200	38.32	18.68	3.73
3400	16.70	24.89	16.09	8.92	1.24	0.34	3400	38.28	18.46	3.87
3600	16.43	24.57	15.73	9.07	1.24	0.34	3600	38.09	18.14	3.86
3800	16.14	24.41	15.57	9.22	1.25	0.34	3800	36.82	17.75	3.97
4000	15.89	24.25	15.43	9.16	1.26	0.33	4000	35.78	17.41	3.91
4200	15.63	23.99	15.36	8.97	1.25	0.34	4200	35.71	17.15	4.10
4400	15.34	23.87	15.42	8.70	1.26	0.33	4400	36.18	16.84	3.96
4600	15.12	23.81	15.89	8.46	1.28	0.33	4600	35.75	16.66	4.11
4800	14.84	23.68	16.11	8.25	1.29	0.33	4800	35.61	16.43	4.05
5000	14.66	23.68	16.21	7.97	1.30	0.32	5000	35.10	15.90	4.22
5200	14.43	23.76	16.77	7.79	1.33	0.31	5200	34.79	14.48	4.21
5400	14.22	23.76	17.26	7.60	1.35	0.31	5400	34.92	14.06	4.35
5600	14.03	23.66	18.75	7.42	1.37	0.31	5600	33.92	14.40	4.38
6000	13.52	23.76	18.43	7.15	1.44	0.31	5800	33.41	14.32	4.44
6500	12.81	23.64	17.91	6.97	1.54	0.32	6000	33.70	14.27	4.45
7000	11.51	24.38	14.00	6.23	1.80	0.31	6200	33.47	14.39	4.46
7500	9.63	23.23	12.07	6.30	1.93	0.32	6400	33.87	14.43	4.48
8000	7.85	23.13	9.35	5.87	2.12	0.32	6600	33.44	14.42	4.53
8500	5.90	22.48	8.10	5.83	2.34	0.33	6800	32.86	14.33	4.69
9000	4.38	21.64	6.92	5.52	2.31	0.34	7000	32.71	14.24	4.84
10000	1.97	18.63	6.52	5.69	2.06	0.31	7200	32.52	13.83	4.88
12000	-0.22	11.80	7.20	7.19	1.41	0.30	7500	32.70	13.02	4.93
13000	-1.11	8.12	8.16	7.57	1.13	0.33	8000	31.21	12.90	5.61

## Typical Performance Data

### Definitions:

Input Return Loss = -S11 (dB)

Gain(Power Gain) = S21 (dB)

Reverse Isolation = -S12 (dB)

Output Return Loss = -S22 (dB)

TEST CONDITIONS: Icc = 120mA, Vd = 6.09V @Temperature = -45degC

FREQ	Gain	Isolation	Input Return Loss	Output Return Loss	Stability		FREQ	IP3 Output	1dB Comp. Output	Noise Figure
					K	Delta				
(MHz)	(dB)	(dB)	(dB)	(dB)	K	Delta	(MHz)	(dBm)	(dBm)	(dB)
50	25.96	29.97	27.92	15.12	1.08	0.62	50	40.80	23.04	3.70
100	25.93	29.97	26.63	15.07	1.08	0.62	100	40.64	23.13	3.85
200	25.79	29.80	26.29	15.08	1.07	0.62	200	40.60	22.97	3.85
400	25.35	29.73	28.00	13.20	1.08	0.60	400	40.17	23.10	3.92
600	24.74	29.49	25.89	12.20	1.09	0.57	600	39.64	22.88	3.89
800	24.04	29.25	24.57	11.25	1.10	0.54	800	39.71	22.89	4.03
1000	23.30	28.89	23.57	10.65	1.11	0.51	1000	39.92	22.91	3.95
1200	22.54	28.62	23.03	10.04	1.14	0.48	1200	39.99	22.67	3.96
1400	21.81	28.26	22.13	9.48	1.15	0.46	1400	39.89	22.64	3.88
1600	21.10	27.89	21.23	9.19	1.17	0.44	1600	40.37	22.69	4.02
1800	20.43	27.60	20.72	8.92	1.19	0.42	1800	41.71	22.63	4.09
2000	19.84	27.19	20.02	8.76	1.20	0.41	2000	41.63	22.69	3.88
2200	19.26	26.86	19.57	8.71	1.21	0.40	2200	41.46	22.74	3.91
2400	18.73	26.56	19.17	8.68	1.23	0.38	2400	41.37	22.63	3.98
2600	18.28	26.18	18.26	8.67	1.23	0.37	2600	40.85	22.54	3.97
2800	17.81	26.02	18.25	8.78	1.26	0.36	2800	40.93	22.58	3.95
3000	17.47	25.58	17.56	8.76	1.24	0.36	3000	41.69	22.41	3.90
3200	17.12	25.25	17.38	8.87	1.24	0.35	3200	41.31	22.15	3.99
3400	16.80	25.02	17.17	9.01	1.26	0.35	3400	41.45	21.95	4.03
3600	16.50	24.77	17.02	8.94	1.26	0.34	3600	40.79	21.84	4.09
3800	16.24	24.52	16.98	9.03	1.26	0.34	3800	38.88	21.49	4.03
4000	16.01	24.41	17.17	9.04	1.28	0.34	4000	38.04	20.93	4.11
4200	15.76	24.23	17.67	8.86	1.28	0.34	4200	39.16	20.50	4.16
4400	15.50	24.01	17.91	8.63	1.28	0.34	4400	40.97	20.19	4.18
4600	15.34	23.92	17.56	8.45	1.28	0.34	4600	39.81	19.88	4.33
4800	15.11	23.80	17.72	8.12	1.28	0.34	4800	40.16	19.47	4.36
5000	14.94	23.81	18.13	7.88	1.30	0.33	5000	39.78	19.01	4.41
5200	14.76	23.77	17.85	7.67	1.30	0.33	5200	39.55	18.62	4.38
5400	14.58	23.70	17.90	7.36	1.30	0.33	5400	39.96	18.38	4.53
5600	14.37	23.72	18.32	7.28	1.32	0.32	5600	38.58	18.26	4.49
6000	13.89	23.68	18.99	6.85	1.36	0.32	5800	39.22	17.89	4.73
6500	12.97	23.76	18.73	6.27	1.47	0.31	6000	39.92	17.47	4.62
7000	11.65	23.95	15.05	5.83	1.66	0.32	6200	40.97	16.87	4.66
7500	9.99	23.94	11.35	5.56	1.88	0.33	6400	42.99	16.08	4.68
8000	8.15	23.57	9.24	5.43	2.09	0.34	6600	39.61	15.49	4.79
8500	6.30	22.62	7.93	5.32	2.17	0.34	6800	39.90	15.36	4.85
9000	4.70	21.49	6.99	5.02	2.11	0.35	7000	43.22	15.26	4.92
10000	2.24	18.48	6.58	5.13	1.88	0.32	7200	39.15	14.82	4.89
12000	0.00	11.74	7.54	6.72	1.36	0.30	7500	35.85	14.27	4.87
13000	-0.76	7.83	8.28	7.63	1.10	0.38	8000	32.59	13.25	5.49

## Typical Performance Data

### Definitions:

Input Return Loss = -S11 (dB)

Gain(Power Gain) = S21 (dB)

Reverse Isolation = -S12 (dB)

Output Return Loss = -S22 (dB)

TEST CONDITIONS: Icc = 100mA, Vd = 5.56V @Temperature = +85degC

FREQ	Gain	Isolation	Input Return Loss	Output Return Loss	Stability		FREQ	IP3 Output	1dB Comp. Output	Noise Figure
(MHz)	(dB)	(dB)	(dB)	(dB)	K	Delta	(MHz)	(dBm)	(dBm)	(dB)
50	25.54	29.58	25.38	16.87	1.08	0.62	50	37.33	21.73	4.43
100	25.50	29.41	25.77	16.32	1.07	0.63	100	37.35	21.81	4.59
200	25.35	29.33	27.16	15.52	1.08	0.62	200	37.59	21.65	4.60
400	24.89	29.44	24.27	14.33	1.09	0.58	400	36.96	21.71	4.71
600	24.25	29.12	23.07	12.94	1.10	0.56	600	36.51	21.39	4.71
800	23.52	28.90	22.14	11.75	1.11	0.52	800	36.72	21.36	4.88
1000	22.75	28.61	21.22	10.95	1.13	0.49	1000	36.70	21.40	4.82
1200	21.96	28.31	20.60	10.29	1.15	0.46	1200	36.39	21.00	4.84
1400	21.22	27.98	19.90	9.75	1.17	0.43	1400	35.91	21.03	4.79
1600	20.49	27.64	19.26	9.37	1.19	0.41	1600	36.09	21.06	4.92
1800	19.80	27.38	18.67	9.11	1.21	0.39	1800	36.24	20.98	4.99
2000	19.17	26.99	17.97	8.93	1.22	0.37	2000	35.92	20.96	4.80
2200	18.57	26.77	17.43	8.91	1.26	0.35	2200	35.42	20.98	4.89
2400	18.04	26.40	16.97	8.93	1.27	0.34	2400	35.24	20.90	4.98
2600	17.56	26.08	16.27	8.93	1.28	0.33	2600	34.65	20.81	4.97
2800	17.05	25.88	16.21	9.09	1.32	0.32	2800	34.65	20.64	4.92
3000	16.67	25.47	15.59	9.05	1.30	0.32	3000	34.51	20.41	4.93
3200	16.28	25.28	15.34	9.18	1.33	0.31	3200	34.19	20.08	5.01
3400	15.92	25.04	15.05	9.34	1.35	0.30	3400	33.98	19.79	5.11
3600	15.58	24.82	14.82	9.45	1.36	0.29	3600	33.51	19.50	5.21
3800	15.25	24.58	14.81	9.58	1.38	0.29	3800	32.65	19.03	5.14
4000	14.98	24.42	14.71	9.67	1.39	0.29	4000	32.13	18.40	5.22
4200	14.67	24.31	15.02	9.67	1.43	0.28	4200	31.94	18.01	5.26
4400	14.36	24.24	15.17	9.62	1.46	0.28	4400	31.76	17.78	5.31
4600	14.11	24.11	15.20	9.46	1.48	0.28	4600	31.27	17.37	5.48
4800	13.80	24.07	15.30	9.21	1.51	0.27	4800	30.95	16.84	5.61
5000	13.51	24.08	15.72	9.04	1.56	0.27	5000	30.70	16.42	5.64
5200	13.20	24.16	15.59	8.86	1.61	0.26	5200	30.48	16.14	5.64
5400	12.87	24.09	15.73	8.62	1.64	0.26	5400	29.92	15.88	5.75
5600	12.55	24.16	16.26	8.56	1.71	0.25	5600	29.61	15.61	5.80
6000	11.75	24.33	16.65	8.35	1.89	0.24	5800	29.44	15.12	6.04
6500	10.56	24.50	16.19	8.18	2.18	0.23	6000	29.38	14.72	5.99
7000	9.05	24.71	13.75	7.98	2.58	0.23	6200	29.32	14.23	6.00
7500	7.33	24.67	11.10	7.61	2.96	0.24	6400	29.21	13.85	6.02
8000	5.44	24.13	8.98	7.08	3.19	0.26	6600	29.00	13.52	6.12
8500	3.58	23.25	7.60	6.58	3.28	0.27	6800	28.85	13.43	6.23
9000	2.11	22.01	6.82	6.24	3.13	0.28	7000	28.62	13.32	6.36
10000	0.04	18.65	6.78	6.63	2.69	0.24	7200	28.77	12.95	6.35
12000	-2.32	12.04	7.50	7.45	1.83	0.24	7500	28.03	12.56	6.34
13000	-2.60	7.89	9.53	9.21	1.42	0.29	8000	26.61	11.02	6.87

## Typical Performance Data

### Definitions:

Input Return Loss = -S11 (dB)

Gain(Power Gain) = S21 (dB)

Reverse Isolation = -S12 (dB)

Output Return Loss = -S22 (dB)

TEST CONDITIONS: Icc = 80mA, Vd=5.54V @Temperature = +85degC

FREQ	Gain	Isolation	Input Return Loss	Output Return Loss	Stability		FREQ	IP3 Output	1dB Comp. Output	Noise Figure
(MHz)	(dB)	(dB)	(dB)	(dB)	K	Delta	(MHz)	(dBm)	(dBm)	(dB)
50	25.27	29.19	21.34	19.43	1.08	0.63	50	33.74	19.42	4.46
100	25.19	29.34	22.03	18.68	1.09	0.61	100	33.65	19.53	4.57
200	25.04	28.96	22.85	17.40	1.08	0.63	200	33.82	19.42	4.58
400	24.60	28.96	21.39	15.50	1.09	0.59	400	33.56	19.10	4.76
600	23.98	28.81	20.71	13.72	1.10	0.55	600	33.52	19.16	4.71
800	23.27	28.46	20.24	12.25	1.10	0.53	800	34.04	18.88	4.83
1000	22.53	28.27	19.77	11.30	1.12	0.49	1000	34.30	18.97	4.78
1200	21.78	28.02	19.45	10.51	1.14	0.46	1200	34.25	19.20	4.80
1400	21.04	27.65	18.90	9.92	1.15	0.44	1400	33.98	19.31	4.87
1600	20.32	27.42	18.48	9.51	1.18	0.41	1600	34.26	19.19	4.89
1800	19.66	27.11	17.82	9.22	1.20	0.39	1800	34.73	18.94	4.77
2000	19.06	26.84	17.18	9.00	1.21	0.37	2000	34.43	18.88	4.74
2200	18.47	26.53	16.65	8.97	1.23	0.35	2200	34.32	18.77	4.81
2400	17.94	26.22	16.07	8.94	1.25	0.34	2400	34.01	18.65	4.85
2600	17.47	25.90	15.53	9.03	1.26	0.33	2600	33.81	18.40	4.87
2800	17.01	25.69	15.20	9.05	1.28	0.32	2800	33.62	18.00	4.87
3000	16.61	25.34	14.71	9.04	1.28	0.31	3000	33.54	17.44	4.91
3200	16.22	25.15	14.50	9.24	1.31	0.30	3200	33.22	17.19	4.86
3400	15.88	24.90	14.26	9.32	1.32	0.30	3400	33.00	16.94	5.03
3600	15.54	24.66	14.20	9.46	1.34	0.29	3600	32.56	16.57	5.09
3800	15.22	24.54	14.15	9.63	1.37	0.29	3800	31.76	15.99	5.20
4000	14.93	24.37	14.07	9.72	1.39	0.28	4000	31.26	15.57	5.14
4200	14.60	24.16	14.21	9.70	1.41	0.28	4200	31.00	15.34	5.34
4400	14.29	24.05	14.42	9.63	1.44	0.28	4400	30.88	15.07	5.24
4600	13.97	24.01	14.65	9.48	1.48	0.28	4600	30.43	14.83	5.42
4800	13.64	23.94	14.74	9.29	1.51	0.27	4800	30.20	14.57	5.42
5000	13.35	24.02	14.78	9.12	1.56	0.26	5000	29.98	13.99	5.60
5200	13.02	24.10	14.88	8.93	1.62	0.26	5200	29.64	12.64	5.58
5400	12.70	24.17	15.18	8.83	1.69	0.25	5400	29.29	12.46	5.73
5600	12.37	24.28	15.64	8.78	1.77	0.24	5600	28.87	12.90	5.82
6000	11.60	24.47	16.06	8.51	1.95	0.23	5800	28.72	12.88	5.87
6500	10.50	24.56	16.69	8.57	2.24	0.22	6000	28.55	12.85	5.98
7000	9.08	25.20	13.61	8.21	2.73	0.22	6200	28.54	12.96	6.01
7500	7.23	24.34	11.21	8.12	2.96	0.24	6400	28.22	13.01	6.04
8000	5.42	24.12	8.89	7.41	3.24	0.25	6600	28.06	13.02	6.15
8500	3.55	23.17	7.85	6.87	3.35	0.26	6800	27.75	12.98	6.28
9000	1.94	22.14	7.24	6.58	3.40	0.27	7000	27.71	12.92	6.41
10000	-0.16	18.75	7.04	7.01	2.90	0.24	7200	27.19	12.45	6.49
12000	-2.30	11.93	7.67	7.59	1.83	0.23	7500	27.63	11.64	6.58
13000	-2.79	8.08	9.78	8.88	1.46	0.27	8000	26.29	10.57	7.20

## Typical Performance Data

### Definitions:

Input Return Loss = -S11 (dB)

Gain(Power Gain) = S21 (dB)

Reverse Isolation = -S12 (dB)

Output Return Loss = -S22 (dB)

TEST CONDITIONS: Icc = 120mA, Vd = 5.62V @Temperature = +85degC

FREQ	Gain	Isolation	Input Return Loss	Output Return Loss	Stability		FREQ	IP3 Output	1dB Comp. Output	Noise Figure
					K	Delta				
(MHz)	(dB)	(dB)	(dB)	(dB)	K	Delta	(MHz)	(dBm)	(dBm)	(dB)
50	25.72	29.34	28.39	15.50	1.06	0.65	50	39.92	22.57	4.52
100	25.68	29.56	29.19	15.09	1.07	0.63	100	40.11	22.64	4.73
200	25.52	29.65	31.19	14.43	1.08	0.62	200	40.20	22.47	4.69
400	25.04	29.61	26.51	13.60	1.09	0.58	400	39.15	22.55	4.80
600	24.39	29.30	24.73	12.45	1.10	0.56	600	38.17	22.20	4.80
800	23.65	29.16	23.41	11.42	1.12	0.51	800	37.80	22.20	5.00
1000	22.86	28.85	22.26	10.70	1.14	0.48	1000	37.54	22.25	4.90
1200	22.07	28.46	21.50	10.10	1.16	0.46	1200	37.14	22.03	4.95
1400	21.31	28.16	20.66	9.61	1.18	0.43	1400	36.63	21.99	4.89
1600	20.57	27.82	19.96	9.27	1.20	0.41	1600	36.69	21.98	5.03
1800	19.88	27.52	19.35	9.03	1.22	0.39	1800	36.61	21.83	5.12
2000	19.25	27.15	18.57	8.85	1.24	0.37	2000	36.25	21.78	4.93
2200	18.65	26.83	17.98	8.86	1.26	0.36	2200	35.77	21.64	5.00
2400	18.11	26.52	17.47	8.88	1.28	0.34	2400	35.50	21.50	5.09
2600	17.63	26.15	16.76	8.87	1.28	0.34	2600	34.94	21.40	5.10
2800	17.12	25.97	16.70	9.04	1.33	0.32	2800	34.77	21.26	5.09
3000	16.74	25.55	16.02	9.00	1.31	0.32	3000	34.72	21.05	5.06
3200	16.34	25.36	15.76	9.12	1.34	0.31	3200	34.39	20.66	5.17
3400	15.99	25.10	15.49	9.25	1.35	0.30	3400	34.27	20.33	5.24
3600	15.65	24.81	15.24	9.38	1.36	0.30	3600	33.63	20.03	5.35
3800	15.33	24.62	15.21	9.47	1.38	0.30	3800	32.92	19.57	5.33
4000	15.07	24.41	15.08	9.53	1.38	0.29	4000	32.28	18.92	5.40
4200	14.74	24.29	15.41	9.52	1.42	0.29	4200	32.07	18.50	5.44
4400	14.45	24.24	15.54	9.45	1.45	0.29	4400	31.92	18.27	5.48
4600	14.20	24.13	15.57	9.28	1.47	0.28	4600	31.49	17.88	5.64
4800	13.89	24.01	15.67	9.03	1.49	0.28	4800	31.14	17.35	5.80
5000	13.62	24.06	16.05	8.85	1.53	0.27	5000	30.90	16.93	5.80
5200	13.32	24.12	15.92	8.64	1.57	0.27	5200	30.60	16.59	5.82
5400	12.99	24.05	16.03	8.39	1.61	0.26	5400	29.96	16.42	5.97
5600	12.67	24.11	16.57	8.31	1.67	0.26	5600	29.74	16.17	6.02
6000	11.90	24.27	16.95	8.09	1.84	0.24	5800	29.52	14.82	6.23
6500	10.71	24.47	16.40	7.88	2.12	0.24	6000	29.29	15.24	6.19
7000	9.21	24.66	13.85	7.68	2.50	0.23	6200	29.47	14.85	6.21
7500	7.48	24.62	11.15	7.33	2.87	0.24	6400	28.95	14.52	6.23
8000	5.58	24.09	9.00	6.84	3.10	0.26	6600	28.93	13.89	6.32
8500	3.71	23.24	7.62	6.37	3.20	0.28	6800	28.60	13.81	6.48
9000	2.22	21.95	6.84	6.07	3.04	0.29	7000	28.57	13.74	6.63
10000	0.15	18.60	6.81	6.47	2.62	0.25	7200	28.61	13.38	6.62
12000	-2.23	11.96	7.53	7.36	1.79	0.24	7500	27.67	12.94	6.63
13000	-2.52	7.85	9.56	9.15	1.41	0.29	8000	27.18	11.34	7.17

## Typical Performance Curves

### GAIN vs. TEMPERATURE

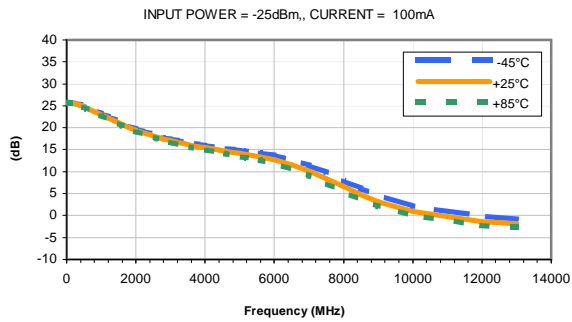

### GAIN vs. CURRENT

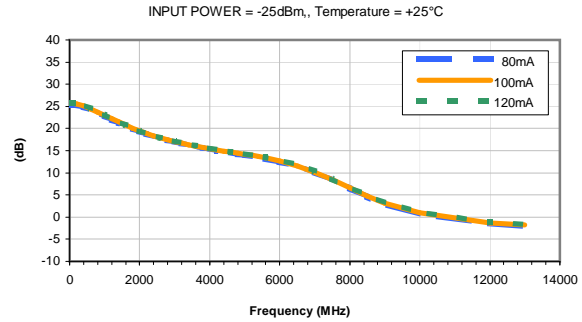

### ISOLATION vs. TEMPERATURE

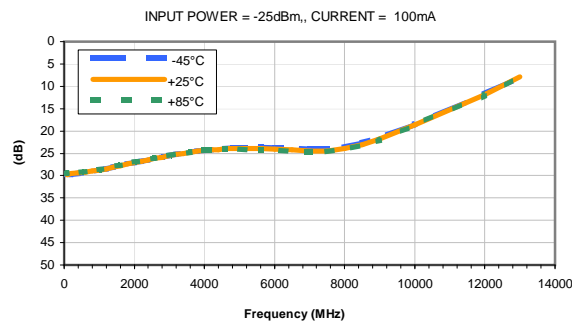

### ISOLATION vs. CURRENT

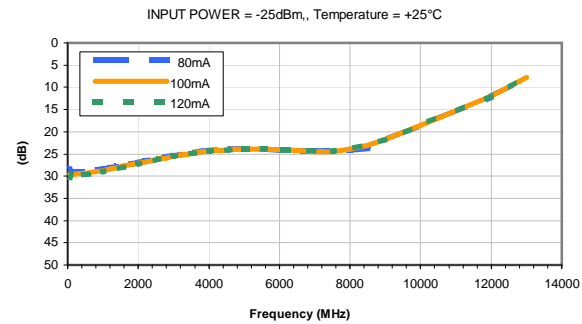

### INPUT RETURN LOSS vs. TEMPERATURE

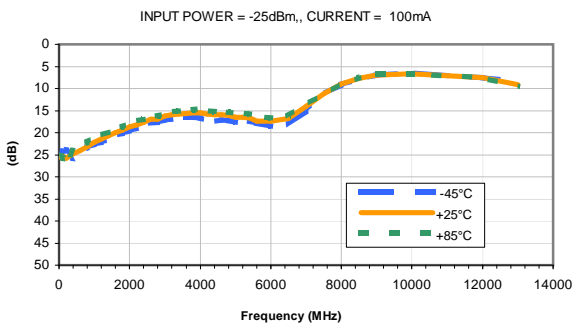

### INPUT RETURN LOSS vs. CURRENT

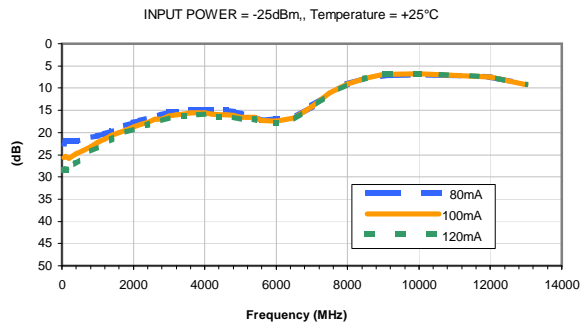

### OUTPUT RETURN LOSS vs. TEMPERATURE

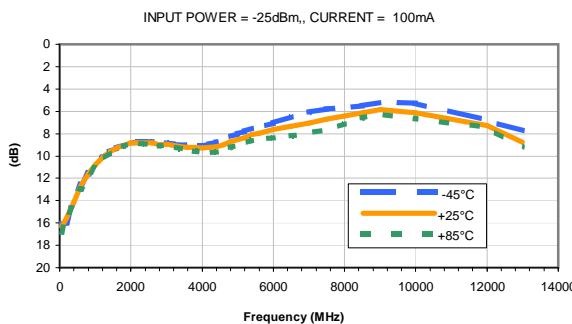

### OUTPUT RETURN LOSS vs. CURRENT

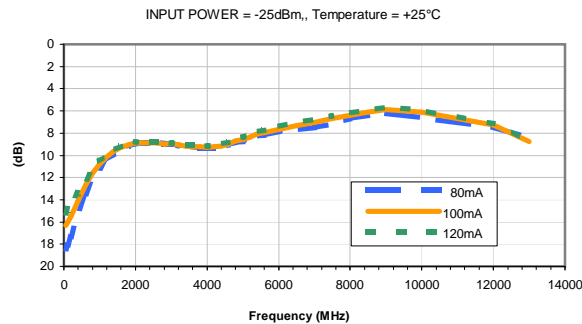

## Typical Performance Curves

**OUTPUT IP3 vs. TEMPERATURE**

INPUT POWER = -25dBm, CURRENT = 100mA

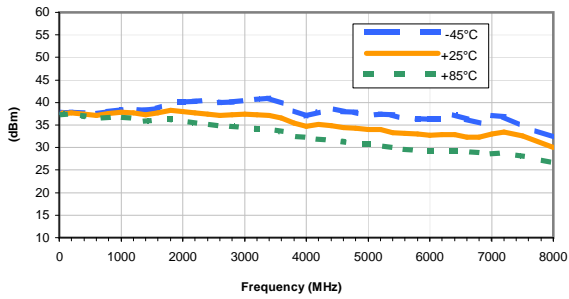

**OUTPUT IP3 vs. CURRENT**

INPUT POWER = -25dBm, Temperature = +25°C

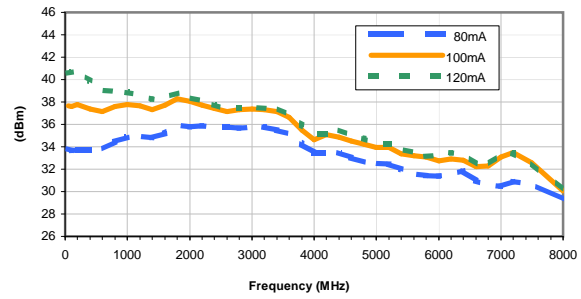

**OUTPUT POWER at 1dB Compression vs. TEMPERATURE**

CURRENT = 100mA

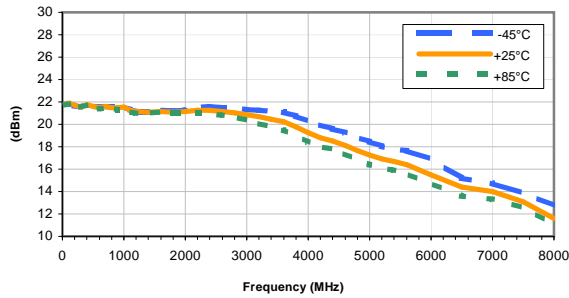

**OUTPUT POWER at 1dB Compression vs. CURRENT**

Temperature = +25°C

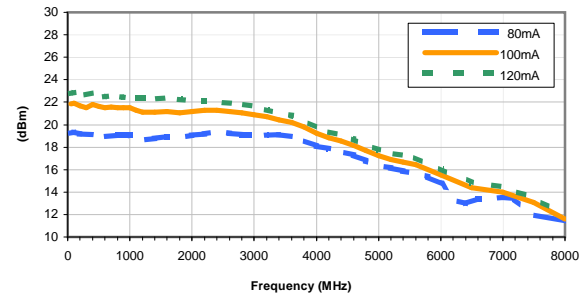

**Noise Figure vs. TEMPERATURE**

CURRENT = 100mA

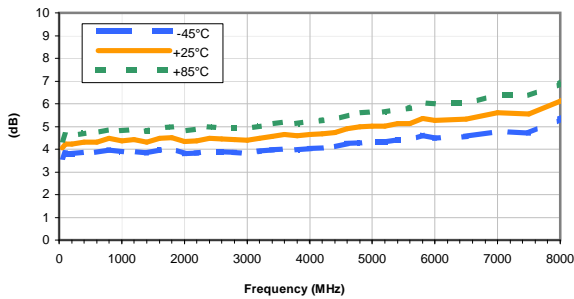

**Noise Figure vs. CURRENT**

Temperature = +25°C

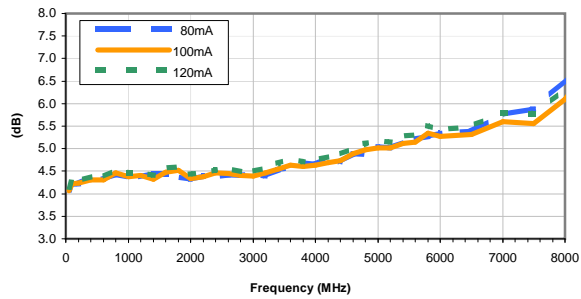



## Typical Performance Curves

**GAIN vs. TEMPERATURE**

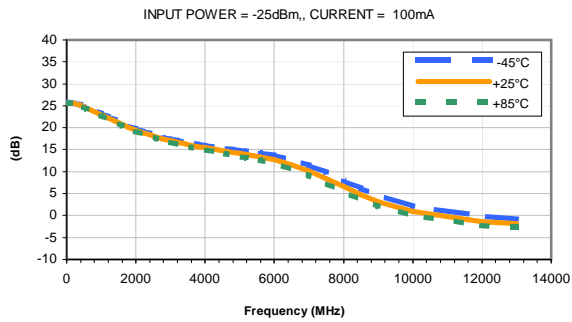

**GAIN vs. CURRENT**

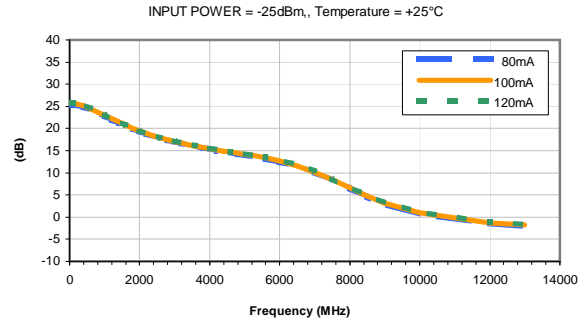

**ISOLATION vs. TEMPERATURE**

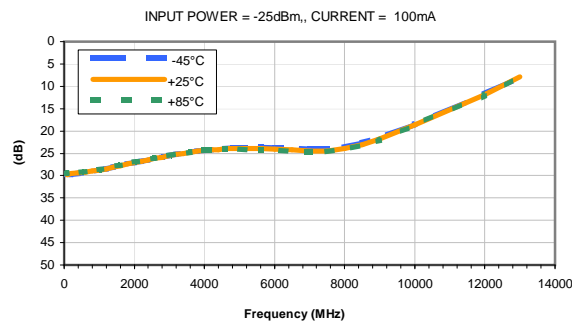

**ISOLATION vs. CURRENT**

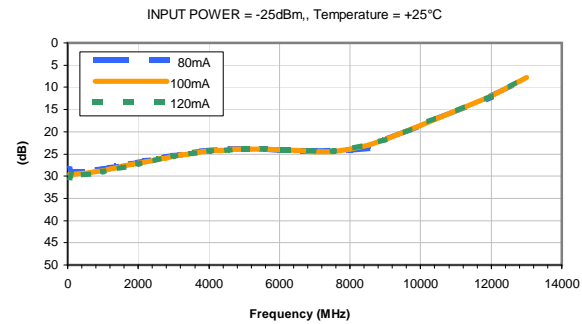

**INPUT RETURN LOSS vs. TEMPERATURE**

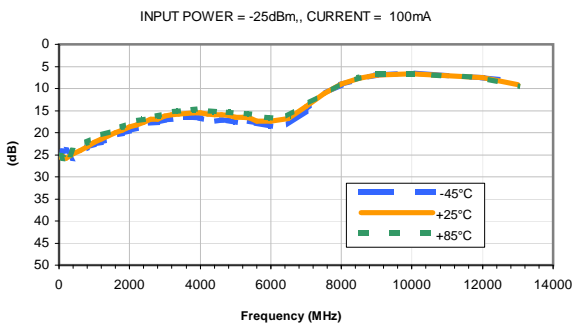

**INPUT RETURN LOSS vs. CURRENT**

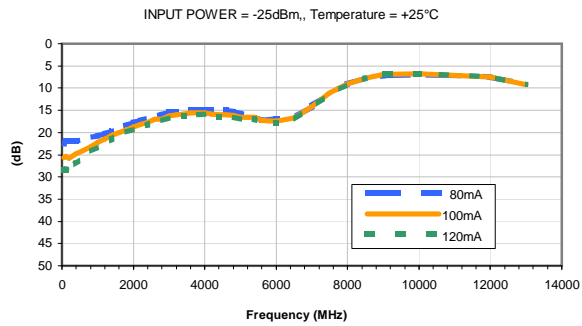

**OUTPUT RETURN LOSS vs. TEMPERATURE**

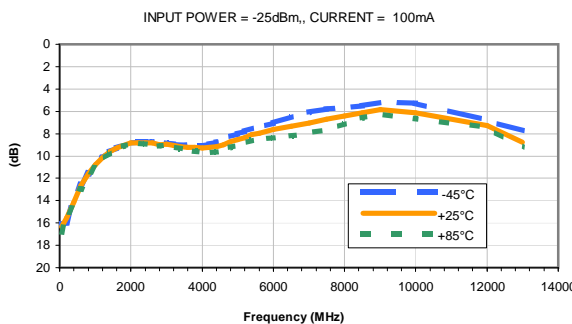

**OUTPUT RETURN LOSS vs. CURRENT**

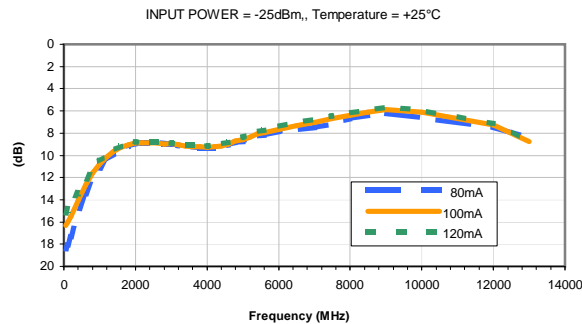

## Typical Performance Curves

**OUTPUT IP3 vs. TEMPERATURE**

INPUT POWER = -25dBm, CURRENT = 100mA

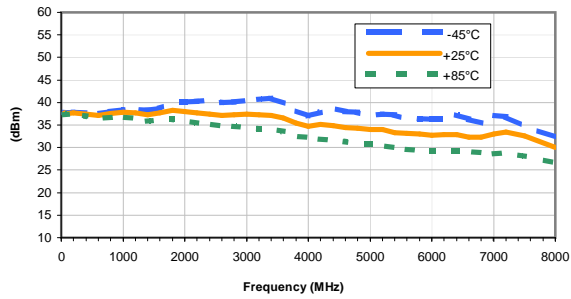

**OUTPUT IP3 vs. CURRENT**

INPUT POWER = -25dBm, Temperature = +25°C

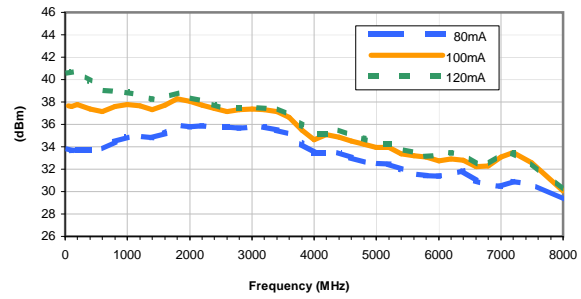

**OUTPUT POWER at 1dB Compression vs. TEMPERATURE**

CURRENT = 100mA

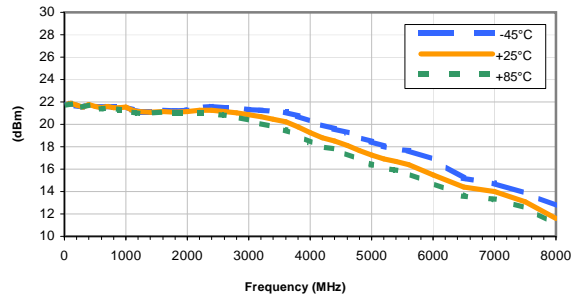

**OUTPUT POWER at 1dB Compression vs. CURRENT**

Temperature = +25°C

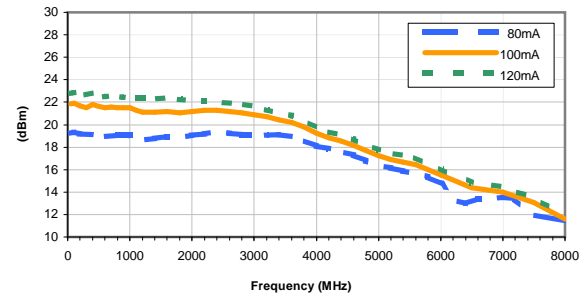

**Noise Figure vs. TEMPERATURE**

CURRENT = 100mA

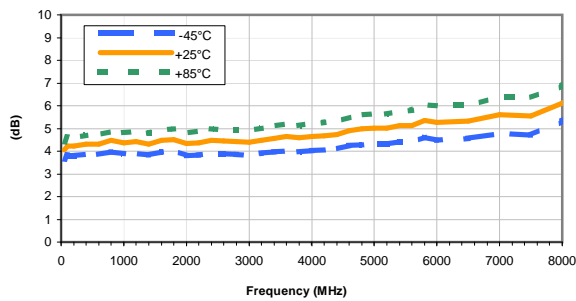

**Noise Figure vs. CURRENT**

Temperature = +25°C

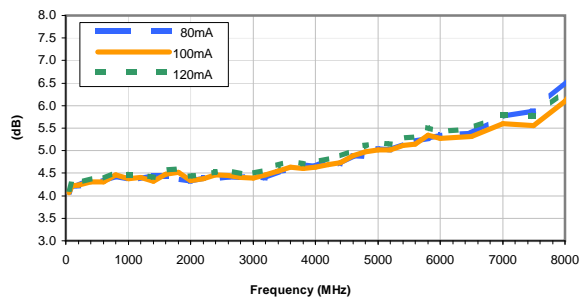

### Outline Dimensions

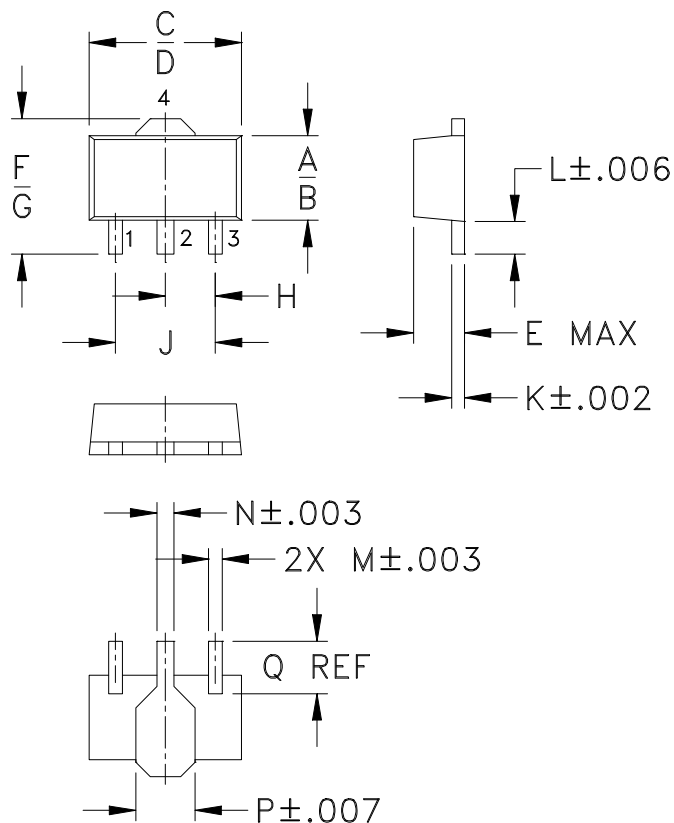

### PCB Land Pattern

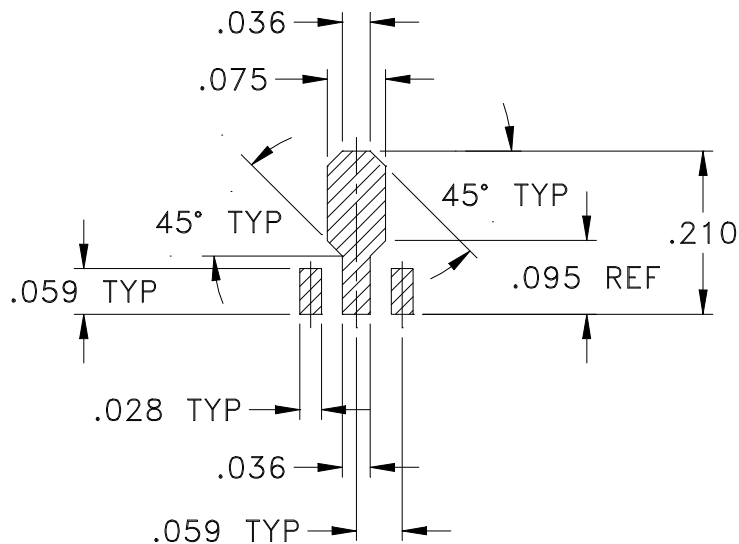

Suggested Layout,  
Tolerance to be within  $\pm .002$

CASE #	A	B	C	D	E	F	G	H	J	K	L	M
DF782	.102 (2.59)	.090 (2.29)	.181 (4.60)	.173 (4.39)	.063 (1.60)	.167 (4.24)	.155 (3.94)	.059 (1.50)	.118 (3.00)	.015 (0.38)	.041 (1.04)	.016 (0.41)

CASE #	N	P	Q	WT. GRAM
DF782	.019 (0.48)	.065 (1.65)	.062 (1.57)	.2

Dimensions are in inches (mm). Tolerances: 2 Pl.  $\pm .01$ ; 3Pl.  $\pm .005$

#### Notes:

- Case material: Plastic.
- Termination finish:  
For RoHS Case Styles: Tin-Silver alloy plate over Nickel barrier or Matte-Tin.  
All models, (+) suffix. See model Data sheet.  
For RoHS-5 Case Styles: Tin-Lead plate. All models, no (+) suffix.



INTERNET <http://www.minicircuits.com>

P.O. Box 350166, Brooklyn, New York 11235-0003 (718) 934-4500 Fax (718) 332-4661

Distribution Centers NORTH AMERICA 800-654-7949 • 417-335-5935 • Fax 417-335-5945 • EUROPE 44-1252-832600 • Fax 44-1252-837010

Mini-Circuits ISO 9001 & ISO 14001 Certified

# Tape & Reel Packaging TR-F55

## DEVICE ORIENTATION IN T&R

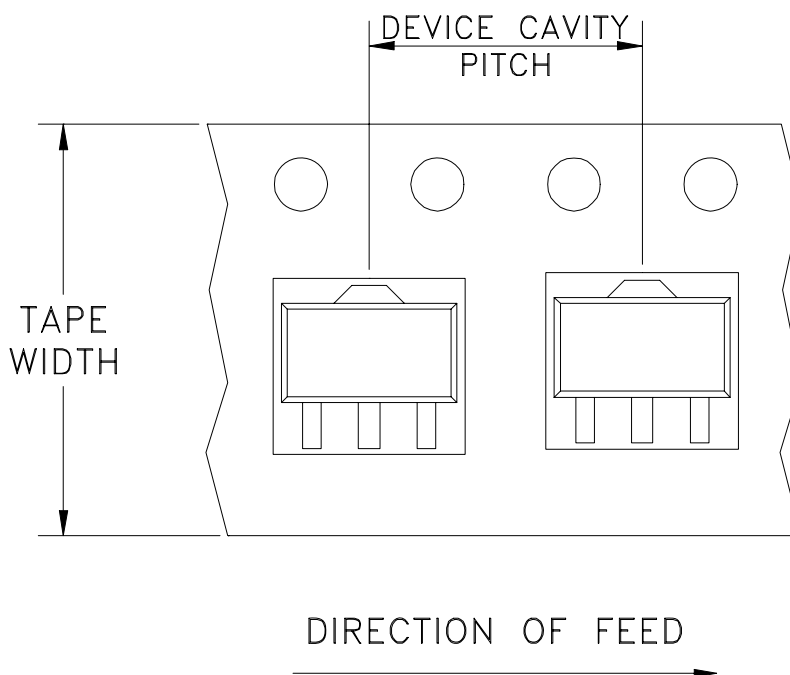

Tape Width, mm	Device Cavity Pitch, mm	Reel Size, inches	Devices per Reel	
12	8	7	Small quantity standard (see note)	20
				50
				100
				200
				500
			Standard	1000

Note: Please consult individual model data sheet to determine device per reel availability.

Mini-Circuits carrier tape materials provide protection from ESD (Electro-Static Discharge) during handling and transportation. Tapes are static dissipative and comply with industry standards EIA-481/EIA-541.

Go to: [www.minicircuits.com/pages/pdfs/tape.pdf](http://www.minicircuits.com/pages/pdfs/tape.pdf)



INTERNET <http://www.minicircuits.com>

P.O. Box 350166, Brooklyn, New York 11235-0003 (718) 934-4500 Fax (718) 332-4661

Distribution Centers NORTH AMERICA 800-654-7949 • 417-335-5935 • Fax 417-335-5945 • EUROPE 44-1252-832600 • Fax 44-1252-837010

Mini-Circuits ISO 9001 & ISO 14001 Certified

THIRD ANGLE PROJECTION

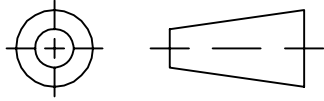

REVISIONS

REV	ECN No.	DESCRIPTION	DATE	DR	AUTH
A	M76190	CHANGED DISCRIPTION	04/01	GF	CT
B	M82575	UPDATED DRAWING	08/05/02	AV	LC
C	M102713	ADDED NOTE 2 & "...WITH SMOBC"	01/17/06	MMG	IL
D	M108434	UPDATED DRAWING PER TB-409+	11/14/06	PW	IG

SUGGESTED MOUNTING CONFIGURATION  
FOR DF782 CASE STYLE, "mz" PIN CONNECTION

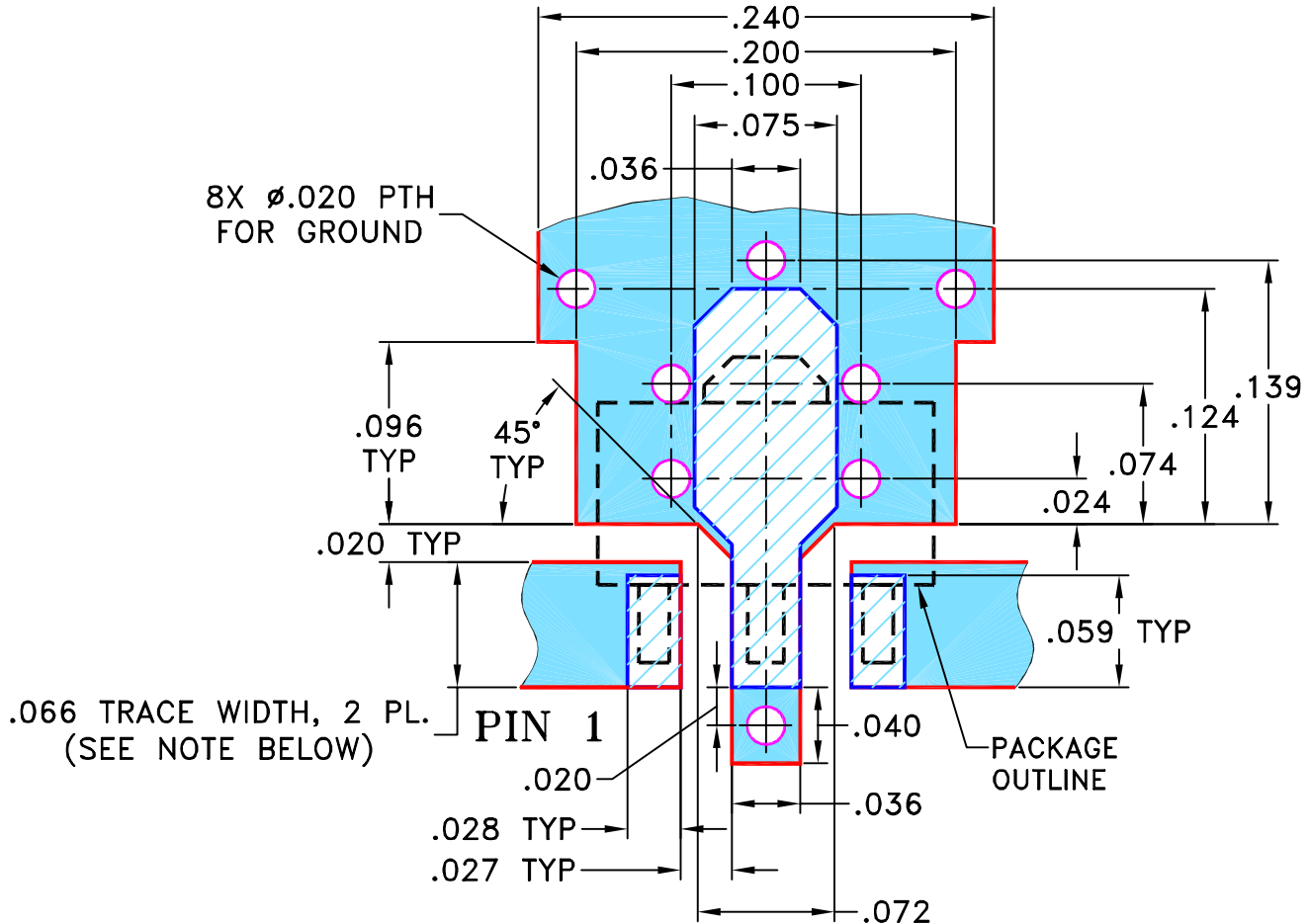

- NOTES:** 1. TRACE WIDTH IS SHOWN FOR ROGERS R04350B WITH DIELECTRIC THICKNESS .030" ± .002"; COPPER: 1/2 OZ. EACH SIDE. FOR OTHER MATERIALS TRACE WIDTH MAY NEED TO BE MODIFIED.  
2. BOTTOM SIDE OF THE PCB IS CONTINUOUS GROUND PLANE.



DENOTES PCB COPPER LAYOUT WITH SMOBC (SOLDER MASK OVER BARE COPPER)



DENOTES COPPER LAND PATTERN FREE OF SOLDER MASK

UNLESS OTHERWISE SPECIFIED

INITIALS

DATE

DIMENSIONS ARE IN INCHES

DRAWN

AV

01/15/01

TOLERANCES ON:

CHECKED

YB

01/23/01

2 PL DECIMALS ± .005

APPROVED

DB

01/23/01

3 PL DECIMALS ±

ANGLES ±

FRACTIONS ±

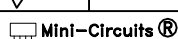

THIS DOCUMENT AND ITS CONTENTS ARE THE PROPERTY OF MINI-CIRCUITS. EXCEPT FOR USE EXPRESSLY GRANTED, IN WRITING, TO ITS VENDORS, VENDEE AND THE UNITED STATES GOVERNMENT, MINI-CIRCUITS RESERVES ALL PROPRIETARY DESIGN, USE, MANUFACTURING AND REPRODUCTION RIGHTS THERETO. THESE CONTENTS SHALL NOT BE USED, DUPLICATED OR DISCLOSED TO ANY OUTSIDE PARTY, IN WHOLE OR IN PART, WITHOUT WRITTEN PERMISSION OF MINI-CIRCUITS.



Mini-Circuits®

13 Neptune Avenue  
Brooklyn NY 11235

PL, mz, DF782, GALI, TB-409-XXX+

SIZE

CODE IDENT

DRAWING NO:

REV:

A

15542

98-PL-019

D

FILE:

98PL019

SCALE:

10:1

SHEET:

1 OF 1

# Evaluation Board and Circuit

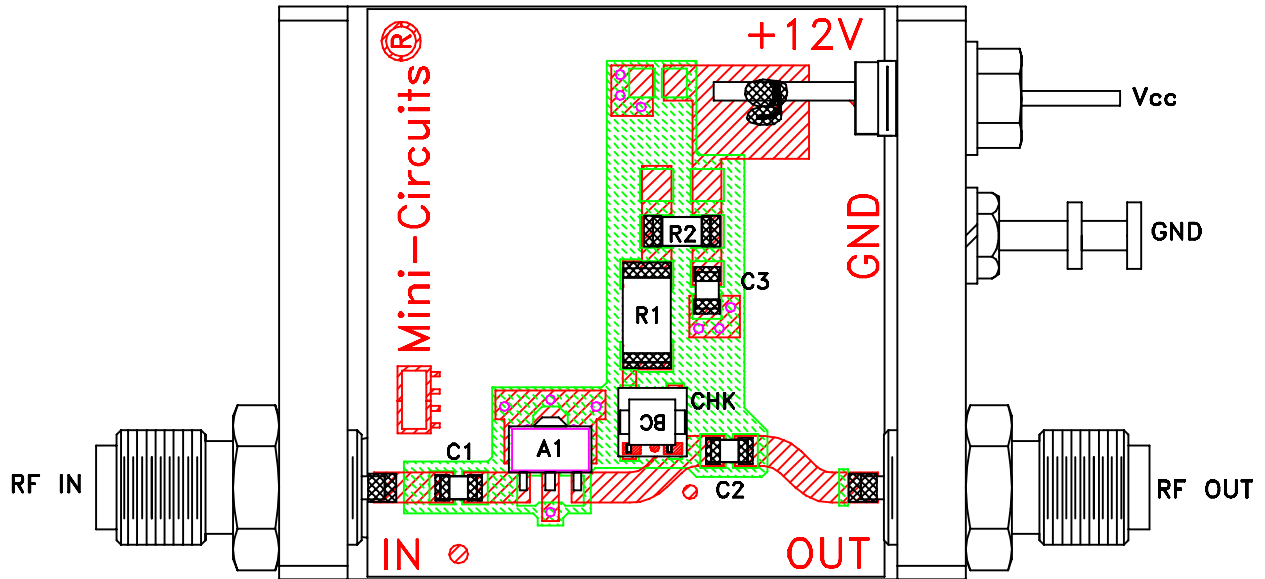

TB-409-84+

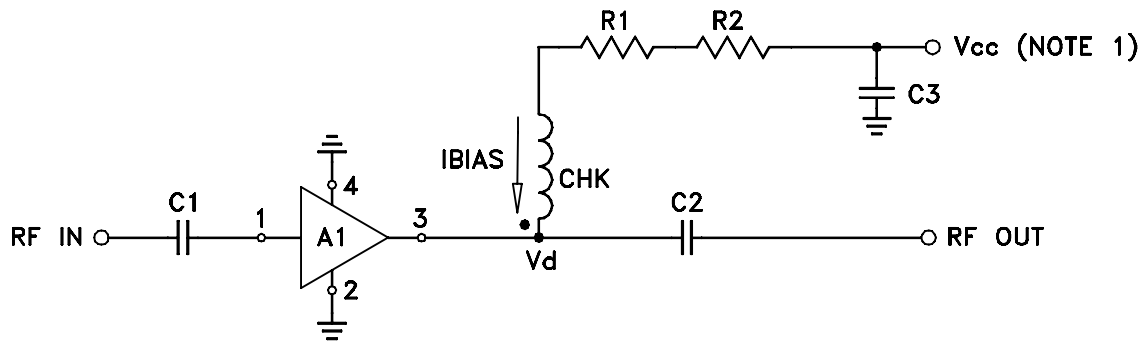

COMPONENT	VALUE
A1	Gali-84(+)
C1 (NOTE 4)	2400 pF
C2 (NOTE 4)	2400 pF
C3 (bypass)	0.1 uF
R1	47.5 Ohms, 0.75W
R2	15 Ohms, 0.25W
CHK	Mini-Circuits TCCH-80+

Schematic Diagram

**NOTE:**

1. Vcc voltage:  $+12 \pm 0.2V$ .
2. SMA Female connectors.
3. PCB material: Rogers R04350 or equivalent, dielectric constant=3.5, dielectric thickness=.030 inch.
4. Capacitors, C1 & C2 should be free of resonance up to the highest frequency specified.

Mini-Circuits®

All Mini-Circuits products are manufactured under exacting quality assurance and control standards, and are capable of meeting published specifications after being subjected to any or all of the following physical and environmental test.

Specification	Test/Inspection Condition	Reference/Spec
Operating Temperature	-45° to 85°C or -40° to 85°C Ambient Environment	Individual Model Data Sheet
Storage Temperature	-65° to 150° C Ambient Environment	Individual Model Data Sheet
Thermal Shock	-55° to 100°C, 100 cycles	MIL-STD-202, Method 107, Condition A-3, except +100°C
Mechanical Shock	1.5Kg, 0.5 ms, 5 shock pulses, Y1 direction only	MIL-STD-883, Method 2002, Condition B, except Y1 direction only
Vibration (Variable Frequency)	50g peak	MIL-STD-883, Method 2007, Condition B
Autoclave	15 psig, 100% RH, 121°C, 96 hours	JESD22-A102, Condition C
HAST	130°C, 85% RH, 96 hours	JESD22-A110
Solderability	10X Magnification	J-STD-002, Para 4.2.5, Test S, 95% Coverage
Solder Reflow Heat	Sn-Pb Eutetic Process: 240°C peak Pb-Free Process: 260°C peak	J-STD-020, Table 4-1, 4-2 and 5-2; Figure 5-1
Moisture Sensitivity: Level 1	Bake at 125°C for 24 hours Soak at 85°C/85% RH for 168 hours, Reflow 3 cycles at 260°C peak	J-STD-020
Marking Resistance to Solvents	Isopropyl alcohol + mineral spirits at 25°C; terpene defluxer at 25°C; distilled water + proylene glycol monomethyl ether +	MIL-STD-202, Method 215





All Mini-Circuits products are manufactured under exacting quality assurance and control standards, and are capable of meeting published specifications after being subjected to any or all of the following physical and environmental test.

Specification	Test/Inspection Condition	Reference/Spec
	monoethanolamine at 63°C to 70°C	