

# High IP3 Frequency Mixer

## ADE-12H+

### Level 17 (LO Power +17 dBm) 500 to 1200 MHz



Generic photo used for illustration purposes only

CASE STYLE: CD542

**+RoHS Compliant**

The +Suffix identifies RoHS Compliance. See our web site for RoHS Compliance methodologies and qualifications



Available Tape and Reel at no extra cost

Reel Size	Devices/Reel
7"	20, 50, 100, 200
13"	500, 1000

### Maximum Ratings

Operating Temperature	-40°C to 85°C
Storage Temperature	-55°C to 100°C
RF Power	200mW
IF Current	40mA

### Pin Connections

LO	6
RF	4
IF	3
GROUND	1,2,5

### Features

- low conversion loss, 6.7 dB typ.
- good L-R isolation, 34 dB typ.
- high IP3, 28 dBm typ.
- low profile package
- aqueous washable
- protected by U.S. Patent 6,133,525

### Applications

- cellular

### Outline Drawing

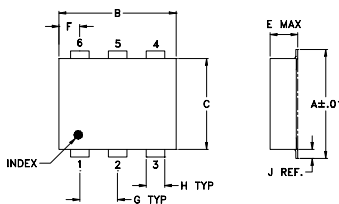

#### PCB Land Pattern

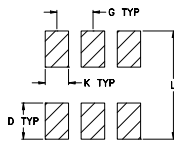

Suggested Layout, Tolerance to be within ±.002

### Outline Dimensions (inch/mm)

A	B	C	D	E	F	G
.272	.310	.220	.100	.112	.055	.100
6.91	7.87	5.59	2.54	2.84	1.40	2.54
H	J	K	L	wt		
.030	.026	.065	.300	grams		
0.76	0.66	1.65	7.62	0.20		

### Demo Board MCL P/N: TB-02 Suggested PCB Layout (PL-051)

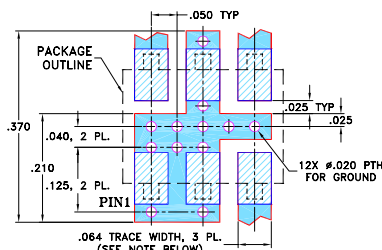

- NOTES: 1. TRACE WIDTH IS SHOWN FOR ROGERS RO4350B WITH DIELECTRIC THICKNESS .030" ± .002", COPPER: 1/2 OZ. EACH SIDE. FOR OTHER MATERIALS TRACE WIDTH MAY NEED TO BE MODIFIED.  
2. BOTTOM SIDE OF THE PCB IS CONTINUOUS GROUND PLANE.  
■ DENOTES PCB COPPER LAYOUT WITH SMOBC (SOLDER MASK OVER BARE COPPER)  
■ DENOTES COPPER LAND PATTERN FREE OF SOLDER MASK

### Notes

- A. Performance and quality attributes and conditions not expressly stated in this specification document are intended to be excluded and do not form a part of this specification document.  
B. Electrical specifications and performance data contained in this specification document are based on Mini-Circuit's applicable established test performance criteria and measurement instructions.  
C. The parts covered by this specification document are subject to Mini-Circuit's standard limited warranty and terms and conditions (collectively, "Standard Terms"); Purchasers of this part are entitled to the rights and benefits contained therein. For a full statement of the Standard Terms and the exclusive rights and remedies thereunder, please visit Mini-Circuit's website at [www.minicircuits.com/MCLStore/terms.jsp](http://www.minicircuits.com/MCLStore/terms.jsp)

### Electrical Specifications

FREQUENCY (MHz)		CONVERSION LOSS (dB)			LO-RF ISOLATION (dB)		LO-IF ISOLATION (dB)		IP3 at center band (dBm)
LO/RF	IF	$\bar{X}$	$\sigma$	Max.	Typ.	Min.	Typ.	Min.	Typ.
500-1200	DC-250	6.7	0.20	8.2	34	25	28	20	28

1 dB COMP.: +14 dBm typ.

### Typical Performance Data

Frequency (MHz)		Conversion Loss (dB)	Isolation L-R (dB)	Isolation L-I (dB)	VSWR RF Port (:1)	VSWR LO Port (:1)
RF	LO	LO +17dBm	LO +17dBm	LO +17dBm	LO +17dBm	LO +17dBm
500.00	530.00	6.78	39.10	33.60	6.05	3.50
539.38	569.38	6.29	38.60	33.70	4.64	3.26
581.85	611.85	6.47	37.90	35.00	5.49	3.21
600.00	630.00	6.60	37.70	35.20	4.12	3.21
627.67	657.67	6.14	36.60	34.00	3.64	2.96
650.00	680.00	6.10	36.20	33.80	4.64	2.92
677.10	707.10	6.29	36.60	35.40	4.22	3.01
700.00	730.00	6.16	36.20	34.60	3.21	3.01
730.43	760.43	6.12	35.30	32.90	3.44	3.01
750.00	780.00	6.43	35.00	33.60	3.86	2.92
787.95	817.95	6.21	34.70	32.60	3.06	2.92
800.00	830.00	6.32	34.60	31.90	2.96	2.84
850.00	880.00	6.41	35.20	31.30	3.64	2.96
900.00	930.00	6.33	34.60	28.90	2.92	2.88
950.00	980.00	6.24	34.70	30.20	3.32	2.61
1000.00	1030.00	6.00	34.90	29.20	2.92	2.43
1050.00	1080.00	6.15	35.60	30.00	3.16	2.49
1100.00	1130.00	6.44	35.60	29.20	2.88	2.55
1150.00	1180.00	6.50	34.90	27.90	3.16	2.61
1200.00	1230.00	6.78	34.10	28.30	2.96	2.76

### Electrical Schematic

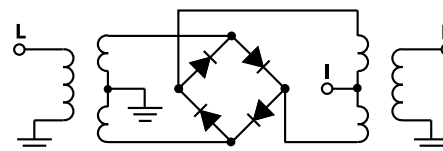

**Mini-Circuits®**

[www.minicircuits.com](http://www.minicircuits.com) P.O. Box 350166, Brooklyn, NY 11235-0003 (718) 934-4500 sales@minicircuits.com

REV. G  
M151107  
ADE-12H+  
ED-6460/2  
DJ/TD/CP/AM  
200415  
Page 1 of 2

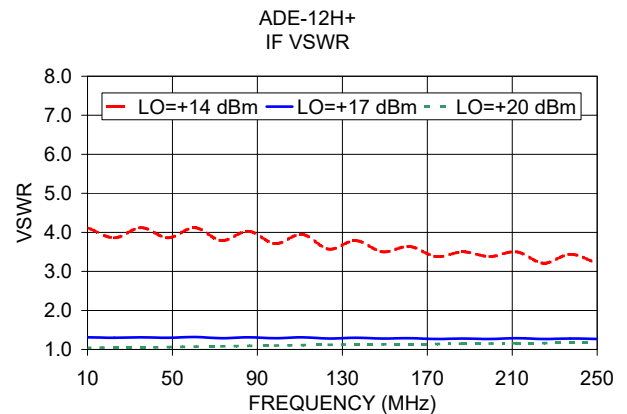
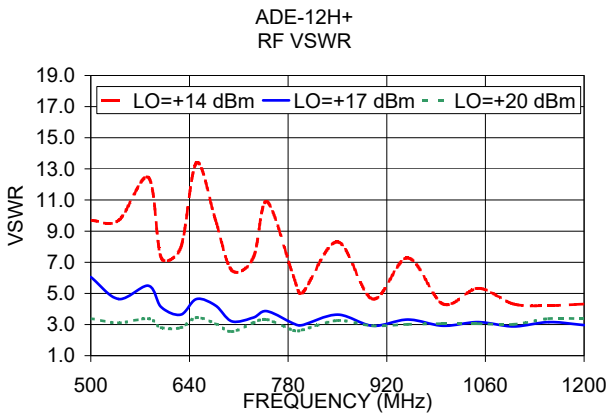
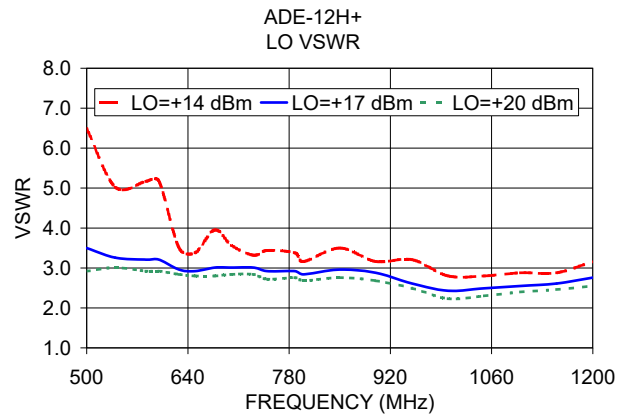
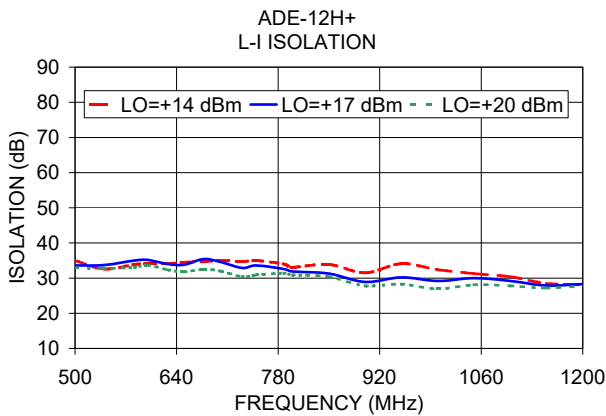
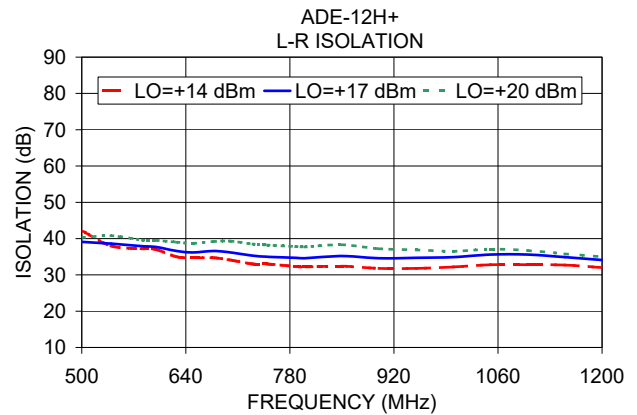
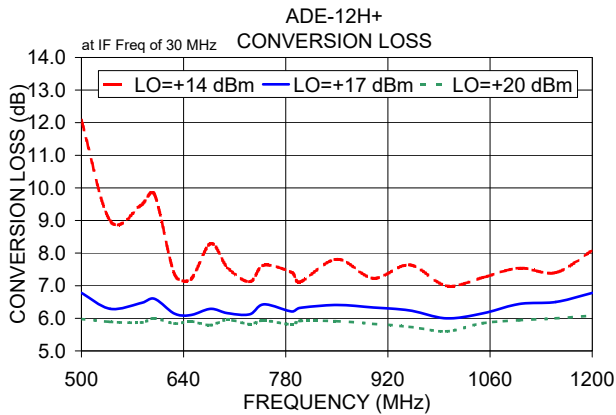

**Notes**

- A. Performance and quality attributes and conditions not expressly stated in this specification document are intended to be excluded and do not form a part of this specification document.
- B. Electrical specifications and performance data contained in this specification document are based on Mini-Circuit's applicable established test performance criteria and measurement instructions.
- C. The parts covered by this specification document are subject to Mini-Circuits standard limited warranty and terms and conditions (collectively, "Standard Terms"); Purchasers of this part are entitled to the rights and benefits contained therein. For a full statement of the Standard Terms and the exclusive rights and remedies thereunder, please visit Mini-Circuits' website at [www.minicircuits.com/MCLStore/terms.jsp](http://www.minicircuits.com/MCLStore/terms.jsp)



# Frequency Mixer

# ADE-12H+

## Typical Performance Data

RF (IN) (MHz)	LO (MHz)	CONVERSION LOSS IF FIXED @IF(OUT)=30MHz (dB)			RF (IN) (MHz)	LO (MHz)	IP3 INPUT (dBm)			RF (IN) (MHz)	LO (MHz)	COMPRESSION @RF IN=+14dBm (dB)		
		@LO (dBm)					@LO (dBm)					@LO (dBm)		
		+14	+17	+20			+14	+17	+20			+14	+17	+20
270.1	300.1	23.36	11.07	7.90	270.1	300.1	5.19	17.18	23.34	270.1	300.1	-11.48	-1.40	-0.07
310.1	340.1	19.23	9.71	7.20	310.1	340.1	7.13	18.05	21.25	310.1	340.1	-8.40	-1.02	0.13
350.1	380.1	16.67	8.62	6.69	350.1	380.1	8.50	16.07	22.52	350.1	380.1	-5.99	-0.57	0.14
390.1	420.1	13.02	7.50	6.47	390.1	420.1	11.40	20.78	29.13	390.1	420.1	-3.39	0.02	0.14
430.1	460.1	12.93	7.01	6.22	430.1	460.1	10.79	22.52	30.03	430.1	460.1	-3.31	0.37	0.24
470.1	500.1	10.24	6.57	6.13	470.1	500.1	13.29	18.67	27.98	470.1	500.1	-1.31	0.45	0.23
510.1	540.1	9.99	6.52	6.03	510.1	540.1	13.72	18.51	29.08	510.1	540.1	-1.20	0.44	0.26
550.1	580.1	8.70	6.38	6.01	550.1	580.1	17.03	21.27	28.98	550.1	580.1	-0.06	0.35	0.23
590.1	620.1	8.16	6.25	5.91	590.1	620.1	18.55	24.30	28.63	590.1	620.1	0.31	0.38	0.25
630.1	660.1	7.76	6.19	5.78	630.1	660.1	18.85	26.10	24.61	630.1	660.1	0.71	0.42	0.34
670.1	700.1	7.16	6.09	5.72	670.1	700.1	19.39	26.90	24.60	670.1	700.1	0.98	0.44	0.38
710.1	740.1	7.00	6.02	5.69	710.1	740.1	20.29	27.57	27.88	710.1	740.1	1.26	0.66	0.53
750.1	780.1	6.72	5.98	5.73	750.1	780.1	19.59	27.40	29.73	750.1	780.1	1.42	0.76	0.64
790.1	820.1	6.64	5.97	5.74	790.1	820.1	18.61	30.38	31.34	790.1	820.1	1.52	0.91	0.73
830.1	860.1	6.69	6.00	5.74	830.1	860.1	16.74	30.33	32.16	830.1	860.1	1.56	1.00	0.81
870.1	900.1	6.83	6.17	5.87	870.1	900.1	15.94	32.97	28.10	870.1	900.1	1.54	0.98	0.86
910.1	940.1	7.03	6.38	5.98	910.1	940.1	15.18	21.11	27.50	910.1	940.1	1.54	1.04	0.96
950.1	980.1	7.32	6.59	6.16	950.1	980.1	15.57	18.98	23.23	950.1	980.1	1.48	1.06	0.96
990.1	1020.1	7.46	6.68	6.19	990.1	1020.1	16.42	18.79	21.61	990.1	1020.1	1.57	1.14	1.03
1030.1	1060.1	7.68	6.87	6.32	1030.1	1060.1	17.03	18.71	20.78	1030.1	1060.1	1.72	1.22	1.14
1070.1	1100.1	7.70	6.83	6.30	1070.1	1100.1	18.03	19.30	21.11	1070.1	1100.1	1.85	1.35	1.27
1110.1	1140.1	7.62	6.74	6.22	1110.1	1140.1	19.10	20.65	23.40	1110.1	1140.1	1.98	1.46	1.42
1150.1	1180.1	7.47	6.46	5.86	1150.1	1180.1	22.51	22.68	22.70	1150.1	1180.1	2.20	1.74	1.64
1190.1	1220.1	7.15	5.97	5.45	1190.1	1220.1	23.16	21.81	21.67	1190.1	1220.1	2.52	2.21	1.97
1230.1	1260.1	7.43	5.94	5.41	1230.1	1260.1	21.22	19.78	19.77	1230.1	1260.1	2.37	2.37	2.04
1270.1	1300.1	7.49	5.88	5.26	1270.1	1300.1	18.36	18.47	18.52	1270.1	1300.1	2.33	2.54	2.25
1310.1	1340.1	7.43	5.98	5.31	1310.1	1340.1	17.51	17.96	18.12	1310.1	1340.1	2.34	2.49	2.28
1370.1	1400.1	7.26	6.08	5.40	1370.1	1400.1	16.75	17.21	17.61	1370.1	1400.1	2.51	2.61	2.47
1410.1	1440.1	7.12	6.02	5.44	1410.1	1440.1	16.56	16.91	17.40	1410.1	1440.1	2.56	2.69	2.57
1470.1	1500.1	7.35	6.37	5.72	1470.1	1500.1	15.96	16.55	17.35	1470.1	1500.1	2.27	2.56	2.67
1510.1	1540.1	7.70	6.76	6.13	1510.1	1540.1	15.96	16.66	17.80	1510.1	1540.1	1.87	2.17	2.37
1570.1	1600.1	8.11	7.65	7.19	1570.1	1600.1	15.76	16.02	17.19	1570.1	1600.1	1.36	1.33	1.49
1610.1	1640.1	7.89	7.70	7.48	1610.1	1640.1	16.40	15.89	16.41	1610.1	1640.1	1.47	1.22	1.17
1670.1	1700.1	7.81	7.60	7.51	1670.1	1700.1	19.91	18.41	17.86	1670.1	1700.1	1.62	1.29	1.14
1710.1	1740.1	8.06	7.77	7.68	1710.1	1740.1	23.28	21.18	20.30	1710.1	1740.1	1.32	1.05	0.89
1770.1	1800.1	8.66	8.33	8.14	1770.1	1800.1	22.97	23.44	23.55	1770.1	1800.1	0.87	0.65	0.53
1810.1	1840.1	8.96	8.64	8.49	1810.1	1840.1	23.05	23.46	23.52	1810.1	1840.1	0.66	0.41	0.34
1870.1	1900.1	9.56	9.26	9.11	1870.1	1900.1	22.74	25.41	23.62	1870.1	1900.1	0.44	0.20	0.12
1910.1	1940.1	9.96	9.67	9.50	1910.1	1940.1	21.94	27.48	26.24	1910.1	1940.1	0.22	0.09	0.06
1970.1	2000.1	10.54	10.20	9.98	1970.1	2000.1	20.07	22.49	27.07	1970.1	2000.1	0.07	0.07	0.04

# Frequency Mixer

# ADE-12H+

## Typical Performance Data

IF (OUT) (MHz)	LO (MHz)	CONVERSION LOSS VS. IF FREQUENCY @RF(IN)=850.1MHz (dB)	IF (OUT) (MHz)	LO (MHz)	CONVERSION LOSS VS. IF FREQUENCY @RF(IN)=500.1MHz (dB)	IF (OUT) (MHz)	LO (MHz)	CONVERSION LOSS VS. IF FREQUENCY @RF(IN)=1200.1MHz (dB)
		@LO (dBm)			@LO (dBm)			@LO (dBm)
		+17			+17			+17
250.0	600.1	5.48	10.0	510.1	6.52	250.0	950.1	6.63
237.4	612.7	5.49	16.2	516.3	6.48	243.8	956.3	6.62
224.7	625.4	5.51	22.3	522.4	6.46	237.7	962.4	6.63
212.1	638.0	5.50	28.5	528.6	6.47	231.5	968.6	6.68
199.5	650.6	5.55	34.6	534.7	6.45	225.4	974.7	6.67
186.8	663.3	5.56	40.8	540.9	6.52	219.2	980.9	6.67
174.2	675.9	5.56	46.9	547.0	6.56	213.1	987.0	6.69
161.6	688.5	5.62	53.1	553.2	6.60	206.9	993.2	6.71
148.9	701.2	5.62	59.2	559.3	6.58	200.8	999.3	6.78
136.3	713.8	5.63	65.4	565.5	6.53	194.6	1005.5	6.77
123.7	726.4	5.71	71.5	571.6	6.56	188.5	1011.6	6.76
111.1	739.0	5.76	77.7	577.8	6.53	182.3	1017.8	6.71
98.4	751.7	5.84	83.8	583.9	6.56	176.2	1023.9	6.69
85.8	764.3	5.87	90.0	590.1	6.56	170.0	1030.1	6.75
73.2	776.9	5.87	96.2	596.3	6.51	163.8	1036.3	6.75
60.5	789.6	5.95	102.3	602.4	6.54	157.7	1042.4	6.75
47.9	802.2	6.00	108.5	608.6	6.55	151.5	1048.6	6.69
35.3	814.8	6.05	114.6	614.7	6.60	145.4	1054.7	6.64
22.6	827.5	6.11	120.8	620.9	6.63	139.2	1060.9	6.67
10.0	840.1	6.10	126.9	627.0	6.62	133.1	1067.0	6.70
10.0	860.1	6.16	133.1	633.2	6.62	126.9	1073.2	6.69
22.6	872.7	6.06	139.2	639.3	6.61	120.8	1079.3	6.64
35.3	885.4	6.06	145.4	645.5	6.67	114.6	1085.5	6.56
47.9	898.0	6.08	151.5	651.6	6.70	108.5	1091.6	6.54
60.5	910.6	6.10	157.7	657.8	6.69	102.3	1097.8	6.55
73.2	923.3	6.19	163.8	663.9	6.68	96.2	1103.9	6.58
85.8	935.9	6.21	170.0	670.1	6.66	90.0	1110.1	6.56
98.4	948.5	6.17	176.2	676.3	6.70	83.8	1116.3	6.49
111.1	961.2	6.18	182.3	682.4	6.73	77.7	1122.4	6.46
123.7	973.8	6.18	188.5	688.6	6.73	71.5	1128.6	6.43
136.3	986.4	6.22	194.6	694.7	6.72	65.4	1134.7	6.44
148.9	999.0	6.31	200.8	700.9	6.69	59.2	1140.9	6.43
161.6	1011.7	6.31	206.9	707.0	6.69	53.1	1147.0	6.35
174.2	1024.3	6.36	213.1	713.2	6.73	46.9	1153.2	6.27
186.8	1036.9	6.48	219.2	719.3	6.76	40.8	1159.3	6.19
199.5	1049.6	6.51	225.4	725.5	6.79	34.6	1165.5	6.21
212.1	1062.2	6.65	231.5	731.6	6.74	28.5	1171.6	6.25
224.7	1074.8	6.75	237.7	737.8	6.75	22.3	1177.8	6.20
237.4	1087.5	6.81	243.8	743.9	6.73	16.2	1183.9	6.12
250.0	1100.1	7.04	250.0	750.1	6.75	10.0	1190.1	6.06

# Frequency Mixer

# ADE-12H+

## Typical Performance Data

LO (MHz)	LO-RF ISOLATION (dB)			LO-IF ISOLATION (dB)		
	@LO (dBm)			@LO (dBm)		
	+14	+17	+20	+14	+17	+20
270.1	40.17	40.42	40.99	43.79	39.47	34.95
310.1	41.89	41.80	42.51	41.51	35.94	34.34
350.1	44.52	43.32	43.23	40.12	35.24	34.29
390.1	47.97	44.44	43.83	38.20	34.61	34.46
430.1	48.25	42.56	43.40	36.98	34.66	34.78
470.1	46.21	41.76	43.89	36.39	34.95	34.74
510.1	41.38	41.14	43.97	35.40	34.98	34.83
550.1	39.09	39.65	42.85	35.23	35.32	35.30
590.1	36.77	38.29	41.17	35.23	35.89	35.61
630.1	35.27	36.95	40.04	35.24	35.93	35.29
670.1	34.15	36.71	40.18	35.12	35.67	34.75
710.1	33.43	36.57	40.39	34.52	34.82	34.50
750.1	32.90	36.58	40.39	33.66	33.90	34.27
790.1	33.25	37.60	41.27	32.87	32.80	33.42
830.1	32.96	37.56	40.80	32.92	31.98	32.26
870.1	33.48	37.46	40.01	32.80	31.92	31.78
910.1	34.02	37.71	39.80	32.88	32.74	32.16
950.1	34.09	37.65	39.65	33.00	33.96	33.08
990.1	33.86	37.40	39.27	32.76	34.17	33.59
1030.1	33.33	36.73	38.75	32.41	34.03	34.02
1070.1	32.74	35.90	38.04	32.15	33.56	33.95
1110.1	31.90	34.88	37.09	30.99	32.61	33.60
1150.1	31.25	34.31	36.76	30.53	32.65	34.36
1190.1	30.55	33.74	36.52	29.13	31.36	33.79
1230.1	29.49	32.86	35.91	27.30	28.99	31.30
1270.1	28.46	32.05	35.26	26.63	27.52	29.50
1310.1	27.60	31.18	34.81	26.38	26.78	28.38
1370.1	26.81	30.57	34.70	25.78	26.44	27.81
1410.1	26.31	29.81	33.73	25.33	26.32	27.69
1470.1	26.01	29.43	33.34	25.18	26.46	28.10
1510.1	25.91	29.04	32.52	24.90	26.29	28.03
1570.1	25.75	28.70	31.75	24.75	26.41	28.35
1610.1	25.53	28.44	31.33	24.83	26.69	28.80
1670.1	25.01	27.98	30.81	24.52	26.78	29.38
1710.1	24.65	27.58	30.41	24.17	26.55	29.36
1770.1	24.24	27.06	29.69	24.17	26.84	29.88
1810.1	24.00	26.75	29.32	24.10	26.81	29.84
1870.1	23.99	26.73	29.13	24.32	27.11	30.06
1910.1	24.13	26.81	29.07	24.74	27.45	30.11
1970.1	24.67	27.24	29.18	25.72	28.15	29.95

RF (IN) (MHz)	LO (MHz)	RF-IF ISOLATION (dB)		
		@LO (dBm)		
		+14	+17	+20
270.1	300.1	22.53	24.69	25.62
310.1	340.1	21.40	23.93	25.15
350.1	380.1	20.43	23.12	24.32
390.1	420.1	20.43	22.79	23.81
430.1	460.1	19.55	22.52	23.98
470.1	500.1	20.07	23.27	25.20
510.1	540.1	19.14	22.90	25.03
550.1	580.1	18.86	22.34	22.93
590.1	620.1	18.89	21.50	21.95
630.1	660.1	19.12	21.51	22.51
670.1	700.1	20.34	22.74	24.60
710.1	740.1	21.01	24.98	27.97
750.1	780.1	22.78	27.76	29.73
790.1	820.1	23.43	25.64	24.95
830.1	860.1	22.36	21.41	20.41
870.1	900.1	20.46	19.00	17.88
910.1	940.1	18.67	17.47	16.42
950.1	980.1	16.80	15.82	15.07
990.1	1020.1	15.76	14.96	14.34
1030.1	1060.1	15.17	14.57	14.11
1070.1	1100.1	14.84	14.45	14.11
1110.1	1140.1	14.55	14.29	14.04
1150.1	1180.1	14.30	14.04	13.85
1190.1	1220.1	13.86	13.54	13.39
1230.1	1260.1	13.64	13.21	13.14
1270.1	1300.1	13.75	13.23	13.19
1310.1	1340.1	13.83	13.36	13.20
1370.1	1400.1	13.96	13.70	13.35
1410.1	1440.1	14.03	13.96	13.62
1470.1	1500.1	13.97	14.13	13.94
1510.1	1540.1	13.88	14.06	13.95
1570.1	1600.1	13.38	13.31	13.08
1610.1	1640.1	12.73	12.37	11.79
1670.1	1700.1	11.56	11.04	10.24
1710.1	1740.1	10.79	10.21	9.38
1770.1	1800.1	9.69	9.17	8.41
1810.1	1840.1	8.89	8.33	7.67
1870.1	1900.1	7.67	7.08	6.50
1910.1	1940.1	6.83	6.18	5.55
1970.1	2000.1	5.69	4.99	4.42

# Frequency Mixer

# ADE-12H+

## Typical Performance Data

RF (IN) (MHz)	LO (MHz)	RF VSWR (:1)		
		@LO (dBm)		
		+14	+17	+20
270.1	300.1	22.00	8.99	5.85
310.1	340.1	16.26	7.25	4.79
350.1	380.1	12.52	6.09	4.14
390.1	420.1	9.04	4.66	3.73
430.1	460.1	8.51	4.12	3.40
470.1	500.1	6.19	3.50	3.18
510.1	540.1	5.70	3.38	3.08
550.1	580.1	4.51	3.16	2.97
590.1	620.1	3.95	2.97	2.81
630.1	660.1	3.56	2.83	2.64
670.1	700.1	3.06	2.66	2.51
710.1	740.1	2.92	2.49	2.40
750.1	780.1	2.66	2.38	2.32
790.1	820.1	2.55	2.32	2.27
830.1	860.1	2.48	2.30	2.25
870.1	900.1	2.47	2.34	2.27
910.1	940.1	2.52	2.39	2.28
950.1	980.1	2.50	2.36	2.25
990.1	1020.1	2.46	2.32	2.20
1030.1	1060.1	2.44	2.28	2.16
1070.1	1100.1	2.37	2.21	2.10
1110.1	1140.1	2.29	2.12	2.00
1150.1	1180.1	2.15	1.94	1.81
1190.1	1220.1	1.98	1.74	1.62
1230.1	1260.1	1.93	1.62	1.49
1270.1	1300.1	1.86	1.54	1.38
1310.1	1340.1	1.78	1.48	1.30
1370.1	1400.1	1.66	1.42	1.25
1410.1	1440.1	1.63	1.42	1.27
1470.1	1500.1	1.72	1.55	1.41
1510.1	1540.1	1.81	1.68	1.55
1570.1	1600.1	1.95	1.98	1.94
1610.1	1640.1	1.90	2.00	2.06
1670.1	1700.1	1.92	1.98	2.06
1710.1	1740.1	2.03	2.04	2.08
1770.1	1800.1	2.21	2.18	2.17
1810.1	1840.1	2.28	2.24	2.20
1870.1	1900.1	2.35	2.28	2.24
1910.1	1940.1	2.34	2.25	2.20
1970.1	2000.1	2.28	2.17	2.10

LO (MHz)	LO VSWR (:1)		
	@LO (dBm)		
	+14	+17	+20
270.1	34.75	27.59	10.89
310.1	32.79	15.67	7.38
350.1	30.49	14.15	6.24
390.1	25.56	10.37	5.16
430.1	22.58	8.72	4.34
470.1	19.76	7.76	4.03
510.1	15.39	5.70	3.67
550.1	15.96	5.28	3.47
590.1	12.09	4.40	3.34
630.1	11.31	4.01	3.26
670.1	9.18	3.61	3.14
710.1	7.47	3.35	3.09
750.1	6.83	3.21	3.06
790.1	5.46	3.05	3.11
830.1	5.04	2.94	3.12
870.1	4.29	2.76	3.06
910.1	3.90	2.65	3.04
950.1	3.54	2.57	3.02
990.1	3.23	2.54	3.06
1030.1	3.00	2.52	3.11
1070.1	2.79	2.52	3.15
1110.1	2.67	2.54	3.22
1150.1	2.51	2.56	3.30
1190.1	2.37	2.52	3.29
1230.1	2.21	2.47	3.29
1270.1	2.10	2.43	3.30
1310.1	2.07	2.42	3.30
1370.1	2.03	2.49	3.43
1410.1	1.99	2.49	3.42
1470.1	1.94	2.57	3.55
1510.1	1.92	2.57	3.56
1570.1	1.94	2.68	3.70
1610.1	1.96	2.71	3.73
1670.1	2.02	2.84	3.90
1710.1	2.06	2.89	3.95
1770.1	2.14	3.02	4.11
1810.1	2.19	3.09	4.19
1870.1	2.26	3.18	4.30
1910.1	2.31	3.24	4.36
1970.1	2.34	3.25	4.35

IF (OUT) (MHz)	IF VSWR @LO=1200.1MHz (:1)		
	@LO (dBm)		
	+14	+17	+20
10.1	2.35	1.69	1.45
16.1	2.40	1.76	1.50
22.1	2.58	1.88	1.60
28.1	2.38	1.72	1.48
34.1	2.49	1.81	1.54
40.1	2.31	1.69	1.43
46.1	2.24	1.65	1.42
52.1	2.33	1.71	1.46
58.1	2.25	1.65	1.40
64.1	2.21	1.64	1.40
70.1	2.27	1.68	1.43
76.1	2.26	1.66	1.43
82.1	2.35	1.73	1.48
88.1	2.34	1.73	1.48
94.1	2.36	1.75	1.50
100.1	2.34	1.73	1.48
106.1	2.39	1.78	1.53
112.1	2.36	1.76	1.51
118.1	2.39	1.77	1.52
124.1	2.36	1.75	1.49
130.1	2.40	1.79	1.53
136.1	2.41	1.80	1.54
142.1	2.39	1.78	1.53
148.1	2.36	1.76	1.52
154.1	2.40	1.81	1.55
160.1	2.38	1.79	1.54
166.1	2.44	1.84	1.58
172.1	2.41	1.82	1.57
178.1	2.40	1.81	1.56
184.1	2.44	1.84	1.59
190.1	2.41	1.82	1.57
196.1	2.45	1.84	1.59
202.1	2.43	1.83	1.58
208.1	2.45	1.85	1.60
214.1	2.43	1.85	1.60
220.1	2.47	1.88	1.63
226.1	2.41	1.85	1.60
232.1	2.45	1.88	1.63
244.1	2.41	1.86	1.61
250.1	2.41	1.85	1.60

## Harmonics Tables

RF HARMONICS ORDER

	(-dBm)	(-dBc)										
0	-	-	7	13	15	27	17	31	28	50	42	48
1	-	14	+0	16	11	30	38	27	45	45	54	61
2	89	49	57	60	53	57	63	79	51	59	64	68
3	>100	61	59	54	69	50	57	62	71	64	71	79
4	>100	>93	>93	84	88	83	83	80	92	>93	90	89
5	>100	>93	>93	92	>93	84	92	84	86	91	>93	>93
6	>100	>93	>93	>93	>93	>93	>93	>93	91	>93	>93	>93
7	>100	>93	>93	>93	>93	>93	>93	>93	>93	>93	>93	>93
8	>100	>93	>93	>93	>93	>93	>93	>93	>93	>93	>93	>93
9	>100	>93	>93	>93	>93	>93	>93	>93	>93	>93	>93	>93
10	>100	>93	>93	>93	>93	>93	>93	>93	>93	>93	>93	>93
	RF CAL	0	1	2	3	4	5	6	7	8	9	10

### LO HARMONICS ORDER

Test conditions: RF IN: 850.1 MHz; -1.00 dBm.  
 LO IN: 880.01 MHz; +17.00 dBm  
 IF OUT: 29.91 MHz; -7.34 dBm

RF HARMONICS ORDER

	(-dBm)	(-dBc)										
0	-	-	17	23	27	39	31	42	42	62	57	61
1	-	14	+0	19	12	31	41	31	53	51	72	68
2	75	44	55	49	55	56	46	61	44	55	58	69
3	>100	42	46	46	55	34	38	52	62	44	63	66
4	>100	69	66	57	56	64	64	66	74	68	65	64
5	>100	58	65	60	62	49	59	51	59	57	61	59
6	>100	79	89	80	84	72	69	71	69	69	80	75
7	>100	86	80	96	79	81	70	71	66	67	63	75
8	>100	>103	>103	96	87	95	86	79	82	78	77	78
9	>100	>103	>103	>103	92	87	91	81	79	80	77	74
10	>100	>103	>103	>103	>103	96	>103	99	88	87	83	85
	RF CAL	0	1	2	3	4	5	6	7	8	9	10

### LO HARMONICS ORDER

Test conditions: RF IN: 850.1 MHz; 9.00 dBm.  
 LO IN: 880.01 MHz; +17.00 dBm  
 IF OUT: 29.91 MHz; 2.59 dBm

- Notes: 1. All Harmonics are in (dBc) relative to IF OUTPUT.  
 2. + entry denotes harmonics are in (dBc) above IF OUTPUT.  
 3. RF Cal represent the Harmonics level of the RF input signal to the mixer.

REV. X2  
 ADE-12H+  
 100817  
 Page 5 of 5



IF/RF MICROWAVE COMPONENTS • ISO 9001 ISO 14001 AS 9100 CERTIFIED • RoHS compliant  
 P.O. Box 350166, Brooklyn, New York 11235-0006 (718) 934-4500 Fax (718) 332-4661



The Design Engineers Search Engine finds the model you need, Instantly • For detailed performance specs & shopping online see





## Typical Performance Curves

Conversion Loss @ IF=30MHz

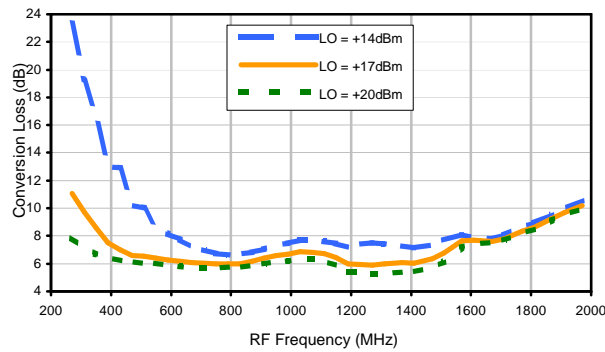

Conversion Loss vs. LO @ RF=850.1MHz

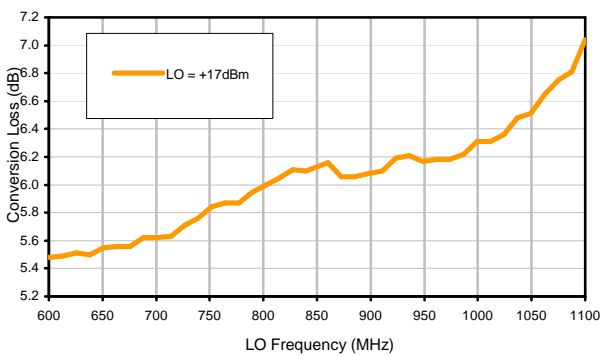

Conversion Loss vs. IF @ RF=850.1MHz

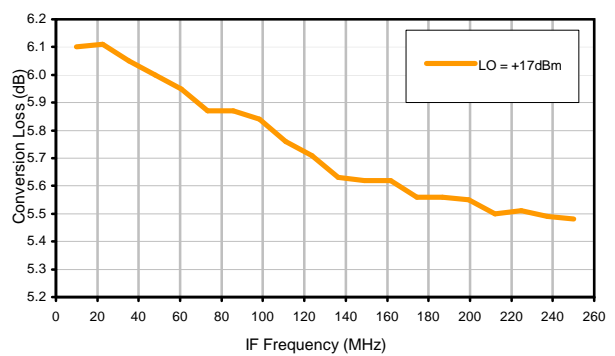

Conversion Loss vs. IF @ RF=500.1MHz

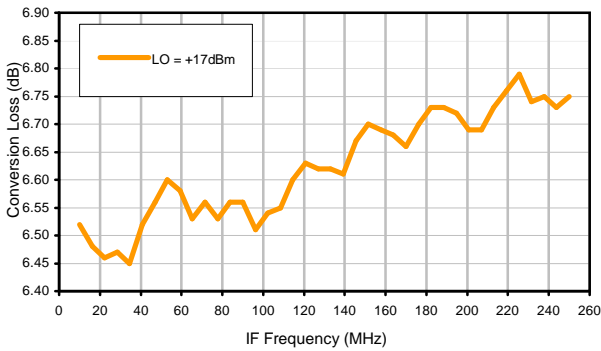

Conversion Loss vs. IF @ RF=1200.1MHz

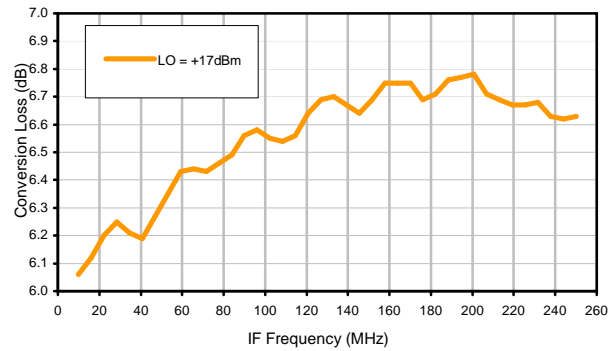

IP3 Input

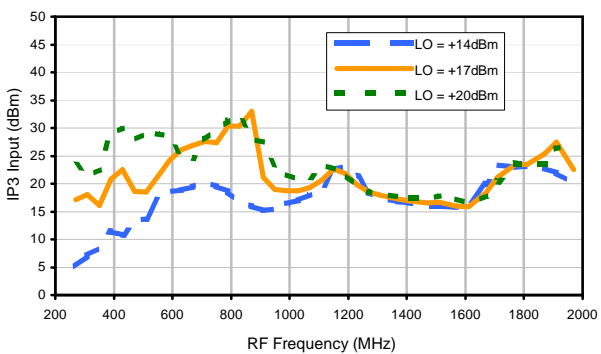

Compression @ RF IN=+14dBm

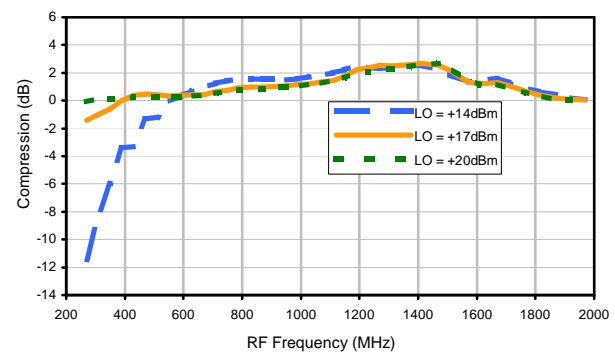



## Typical Performance Curves

LO-RF Isolation

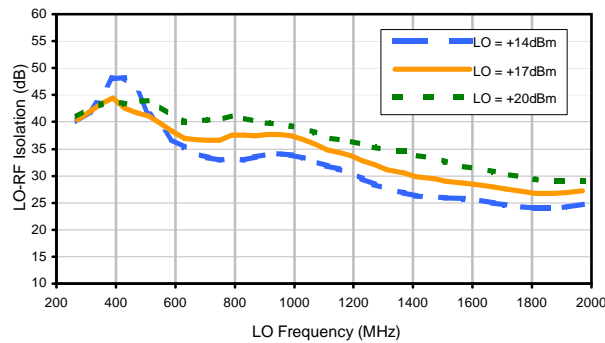

LO-IF Isolation

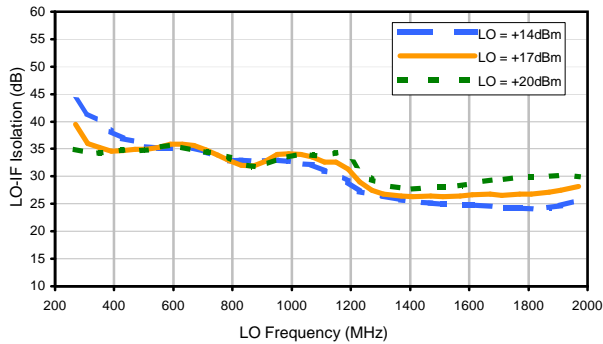

RF-IF Isolation

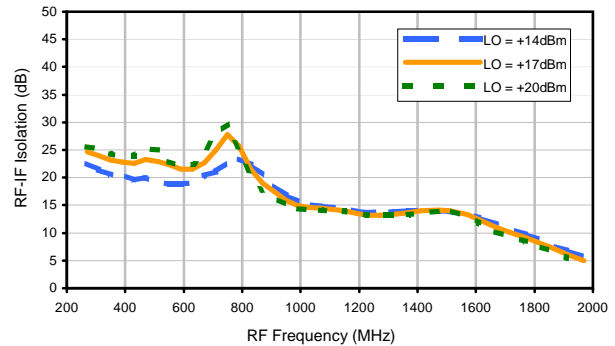

RF VSWR

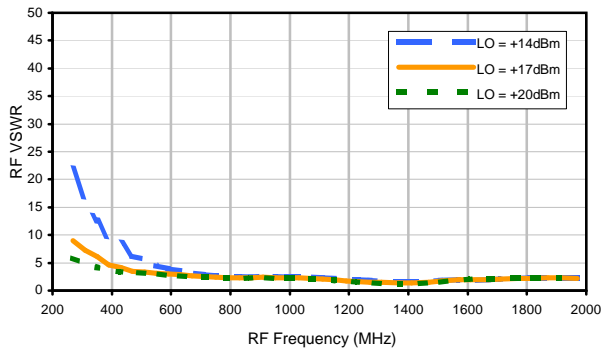

LO VSWR

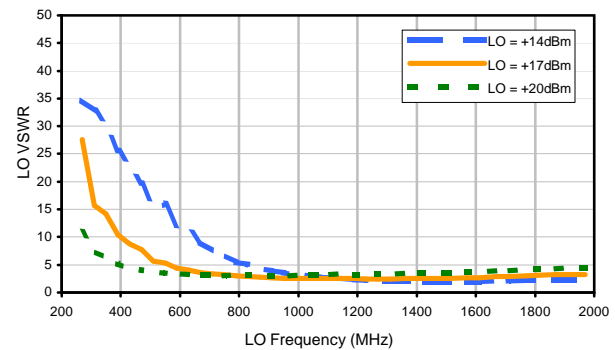

IF VSWR

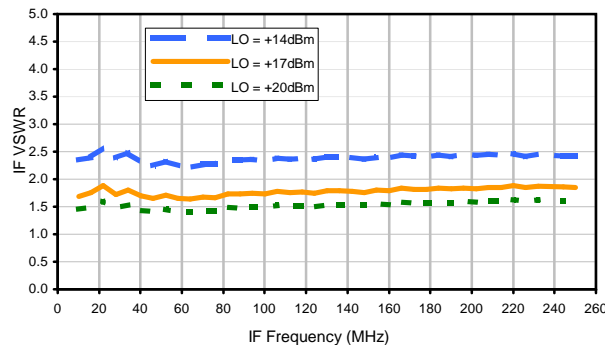

## Harmonics Tables

RF HARMONICS ORDER

	(-dBm)	(-dBc)										
0	-	-	7	13	15	27	17	31	28	50	42	48
1	-	14	+0	16	11	30	38	27	45	45	54	61
2	89	49	57	60	53	57	63	79	51	59	64	68
3	>100	61	59	54	69	50	57	62	71	64	71	79
4	>100	>93	>93	84	88	83	83	80	92	>93	90	89
5	>100	>93	>93	92	>93	84	92	84	86	91	>93	>93
6	>100	>93	>93	>93	>93	>93	>93	>93	91	>93	>93	>93
7	>100	>93	>93	>93	>93	>93	>93	>93	>93	>93	>93	>93
8	>100	>93	>93	>93	>93	>93	>93	>93	>93	>93	>93	>93
9	>100	>93	>93	>93	>93	>93	>93	>93	>93	>93	>93	>93
10	>100	>93	>93	>93	>93	>93	>93	>93	>93	>93	>93	>93
	RF CAL	0	1	2	3	4	5	6	7	8	9	10

### LO HARMONICS ORDER

Test conditions: RF IN: 850.1 MHz; -1.00 dBm.  
 LO IN: 880.01 MHz; +17.00 dBm  
 IF OUT: 29.91 MHz; -7.34 dBm

RF HARMONICS ORDER

	(-dBm)	(-dBc)										
0	-	-	17	23	27	39	31	42	42	62	57	61
1	-	14	+0	19	12	31	41	31	53	51	72	68
2	75	44	55	49	55	56	46	61	44	55	58	69
3	>100	42	46	46	55	34	38	52	62	44	63	66
4	>100	69	66	57	56	64	64	66	74	68	65	64
5	>100	58	65	60	62	49	59	51	59	57	61	59
6	>100	79	89	80	84	72	69	71	69	69	80	75
7	>100	86	80	96	79	81	70	71	66	67	63	75
8	>100	>103	>103	96	87	95	86	79	82	78	77	78
9	>100	>103	>103	>103	92	87	91	81	79	80	77	74
10	>100	>103	>103	>103	>103	96	>103	99	88	87	83	85
	RF CAL	0	1	2	3	4	5	6	7	8	9	10

### LO HARMONICS ORDER

Test conditions: RF IN: 850.1 MHz; 9.00 dBm.  
 LO IN: 880.01 MHz; +17.00 dBm  
 IF OUT: 29.91 MHz; 2.59 dBm

- Notes: 1. All Harmonics are in (dBc) relative to IF OUTPUT.  
 2. + entry denotes harmonics are in (dBc) above IF OUTPUT.  
 3. RF Cal represent the Harmonics level of the RF input signal to the mixer.

REV. X2  
 ADE-12H+  
 100817  
 Page 3 of 3



IF/RF MICROWAVE COMPONENTS • ISO 9001 ISO 14001 AS 9100 CERTIFIED • RoHS compliant  
 P.O. Box 350166, Brooklyn, New York 11235-0006 (718) 934-4500 Fax (718) 332-4661



The Design Engineers Search Engine finds the model you need, Instantly • For detailed performance specs & shopping online see



# Case Style

# CD

CD541  
CD542  
CD636  
CD637

## Outline Dimensions



## PCB Land Pattern



Suggested Layout,  
Tolerance to be within  $\pm.002$

CASE#	A	B	C	D	E	F	G	H	J	K	L	WT, GRAM
CD541					.082 (2.08)							.15
CD542	.272 (6.91)	.310 (7.87)	.220 (5.58)	.100 (2.54)	.112 (2.84)	.055 (1.40)	.100 (2.54)	.030 (0.76)	.026 (0.66)	.065 (1.65)	.300 (7.62)	.20
CD636					.162 (4.11)							.25
CD637					.206 (5.23)							.40

Dimensions are in inches (mm). Tolerances: 2 Pl.  $\pm .01$ ; 3 Pl.  $\pm .005$

### Notes:

- Case material: Plastic.
- Termination finish:
  - For RoHS Case Styles: Tin plate over Nickel plate. All models, (+) suffix.
  - For RoHS-5 Case Styles: Tin-Lead plate. All models, no (+) suffix.

**Mini-Circuits**

INTERNET <http://www.minicircuits.com>

P.O. Box 350166, Brooklyn, New York 11235-0003 (718) 934-4500 Fax (718) 332-4661

Distribution Centers NORTH AMERICA 800-654-7949 • 417-335-5935 • Fax 417-335-5945 • EUROPE 44-1252-832600 • Fax 44-1252-837010

Mini-Circuits ISO 9001 & ISO 14001 Certified

# Tape & Reel Packaging TR-F34



Tape Width, mm	Device Cavity Pitch, mm	Reel Size, inches	Devices per Reel see note	
16	12	7	Small quantity standard (see note)	20
				50
				100
				200
		13	Standard	500
1000				

Note: Availability of small reel quantity varies by model.  
Refer to pricing and availability on individual model dashboard.

Mini-Circuits carrier tape materials provide protection from ESD (Electro-Static Discharge) during handling and transportation. Tapes are static dissipative and comply with industry standards EIA-481/EIA-541.

Go to: [www.minicircuits.com/pages/pdfs/tape.pdf](http://www.minicircuits.com/pages/pdfs/tape.pdf)



INTERNET <http://www.minicircuits.com>

P.O. Box 350166, Brooklyn, New York 11235-0003 (718) 934-4500 Fax (718) 332-4661

Distribution Centers NORTH AMERICA 800-654-7949 • 417-335-5935 • Fax 417-335-5945 • EUROPE 44-1252-832600 • Fax 44-1252-837010

Mini-Circuits ISO 9001 & ISO 14001 Certified

THIRD ANGLE PROJECTION

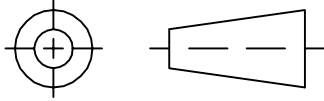



REVISIONS

REV	ECN No.	DESCRIPTION	DATE	DR	AUTH
OR	M82272	NEW RELEASE	08/05/02	MMG	DJ
A	M102713	ADDED NOTE 2 & "...WITH SMOBC"	01/17/06	MMG	IL

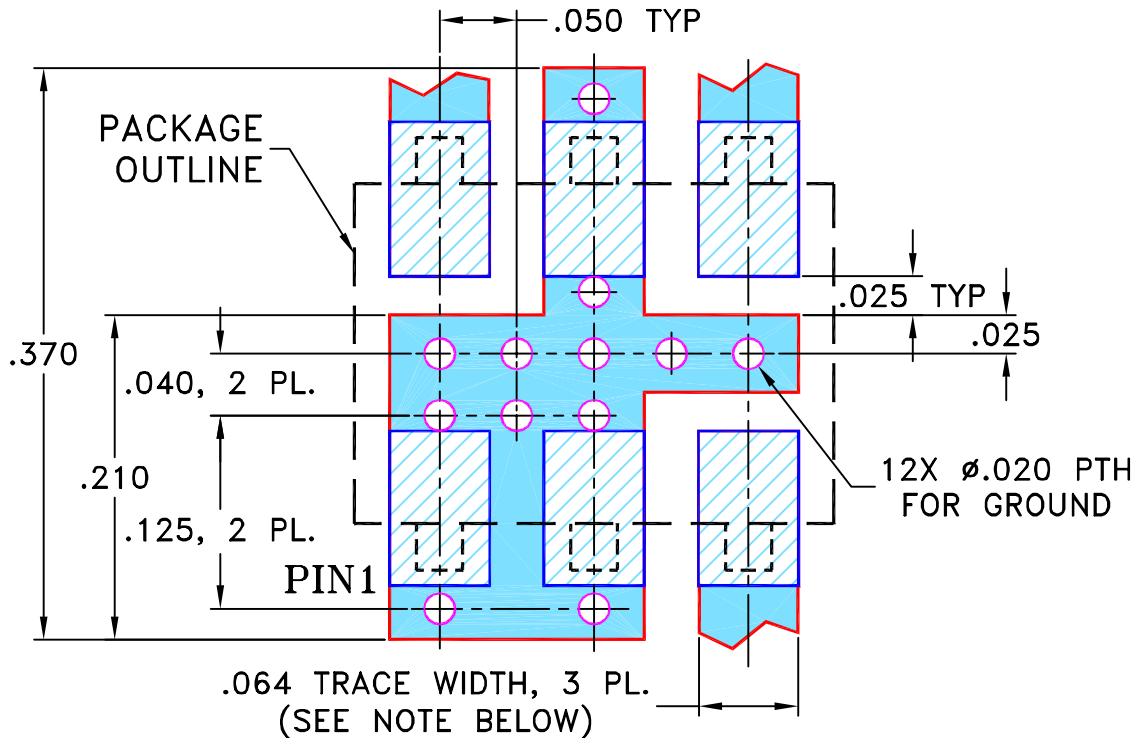
SUGGESTED MOUNTING CONFIGURATION  
FOR CD541/542/636/637 CASE STYLES,  
"jv", "ju", "jw" PIN CONNECTIONS



- NOTES:** 1. TRACE WIDTH IS SHOWN FOR ROGERS R04350B WITH DIELECTRIC THICKNESS .030" ± .002"; COPPER: 1/2 OZ. EACH SIDE. FOR OTHER MATERIALS TRACE WIDTH MAY NEED TO BE MODIFIED.  
 2. BOTTOM SIDE OF THE PCB IS CONTINUOUS GROUND PLANE.

-  DENOTES PCB COPPER LAYOUT WITH SMOBC (SOLDER MASK OVER BARE COPPER)  
 DENOTES COPPER LAND PATTERN FREE OF SOLDER MASK

UNLESS OTHERWISE SPECIFIED

DIMENSIONS ARE IN INCHES  
 TOLERANCES ON:  
 2 PL DECIMALS ±  
 3 PL DECIMALS ± .005  
 ANGLES ±  
 FRACTIONS ±

	INITIALS	DATE
DRAWN	MMG	07/17/02
CHECKED	WL	08/02/02
APPROVED	DJ	08/05/02



**Mini-Circuits®**

13 Neptune Avenue  
 Brooklyn NY 11235

PL, jv/ju/jw, CD541/542/636/637, ADE, TB-02

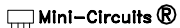
 Mini-Circuits®  
 THIS DOCUMENT AND ITS CONTENTS ARE THE PROPERTY OF MINI-CIRCUITS. EXCEPT FOR USE EXPRESSLY GRANTED, IN WRITING, TO ITS VENDORS, VENDEE AND THE UNITED STATES GOVERNMENT, MINI-CIRCUITS RESERVES ALL PROPRIETARY DESIGN, USE, MANUFACTURING AND REPRODUCTION RIGHTS THERETO. THESE CONTENTS SHALL NOT BE USED, DUPLICATED OR DISCLOSED TO ANY OUTSIDE PARTY, IN WHOLE OR IN PART, WITHOUT WRITTEN PERMISSION OF MINI-CIRCUITS.

SIZE A	CODE IDENT 15542	DRAWING NO: 98-PL-051	REV: A
FILE: 98PL051	SCALE: 8:1	SHEET: 1 OF 1	

# Evaluation Board and Circuit

For Pin Connections refer to Data Sheet of the DUT

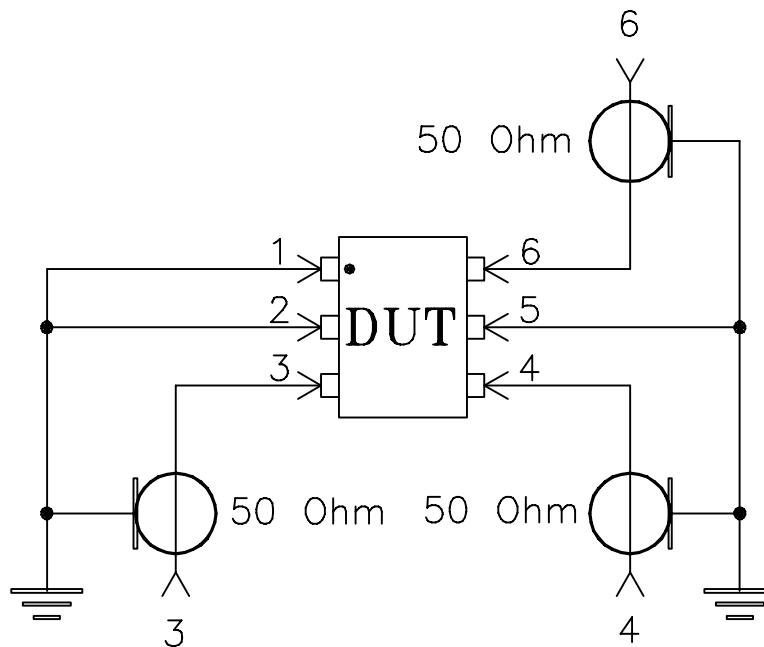
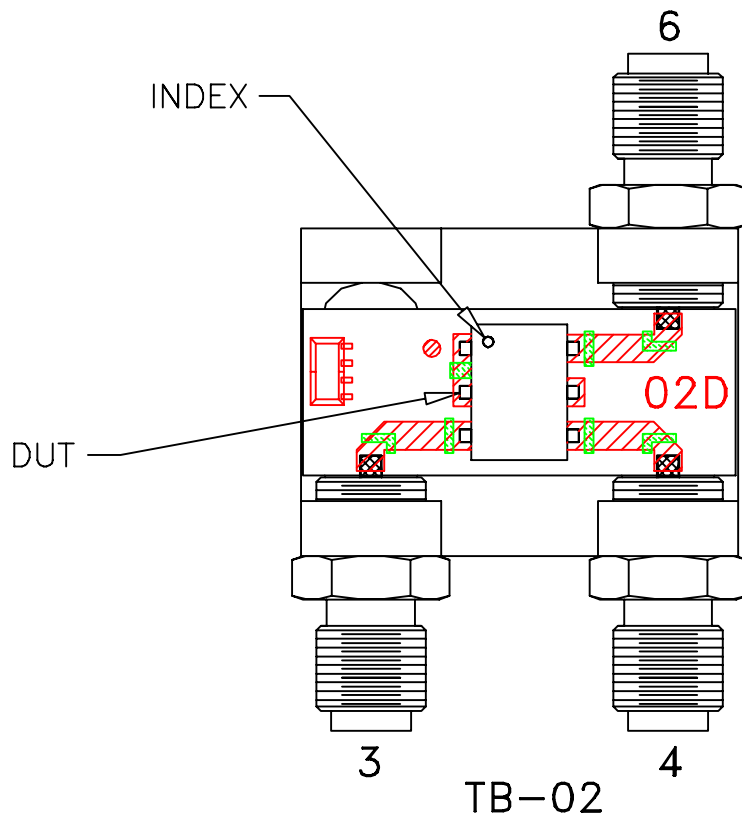

Schematic Diagram

## Notes:

1. SMA Female connectors.
2. PCB Material: Rogers R04350 or equivalent,  
Dielectric Constant=3.5, Thickness=.030 inch.

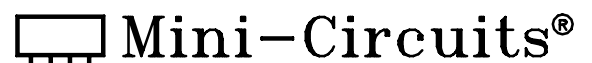



All Mini-Circuits products are manufactured under exacting quality assurance and control standards, and are capable of meeting published specifications after being subjected to any or all of the following physical and environmental test.

Specification	Test/Inspection Condition	Reference/Spec
Operating Temperature	-40° to 85°C Ambient Environment	Individual Model Data Sheet
Storage Temperature	-55° to 100° C Ambient Environment	Individual Model Data Sheet
Humidity	90 to 95% RH, 240 hours, 50°C	MIL-STD-202, Method 103, Condition A, Except 50°C and end-point electrical test done within 12 hours
Thermal Shock	-55° to 100°C, 100 cycles	MIL-STD-202, Method 107, Condition A-3, except +100°C
Solder Reflow Heat	Sn-Pb Eutetic Process: 225°C peak Pb-Free Process 245° - 250°C peak	J-STD-020, Table 4-1, 4-2 and 5-2, Figure 5-1
Solderability	10X Magnification	J-STD-002, 95% Coverage
Vibration (High Frequency)	20g peak, 10-2000 Hz, 12 times in each of three perpendicular directions (total 36)	MIL-STD-202, Method 204, Condition D
Mechanical Shock	50g, 11 ms, 1/2-sine, 18 shocks: 3 each direction, each of 3 axes	MIL-STD-202, Method 213, Condition A
Marking Resistance to Solvents	Isopropyl alcohol + mineral spirits at 25°C; terpene defluxer at 25°C; distilled water + proylene glycol monomethyl ether + monoethanolamine at 63°C to 70°C	MIL-STD-202, Method 215