

### The Big Deal:

- Ultra Flat Gain Response:  
± 0.4 dB over 900-2150 MHz
- Excellent Combination of gain, P1dB, IP3 and NF
- 50Ω Input and Output:  
no External Components Required

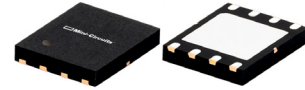

CASE STYLE: DL1636

### Product Overview:

YSF-2151+ is an advanced amplifier module in a Mini-Circuits System In Package **MSiP<sup>®</sup>**. This module is fully matched to 50Ω in/out impedance and has built-in Input & Output DC block capacitors. It is enclosed in a 5 x 6 mm MCLP plastic package. The YSF-2151+ uses E-PHEMT technology enabling it to work with a single positive supply voltage.

### Key Features

Feature	Advantages
Superior gain flatness ± 0.4dB	The YSF-2151+ provides industry leading gain flatness over the full satellite communications L Band (900-2150 MHz) making this ideal for use in applications where gain-flatness and repeatability are critical performance requirements.
High Gain	The YSF-2151+ is a two-stage design with internal feedback and bias to provide flat 20 dB nominal gain, supporting applications where a single gain block must overcome large system losses such as long cable runs and lossy components.
Strong Combination of Performance	The YSF-2151+ provides a strong combination of performance parameters including high gain (20 dB), high IP3 (+35 dBm) and P1dB (+20 dBm) and low noise figures (2.8 dB) that are difficult to achieve in a single stage design and available only in the YSF amplifier series.
Integrated Matching, DC Blocking and Bias in Small Package	The YSF-2151+ includes all support circuits including: Matching, Bias and DC Blocking, all integrated into a single 5x6mm package making the total footprint equal to or smaller than most solutions
Excellent Return Loss	The YSF-2151+ includes integrated input and output matching and bias circuits to make this amplifier a simple, complete drop-in solution. The matching circuits provide excellent output return loss (20dB), and are designed to give optimal P1dB and IP3 performance in a 50Ω environment.
High Reverse Isolation	With 30 dB of reverse isolation – the YSF-2151+ is an ideal gain block for use in integrated systems to minimize VSWR interactions resulting from cascading highly reflective components, such as sharp filters.

#### Notes

- A. Performance and quality attributes and conditions not expressly stated in this specification document are intended to be excluded and do not form a part of this specification document.  
 B. Electrical specifications and performance data contained in this specification document are based on Mini-Circuit's applicable established test performance criteria and measurement instructions.  
 C. The parts covered by this specification document are subject to Mini-Circuits standard limited warranty and terms and conditions (collectively, "Standard Terms"); Purchasers of this part are entitled to the rights and benefits contained therein. For a full statement of the Standard Terms and the exclusive rights and remedies thereunder, please visit Mini-Circuits' website at [www.minicircuits.com/MCLStore/terms.jsp](http://www.minicircuits.com/MCLStore/terms.jsp)

# Flat Gain Amplifier

0.9-2.15 GHz

## Product Features

- Matched 50-ohm surface mount amplifier
- High gain, 20 dB typ. at 2 GHz
- Up to +20 dBm typ. output power at 2 GHz
- High IP3, +35 dBm at 2 GHz
- Low Noise Figure, 2.8 dB typ. at 2 GHz
- High directivity, 30 dB isolation
- Internal Input & Output DC Block
- Separate terminal for DC
- Protected by us patent 8,994,157



Generic photo used for illustration purposes only

## YSF-2151+

CASE STYLE: DL1636

## Typical Applications

- Cellular
- Portable Wireless
- Satellite Communications
- Receivers & transmitters

### +RoHS Compliant

The +Suffix identifies RoHS Compliance. See our web site for RoHS Compliance methodologies and qualifications

## General Description

YSF-2151+ is an advanced amplifier module in a Mini-Circuits System In Package **MSiP<sup>®</sup>**. This module is fully matched to 50Ω in/out impedance and has built-in Input & Output DC block capacitors. It is enclosed in a 5 x 6 mm MCLP plastic package. The YSF-2151+ uses E-PHEMT\* technology enabling it to work with a single positive supply voltage.

### simplified schematic and pad description

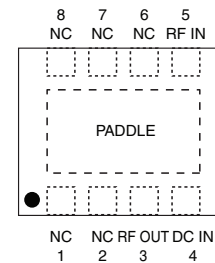
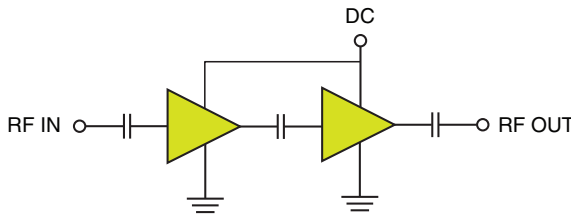

Function	Pad Number	Description
RF-IN	5	RF Input
RF-OUT	3	RF Output
DC	4	DC Supply
GND	Paddle	Connected to ground
NOT USED	1,2,6,7,8	No internal connection

\*Enhancement mode Pseudomorphic High Electron Mobility Transistor

### Notes

- A. Performance and quality attributes and conditions not expressly stated in this specification document are intended to be excluded and do not form a part of this specification document.  
 B. Electrical specifications and performance data contained in this specification document are based on Mini-Circuit's applicable established test performance criteria and measurement instructions.  
 C. The parts covered by this specification document are subject to Mini-Circuits standard limited warranty and terms and conditions (collectively, "Standard Terms"); Purchasers of this part are entitled to the rights and benefits contained therein. For a full statement of the Standard Terms and the exclusive rights and remedies thereunder, please visit Mini-Circuits' website at [www.minicircuits.com/MCLStore/terms.jsp](http://www.minicircuits.com/MCLStore/terms.jsp)



**Electrical Specifications<sup>(1)</sup> at 25°C, Zo=50Ω unless noted**

Parameter	Condition (MHz)	Min.	Typ.	Max.	Units
Frequency Range		900		2150	MHz
Gain	900	18.2	20.2	22.2	dB
	1600	18.0	20.0	22.0	
	2150	18.0	19.8	22.0	
Gain Flatness			0.4		± dB
Input Return Loss	900	—	10.0		dB
	1600	8.0	10.0		
	2150	—	11.5		
Output Return Loss	900	—	14.0		dB
	1600	16.0	22.0		
	2150	—	23.0		
Reverse Isolation			30.5		dB
Output Power @1 dB compression	900	—	20.0		dBm
	1600	—	20.0		
	2150	18.0	20.0		
Output Power @3 dB compression			21.0		dBm
Output IP3	900	—	36.0		dBm
	1600	30.0	35.0		
	2150	—	35.0		
Noise Figure	900		3.5	—	dB
	1600		3.1	4.1	
	2150		2.6	—	
Device Operating Voltage			5		V
Device Operating Current			118	145	mA
Device Current Variation vs. Temperature <sup>(2)</sup>			2		μA/°C
Device Current Variation vs Voltage			0.002		mA/mV
Thermal Resistance, junction-to-ground lead <sup>(3)</sup>			56		°C/W

<sup>(1)</sup> Measured on Mini-Circuits Characterization test board TB-616+. See Characterization Test Circuit (Fig. 1)

<sup>(2)</sup> D(+85°C to -45°C)

<sup>(3)</sup> Thermal Resistance=  $\frac{\text{Hot spot temperature} - \text{Ground lead temperature}}{\text{Power Dissipation}}$

**Absolute Maximum Ratings**

Parameter	Ratings	Units
Operating Temperature <sup>(4)</sup>	-40 to 85	°C
Storage Temperature	-65 to 150	°C
DC Voltage on Pad 4	7	V
Power Dissipation	1.5	W
Input Power	21	dBm

Note: Permanent damage may occur if any of these limits are exceeded. These ratings are not intended for continuous normal operation.

<sup>(4)</sup> Case is defined as ground paddle.

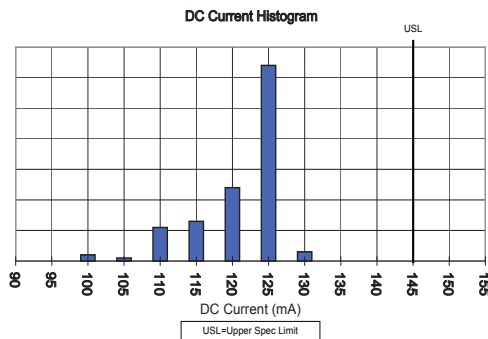

**Notes**

- A. Performance and quality attributes and conditions not expressly stated in this specification document are intended to be excluded and do not form a part of this specification document.
- B. Electrical specifications and performance data contained in this specification document are based on Mini-Circuit's applicable established test performance criteria and measurement instructions.
- C. The parts covered by this specification document are subject to Mini-Circuits standard limited warranty and terms and conditions (collectively, "Standard Terms"); Purchasers of this part are entitled to the rights and benefits contained therein. For a full statement of the Standard Terms and the exclusive rights and remedies thereunder, please visit Mini-Circuits' website at [www.minicircuits.com/MCLStore/terms.jsp](http://www.minicircuits.com/MCLStore/terms.jsp)



### Characterization Test Circuit

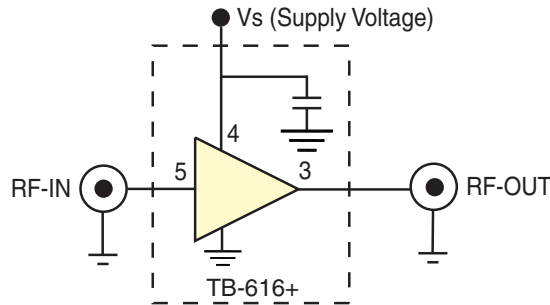

**Fig 1.** Block Diagram of Test Circuit used for characterization. (DUT soldered on Mini-Circuits Characterization Test Fixture TB-616+) Gain, Return loss, Output power at 1dB compression (P1 dB), Output IP3 (OIP3) and Noise Figure measured using Agilent's N5242A PNA-X microwave network analyzer.

**Conditions:**

1. Gain: Pin= -25dBm
2. Output IP3 (OIP3): Two tones, spaced 1 MHz apart, 0 dBm/tone at output.

### Recommended Application Circuit

(refer to evaluation board for PCB Layout and component values)

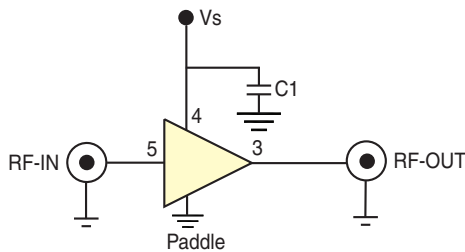

**Fig 2.** Recommended Application Circuit

### Product Marking

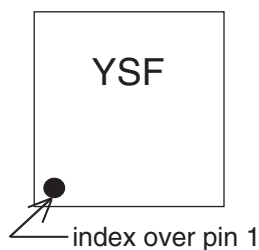

**Notes**

- A. Performance and quality attributes and conditions not expressly stated in this specification document are intended to be excluded and do not form a part of this specification document.
- B. Electrical specifications and performance data contained in this specification document are based on Mini-Circuit's applicable established test performance criteria and measurement instructions.
- C. The parts covered by this specification document are subject to Mini-Circuits standard limited warranty and terms and conditions (collectively, "Standard Terms"); Purchasers of this part are entitled to the rights and benefits contained therein. For a full statement of the Standard Terms and the exclusive rights and remedies thereunder, please visit Mini-Circuits' website at [www.minicircuits.com/MCLStore/terms.jsp](http://www.minicircuits.com/MCLStore/terms.jsp)

<b>Additional Detailed Technical Information</b>	
<i>additional information is available on our dash board. To access this information <a href="#">click here</a></i>	
<b>Performance Data</b>	Data Table
	Swept Graphs
	S-Parameter (S2P Files) Data Set (.zip file)
<b>Case Style</b>	DL1636 <i>Plastic package, exposed paddle, lead finish: tin/silver/nickel</i>
<b>Tape &amp; Reel</b> Standard quantities available on reel	F68 <i>7" reels with 20, 50, 100, 200, 500 or 1K devices. 13" reels with 2K, 3K, 4K devices.</i>
<b>Suggested Layout for PCB Design</b>	PL-352
<b>Evaluation Board</b>	TB-616-7+
<b>Environmental Ratings</b>	ENV08T1

### ESD Rating

Human Body Model (HBM): Class 1A in accordance with ANSI/ESD STM 5.1 - 2001

Machine Model (MM): Class M1 (25V) in accordance with ANSI/ESD STM5.2-1999



**Attention**  
 Observe precautions  
 for handling electrostatic  
 sensitive devices

### MSL Rating

Moisture Sensitivity: MSL1 in accordance with IPC/JEDEC J-STD-020D

### MSL Test Flow Chart

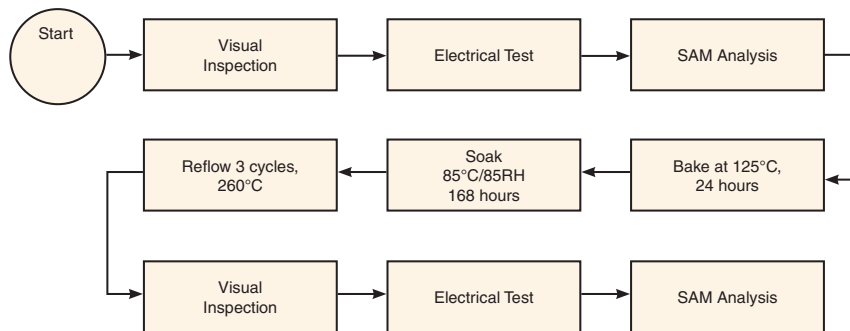

**Notes**

- A. Performance and quality attributes and conditions not expressly stated in this specification document are intended to be excluded and do not form a part of this specification document.
- B. Electrical specifications and performance data contained in this specification document are based on Mini-Circuit's applicable established test performance criteria and measurement instructions.
- C. The parts covered by this specification document are subject to Mini-Circuits standard limited warranty and terms and conditions (collectively, "Standard Terms"); Purchasers of this part are entitled to the rights and benefits contained therein. For a full statement of the Standard Terms and the exclusive rights and remedies thereunder, please visit Mini-Circuits' website at [www.minicircuits.com/MCLStore/terms.jsp](http://www.minicircuits.com/MCLStore/terms.jsp)



## Typical Performance Data

**NOTE: Use PDF Bookmarks to view DATA at required conditions**

**Definitions:**

Input Return Loss = -S11 (dB)

Gain(Power Gain) = S21 (dB)

Reverse Isolation = -S12 (dB)

Output Return Loss = -S22 (dB)

TEST CONDITIONS: Vd = 5.00V, Id=122.35mA @ Temperature = +25degC

FREQ	Gain	Isolation	Input Return Loss	Output Return Loss	Stability		IP-3 Output	1dB Comp. Output	Noise Figure
					K	Measure			
(MHz)	(dB)	(dB)	(dB)	(dB)			(dBm)	(dBm)	(dB)
900.0	20.65	32.53	11.13	15.25	1.87	0.99	37.57	20.86	3.44
950.0	20.69	32.33	11.79	15.95	1.86	0.98	37.25	20.89	3.36
960.0	20.69	32.32	11.92	16.08	1.86	0.98	37.72	20.92	3.35
970.0	20.69	32.21	12.01	16.23	1.84	0.98	37.76	20.79	3.35
980.0	20.69	32.14	12.11	16.36	1.83	0.97	37.93	20.70	3.37
990.0	20.69	32.18	12.19	16.49	1.84	0.97	36.93	20.81	3.44
1000.0	20.69	32.13	12.25	16.66	1.83	0.97	37.35	20.92	3.41
1050.0	20.66	31.75	12.60	17.39	1.78	0.97	37.10	20.90	3.39
1100.0	20.62	31.71	12.70	18.03	1.79	0.97	37.18	20.87	3.36
1150.0	20.55	31.53	12.69	18.54	1.77	0.97	36.97	20.90	3.32
1200.0	20.49	31.46	12.59	19.02	1.77	0.97	36.81	20.81	3.31
1250.0	20.43	31.33	12.42	19.45	1.76	0.98	36.94	20.77	3.27
1300.0	20.36	31.12	12.28	19.96	1.73	0.98	37.02	20.81	3.27
1350.0	20.30	31.14	12.10	20.44	1.74	0.98	36.87	20.79	3.21
1400.0	20.25	31.02	11.94	20.78	1.73	0.98	36.47	20.80	3.19
1450.0	20.21	30.96	11.80	21.01	1.72	0.99	36.37	20.73	3.14
1500.0	20.17	30.89	11.68	21.24	1.71	0.99	36.16	20.64	3.12
1550.0	20.14	30.69	11.59	21.47	1.68	0.99	36.34	20.71	3.06
1600.0	20.12	30.82	11.52	21.70	1.71	0.99	36.09	20.68	3.02
1650.0	20.11	30.75	11.45	22.12	1.70	0.99	36.12	20.71	2.97
1700.0	20.12	30.66	11.46	22.34	1.68	0.99	36.12	20.79	2.92
1750.0	20.12	30.63	11.43	22.47	1.68	0.99	35.84	20.76	2.89
1800.0	20.14	30.52	11.44	22.48	1.66	0.99	36.05	20.76	2.81
1850.0	20.15	30.64	11.55	22.48	1.68	0.99	35.76	20.81	2.80
1900.0	20.17	30.44	11.60	22.67	1.65	0.98	35.73	20.80	2.80
1950.0	20.20	30.53	11.70	22.80	1.66	0.98	35.83	20.81	2.90
2000.0	20.22	30.55	11.84	22.87	1.66	0.98	35.73	20.85	2.72
2050.0	20.24	30.42	12.00	22.77	1.65	0.97	35.87	20.81	2.69
2100.0	20.25	30.45	12.25	22.66	1.65	0.97	35.59	20.81	2.65
2150.0	20.25	30.48	12.46	22.40	1.66	0.96	35.58	20.84	2.60

## Typical Performance Data

### Definitions:

Input Return Loss = -S11 (dB)

Gain(Power Gain) = S21 (dB)

Reverse Isolation = -S12 (dB)

Output Return Loss = -S22 (dB)

TEST CONDITIONS: Vd = 4.75V, Id=121.67mA @ Temperature = +25degC

FREQ	Gain	Isolation	Input Return Loss	Output Return Loss	Stability		IP-3 Output	1dB Comp. Output	Noise Figure
					K	Measure			
(MHz)	(dB)	(dB)	(dB)	(dB)	K	Measure	(dBm)	(dBm)	(dB)
900.0	20.69	32.53	11.17	15.31	1.87	0.98	37.23	20.59	3.37
950.0	20.73	32.34	11.84	16.03	1.85	0.98	37.16	20.61	3.37
960.0	20.73	32.19	11.98	16.16	1.83	0.97	36.85	20.65	3.35
970.0	20.73	32.12	12.07	16.33	1.82	0.97	37.11	20.50	3.34
980.0	20.72	32.16	12.18	16.48	1.83	0.97	37.42	20.40	3.34
990.0	20.73	32.15	12.25	16.61	1.83	0.97	36.87	20.52	3.38
1000.0	20.72	32.01	12.33	16.79	1.81	0.97	36.93	20.64	3.34
1050.0	20.69	31.90	12.65	17.52	1.81	0.97	36.73	20.62	3.38
1100.0	20.65	31.62	12.76	18.19	1.77	0.97	36.98	20.59	3.33
1150.0	20.58	31.54	12.75	18.72	1.77	0.97	36.74	20.62	3.34
1200.0	20.52	31.44	12.63	19.24	1.76	0.97	36.58	20.52	3.30
1250.0	20.45	31.21	12.47	19.70	1.73	0.97	36.60	20.48	3.24
1300.0	20.39	31.19	12.31	20.27	1.74	0.98	36.68	20.52	3.25
1350.0	20.33	31.05	12.15	20.78	1.72	0.98	36.33	20.49	3.20
1400.0	20.28	31.01	11.98	21.10	1.72	0.98	36.17	20.50	3.18
1450.0	20.24	30.85	11.85	21.38	1.70	0.98	36.07	20.44	3.16
1500.0	20.19	30.86	11.73	21.65	1.71	0.99	36.02	20.35	3.08
1550.0	20.17	30.75	11.65	21.82	1.69	0.99	35.81	20.43	3.04
1600.0	20.15	30.71	11.56	22.07	1.69	0.99	35.69	20.40	3.02
1650.0	20.14	30.66	11.51	22.45	1.68	0.99	35.94	20.42	2.95
1700.0	20.15	30.58	11.48	22.69	1.67	0.99	35.86	20.52	2.91
1750.0	20.15	30.47	11.46	22.81	1.65	0.98	35.82	20.48	2.90
1800.0	20.17	30.45	11.48	22.73	1.64	0.98	35.59	20.48	2.83
1850.0	20.18	30.50	11.60	22.63	1.65	0.98	35.50	20.53	2.82
1900.0	20.20	30.43	11.64	22.76	1.64	0.98	35.67	20.53	2.82
1950.0	20.23	30.36	11.75	22.77	1.63	0.97	35.49	20.53	2.83
2000.0	20.25	30.40	11.88	22.75	1.64	0.97	35.49	20.58	2.74
2050.0	20.28	30.38	12.03	22.53	1.63	0.97	35.58	20.54	2.68
2100.0	20.29	30.50	12.27	22.23	1.66	0.97	35.12	20.53	2.68
2150.0	20.30	30.33	12.49	21.96	1.64	0.96	35.14	20.57	2.61

## Typical Performance Data

### Definitions:

Input Return Loss = -S11 (dB)

Gain(Power Gain) = S21 (dB)

Reverse Isolation = -S12 (dB)

Output Return Loss = -S22 (dB)

TEST CONDITIONS: Vd = 5.25V, Id=122.70mA @ Temperature = +25degC

FREQ	Gain	Isolation	Input Return Loss	Output Return Loss	Stability		IP-3 Output	1dB Comp. Output	Noise Figure
					K	Measure			
(MHz)	(dB)	(dB)	(dB)	(dB)	K	Measure	(dBm)	(dBm)	(dB)
900.0	20.63	32.63	11.09	15.19	1.89	0.99	37.61	21.13	3.43
950.0	20.67	32.28	11.74	15.89	1.85	0.98	37.55	21.16	3.34
960.0	20.67	32.30	11.87	16.00	1.85	0.98	37.59	21.19	3.37
970.0	20.67	32.19	11.97	16.14	1.84	0.98	37.75	21.06	3.36
980.0	20.67	32.21	12.06	16.27	1.84	0.98	37.85	20.98	3.39
990.0	20.67	32.08	12.14	16.41	1.82	0.97	37.29	21.08	3.34
1000.0	20.67	32.21	12.20	16.58	1.85	0.98	37.51	21.19	3.40
1050.0	20.64	31.95	12.54	17.24	1.82	0.97	36.93	21.16	3.36
1100.0	20.59	31.82	12.66	17.87	1.81	0.97	36.97	21.14	3.33
1150.0	20.54	31.53	12.64	18.37	1.77	0.97	37.16	21.16	3.31
1200.0	20.47	31.53	12.54	18.83	1.78	0.98	37.25	21.08	3.33
1250.0	20.41	31.36	12.37	19.23	1.76	0.98	36.86	21.05	3.28
1300.0	20.34	31.25	12.22	19.70	1.75	0.98	37.08	21.09	3.28
1350.0	20.28	31.23	12.06	20.13	1.76	0.98	36.76	21.06	3.22
1400.0	20.24	31.09	11.90	20.48	1.74	0.99	36.89	21.08	3.19
1450.0	20.19	31.05	11.77	20.67	1.73	0.99	36.77	21.01	3.14
1500.0	20.15	30.93	11.64	20.95	1.72	0.99	36.62	20.92	3.13
1550.0	20.12	30.84	11.54	21.15	1.71	0.99	36.34	20.97	3.05
1600.0	20.10	30.82	11.47	21.38	1.70	0.99	36.46	20.96	3.04
1650.0	20.10	30.74	11.41	21.74	1.69	0.99	36.53	20.99	2.97
1700.0	20.10	30.73	11.41	22.00	1.69	0.99	36.16	21.05	2.94
1750.0	20.10	30.61	11.40	22.21	1.67	0.99	36.22	21.03	2.93
1800.0	20.12	30.61	11.41	22.29	1.67	0.99	36.06	21.03	2.82
1850.0	20.13	30.67	11.52	22.32	1.68	0.99	36.16	21.07	2.82
1900.0	20.15	30.57	11.54	22.57	1.67	0.98	36.05	21.07	2.78
1950.0	20.17	30.70	11.67	22.75	1.69	0.98	35.92	21.08	2.90
2000.0	20.20	30.48	11.80	22.86	1.65	0.98	35.98	21.12	2.74
2050.0	20.21	30.48	11.99	22.87	1.66	0.97	35.74	21.08	2.67
2100.0	20.22	30.56	12.21	22.87	1.67	0.97	35.74	21.07	2.68
2150.0	20.22	30.59	12.44	22.82	1.69	0.97	35.49	21.10	2.58



## Typical Performance Data

### Definitions:

Input Return Loss = -S11 (dB)

Gain(Power Gain) = S21 (dB)

Reverse Isolation = -S12 (dB)

Output Return Loss = -S22 (dB)

TEST CONDITIONS: Vd = 5.00V, Id=120.34mA @ Temperature = -45degC

FREQ	Gain	Isolation	Input Return Loss	Output Return Loss	Stability		IP-3 Output	1dB Comp. Output	Noise Figure
					K	Measure			
(MHz)	(dB)	(dB)	(dB)	(dB)	K	Measure	(dBm)	(dBm)	(dB)
900.0	21.11	32.74	11.16	14.97	1.82	0.98	37.97	20.96	2.84
950.0	21.16	32.42	11.91	15.69	1.79	0.97	38.15	21.00	2.75
960.0	21.16	32.44	12.04	15.82	1.79	0.97	38.53	21.03	2.78
970.0	21.17	32.40	12.17	15.97	1.79	0.97	38.34	20.90	2.74
980.0	21.17	32.42	12.27	16.09	1.80	0.97	39.04	20.81	2.78
990.0	21.17	32.29	12.35	16.23	1.78	0.97	38.26	20.91	2.84
1000.0	21.17	32.31	12.44	16.37	1.78	0.97	38.35	21.03	2.80
1050.0	21.15	32.14	12.86	16.97	1.77	0.96	38.24	21.01	2.77
1100.0	21.11	31.82	13.06	17.57	1.73	0.96	38.34	20.98	2.78
1150.0	21.06	31.68	13.11	18.07	1.72	0.96	38.23	21.00	2.79
1200.0	21.01	31.55	13.05	18.65	1.70	0.96	38.44	20.91	2.74
1250.0	20.95	31.47	12.88	19.08	1.70	0.96	38.68	20.87	2.72
1300.0	20.90	31.41	12.77	19.53	1.70	0.97	38.57	20.90	2.71
1350.0	20.84	31.15	12.59	19.83	1.66	0.97	38.50	20.88	2.64
1400.0	20.79	31.08	12.41	20.09	1.65	0.97	38.29	20.90	2.63
1450.0	20.77	31.11	12.34	20.40	1.66	0.97	38.12	20.85	2.61
1500.0	20.73	30.96	12.19	20.63	1.64	0.97	38.20	20.73	2.57
1550.0	20.71	30.94	12.10	20.86	1.64	0.97	38.08	20.79	2.49
1600.0	20.70	30.80	11.99	21.12	1.62	0.97	37.78	20.77	2.47
1650.0	20.69	30.76	11.91	21.44	1.62	0.97	38.04	20.80	2.41
1700.0	20.70	30.73	11.88	21.60	1.61	0.97	37.79	20.88	2.36
1750.0	20.72	30.64	11.84	21.81	1.59	0.97	37.72	20.87	2.41
1800.0	20.73	30.69	11.91	21.88	1.60	0.97	37.75	20.87	2.27
1850.0	20.76	30.56	12.01	21.91	1.58	0.96	37.78	20.93	2.28
1900.0	20.79	30.50	12.05	22.08	1.57	0.96	37.26	20.91	2.26
1950.0	20.83	30.52	12.12	22.19	1.57	0.96	37.47	20.92	2.27
2000.0	20.86	30.46	12.20	22.25	1.56	0.96	37.17	20.98	2.22
2050.0	20.89	30.50	12.42	22.35	1.57	0.95	36.99	20.95	2.13
2100.0	20.91	30.56	12.58	22.26	1.58	0.95	36.56	20.95	2.15
2150.0	20.95	30.52	12.80	21.90	1.57	0.94	36.99	20.98	2.08

## Typical Performance Data

### Definitions:

Input Return Loss = -S11 (dB)

Gain(Power Gain) = S21 (dB)

Reverse Isolation = -S12 (dB)

Output Return Loss = -S22 (dB)

TEST CONDITIONS: Vd = 4.75V, Id=120.40mA @ Temperature = -45degC

FREQ	Gain	Isolation	Input Return Loss	Output Return Loss	Stability		IP-3 Output	1dB Comp. Output	Noise Figure
					K	Measure			
(MHz)	(dB)	(dB)	(dB)	(dB)			(dBm)	(dBm)	(dB)
900.0	21.09	32.84	11.16	15.01	1.85	0.98	38.52	20.68	2.84
950.0	21.14	32.53	11.90	15.77	1.81	0.97	38.47	20.72	2.80
960.0	21.14	32.43	12.04	15.86	1.79	0.97	39.16	20.75	2.79
970.0	21.15	32.34	12.16	16.02	1.78	0.97	38.75	20.61	2.76
980.0	21.15	32.25	12.25	16.16	1.77	0.97	39.19	20.51	2.79
990.0	21.15	32.30	12.37	16.29	1.78	0.97	38.34	20.62	2.80
1000.0	21.15	32.28	12.44	16.42	1.78	0.97	38.46	20.74	2.81
1050.0	21.13	32.08	12.83	17.04	1.76	0.96	38.32	20.73	2.78
1100.0	21.09	31.83	13.04	17.65	1.73	0.96	38.34	20.70	2.79
1150.0	21.03	31.68	13.10	18.20	1.72	0.96	38.17	20.72	2.77
1200.0	20.99	31.49	13.04	18.76	1.70	0.96	38.56	20.62	2.77
1250.0	20.92	31.42	12.86	19.22	1.69	0.96	38.77	20.58	2.70
1300.0	20.87	31.35	12.74	19.65	1.69	0.97	39.30	20.61	2.69
1350.0	20.81	31.17	12.56	19.97	1.67	0.97	38.57	20.59	2.64
1400.0	20.77	31.04	12.38	20.27	1.65	0.97	38.09	20.61	2.61
1450.0	20.74	31.16	12.31	20.57	1.68	0.97	38.38	20.56	2.63
1500.0	20.70	30.98	12.17	20.77	1.65	0.97	38.53	20.45	2.57
1550.0	20.68	30.89	12.09	21.07	1.64	0.97	38.51	20.52	2.51
1600.0	20.67	30.85	11.98	21.31	1.63	0.97	38.03	20.49	2.48
1650.0	20.66	30.77	11.87	21.61	1.62	0.97	38.24	20.52	2.43
1700.0	20.67	30.75	11.84	21.77	1.62	0.97	37.91	20.62	2.38
1750.0	20.69	30.57	11.82	22.01	1.59	0.97	37.76	20.59	2.38
1800.0	20.71	30.57	11.88	22.06	1.59	0.97	37.45	20.59	2.28
1850.0	20.73	30.49	11.97	22.04	1.57	0.96	37.51	20.65	2.27
1900.0	20.76	30.48	12.02	22.20	1.57	0.96	37.76	20.64	2.26
1950.0	20.80	30.47	12.08	22.30	1.57	0.96	37.36	20.65	2.26
2000.0	20.84	30.46	12.16	22.39	1.56	0.96	37.11	20.72	2.18
2050.0	20.86	30.62	12.39	22.40	1.59	0.96	37.07	20.68	2.13
2100.0	20.89	30.37	12.51	22.32	1.55	0.95	36.78	20.67	2.14
2150.0	20.93	30.29	12.74	21.87	1.54	0.94	36.58	20.71	2.08

## Typical Performance Data

### Definitions:

Input Return Loss = -S11 (dB)

Gain(Power Gain) = S21 (dB)

Reverse Isolation = -S12 (dB)

Output Return Loss = -S22 (dB)

TEST CONDITIONS: Vd = 5.25V, Id=120.94mA @ Temperature = -45degC

FREQ	Gain	Isolation	Input Return Loss	Output Return Loss	Stability		IP-3 Output	1dB Comp. Output	Noise Figure
					K	Measure			
(MHz)	(dB)	(dB)	(dB)	(dB)	K	Measure	(dBm)	(dBm)	(dB)
900.0	21.13	32.77	11.17	14.93	1.83	0.98	38.19	21.22	2.85
950.0	21.17	32.44	11.91	15.66	1.79	0.97	37.98	21.26	2.74
960.0	21.18	32.42	12.05	15.77	1.78	0.97	37.38	21.29	2.78
970.0	21.18	32.42	12.17	15.90	1.79	0.97	38.52	21.17	2.77
980.0	21.18	32.43	12.26	16.04	1.79	0.97	38.50	21.09	2.78
990.0	21.19	32.30	12.37	16.18	1.77	0.96	38.36	21.19	2.80
1000.0	21.19	32.33	12.46	16.31	1.78	0.97	38.60	21.29	2.82
1050.0	21.16	32.12	12.86	16.94	1.76	0.96	38.14	21.27	2.79
1100.0	21.13	31.98	13.06	17.50	1.75	0.96	38.24	21.24	2.77
1150.0	21.07	31.68	13.13	18.00	1.71	0.96	38.36	21.26	2.76
1200.0	21.03	31.55	13.05	18.55	1.70	0.96	38.51	21.17	2.77
1250.0	20.97	31.53	12.88	18.98	1.70	0.96	38.23	21.14	2.73
1300.0	20.91	31.32	12.76	19.40	1.68	0.96	38.40	21.17	2.70
1350.0	20.86	31.28	12.58	19.70	1.68	0.97	38.37	21.15	2.64
1400.0	20.81	31.05	12.43	19.93	1.65	0.97	38.16	21.17	2.62
1450.0	20.79	31.16	12.35	20.27	1.67	0.97	37.96	21.12	2.60
1500.0	20.75	30.99	12.20	20.45	1.64	0.97	38.18	21.00	2.56
1550.0	20.73	30.91	12.11	20.72	1.64	0.97	37.80	21.05	2.49
1600.0	20.71	30.80	12.01	20.95	1.62	0.97	37.67	21.04	2.49
1650.0	20.71	30.85	11.91	21.28	1.63	0.97	37.77	21.07	2.40
1700.0	20.72	30.78	11.87	21.47	1.61	0.97	37.88	21.13	2.37
1750.0	20.74	30.73	11.86	21.61	1.60	0.97	37.47	21.12	2.40
1800.0	20.75	30.71	11.93	21.75	1.60	0.97	37.41	21.13	2.26
1850.0	20.78	30.63	12.01	21.74	1.59	0.97	37.44	21.18	2.27
1900.0	20.81	30.54	12.06	21.95	1.57	0.96	37.44	21.17	2.27
1950.0	20.85	30.53	12.14	22.13	1.57	0.96	37.47	21.18	2.25
2000.0	20.88	30.48	12.22	22.18	1.56	0.96	37.09	21.24	2.19
2050.0	20.90	30.57	12.47	22.30	1.58	0.95	37.05	21.20	2.15
2100.0	20.93	30.57	12.58	22.24	1.57	0.95	36.97	21.20	2.13
2150.0	20.96	30.55	12.81	21.96	1.57	0.95	36.62	21.23	2.08

## Typical Performance Data

### Definitions:

Input Return Loss = -S11 (dB)

Gain(Power Gain) = S21 (dB)

Reverse Isolation = -S12 (dB)

Output Return Loss = -S22 (dB)

TEST CONDITIONS: Vd = 5.00V, Id=121.83mA @ Temperature = +85degC

FREQ	Gain	Isolation	Input Return Loss	Output Return Loss	Stability		IP-3 Output	1dB Comp. Output	Noise Figure
					K	Measure			
(MHz)	(dB)	(dB)	(dB)	(dB)	K	Measure	(dBm)	(dBm)	(dB)
900.0	20.18	32.41	10.83	15.30	1.93	1.00	37.10	20.70	3.96
950.0	20.21	32.26	11.40	15.97	1.92	0.99	37.02	20.73	3.92
960.0	20.21	32.08	11.51	16.09	1.89	0.99	36.59	20.76	3.93
970.0	20.21	32.09	11.61	16.25	1.90	0.99	37.30	20.62	3.92
980.0	20.20	32.00	11.68	16.37	1.88	0.99	37.18	20.54	3.91
990.0	20.20	31.94	11.75	16.54	1.87	0.99	37.04	20.64	3.95
1000.0	20.20	31.98	11.82	16.68	1.88	0.99	36.85	20.75	3.96
1050.0	20.16	31.70	12.10	17.45	1.85	0.98	36.81	20.73	3.94
1100.0	20.11	31.65	12.18	18.15	1.86	0.99	36.56	20.71	3.91
1150.0	20.04	31.48	12.11	18.76	1.84	0.99	36.71	20.73	3.88
1200.0	19.97	31.32	11.97	19.21	1.82	0.99	36.51	20.65	3.89
1250.0	19.89	31.15	11.75	19.61	1.80	0.99	36.41	20.61	3.85
1300.0	19.82	31.19	11.59	20.01	1.82	1.00	36.42	20.65	3.83
1350.0	19.75	31.02	11.44	20.45	1.80	1.00	36.34	20.62	3.75
1400.0	19.69	30.92	11.29	20.80	1.78	1.00	36.10	20.63	3.73
1450.0	19.65	30.92	11.19	21.07	1.79	1.01	35.89	20.56	3.74
1500.0	19.60	30.81	11.08	21.32	1.78	1.01	35.86	20.49	3.67
1550.0	19.56	30.74	10.97	21.47	1.77	1.01	35.82	20.56	3.63
1600.0	19.54	30.68	10.89	21.73	1.76	1.01	35.55	20.53	3.58
1650.0	19.52	30.63	10.85	22.16	1.75	1.01	35.78	20.56	3.53
1700.0	19.52	30.53	10.85	22.50	1.74	1.01	35.64	20.63	3.49
1750.0	19.52	30.55	10.87	22.83	1.75	1.01	35.34	20.60	3.46
1800.0	19.52	30.54	10.93	23.11	1.75	1.01	35.43	20.59	3.36
1850.0	19.53	30.47	11.00	23.10	1.74	1.00	35.37	20.63	3.38
1900.0	19.54	30.51	11.06	23.38	1.75	1.00	35.45	20.64	3.35
1950.0	19.56	30.39	11.18	23.50	1.73	1.00	35.29	20.64	3.37
2000.0	19.57	30.36	11.33	23.71	1.72	0.99	35.03	20.68	3.31
2050.0	19.59	30.51	11.57	23.52	1.75	0.99	35.08	20.63	3.22
2100.0	19.59	30.48	11.78	23.81	1.76	0.99	34.99	20.62	3.23
2150.0	19.59	30.56	12.04	23.34	1.78	0.98	35.11	20.65	3.16

## Typical Performance Data

### Definitions:

Input Return Loss = -S11 (dB)

Gain(Power Gain) = S21 (dB)

Reverse Isolation = -S12 (dB)

Output Return Loss = -S22 (dB)

TEST CONDITIONS: Vd = 4.75V, Id=120.86mA @ Temperature = +85degC

FREQ	Gain	Isolation	Input Return Loss	Output Return Loss	Stability		IP-3 Output	1dB Comp. Output	Noise Figure
					K	Measure			
(MHz)	(dB)	(dB)	(dB)	(dB)			(dBm)	(dBm)	(dB)
900.0	20.21	32.42	10.91	15.38	1.94	0.99	36.71	20.41	3.94
950.0	20.23	32.11	11.47	16.07	1.89	0.99	36.69	20.44	3.91
960.0	20.23	32.09	11.59	16.19	1.89	0.99	36.84	20.47	3.89
970.0	20.23	31.97	11.67	16.35	1.88	0.98	36.84	20.33	3.87
980.0	20.23	31.93	11.75	16.50	1.87	0.98	36.67	20.23	3.85
990.0	20.22	31.93	11.82	16.66	1.87	0.98	36.44	20.35	3.91
1000.0	20.22	31.87	11.89	16.82	1.87	0.98	36.42	20.46	3.93
1050.0	20.18	31.70	12.16	17.62	1.85	0.98	36.16	20.44	3.87
1100.0	20.13	31.55	12.23	18.37	1.84	0.98	36.14	20.42	3.86
1150.0	20.05	31.38	12.17	19.01	1.82	0.98	36.01	20.44	3.88
1200.0	19.98	31.15	12.02	19.50	1.79	0.99	35.95	20.35	3.85
1250.0	19.90	31.18	11.78	19.91	1.81	0.99	35.86	20.31	3.79
1300.0	19.83	31.05	11.63	20.39	1.80	1.00	36.01	20.35	3.81
1350.0	19.75	30.95	11.46	20.88	1.79	1.00	35.60	20.32	3.70
1400.0	19.70	30.89	11.32	21.25	1.78	1.00	35.45	20.32	3.71
1450.0	19.66	30.79	11.22	21.59	1.77	1.00	35.29	20.25	3.67
1500.0	19.60	30.70	11.11	21.81	1.76	1.00	35.34	20.18	3.65
1550.0	19.57	30.66	11.01	22.02	1.76	1.01	35.28	20.27	3.57
1600.0	19.54	30.65	10.93	22.27	1.76	1.01	35.13	20.23	3.55
1650.0	19.53	30.51	10.87	22.66	1.74	1.01	35.17	20.26	3.48
1700.0	19.53	30.46	10.87	22.99	1.73	1.01	35.14	20.34	3.44
1750.0	19.53	30.46	10.88	23.23	1.73	1.01	34.88	20.30	3.42
1800.0	19.53	30.40	10.95	23.45	1.72	1.00	34.82	20.29	3.31
1850.0	19.53	30.26	11.03	23.38	1.70	1.00	34.83	20.33	3.36
1900.0	19.55	30.35	11.09	23.48	1.72	1.00	34.83	20.34	3.31
1950.0	19.57	30.31	11.20	23.51	1.71	1.00	34.89	20.34	3.31
2000.0	19.59	30.29	11.35	23.54	1.71	0.99	34.61	20.38	3.24
2050.0	19.61	30.36	11.58	23.11	1.73	0.99	34.55	20.33	3.21
2100.0	19.60	30.26	11.80	23.19	1.72	0.98	34.68	20.32	3.15
2150.0	19.60	30.40	12.05	22.57	1.75	0.98	34.60	20.36	3.13

## Typical Performance Data

### Definitions:

Input Return Loss = -S11 (dB)

Gain(Power Gain) = S21 (dB)

Reverse Isolation = -S12 (dB)

Output Return Loss = -S22 (dB)

TEST CONDITIONS: Vd = 5.25V, Id=122.63mA @ Temperature = +85degC

FREQ	Gain	Isolation	Input Return Loss	Output Return Loss	Stability		IP-3 Output	1dB Comp. Output	Noise Figure
					K	Measure			
(MHz)	(dB)	(dB)	(dB)	(dB)			(dBm)	(dBm)	(dB)
900.0	20.17	32.37	10.79	15.25	1.92	1.00	37.40	20.98	4.03
950.0	20.20	32.16	11.36	15.91	1.90	0.99	36.96	21.02	3.95
960.0	20.20	32.11	11.47	16.01	1.89	0.99	36.69	21.04	3.97
970.0	20.20	32.23	11.58	16.18	1.92	0.99	37.63	20.91	3.95
980.0	20.19	32.11	11.64	16.30	1.90	0.99	37.52	20.83	3.98
990.0	20.20	31.99	11.72	16.43	1.88	0.99	36.95	20.93	4.02
1000.0	20.19	32.03	11.77	16.59	1.89	0.99	37.37	21.04	3.96
1050.0	20.16	31.77	12.08	17.32	1.86	0.99	37.02	21.02	3.94
1100.0	20.11	31.61	12.15	18.01	1.85	0.99	36.74	20.99	3.95
1150.0	20.03	31.43	12.08	18.60	1.83	0.99	36.86	21.02	3.90
1200.0	19.97	31.32	11.94	19.01	1.82	0.99	36.88	20.94	3.94
1250.0	19.89	31.29	11.72	19.35	1.82	1.00	36.65	20.91	3.87
1300.0	19.81	31.29	11.56	19.74	1.83	1.00	36.67	20.95	3.88
1350.0	19.75	31.07	11.41	20.14	1.80	1.00	36.58	20.92	3.77
1400.0	19.69	30.98	11.27	20.49	1.79	1.00	36.42	20.93	3.78
1450.0	19.65	30.92	11.18	20.76	1.79	1.01	36.28	20.85	3.77
1500.0	19.60	30.89	11.06	20.96	1.79	1.01	35.94	20.78	3.72
1550.0	19.56	30.75	10.96	21.14	1.77	1.01	35.98	20.85	3.64
1600.0	19.54	30.73	10.87	21.37	1.77	1.01	36.19	20.82	3.64
1650.0	19.52	30.64	10.82	21.75	1.75	1.01	35.92	20.86	3.53
1700.0	19.52	30.68	10.84	22.09	1.76	1.01	35.86	20.92	3.51
1750.0	19.52	30.52	10.86	22.48	1.74	1.01	35.62	20.89	3.51
1800.0	19.52	30.62	10.92	22.75	1.76	1.01	35.58	20.89	3.41
1850.0	19.52	30.58	11.00	22.83	1.76	1.01	35.47	20.92	3.42
1900.0	19.53	30.52	11.05	23.13	1.75	1.00	35.42	20.93	3.40
1950.0	19.55	30.53	11.18	23.41	1.75	1.00	35.55	20.93	3.40
2000.0	19.57	30.49	11.32	23.68	1.75	1.00	35.29	20.96	3.32
2050.0	19.58	30.63	11.60	23.68	1.78	0.99	35.41	20.91	3.24
2100.0	19.58	30.57	11.79	24.02	1.78	0.99	35.14	20.90	3.25
2150.0	19.57	30.74	12.02	23.81	1.81	0.99	35.57	20.94	3.20

## Typical Performance Curves

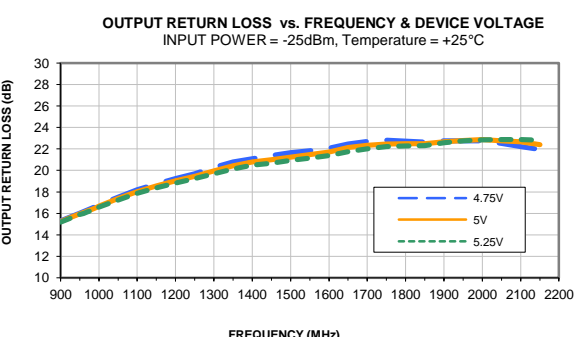
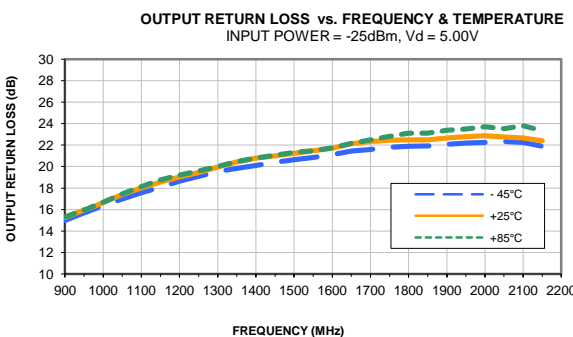
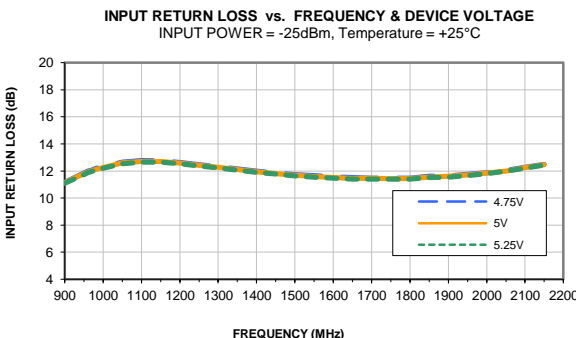
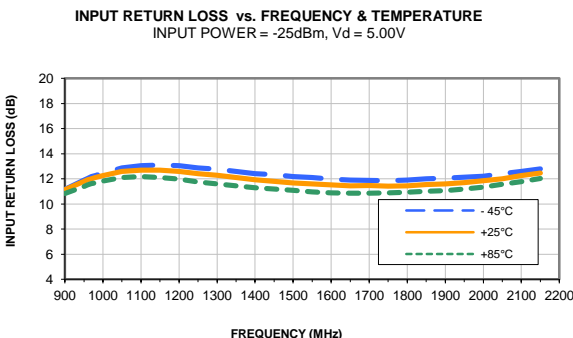
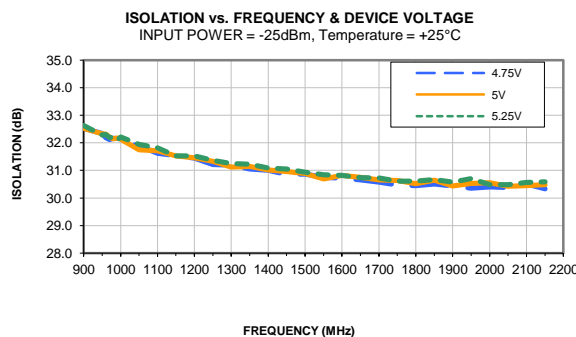
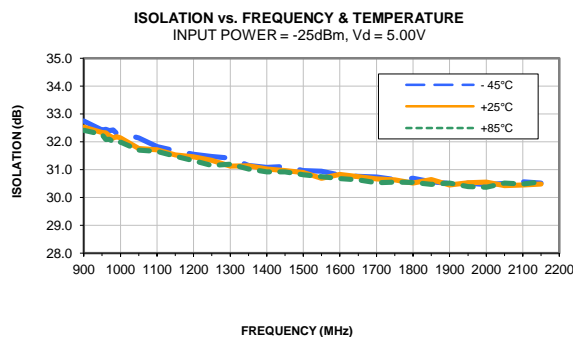
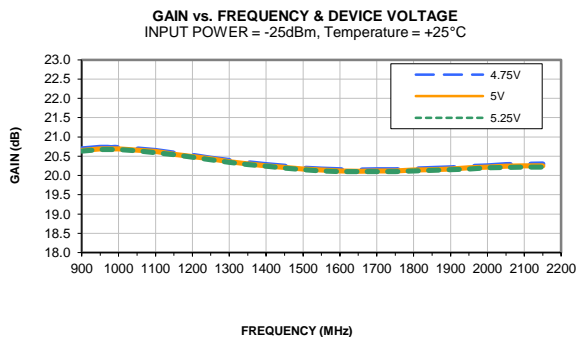
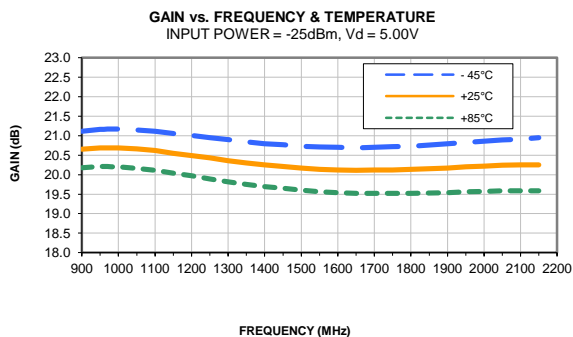

## Typical Performance Curves

**OUTPUT IP3 vs. FREQUENCY & TEMPERATURE**  
OUTPUT POWER = 2.5 dBm/tone, Vd = 5.00V

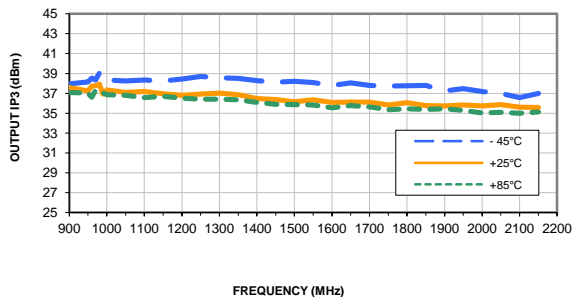

**OUTPUT IP3 vs. FREQUENCY & DEVICE VOLTAGE**  
OUTPUT POWER = 2.5 dBm/tone, Temperature = +25°C

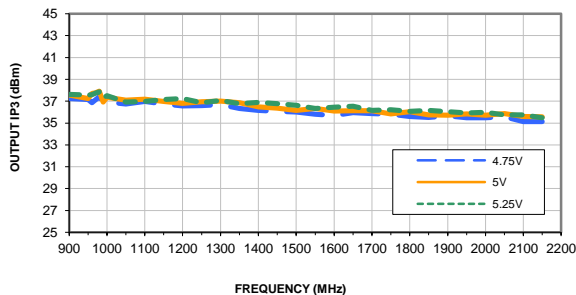

**P1dB vs. FREQUENCY & TEMPERATURE**  
Vd = 5.00V

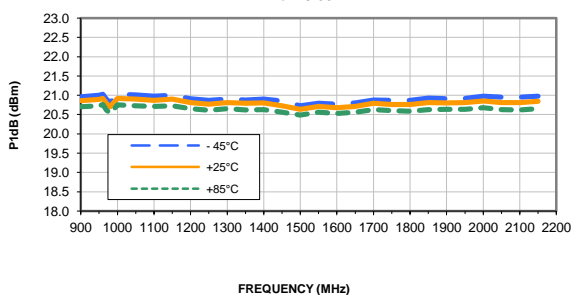

**P1dB vs. FREQUENCY & DEVICE VOLTAGE**  
Temperature = +25°C

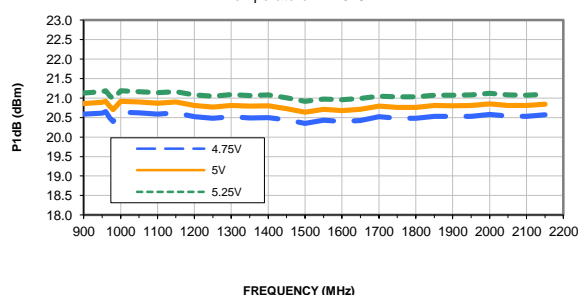

**NOISE FIGURE vs. FREQUENCY & TEMPERATURE**  
Vd = 5.00V

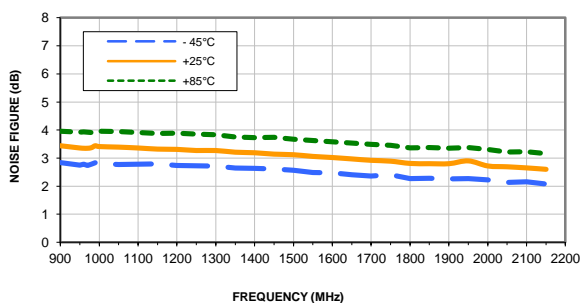

**NOISE FIGURE vs. FREQUENCY & DEVICE VOLTAGE**  
Temperature = +25°C

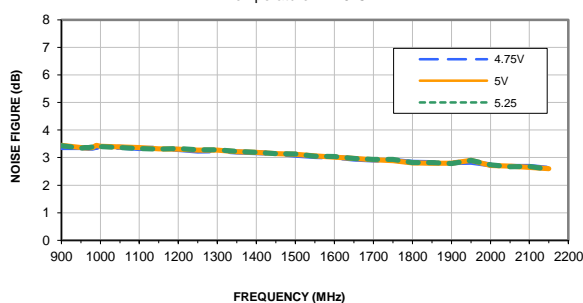

**GAIN VARIATION vs. FREQUENCY & TEMPERATURE**  
INPUT POWER = -25dBm, Vd = 5.00V

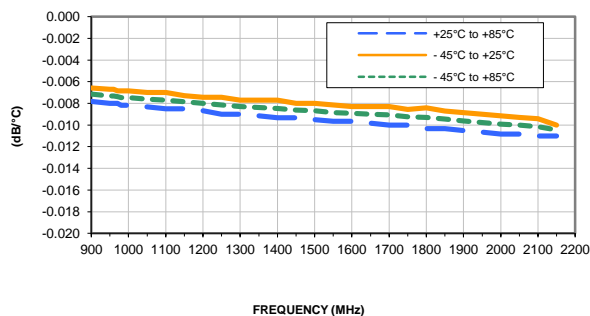



### Outline Dimensions

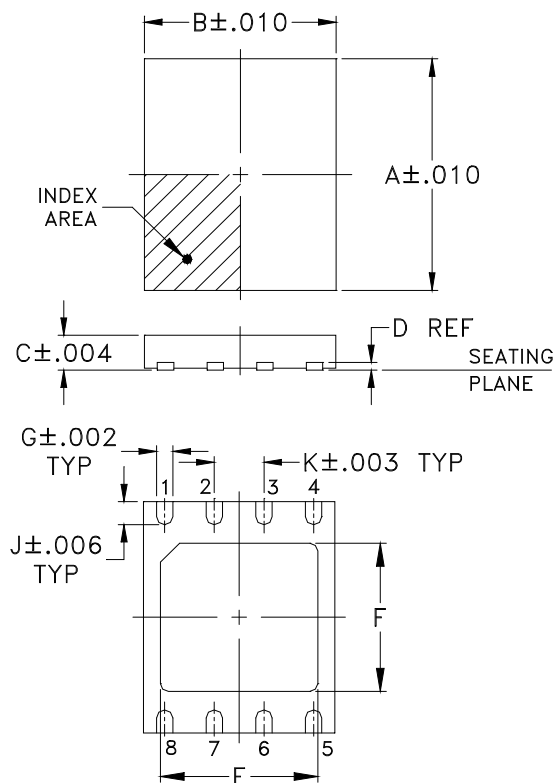

### PCB Land Pattern

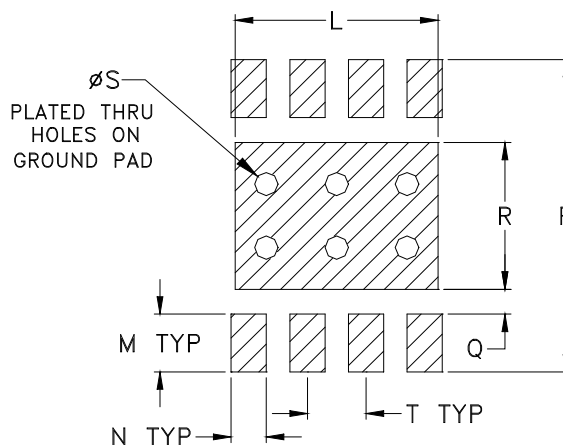

Suggested Layout,  
Tolerance to be within  $\pm .002$

CASE #	A	B	C	D	E	F	G	H	J	K	L	M	N
DL1636	.236 (6.00)	.193 (4.90)	.035 (0.90)	.008 (0.20)	.160 (4.05)	.153 (3.89)	.017 (0.42)	-- --	.024 (0.60)	.050 (1.27)	.162 (4.11)	.040 (1.02)	.020 (0.51)

CASE #	P	Q	R	S	T	WT. GRAM
DL1636	.257 (6.53)	.011 (0.28)	.155 (3.94)	.020 (0.51)	.050 (1.27)	.08

Dimensions are in inches (mm). Tolerances: 3Pl.  $\pm .004$ , unless otherwise specified.

#### Notes:

1. Case material: Plastic.
2. Termination finish:

For RoHS Case Styles: Tin-Silver-Nickel plate or Matte-Tin. All models, (+) suffix. See model data sheet.  
For RoHS-5 Case Styles: Tin-Lead plate. All models, no (+) suffix.



P.O. Box 350166, Brooklyn, New York 11235-0003 (718) 934-4500 Fax (718) 332-4661 For detailed performance specs & shopping online see Mini-Circuits web site



The Design Engineers Search Engine Provides ACTUAL Data Instantly From MINI-CIRCUITS At: [www.minicircuits.com](http://www.minicircuits.com)

RF/IF MICROWAVE COMPONENTS

# Tape & Reel Packaging TR-F68

## DEVICE ORIENTATION IN T&R

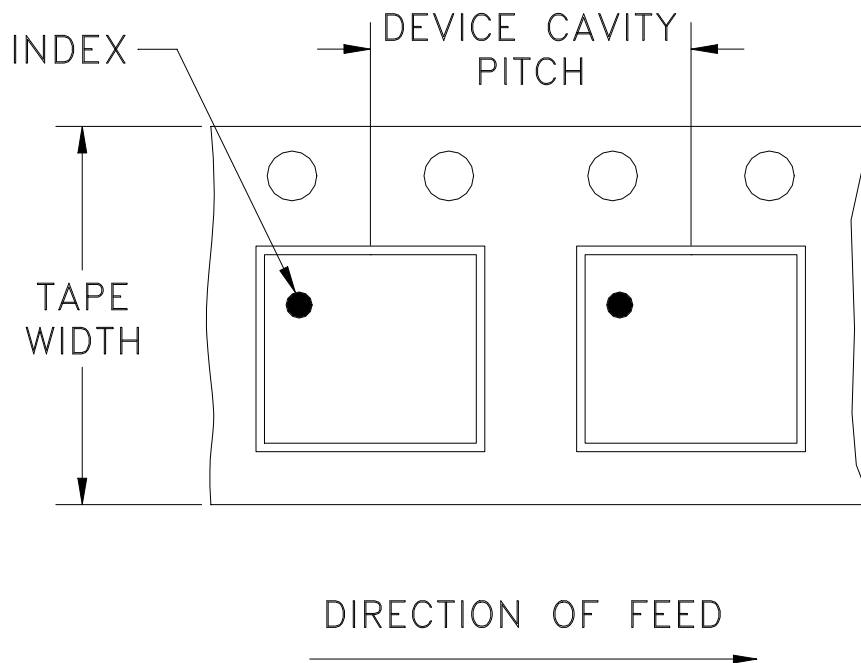

Tape Width, mm	Device Cavity Pitch, mm	Reel Size, inches	Devices per Reel see note	
12	8	7	Small quantity standard	20
				50
				100
				200
				500
		7	Standard	1000
		13	Standard	2000
				3000
				4000

Mini-Circuits carrier tape materials provide protection from ESD (Electro-Static Discharge) during handling and transportation. Tapes are static dissipative and comply with industry standards EIA-481/EIA-541.

Go to: [www.minicircuits.com/pages/pdfs/tape.pdf](http://www.minicircuits.com/pages/pdfs/tape.pdf)



INTERNET <http://www.minicircuits.com>

P.O. Box 350166, Brooklyn, New York 11235-0003 (718) 934-4500 Fax (718) 332-4661

Distribution Centers NORTH AMERICA 800-654-7949 • 417-335-5935 • Fax 417-335-5945 • EUROPE 44-1252-832600 • Fax 44-1252-837010

Mini-Circuits ISO 9001 & ISO 14001 Certified



# Evaluation Board and Circuit

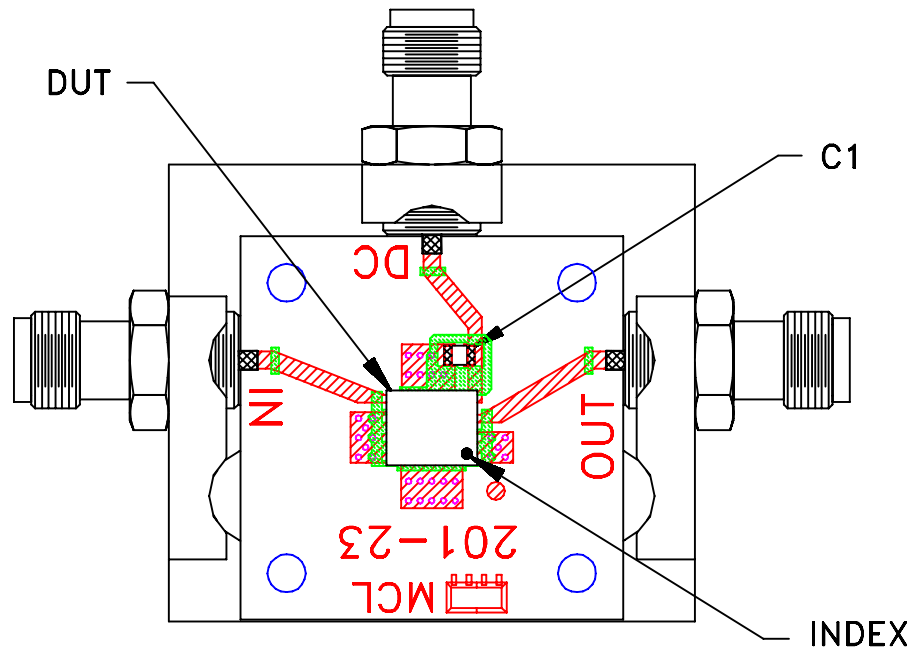

TB-616-7+

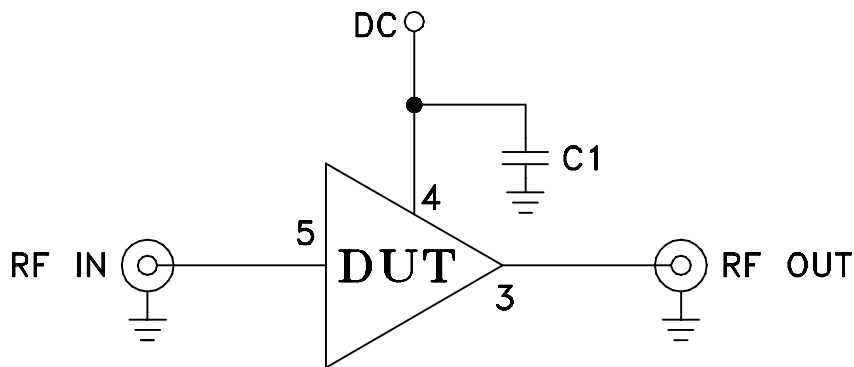

COMPONENT	VALUE
DUT	YSF-2151+
C1	1000 pF

## Schematic Diagram

### Notes:

1. 50 Ohm SMA Female connectors.
2. PCB Material: R04350 or equivalent,  
Dielectric Constant=3.5, Thickness=.020 inch.

 **Mini-Circuits®**

All Mini-Circuits products are manufactured under exacting quality assurance and control standards, and are capable of meeting published specifications after being subjected to any or all of the following physical and environmental test.

Specification	Test/Inspection Condition	Reference/Spec
Operating Temperature	-40° to 85°C Ambient Environment	Individual Model Data Sheet
Storage Temperature	-55° to 100° C or -65° to 150° Ambient Environment	Individual Model Data Sheet
Thermal Shock	-55° to 100°C, 100 cycles	MIL-STD-202, Method 107, Condition A-3, except +100°C
Mechanical Shock	1.5Kg, 0.5 ms, 5 shock pulses, Y1 direction only	MIL-STD-883, Method 2002, Condition B, except Y1 direction only
Vibration (Variable Frequency)	50g peak	MIL-STD-883, Method 2007, Condition B
Autoclave	15 psig, 100% RH, 121°C, 96 hours	JESD22-A102, Condition C
HAST	130°C, 85% RH, 96 hours	JESD22-A110
Solderability	10X Magnification	J-STD-002, Para 4.2.5, Test S, 95% Coverage
Solder Reflow Heat	Sn-Pb Eutetic Process: 240°C peak Pb-Free Process: 260°C peak	J-STD-020, Table 4-1, 4-2 and 5-2; Figure 5-1
Moisture Sensitivity: Level 1	Bake at 125°C for 24 hours Soak at 85°C/85% RH for 168 hours, Reflow 3 cycles at 260°C peak	J-STD-020
Marking Resistance to Solvents	Isopropyl alcohol + mineral spirits at 25°C; terpene defluxer at 25°C; distilled water + proylene glycol monomethyl ether +	MIL-STD-202, Method 215



All Mini-Circuits products are manufactured under exacting quality assurance and control standards, and are capable of meeting published specifications after being subjected to any or all of the following physical and environmental test.

Specification	Test/Inspection Condition	Reference/Spec
---------------	---------------------------	----------------

monoethanolamine at 63°C to 70°C