

3 Watt Cellular T/R and Antenna Changeover Switch DC - 3.0 GHz

Rev. V5

Features

- Low Insertion Loss: < 0.4 dB @ 1900 MHz
- Low Current Consumption: <20 μ A @ +5V
- High Intercept Point: 58 dBm @ 1 GHz
- Positive or Negative Voltage Control
- CDMA, W-CDMA, TDMA, GSM, PCS and DCS
- Lead-Free Plastic SOT-26 Package
- Halogen-Free "Green" Mold Compound
- 260°C Reflow Compatible
- RoHS* Compliant Version of SW-425

Description

The MASWSS0143 is a GaAs monolithic switch in a lead-free, SOT-26 surface mount plastic package. This device is ideally suited for applications where very low power consumption, low intermodulation products and very small size are required.

Typical applications include internal / external antenna select switch for portable telephones and data radios. In addition because of its low loss, good isolation, and inherent speed, the MASWSS0143 can be used as a conventional T/R switch or as an antenna diversity switch.

The MASWSS0143 can be used in power applications up to 3 watts in systems such as cellular PCS, CDMA, W-CDMA, TDMA, GSM and other analog / digital wireless communications systems.

The MASWSS0143 is fabricated using a 0.5 micron gate length GaAs pHEMT process. The process features full chip passivation for increased performance and reliability.

Ordering Information ¹

Part Number	Package
MASWSS0143	Bulk Packaging
MASWSS0143TR	1000 piece reel
MASWSS0143TR-3000	3000 piece reel

1. Reference Application Note M513 for reel size information.

Functional Block Diagram

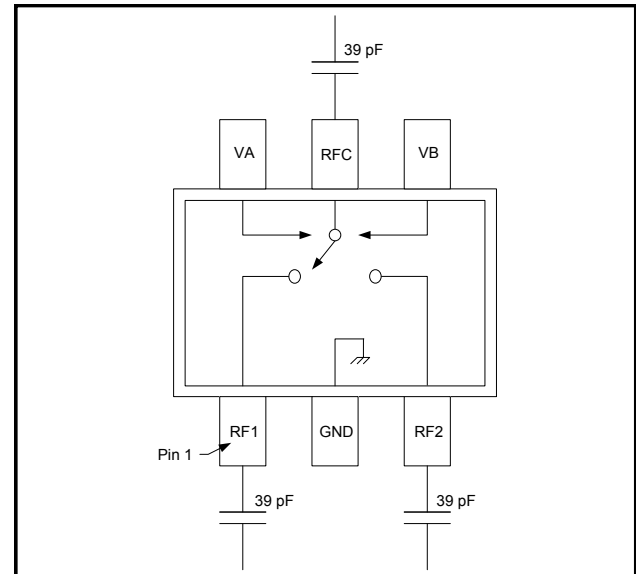

Pin Configuration

Pin No.	Function	Description
1	RF1	RF In/Out
2	GND	RF Ground
3	RF2	RF In/Out
4	VB	Voltage Control B
5	RFC	RF Common
6	VA	Voltage Control A

Absolute Maximum Ratings ^{2,3}

Parameter	Absolute Maximum
Input Power (1 GHz) 5 V Control	+36 dBm
Operating Temperature	-40°C to +85°C
Storage Temperature	-65°C to +150°C

2. Exceeding any one or combination of these limits may cause permanent damage to this device.
3. M/A-COM Technology does not recommend sustained operation near these survivability limits.

* Restrictions on Hazardous Substances, European Union Directive 2002/95/EC.

3 Watt Cellular T/R and Antenna Changeover Switch DC - 3.0 GHz

Rev. V5

Electrical Specifications: $T_A = 25^\circ\text{C}$, $V_{CTL} = 0/5\text{ V}$, $P_{IN} = 30\text{ dBm}$, $Z_0 = 50\ \Omega^4$

Parameters	Test Conditions	Units	Min.	Typ.	Max.
Insertion Loss	DC - 1 GHz	dB	—	0.35	0.50
	1 - 2 GHz	dB	—	0.40	—
	2 - 3 GHz	dB	—	0.65	—
Isolation	DC - 1 GHz	dB	18	22	—
	1 - 2 GHz	dB	—	16	—
	2 - 3 GHz	dB	—	11	—
VSWR	DC - 3 GHz	Ratio	—	1.2:1	—
P1dB	1 GHz	dBm	—	36	—
IP2	2-Tone, 5 MHz Spacing, 1 GHz Pin = +10 dBm / Tone	dBm	—	110	—
IP3	2-Tone, 5 MHz Spacing, 1 GHz Pin = +10 dBm / Tone	dBm	—	58	—
2nd Harmonics	Pin = +30 dBm, $f_0 = 1\text{ GHz}$	dBc	—	-78	—
3rd Harmonics	Pin = +30 dBm, $f_0 = 1\text{ GHz}$	dBc	—	-82	-70
Trise, Tfall	10% to 90% RF, 90% to 10% RF	ns	—	20	—
Ton, Toff	50% control to 90% RF, 50% control to 10% RF	ns	—	60	—
Transients		mV	—	20	—
Control Current	$V_{CTL} = 5\text{ V}$	mA	—	5	20

4. For positive voltage control, external DC blocking capacitors are required on all RF ports.

Truth Table ^{5,6}

Control A	Control B	RFC - RF1	RFC - RF2
0	1	Off	On
1	0	On	Off

5. Differential voltage, V (state 1) - V (state 0), must be +2.5 V minimum and must not exceed 8 V.

6. 0 = -8 V to 0 V, 1 = -5.5 V to 8.0 V

Handling Procedures

Please observe the following precautions to avoid damage:

Static Sensitivity

Gallium Arsenide Integrated Circuits are sensitive to electrostatic discharge (ESD) and can be damaged by static electricity. Proper ESD control techniques should be used when handling these devices.

Lead-Free SOT-26[†]

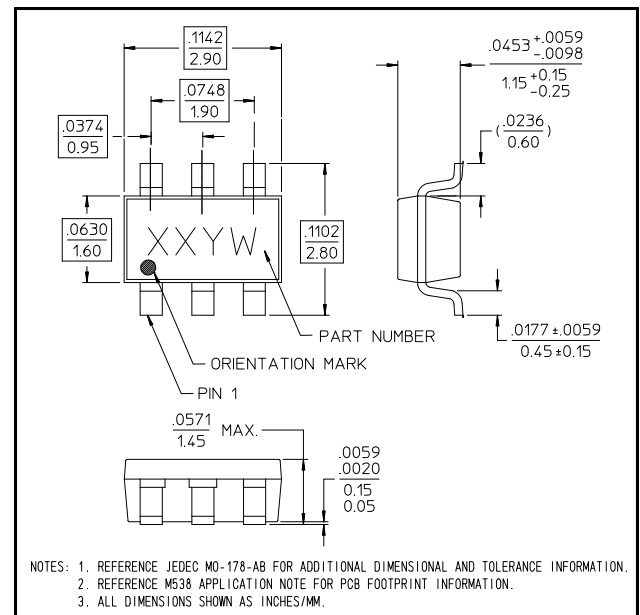

[†] Reference Application Note M538 for lead-free solder reflow recommendations.

Plating is 100% matte tin over copper.

3 Watt Cellular T/R and Antenna Changeover Switch DC - 3.0 GHz

Rev. V5

Typical Performance Curves

Insertion Loss, 1000 pF

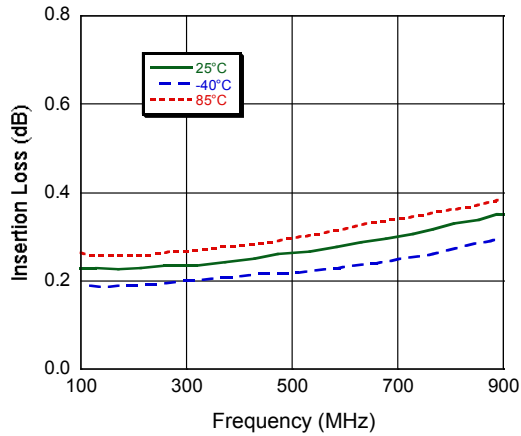

Insertion Loss, 39 pF

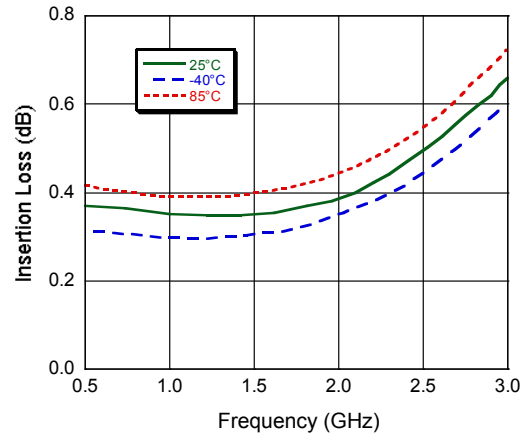

Isolation, 1000 pF

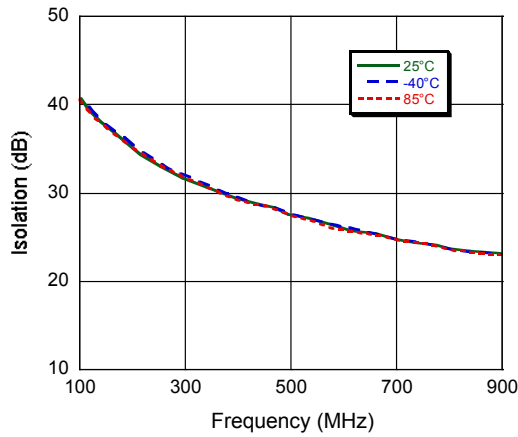

Isolation, 39 pF

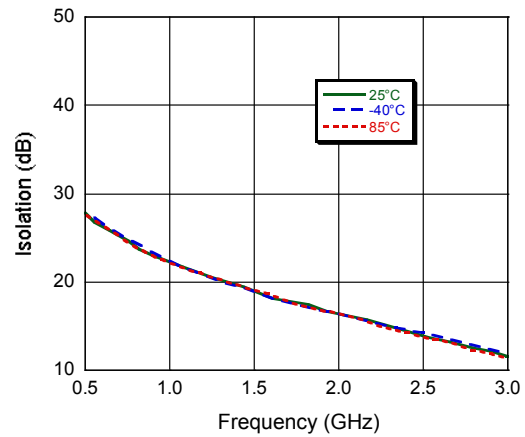

VSWR, 1000 pF

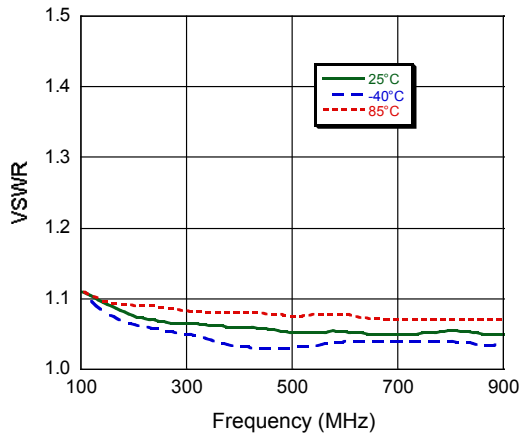

VSWR, 39 pF

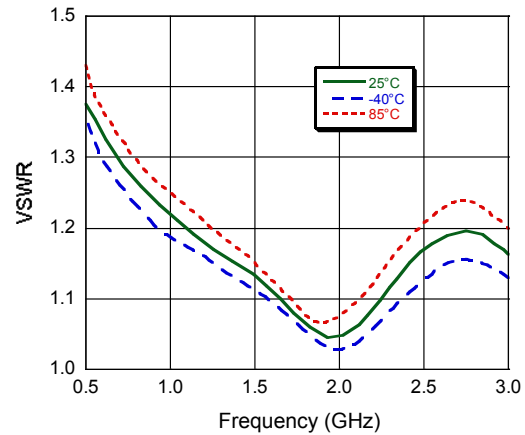

M/A-COM Technology Solutions Inc. All rights reserved.

Information in this document is provided in connection with M/A-COM Technology Solutions Inc ("MACOM") products. These materials are provided by MACOM as a service to its customers and may be used for informational purposes only. Except as provided in MACOM's Terms and Conditions of Sale for such products or in any separate agreement related to this document, MACOM assumes no liability whatsoever. MACOM assumes no responsibility for errors or omissions in these materials. MACOM may make changes to specifications and product descriptions at any time, without notice. MACOM makes no commitment to update the information and shall have no responsibility whatsoever for conflicts or incompatibilities arising from future changes to its specifications and product descriptions. No license, express or implied, by estoppel or otherwise, to any intellectual property rights is granted by this document.

THESE MATERIALS ARE PROVIDED "AS IS" WITHOUT WARRANTY OF ANY KIND, EITHER EXPRESS OR IMPLIED, RELATING TO SALE AND/OR USE OF MACOM PRODUCTS INCLUDING LIABILITY OR WARRANTIES RELATING TO FITNESS FOR A PARTICULAR PURPOSE, CONSEQUENTIAL OR INCIDENTAL DAMAGES, MERCHANTABILITY, OR INFRINGEMENT OF ANY PATENT, COPYRIGHT OR OTHER INTELLECTUAL PROPERTY RIGHT. MACOM FURTHER DOES NOT WARRANT THE ACCURACY OR COMPLETENESS OF THE INFORMATION, TEXT, GRAPHICS OR OTHER ITEMS CONTAINED WITHIN THESE MATERIALS. MACOM SHALL NOT BE LIABLE FOR ANY SPECIAL, INDIRECT, INCIDENTAL, OR CONSEQUENTIAL DAMAGES, INCLUDING WITHOUT LIMITATION, LOST REVENUES OR LOST PROFITS, WHICH MAY RESULT FROM THE USE OF THESE MATERIALS.

MACOM products are not intended for use in medical, lifesaving or life sustaining applications. MACOM customers using or selling MACOM products for use in such applications do so at their own risk and agree to fully indemnify MACOM for any damages resulting from such improper use or sale.