

Digital Controlled Variable Gain Amplifier

DVGA1-242A+

50Ω 0.45 to 2.4 GHz
31.5 dB, 0.5 dB Step, 6 Bit Serial Control

The Big Deal

- Integrated Amplifier and Digital Attenuator
- 30 dB Gain / 31.5 dB Gain Control
- High Output IP3, 35-37 dBm

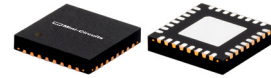

CASE STYLE: DG1677

Product Overview

The DVGA1-242A+ is a 50Ω RF Digital Variable Gain Amplifier that offers an attenuation of 31.5 dB in 0.5 dB steps using a 6-bit serial interface attenuator and 30dB gain using a E-PHEMT amplifier. Step attenuator used in DVGA1-242A+ is produced using a unique combination of CMOS process on silicon, offering the performance of GaAs, with the advantages of conventional CMOS devices.

Key Features

Feature	Advantages
31.5 dB attenuation in 0.5 dB step size	Combining high gain and a wide range of gain control makes the DVGA1-242A+ an ideal building block for any RF chain where level setting control is required in a small space.
High Gain, 30 dB	Incorporating multiple stages of amplification, the DVGA1-242A+ provides high gain reducing cost and PCB board space
High IP3, +35.1 dBm at 1.0 GHz Low Noise Figure, 2.2 dB at 1.0 GHz	Combining Low Noise and High IP3 makes this MMIC amplifier ideal for Low Noise Receiver Front End (RFE) giving the user advantages at both ends of the dynamic range: sensitivity & two-tone IM dynamic range.
Output Power, +22.7 dBm at 2.4 GHz	The DVGA1-242A+ maintains consistent output power capability over the full operating temperature range making it ideal to be used in remote applications such as LNB's as the L Band driver stage.
MCLP Package	Low Inductance, repeatable transitions, excellent thermal pad.
Max Input Power, +24 dBm	Ruggedized design operates up to input powers often seen at Receiver inputs.
Attenuation Step size, 0.5 dB, accuracy 0.1 dB typ. Total attenuation, 31.5 dB	Enables precise control of gain in 0.5 dB steps up to 31.5 dB.
External Jumper	Customer access is provided between the digital attenuator and the RF amplifier to allow the user to integrate external circuit elements if desired.

Digital Controlled Variable Gain Amplifier

50Ω 450-2400 MHz

30 dB Gain, 0.5 dB Step, 31.5 dB Attenuation,
6 Bit Serial Control

Product Features

- 31.5 dB Gain control 0.5dB step size
- Gain, 30 dB nominal at 0dB attenuation and 1 GHz
- Excellent accuracy, 0.1 dB typ
- Serial control interface
- Small size 5.0 x 5.0 mm

Typical Applications

- Base Station Infrastructure
- GPS
- LTE
- WCDMA

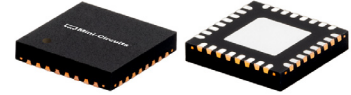

Generic photo used for illustration purposes only

CASE STYLE: DG1677

DVGA1-242A+

+RoHS Compliant

The +Suffix identifies RoHS Compliance. See our web site for RoHS Compliance methodologies and qualifications

General Description

The DVGA1-242A+ is a 50Ω RF Digital Variable Gain Amplifier that offers an attenuation of 31.5 dB in 0.5 dB steps using a 6-bit serial interface attenuator and 30dB gain using a E-PHEMT amplifier. Step attenuator used in DVGA1-242A+ is produced using a unique combination of CMOS process on silicon, offering the performance of GaAs, with the advantages of conventional CMOS devices.

Simplified Schematic

(Refer to Table 1 for Pad description)

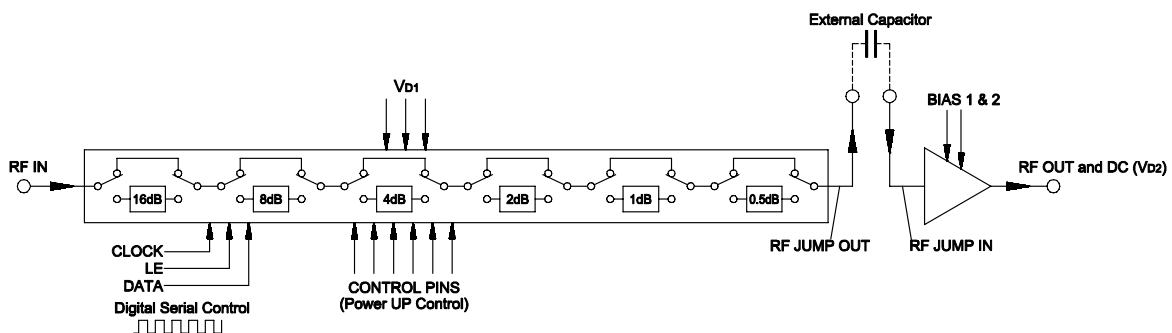

RF Electrical Specifications⁽¹⁾ at 25°C, 50Ω With V_{D1}=+3.0V, V_{D2}=+5V

Parameter	Condition (GHz)	Min.	Typ.	Max.	Units
Frequency Range		0.45		2.4	GHz
Gain (at 0 dB attenuation)	.45	—	29.6	—	dB
	1.0	—	30.5	—	
	1.4	26.5	29.3	32.4	
	2.0	—	24.3	—	
	2.4	—	21.0	—	
Input Return Loss (all states)	.45	—	17.3	—	dB
	1.0	—	20.2	—	
	1.4	—	7.6	—	
	2.0	—	7.7	—	
	2.4	—	11.4	—	
Output Return Loss (all states)	.45	—	21.0	—	dB
	1.0	—	13.4	—	
	1.4	—	12.1	—	
	2.0	—	9.8	—	
	2.4	—	9.9	—	
Output Power @ 1 dB compression (at min and max attenuation)	.45	—	22.1	—	dBm
	1.0	—	22.4	—	
	1.4	20.0	22.9	—	
	2.0	—	22.9	—	
	2.4	—	22.7	—	
Output IP3 (all states)	.45	—	35.7	—	dBm
	1.0	—	35.1	—	
	1.4	—	35.9	—	
	2.0	—	37.6	—	
	2.4	—	37.4	—	
Noise Figure (at 0 dB attenuation)	.45	—	2.2	—	dB
	1.0	—	2.2	—	
	1.4	—	2.4	3.7	
	2.0	—	2.6	—	
	2.4	—	2.9	—	
Accuracy @ 0.5 dB Attenuation Setting	.45 - 1.0	—	0.03	0.12	dB
	1.0 - 2.4	—	0.1	0.18	
Accuracy @ 1 dB Attenuation Setting	.45 - 1.0	—	0.05	0.13	dB
	1.0 - 2.4	—	0.15	0.2	
Accuracy @ 2 dB Attenuation Setting	.45 - 1.0	—	0.06	0.25	dB
	1.0 - 2.4	—	0.24	0.37	
Accuracy @ 4 dB Attenuation Setting	.45 - 1.0	—	0.09	0.37	dB
	1.0 - 2.4	—	0.31	0.45	
Accuracy @ 8 dB Attenuation Setting	.45 - 1.0	—	0.2	0.4	dB
	1.0 - 2.4	—	0.49	0.7	
Accuracy @ 16 dB Attenuation Setting	.45 - 1.0	—	0.2	0.6	dB
	1.0 - 2.4	—	0.73	1.2	

1. Measured in Mini-Circuits characterization test board TB-643A+. See characterization Test Circuit (Fig. 2)

Attenuation Switching Specifications

Parameter	Min.	Typ.	Max.	Units
Switching Speed, 50% Control to 0.5dB of Attenuation Value	—	1.0	—	μSec
Switching Rep Rate	—	—	25	KHz

Figure 1. Switching Speed

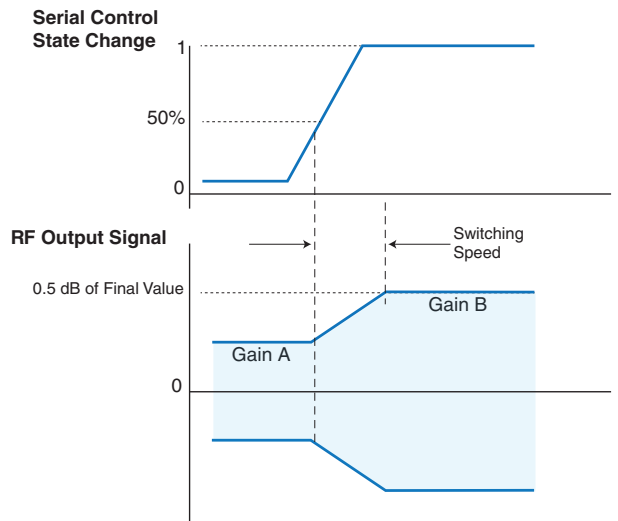

DC Electrical Specifications

Parameter	Min.	Typ.	Max.	Units
Supply Voltage, V_{D1}	2.7	3.0	3.3	V
V_{D2}	4.75	5.0	5.25	V
Supply Current, I_{D1}	—	—	200	μA
I_{D2}	—	154	186	mA
Control Input Low	-0.3	—	0.6	V
Control Input High	1.17	—	3.6	V
Control Current*	—	—	20	μA

* Except 30 μA typ. for C 0.5, C16

Absolute Maximum Ratings

Parameter	Ratings
Operating Temperature	-40°C to 85°C
Storage Temperature	-65°C to 150°C
V_{D1}	-0.3V Min., 5.5V Max.
V_{D2}	6.0V
Voltage on any control input**	-0.3V Min., $V_{D1}+0.3V$ Max.
Input Power	+24dBm

** Permanent damage may occur if any of these limits are exceeded.

Table 1. Pad Description

Pin Number	Function	Description
1	N/C	Not Connected
2	RF IN	RF Input Port (Note 1)
3	N/C	Not Connected
4	N/C	Not Connected
5	DATA	Serial Interface Data Input (Note 3)
6	CLOCK	Serial Interface Clock Input
7	LE	Latch Enable Input (Note 2)
8	V _{D1}	V _{D1} Power Supply Input
9	N/C	Not Connected
10	N/C	Not Connected
11	V _{D1}	V _{D1} Power Supply Input
12	GND	Ground
13	V _{D1}	V _{D1} Power Supply Input
14	N/C	Not Connected
15	N/C	Not Connected
16	N/C	Not Connected
17	RF OUT & V _{D2}	RF output and V _{D2} on same pad (external Bias Tee) (Note1,6)
18	N/C	Not Connected
19	BIAS 2	Amplifier Bias 2 connects to V _{D2}
20	BIAS 1	Amplifier Bias 1 connects to V _{D2} via inductor(Note1,6)
21	N/C	Not Connected
22	RF JUMP IN	Interstage RF Jumper Input (Note 1)
23	RF JUMP OUT	Interstage RF Jumper Output (Note 1)
24	N/C	Not Connected
25	N/C	Not Connected
26	C8	Power Up Control for 8dB Att. Bit (Note 4)
27	C4	Power Up Control for 4dB Att. Bit (Note 4)
28	C2	Power Up Control for 2dB Att. Bit (Note 4)
29	C1	Power Up Control for 1dB Att. Bit (Note 4)
30	C0.5	Power Up Control for 0.5dB Att. Bit (Note 4)
31	C16	Power Up Control for 16dB Att. Bit (Note 4)
32	N/C	Not Connected
PADDLE	GND	Ground (Note5)

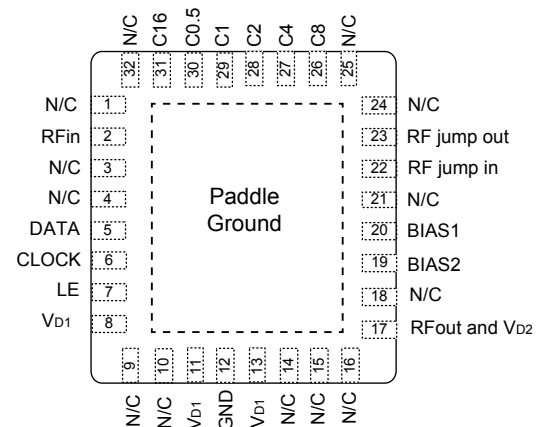

Notes:

1. All RF input and output ports shall be AC coupled with external blocking capacitor.
2. Latch Enable (LE) has an internal 100KΩ pull-up resistor to V_{D1}.
3. Place a 10KΩ resistor in series, as close to pin as possible to avoid freq. resonance (see layout drawing PL-355).
4. Refer to Power-up Control Settings.
5. The exposed solder pad on the bottom of the package (See Pin Configuration) must be grounded for proper device operation.
6. See application and characterization test circuit and layout drawing PL-355.

Application and Characterization Test Circuit

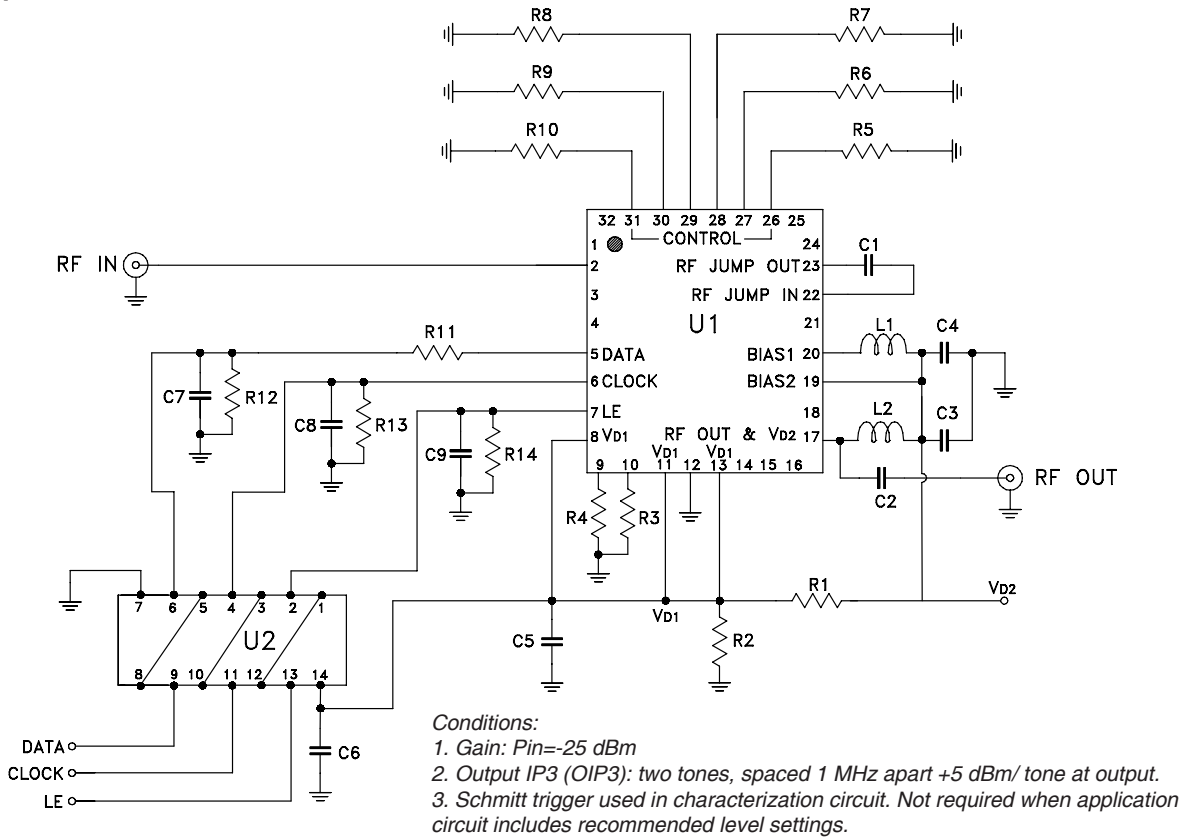
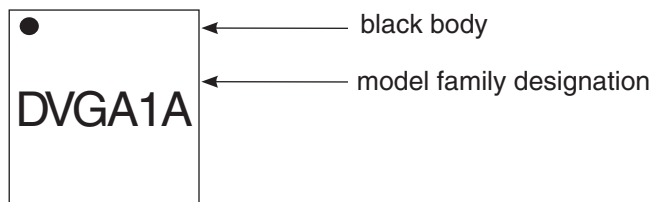

Figure 2. Schematic of Test Circuit used for Characterization. (DUT soldered on Mini-Circuits Characterization Test Board TB-643A+). Gain, output power at 1 dB compression (P1dB) Output IP3 (OIP3), Noise Figure are measured using Agilent's N5242A PNA-X Microwave Network Analyzer.

Bill of Materials

Ref. Des.	Value / Description	Case Style, Size
C1, C4	100pF	0402
C2	100pF	0805
C3	1uF	0805
C5, C7, C8, C9	100pF	0603
C6	0.47uF	0805
L1	36nH	0402
L2	47nH	0402
R1	475Ω	0603
R2	681Ω	0603
R3 ~ R14	10kΩ	0603
U2	HEX Inverter Trigger Fairchild P/N MM74HC14M	
U1	DVGA1-242A+	

Product Marking



Simplified Schematic

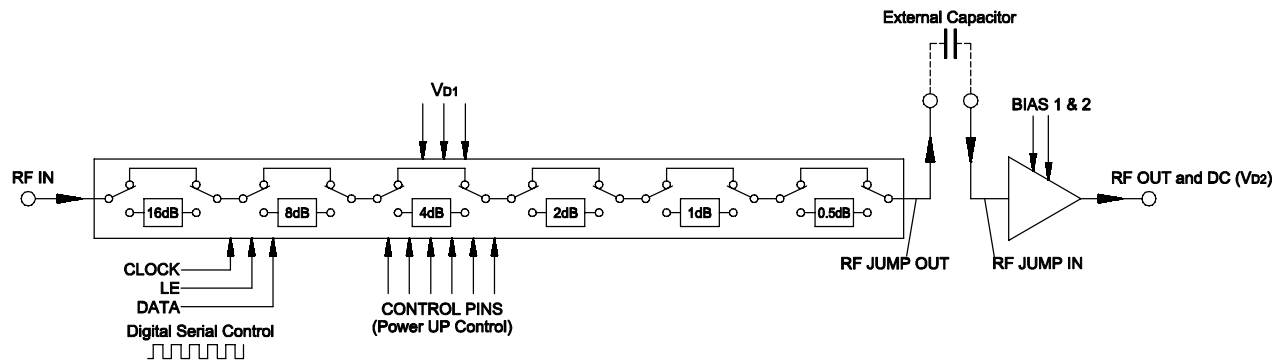

Figure 3. The DVGA1-242A+ Serial interface consists of 6 control bits that select the desired attenuation state, as shown in Table 2 Truth Table.

Table 2. Truth Table

Attenuation State	C16	C8	C4	C2	C1	C0.5
Reference	0	0	0	0	0	0
0.5 (dB)	0	0	0	0	0	1
1 (dB)	0	0	0	0	1	0
2 (dB)	0	0	0	1	0	0
4 (dB)	0	0	1	0	0	0
8 (dB)	0	1	0	0	0	0
16 (dB)	1	0	0	0	0	0
31.5 (dB)	1	1	1	1	1	1

Note: Not all 64 possible combinations of C0.5 - C16 are shown in table

The serial interface is a 6-bit serial in, parallel-out shift register buffered by a transparent latch. It is controlled by three CMOS-compatible signals: Data, Clock, and Latch Enable (LE). The Data and Clock inputs allow data to be serially entered into the shift register, a process that is independent of the state of the LE input. The LE input controls the latch. When LE is HIGH, the latch is transparent and the contents of the serial shift register control the attenuator. When LE is brought LOW, data in the shift register is latched. The shift register should be loaded while LE is held LOW to prevent the attenuator value from changing as data is entered. The LE input should then be toggled HIGH and brought LOW again, latching the new data. The timing for this operation is defined by Figure 4 (Serial Interface Timing Diagram) and Table 3 (Serial Interface AC Characteristics).

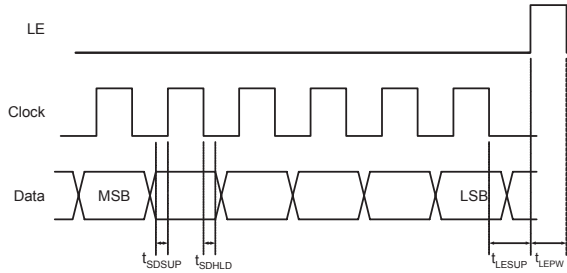

Figure 4. Serial Interface Timing Diagram

Table 3. Serial Interface AC Characteristics (V_{D1}=3V)

Symbol	Parameter	Min.	Max.	Units
f _{clk}	Serial data clock frequency (Note 1)		10	MHz
t _{clkH}	Serial clock HIGH time	30		ns
t _{clkL}	Serial clock LOW time	30		ns
t _{LESUP}	LE set-up time after last clock falling edge	10		ns
t _{LEPW}	LE minimum pulse width	30		ns
t _{SDSUP}	Serial data set-up time before clock rising edge	10		ns
t _{SDHLD}	Serial data hold time after clock falling edge	10		ns

Note 1. f_{clk} verified during the functional pattern test. Serial programming sections of the functional pattern are clocked at 10MHz to verify f_{clk} specification.

The DVGA1-242A+, uses a common 6-bit serial, as shown in Table 4: 6-Bit attenuator Serial Programming Register Map. The first bit, the MSB, corresponds to the 16-dB Step and the last bit, the LSB, corresponds to the 0.5dB step.

B5	B4	B3	B2	B1	B0
C16	C8	C4	C2	C1	C0.5

↑
MSB
(first in)

↑
LSB
(last in)

Power-up Control Settings

The DVGA1-242A+ always assumes a specifiable attenuation setting on power-up, allowing a known attenuation state to be established before an initial serial control word is provided. When the attenuator powers up, the six control bits are set to whatever data is present on the six control inputs (C0.5 to C16). This allows any one of the 64 attenuation settings to be specified as the power-up state.

Additional Detailed Technical Information <i>additional information is available on our dash board. To access this information click here</i>	
Performance Data	Data Table
	Swept Graphs
	S-Parameter (S2P Files) Data Set (.zip file)
Case Style	DG1677 Plastic package, exposed paddle, lead finish: Ni/Pd/Au
Tape & Reel Standard quantities available on reel	F68 7" reels with 20,50,100,200, 500 or 1K devices
Suggested Layout for PCB Design	PL-355
Evaluation Board	TB-643A+
Environmental Ratings	ENV66

ESD Rating

Human Body Model (HBM): Class 1A (250 to <500V) in accordance with ANSI/ESD STM 5.1 - 2001
Machine Model (MM): Class M1 (40V) in accordance with ANSI/ESD STM5.2-1999

MSL Rating

Moisture Sensitivity: MSL1 in accordance with IPC/JEDEC J-STD-020D

MSL Test Flow Chart

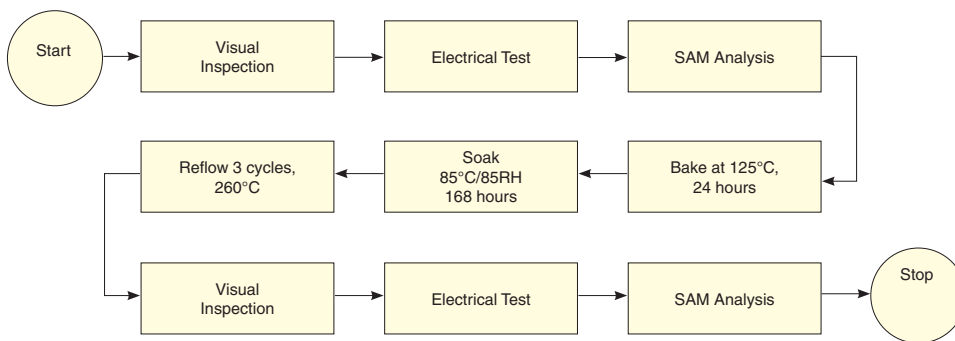

Additional Notes

- A. Performance and quality attributes and conditions not expressly stated in this specification document are intended to be excluded and do not form a part of this specification document.
- B. Electrical specifications and performance data contained in this specification document are based on Mini-Circuit's applicable established test performance criteria and measurement instructions.
- C. The parts covered by this specification document are subject to Mini-Circuits standard limited warranty and terms and conditions (collectively, "Standard Terms"); Purchasers of this part are entitled to the rights and benefits contained therein. For a full statement of the Standard Terms and the exclusive rights and remedies thereunder, please visit Mini-Circuits' website at www.minicircuits.com/MCLStore/terms.jsp

Digital Variable Gain Amplifier

DVGA1-242A+

Typical Performance Data

TEST CONDITIONS: Vd1 = +3V, Vd2 = +5V @ Temperature = +25degC

FREQ	GAIN @ 0dB Step	STEP ATTENUATION @							Output IP3 @ 0dB Step	Pout at 1dB Comp @ 0dB Step	Noise Figure @ 0dB Step
		0.5 dB	1.0 dB	2 dB	4 dB	8 dB	16 dB	31.5 dB			
(MHz)	(dB)	(dB)	(dB)	(dB)	(dB)	(dB)	(dB)	(dB)	(dBm)	(dBm)	(dB)
400	29.41	0.52	1.01	1.97	3.94	7.86	15.85	31.14	36.64	21.75	2.25
500	29.90	0.52	1.01	2.01	4.01	7.98	15.99	31.37	36.28	22.44	2.10
600	30.15	0.53	1.04	2.05	4.07	8.08	16.09	31.45	36.37	22.23	2.14
700	30.20	0.54	1.05	2.05	4.07	8.10	16.16	31.48	36.22	22.34	2.12
800	30.29	0.53	1.05	2.01	4.03	8.07	16.13	31.42	36.42	22.45	2.11
900	30.37	0.53	1.05	1.99	4.01	8.05	16.14	31.38	36.59	22.70	2.12
1000	30.49	0.53	1.05	1.97	3.99	8.01	16.10	31.34	36.21	22.67	2.24
1200	30.24	0.51	1.00	1.91	3.87	7.81	15.82	31.10	36.68	22.82	2.33
1400	29.28	0.49	0.96	1.89	3.80	7.61	15.48	30.86	37.27	23.08	2.40
1600	27.80	0.50	0.95	1.93	3.82	7.60	15.36	30.82	37.93	23.14	2.48
1800	26.07	0.51	0.98	2.02	3.95	7.80	15.60	31.02	38.23	23.15	2.62
2000	24.30	0.55	1.05	2.13	4.10	8.06	15.97	31.24	38.78	22.98	2.63
2200	22.50	0.57	1.10	2.17	4.20	8.27	16.28	31.46	39.23	22.81	2.75
2400	20.89	0.60	1.16	2.23	4.31	8.47	16.59	31.79	38.52	22.75	2.86



P.O. Box 350166, Brooklyn, New York 11235-0003 (718) 934-4500 • Fax (718) 332-4661 For detailed performance specs & shopping online see Mini-Circuits web site



The Design Engineers Search Engine Provides ACTUAL Data Instantly From MINI-CIRCUITS At: www.minicircuits.com

IF/RF MICROWAVE COMPONENTS

REV. OR
DVGA1-242A+
5/6/2016

Page 1 of 9

Typical Performance Data

TEST CONDITIONS: Vd1 = +3V, Vd2 = +5V @ Temperature = -40degC

FREQ	GAIN @ 0dB Step	STEP ATTENUATION @							Output IP3 @ 0dB Step	Pout at 1dB Comp @ 0dB Step	Noise Figure @ 0dB Step
		0.5 dB	1.0 dB	2 dB	4 dB	8 dB	16 dB	31.5 dB			
(MHz)	(dB)	(dB)	(dB)	(dB)	(dB)	(dB)	(dB)	(dB)	(dBm)	(dBm)	(dB)
400	29.71	0.49	1.01	1.96	3.93	7.90	15.84	31.26	41.52	22.59	1.81
500	30.52	0.50	1.02	2.03	4.03	8.04	16.04	31.51	41.50	22.89	1.64
600	31.00	0.52	1.04	2.06	4.10	8.15	16.15	31.63	40.79	22.51	1.62
700	31.17	0.53	1.05	2.06	4.11	8.18	16.22	31.67	40.78	22.56	1.54
800	31.35	0.50	1.02	2.02	4.06	8.11	16.17	31.58	40.19	22.65	1.52
900	31.48	0.50	1.02	1.98	4.00	8.07	16.13	31.52	40.78	22.92	1.52
1000	31.66	0.50	1.04	1.95	3.97	8.03	16.08	31.44	40.85	22.86	1.58
1200	31.52	0.49	1.00	1.90	3.87	7.86	15.85	31.22	40.51	23.08	1.69
1400	30.65	0.48	0.95	1.90	3.84	7.73	15.58	31.03	40.60	23.40	1.75
1600	29.21	0.50	0.96	2.01	3.93	7.81	15.59	31.07	40.80	23.47	1.82
1800	27.50	0.52	1.03	2.13	4.11	8.08	15.89	31.27	41.04	23.54	1.87
2000	25.76	0.57	1.09	2.23	4.28	8.36	16.26	31.58	42.35	23.46	1.97
2200	23.95	0.56	1.12	2.27	4.38	8.54	16.55	31.72	41.98	23.39	1.99
2400	22.34	0.60	1.19	2.33	4.48	8.77	16.86	31.96	41.75	23.42	2.11

Typical Performance Data

TEST CONDITIONS: Vd1 = +3V, Vd2 = +5V @ Temperature = +85degC

FREQ	GAIN @ 0dB Step	STEP ATTENUATION @							Output IP3 @ 0dB Step	Pout at 1dB Comp @ 0dB Step	Noise Figure @ 0dB Step
		0.5 dB	1.0 dB	2 dB	4 dB	8 dB	16 dB	31.5 dB			
(MHz)	(dB)	(dB)	(dB)	(dB)	(dB)	(dB)	(dB)	(dB)	(dBm)	(dBm)	(dB)
400	29.00	0.49	0.99	1.94	3.92	7.83	15.80	31.02	32.91	20.24	2.74
500	29.24	0.51	0.99	1.98	3.96	7.90	15.89	31.16	33.02	21.02	2.69
600	29.30	0.49	1.00	2.00	3.99	7.97	16.00	31.23	33.17	21.02	2.73
700	29.26	0.51	1.02	2.00	4.02	8.01	16.08	31.27	33.28	21.16	2.69
800	29.31	0.51	1.01	1.99	3.99	8.01	16.12	31.25	33.38	21.32	2.70
900	29.34	0.50	1.02	1.96	3.98	8.01	16.12	31.27	33.46	21.56	2.76
1000	29.44	0.51	1.03	1.96	3.98	8.01	16.13	31.24	33.23	21.52	2.83
1200	29.16	0.48	0.98	1.89	3.85	7.79	15.82	31.06	33.77	21.76	3.01
1400	28.13	0.46	0.91	1.85	3.73	7.52	15.38	30.74	34.37	22.17	3.08
1600	26.64	0.47	0.90	1.86	3.70	7.43	15.20	30.65	34.90	22.34	3.22
1800	24.87	0.47	0.92	1.91	3.79	7.56	15.33	30.72	35.36	22.38	3.28
2000	23.07	0.49	0.98	1.98	3.90	7.77	15.65	30.94	35.73	22.21	3.39
2200	21.32	0.53	1.04	2.05	4.03	8.01	16.02	31.22	35.52	21.90	3.48
2400	19.68	0.55	1.08	2.11	4.11	8.19	16.31	31.46	35.02	21.54	3.59

Typical Performance Data

TEST CONDITIONS: Vd1 = +3V, Vd2 = +5V @ Temperature = +25degC

FREQ	INPUT RETURN LOSS @							
	0 dB	0.5 dB	1 dB	2 dB	4 dB	8 dB	16 dB	31.5 dB
(MHz)	(dB)	(dB)	(dB)	(dB)	(dB)	(dB)	(dB)	(dB)
400	18.93	20.05	21.36	21.10	21.84	23.72	34.38	37.26
500	16.01	17.55	18.79	18.19	19.29	22.35	33.62	37.33
600	15.28	16.48	17.88	17.56	19.24	22.15	30.97	32.78
700	16.00	17.66	18.77	18.84	20.56	22.78	30.34	30.47
800	18.61	20.06	21.83	22.41	23.70	24.27	29.56	28.52
900	21.58	22.73	24.23	33.69	29.15	24.72	27.50	25.53
1000	19.60	19.68	20.36	26.17	26.59	23.74	25.59	23.76
1200	11.33	11.85	12.32	14.12	16.21	18.81	21.69	20.70
1400	7.65	8.25	8.82	9.90	11.86	15.10	18.82	18.43
1600	6.39	6.98	7.51	8.51	10.43	13.50	16.80	16.21
1800	6.70	7.31	7.92	8.82	10.51	13.30	15.41	14.66
2000	7.73	8.40	8.99	9.67	11.34	13.68	14.66	13.51
2200	9.54	10.19	10.62	11.22	12.43	14.00	13.78	12.40
2400	11.49	11.94	12.23	12.68	13.35	13.95	12.76	11.45

Typical Performance Data

TEST CONDITIONS: Vd1 = +3V, Vd2 = +5V @ Temperature = -40degC

FREQ	INPUT RETURN LOSS @							
	0 dB	0.5 dB	1 dB	2 dB	4 dB	8 dB	16 dB	31.5 dB
(MHz)	(dB)	(dB)	(dB)	(dB)	(dB)	(dB)	(dB)	(dB)
400	26.08	26.82	26.52	32.79	36.26	42.10	26.74	23.47
500	21.07	23.69	25.88	24.75	27.25	36.36	26.87	23.70
600	18.45	20.69	22.97	22.61	24.87	33.17	28.50	24.27
700	18.81	21.02	22.79	23.49	27.32	34.86	27.85	24.02
800	21.27	23.15	24.98	29.59	34.68	34.73	26.78	23.60
900	21.96	21.96	21.99	29.07	32.48	28.57	24.83	22.41
1000	17.38	17.47	17.46	20.82	22.91	24.17	23.72	21.62
1200	10.19	10.62	11.07	12.68	14.80	18.13	20.22	19.16
1400	6.84	7.50	8.05	9.34	11.41	15.10	17.98	17.22
1600	5.78	6.43	7.11	8.16	10.28	13.80	16.01	15.33
1800	6.13	6.90	7.62	8.64	10.66	13.60	14.61	13.68
2000	7.36	8.28	9.07	9.85	11.57	13.72	13.58	12.50
2200	9.39	10.34	10.86	11.58	12.72	13.62	12.40	11.39
2400	12.02	12.72	13.07	13.11	13.55	13.08	11.42	10.32

Digital Variable Gain Amplifier

DVGA1-242A+

Typical Performance Data

TEST CONDITIONS: Vd1 = +3V, Vd2 = +5V @ Temperature = +85degC

FREQ	INPUT RETURN LOSS @							
	0 dB	0.5 dB	1 dB	2 dB	4 dB	8 dB	16 dB	31.5 dB
(MHz)	(dB)	(dB)	(dB)	(dB)	(dB)	(dB)	(dB)	(dB)
400	15.28	16.34	17.18	16.78	17.47	18.45	22.85	25.87
500	13.25	14.23	15.27	14.80	15.84	17.46	21.85	24.34
600	13.09	14.07	14.99	14.83	15.90	17.57	21.37	23.35
700	14.10	15.27	16.43	16.06	16.95	18.04	21.14	22.56
800	16.71	18.17	19.50	18.96	18.73	18.63	20.88	21.78
900	20.98	22.99	25.08	25.58	21.99	19.37	20.50	20.78
1000	22.34	23.24	24.35	33.49	23.58	19.56	20.08	20.09
1200	12.43	12.98	13.34	15.15	16.64	17.39	18.91	18.63
1400	8.27	8.77	9.20	10.39	12.09	14.53	17.32	17.22
1600	6.84	7.35	7.80	8.73	10.35	12.95	15.97	15.82
1800	7.07	7.58	8.00	8.73	10.25	12.82	15.34	14.57
2000	7.98	8.52	8.84	9.62	10.94	13.23	14.86	13.78
2200	9.31	9.86	10.07	10.80	11.91	13.74	14.28	12.94
2400	11.04	11.37	11.47	12.13	13.12	14.26	13.79	12.37



Digital Variable Gain Amplifier

DVGA1-242A+

Typical Performance Data

TEST CONDITIONS: Vd1 = +3V, Vd2 = +5V @ Temperature = +25degC

FREQ	OUTPUT RETURN LOSS @							
	0 dB	0.5 dB	1 dB	2 dB	4 dB	8 dB	16 dB	31.5 dB
(MHz)	(dB)	(dB)	(dB)	(dB)	(dB)	(dB)	(dB)	(dB)
400	21.38	21.32	21.31	21.46	21.39	21.27	20.96	21.10
500	21.48	21.53	21.58	21.63	21.82	22.14	22.52	22.43
600	17.36	17.41	17.50	17.43	17.62	17.98	18.52	18.31
700	15.83	15.88	15.97	15.86	16.05	16.41	16.96	16.77
800	14.78	14.83	14.91	14.78	14.97	15.31	15.83	15.67
900	14.06	14.12	14.19	14.04	14.21	14.51	14.98	14.88
1000	13.58	13.59	13.66	13.51	13.64	13.86	14.27	14.25
1200	12.94	12.97	13.01	12.81	12.88	12.97	13.22	13.45
1400	12.89	12.89	12.82	12.62	12.54	12.38	12.32	12.74
1600	12.62	12.55	12.48	12.31	12.13	11.84	11.60	12.11
1800	11.56	11.50	11.37	11.33	11.15	10.81	10.51	10.99
2000	10.45	10.40	10.36	10.39	10.29	10.07	9.84	10.30
2200	9.99	9.98	9.95	10.03	10.00	9.86	9.70	10.06
2400	9.84	9.86	9.86	9.98	10.01	9.96	9.87	10.19

Digital Variable Gain Amplifier

DVGA1-242A+

Typical Performance Data

TEST CONDITIONS: Vd1 = +3V, Vd2 = +5V @ Temperature = -40degC

FREQ	OUTPUT RETURN LOSS @							
	0 dB	0.5 dB	1 dB	2 dB	4 dB	8 dB	16 dB	31.5 dB
(MHz)	(dB)	(dB)	(dB)	(dB)	(dB)	(dB)	(dB)	(dB)
400	19.67	19.55	19.53	19.67	19.63	19.52	19.25	19.37
500	21.01	21.00	21.03	21.14	21.28	21.52	21.64	21.69
600	16.61	16.59	16.64	16.55	16.70	16.95	17.35	17.20
700	14.94	14.96	15.01	14.86	14.99	15.26	15.73	15.55
800	13.75	13.75	13.81	13.64	13.75	14.02	14.49	14.32
900	12.80	12.79	12.84	12.66	12.73	12.95	13.40	13.26
1000	11.92	11.93	11.98	11.79	11.82	12.02	12.45	12.36
1200	11.05	10.98	10.99	10.80	10.86	10.86	11.15	11.25
1400	11.06	11.00	10.96	10.74	10.59	10.53	10.55	10.80
1600	11.08	10.98	10.93	10.68	10.53	10.31	10.15	10.51
1800	10.39	10.25	10.27	10.14	9.99	9.74	9.51	9.88
2000	9.76	9.68	9.64	9.63	9.62	9.44	9.27	9.63
2200	9.61	9.56	9.52	9.51	9.57	9.46	9.31	9.59
2400	9.16	9.25	9.21	9.27	9.37	9.35	9.28	9.54

Digital Variable Gain Amplifier

DVGA1-242A+

Typical Performance Data

TEST CONDITIONS: Vd1 = +3V, Vd2 = +5V @ Temperature = +85degC

FREQ	OUTPUT RETURN LOSS @							
	0 dB	0.5 dB	1 dB	2 dB	4 dB	8 dB	16 dB	31.5 dB
(MHz)	(dB)	(dB)	(dB)	(dB)	(dB)	(dB)	(dB)	(dB)
400	24.62	24.56	24.51	24.65	24.55	24.37	24.04	24.18
500	22.57	22.63	22.74	22.70	22.99	23.50	24.17	23.98
600	18.37	18.45	18.55	18.48	18.73	19.15	19.79	19.58
700	16.84	16.93	17.02	16.94	17.17	17.55	18.12	17.96
800	15.89	15.97	16.06	15.96	16.18	16.52	17.01	16.93
900	15.34	15.42	15.49	15.41	15.60	15.88	16.27	16.30
1000	15.22	15.27	15.34	15.24	15.38	15.57	15.87	15.98
1200	14.93	14.97	14.99	14.90	14.96	15.00	15.11	15.58
1400	14.68	14.67	14.63	14.53	14.45	14.26	14.13	14.79
1600	14.05	13.99	13.90	13.80	13.63	13.31	13.02	13.73
1800	12.51	12.45	12.34	12.32	12.14	11.79	11.46	12.08
2000	11.34	11.27	11.20	11.27	11.15	10.88	10.60	11.15
2200	10.69	10.67	10.64	10.74	10.70	10.55	10.36	10.82
2400	10.72	10.71	10.71	10.84	10.84	10.76	10.62	10.97



Typical Performance Curves

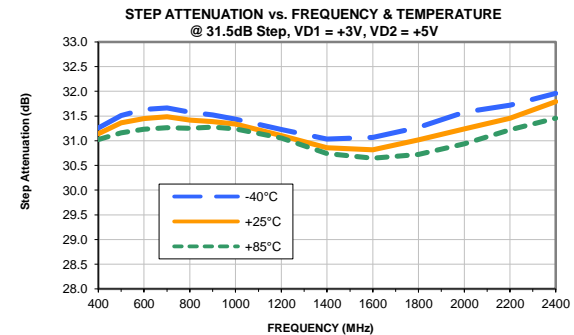
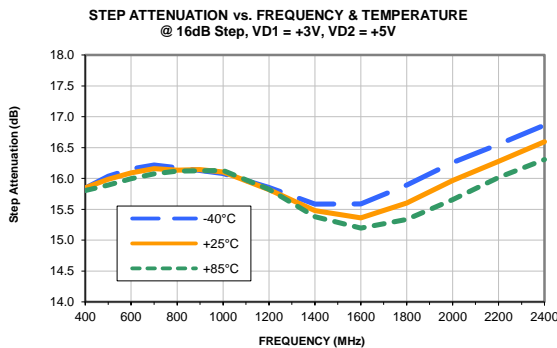
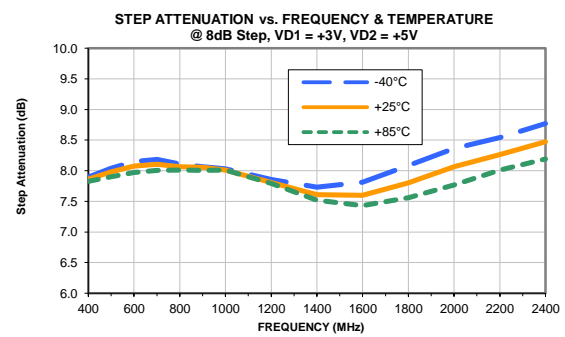
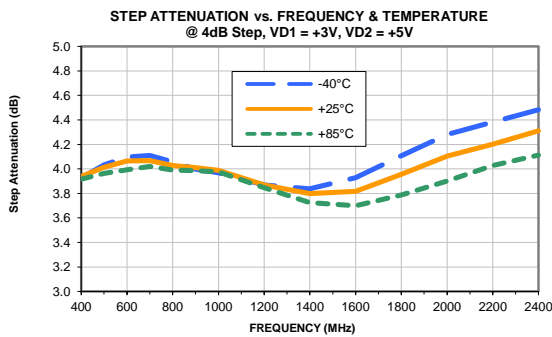
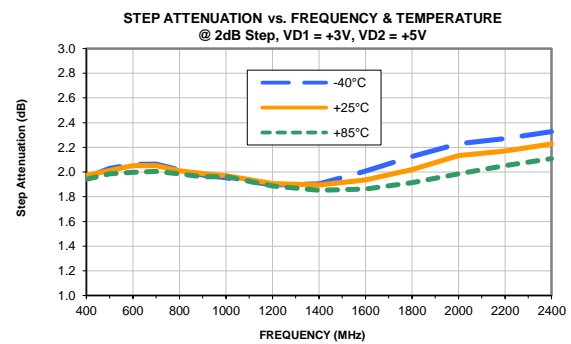
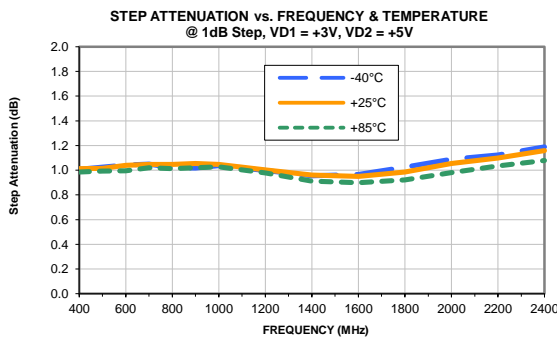
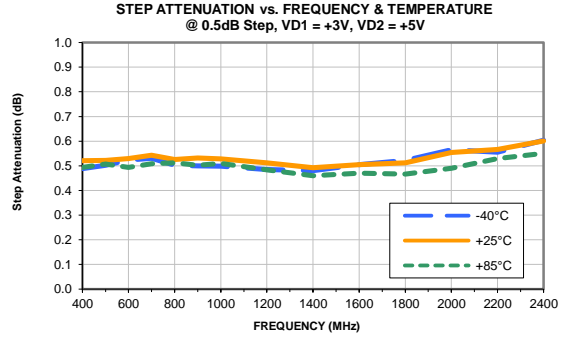
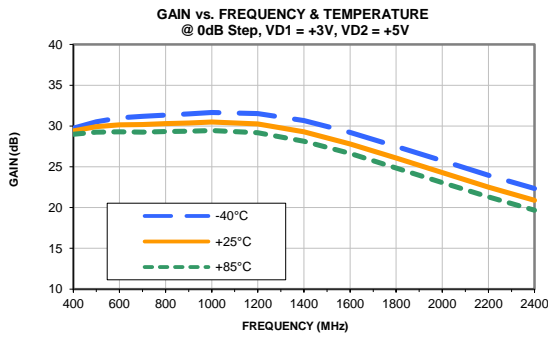

Digital Variable Gain Amplifier

DVGA1-242A+

Typical Performance Curves

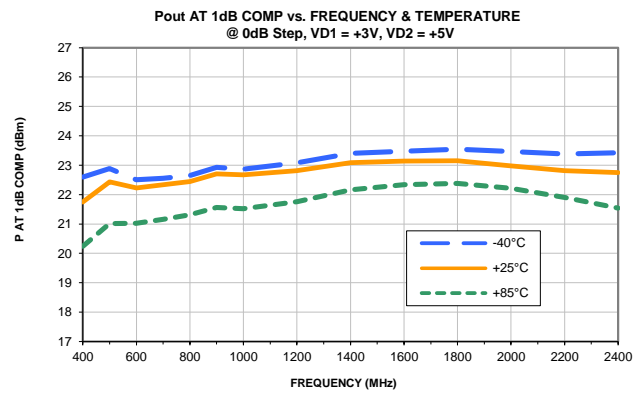
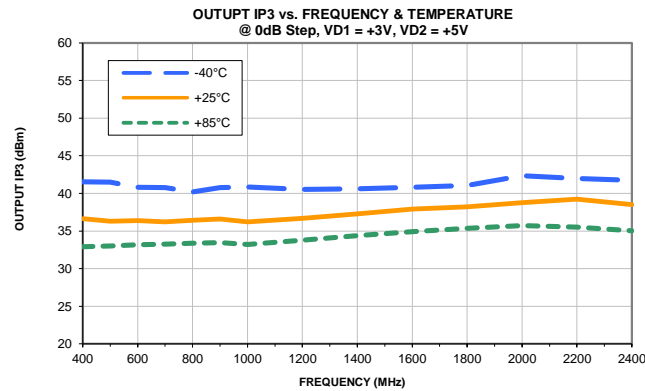
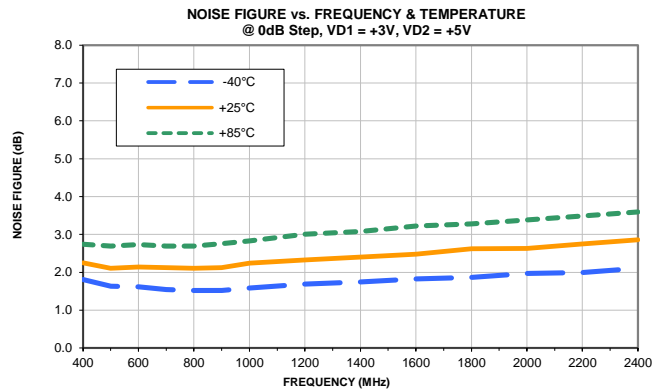

Typical Performance Curves

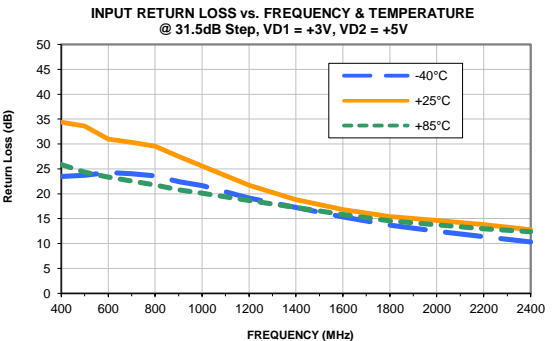
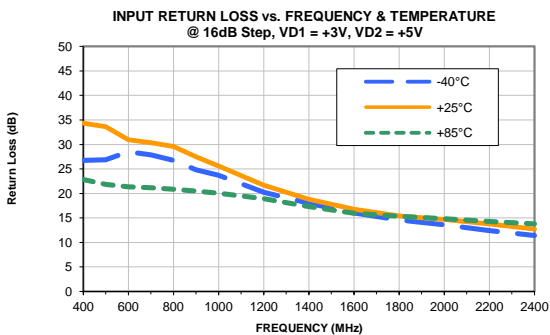
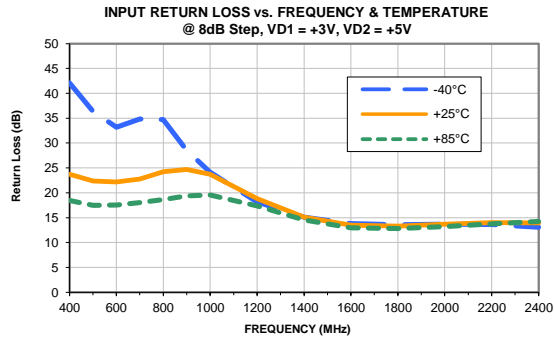
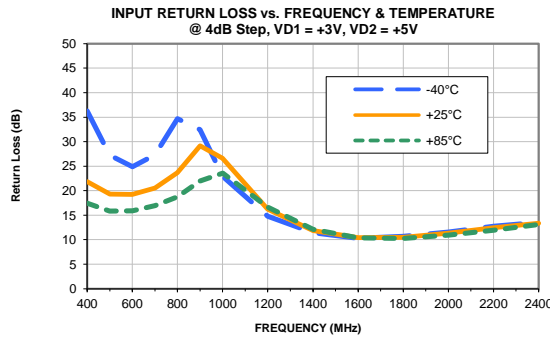
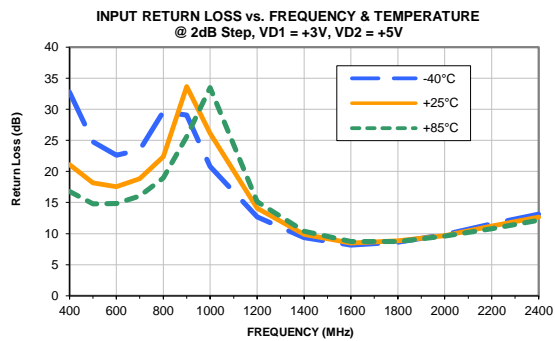
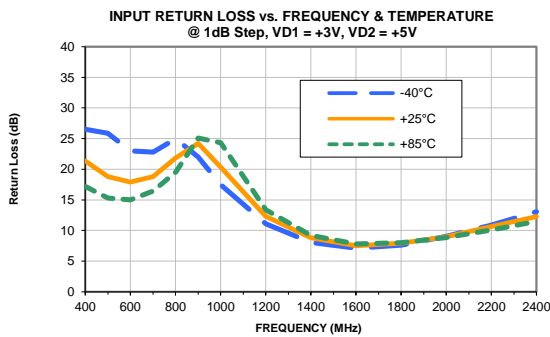
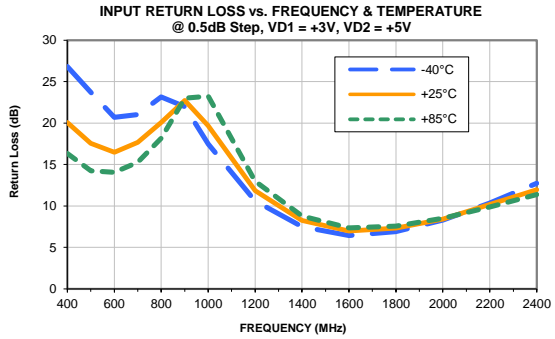
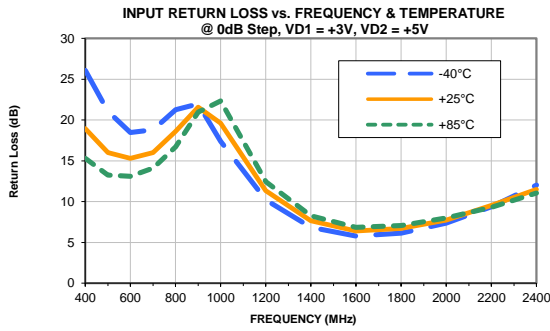

Typical Performance Curves

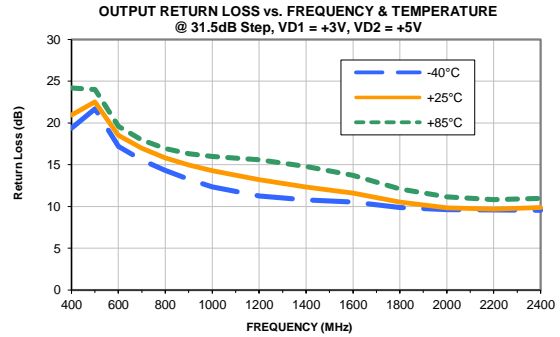
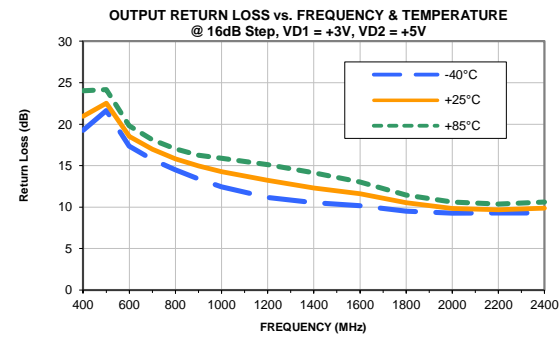
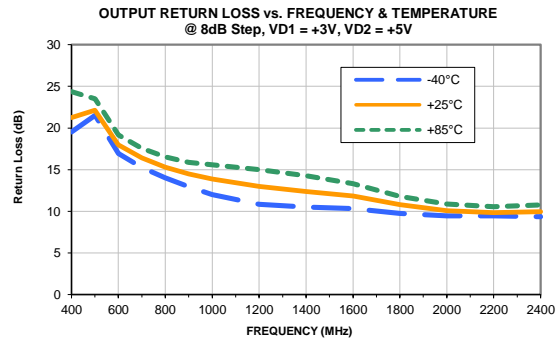
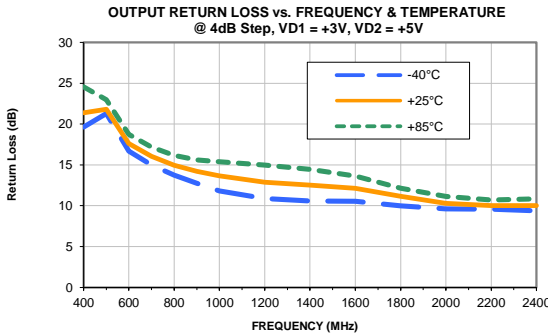
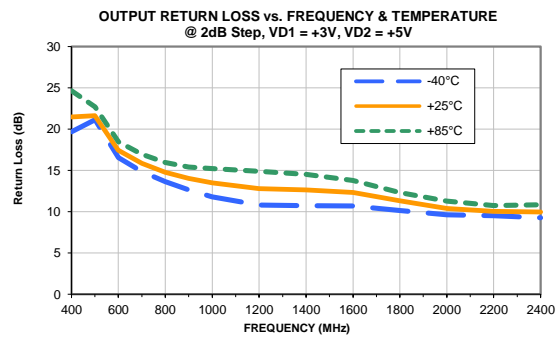
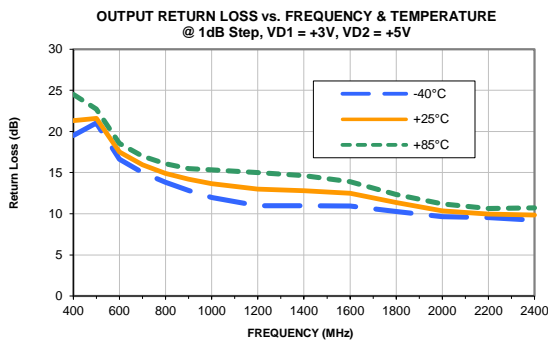
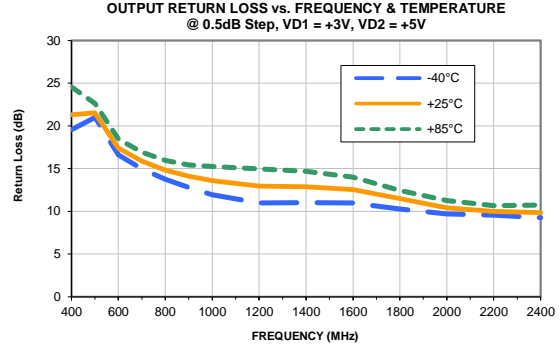
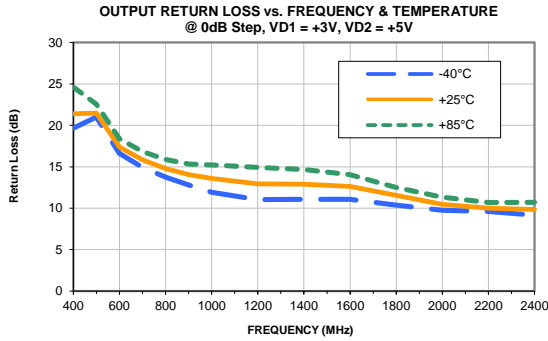

Outline Dimensions

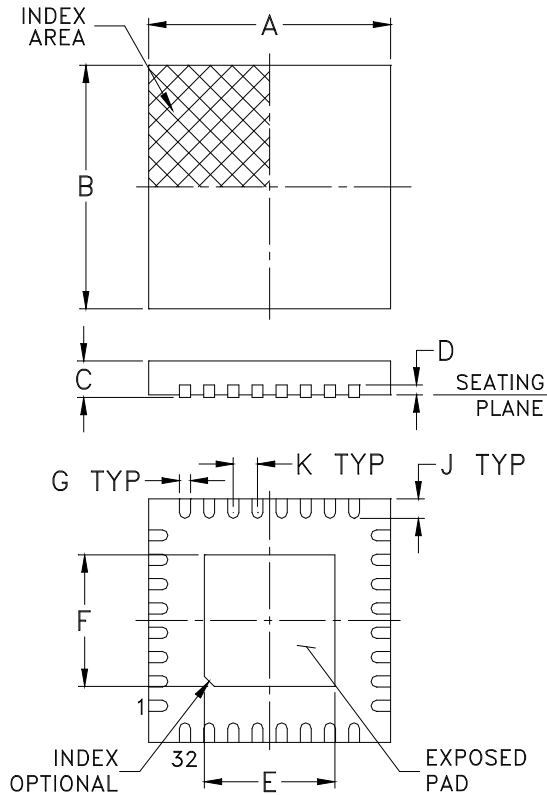

PCB Land Pattern

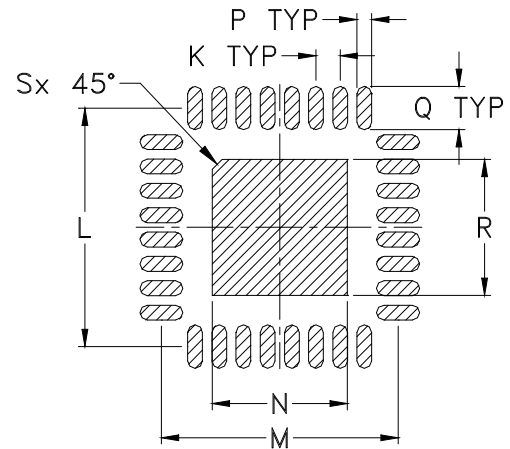

Suggested Layout,
Tolerance to be within ± 0.002

CASE #	A	B	C MAX	C MIN	D	E	F	G	H	J
DG1677	.197 (5.00)	.197 (5.00)	.039 (1.00)	.031 (0.80)	.008 (0.20)	.106 (2.70)	.106 (2.70)	.009 (0.23)	-	.016 (0.40)

CASE #	K	L	M	N	P	Q	R	S	WT. GRAM
DG1677	.020 (0.50)	.193 (4.90)	.193 (4.90)	.110 (2.79)	.012 (0.30)	.035 (0.89)	.110 (2.79)	.008 (0.20)	.05

Dimensions are in inches (mm). Tolerances: 2 Pl. $\pm .01$; 3 Pl. $\pm .005$

Notes:

1. Case material: Plastic.
2. Termination finish:

For RoHS Case Styles: Pre-plated (Ni Pd Au), transitioning to Matt-Tin. All models, (+) suffix.
For RoHS-5 Case Styles: Tin-Lead plate. All models, no (+) suffix.

Tape & Reel Packaging TR-F68

DEVICE ORIENTATION IN T&R

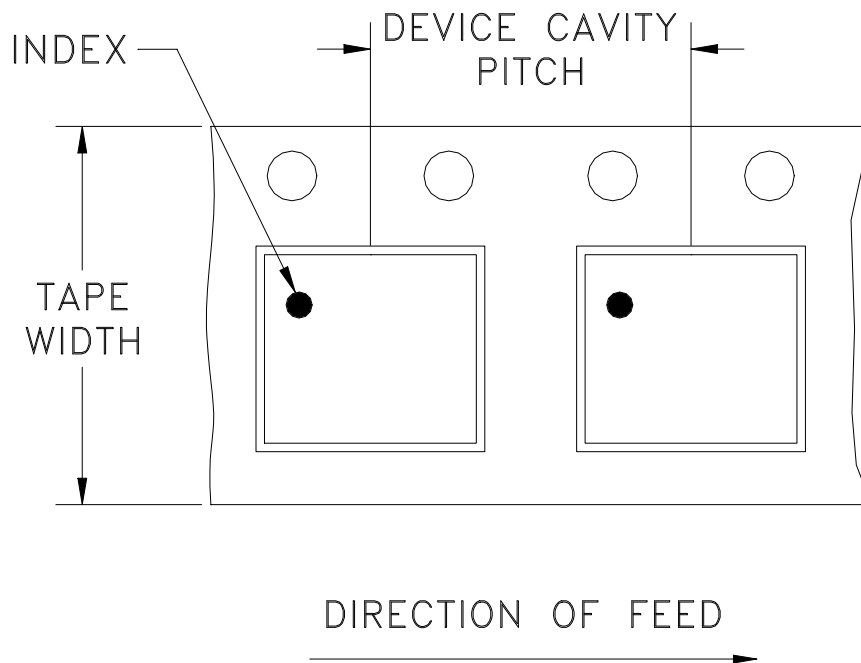

Tape Width, mm	Device Cavity Pitch, mm	Reel Size, inches	Devices per Reel see note	
12	8	7	Small quantity standard	20
				50
				100
				200
				500
		7	Standard	1000
		13	Standard	2000
				3000
4000				

Mini-Circuits carrier tape materials provide protection from ESD (Electro-Static Discharge) during handling and transportation. Tapes are static dissipative and comply with industry standards EIA-481/EIA-541.

Go to: www.minicircuits.com/pages/pdfs/tape.pdf



INTERNET <http://www.minicircuits.com>

P.O. Box 350166, Brooklyn, New York 11235-0003 (718) 934-4500 Fax (718) 332-4661

Distribution Centers NORTH AMERICA 800-654-7949 • 417-335-5935 • Fax 417-335-5945 • EUROPE 44-1252-832600 • Fax 44-1252-837010

Mini-Circuits ISO 9001 & ISO 14001 Certified

THIRD ANGLE PROJECTION

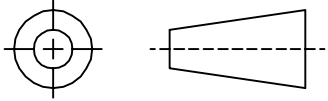

REVISIONS

REV	ECN No.	DESCRIPTION	DATE	DR	AUTH
OR	M133785	NEW RELEASE	10/05/11	AV	SL

SUGGESTED MOUNTING CONFIGURATION
FOR DG1677 CASE STYLE, "32AM01" PIN CODE

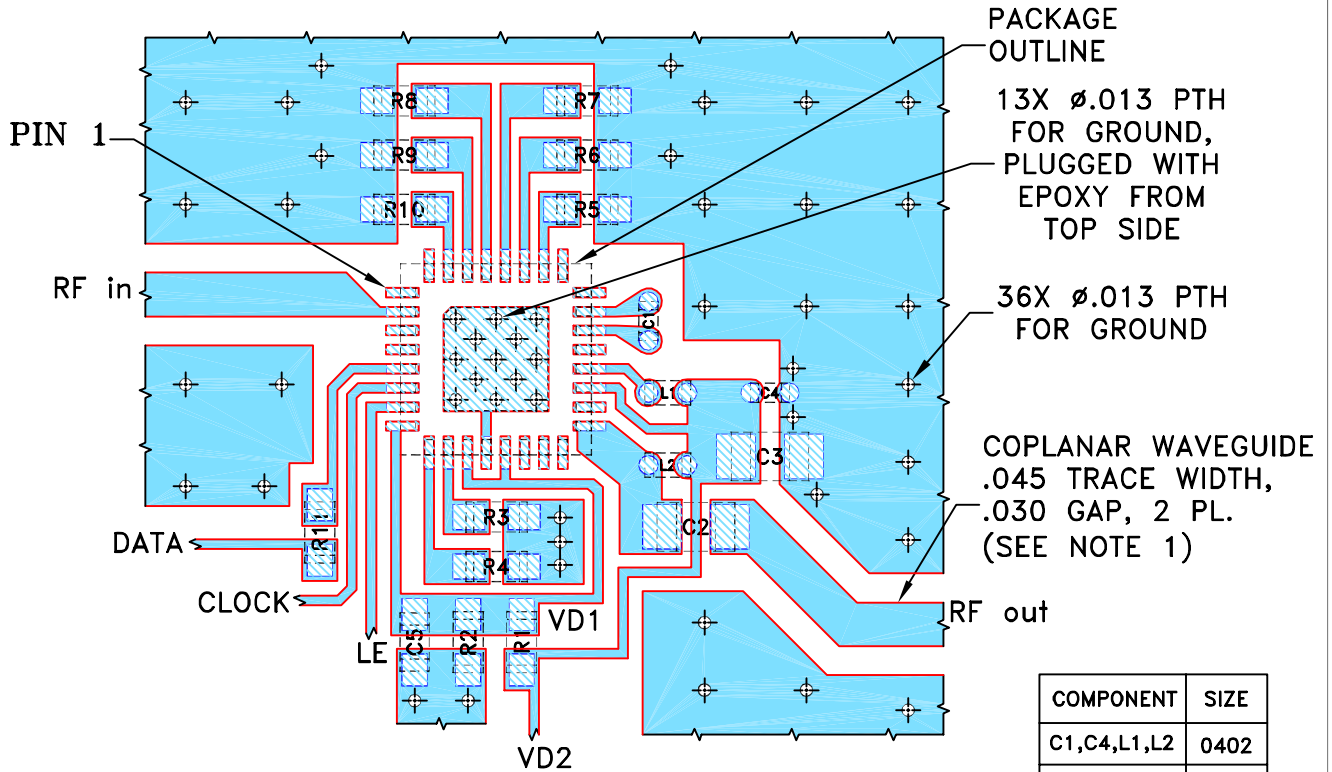

COMPONENT	SIZE
C1,C4,L1,L2	0402
R1-R11,C5	0603
C2,C3	0805

NOTES:

1. COPLANAR WAVEGUIDE PARAMETERS ARE SHOWN FOR IT-180TC WITH DIELECTRIC THICKNESS .024" ± .002". COPPER: 1/2 OZ. EACH SIDE. FOR OTHER MATERIALS TRACE WIDTH AND GAP MAY NEED TO BE MODIFIED.
2. CHIP COMPONENT FOOT PRINTS SHOWN FOR REFERENCE. FOR COMPONENT VALUES REFER TO TB-643+.
3. BOTTOM SIDE OF THE PCB IS CONTINUOUS GROUND PLANE.

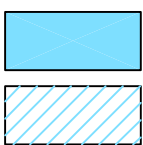

SOLID BLUE DENOTES PCB COPPER LAYOUT WITH SMOBC (SOLDER MASK OVER BARE COPPER).
HATCHED BLUE DENOTES COPPER LAND PATTERN FREE OF SOLDER MASK.

UNLESS OTHERWISE SPECIFIED	INITIALS	DATE
DRAWN	AV	09/28/11
CHECKED	PW	10/05/11
APPROVED	SL	10/05/11

Mini-Circuits® 13 Neptune Avenue
Brooklyn NY 11235

PL, 32AM01, DG1677, TB-643+

Mini-Circuits®
THIS DOCUMENT AND ITS CONTENTS ARE THE PROPERTY OF MINI-CIRCUITS. EXCEPT FOR USE EXPRESSLY GRANTED, IN WRITING, TO ITS VENDORS, VENDEE AND THE UNITED STATES GOVERNMENT, MINI-CIRCUITS RESERVES ALL PROPRIETARY DESIGN, USE, MANUFACTURING AND REPRODUCTION RIGHTS THERETO. THESE CONTENTS SHALL NOT BE USED, DUPLICATED OR DISCLOSED TO ANY OUTSIDE PARTY, IN WHOLE OR IN PART, WITHOUT WRITTEN PERMISSION OF MINI-CIRCUITS.

SIZE	CODE IDENT	DRAWING NO:	REV:
A	15542	98-PL-355	OR
FILE:	98PL355	SCALE: 5:1	SHEET: 1 OF 1

Evaluation Board and Circuit

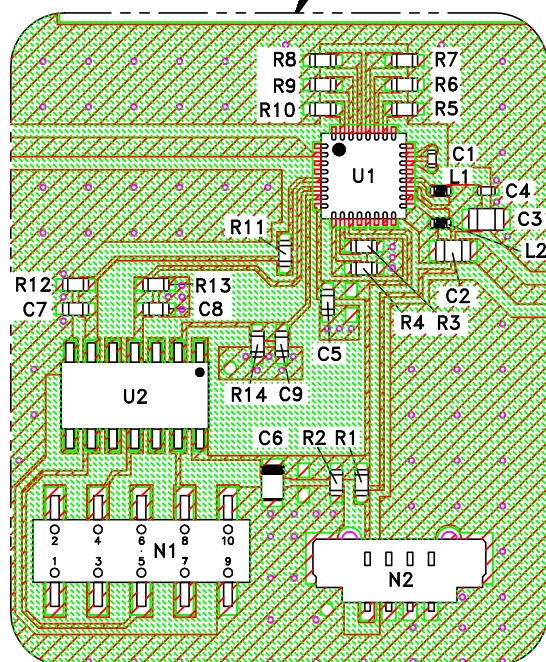
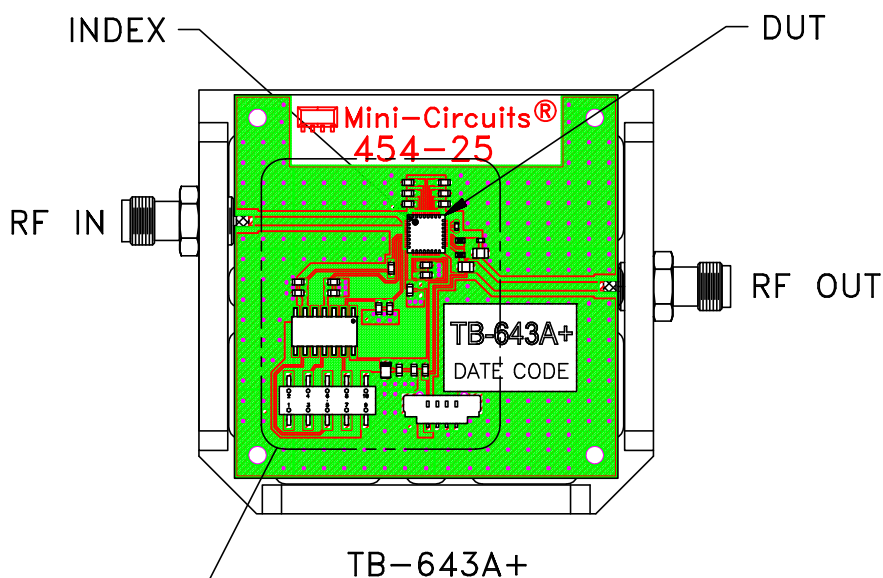

COMPONENT	VALUE/ PART NUMBER	SIZE
U1	DVGA1-242A+	-
U2	Hex Inverting Schmitt Trigger	-
C1, C4	100 pF	.04 X .02
C2	100 pF	.08 X .05
C3	1 uF	.08 X .05
C5, C7-C9	100 pF	.06 X .03
C6	.47 uF	.08 X .05
L1	36 nH	.04 X .02
L2	47 nH	.04 X .02
R1	475 Ohm	.06 X .03
R2	681 Ohm	.06 X .03
R3-R14	10 KOhm	.06 X .03
TEST CABLE 1	B66-23+	-
TEST CABLE 2	B66-25+	-

Notes:

1. Test cables for "N1" and "N2" are included in TB-643+.
2. The test software is available at:
Mini-Circuits website: http://www.minicircuits.com/support/software_download.html
Software name: "Digital Step Attenuator & DVGA".
3. 50 Ohm SMA Female connectors.
4. PCB Material: FR4 or equivalent,
Dielectric Constant=4.6, Thickness=.024 inch.

 **Mini-Circuits®**

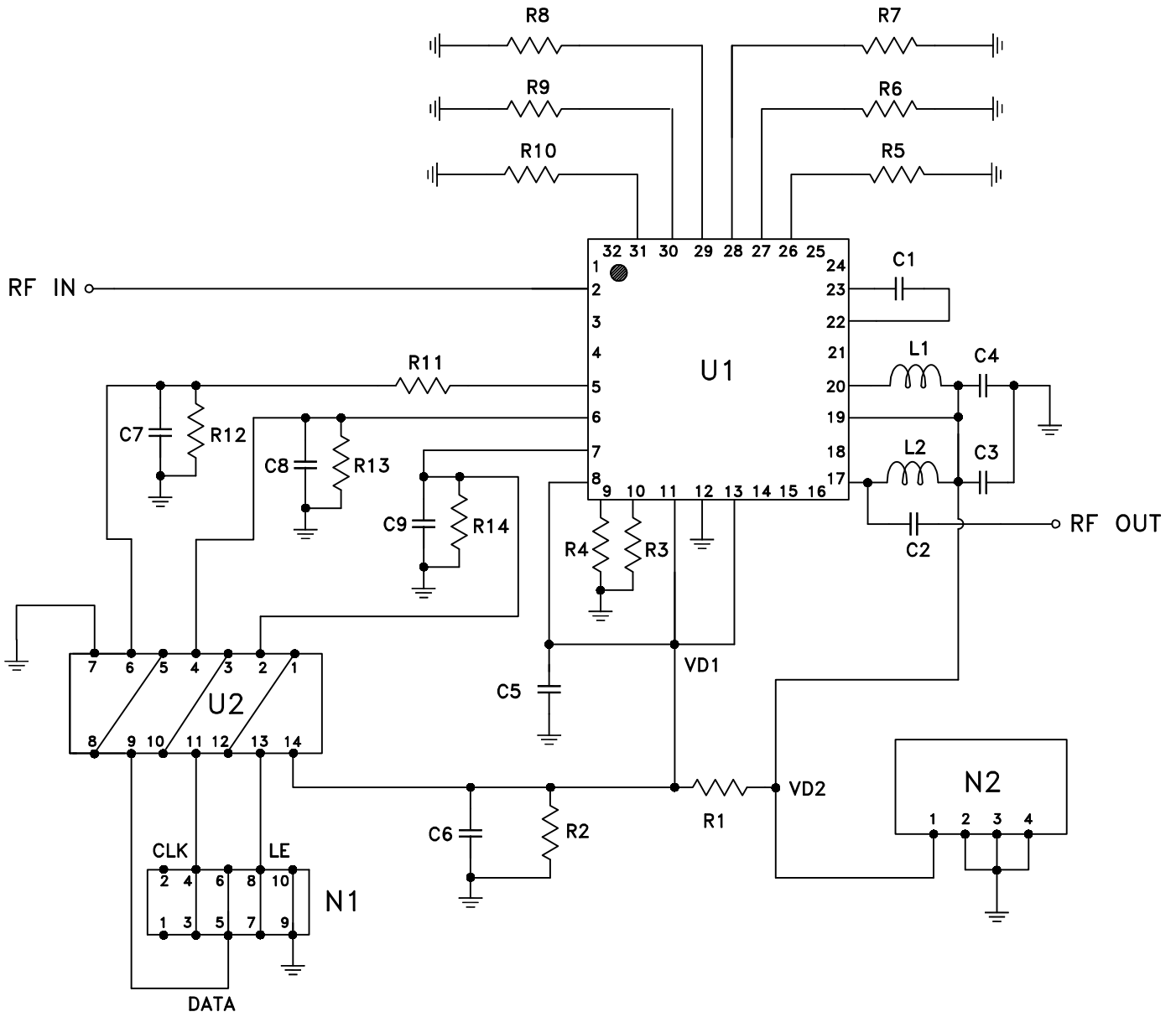

Schematic Diagram

All Mini-Circuits products are manufactured under exacting quality assurance and control standards, and are capable of meeting published specifications after being subjected to any or all of the following physical and environmental test.

Specification	Test/Inspection Condition	Reference/Spec
Operating Temperature	-40° to 85°C	Individual Model Data Sheet
Storage Temperature	-55° to 100° C or -65° to 150°	Individual Model Data Sheet
Thermal Shock	-65° to 150°C, 1000 Cycles	JESD22-A104D, condition C
Autoclave	15 psig, 100% RH, 121°C, 168 hours	JESD22-A102D, Condition C
Solderability	10X Magnification	J-STD-002, Para 4.2.5, Test S, 95% Coverage
Moisture Sensitivity: Level 1	Bake at 125°C for 24 hours. Soak at 85°C/85%RH for 168 hours Reflow 3 cycles at 260°C peak	J-STD-020D.01