

Power Splitter/Combiner

SCP-5-1+

5 Way-0° 50Ω

2 to 200 MHz



Generic photo used for illustration purposes only
CASE STYLE: YY161

+RoHS Compliant

The +Suffix identifies RoHS Compliance. See our web site for RoHS Compliance methodologies and qualifications

Maximum Ratings

Operating Temperature	-40°C to 85°C
Storage Temperature	-55°C to 100°C
Power Input (as a splitter)	1W max.
Internal Dissipation	0.625W max.

Permanent damage may occur if any of these limits are exceeded.

Pin Connections

SUM PORT	1
PORT 1	6
PORT 2	8
PORT 3	7
PORT 4	5
PORT 5	3
GROUND	2,4

Outline Drawing

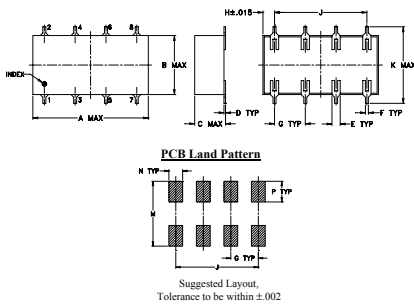

Outline Dimensions (inch)

A	B	C	D	E	F	G
0.75	0.38	0.28	0.01	0.05	0.02	0.2
19.05	9.65	7.11	0.25	1.27	0.51	5.08
H	J	K	M	N	P	wt
0.075	0.6	0.45	0.47	0.1	0.15	grams
1.91	15.24	11.43	11.94	2.54	3.81	1.60

Demo Board MCL P/N: TB-213 Suggested PCB Layout (PL-104)

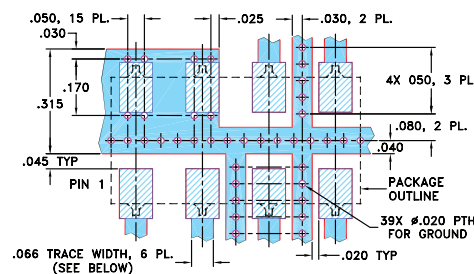

Features

- low insertion loss, 0.3 dB typ.
- high isolation 29 dB typ.
- excellent amplitude unbalance, 0.3 dB typ.

Applications

- VHF
- instrumentation
- receivers/transmitters

Electrical Specifications

FREQ. RANGE (MHz)	ISOLATION (dB)			INSERTION LOSS (dB) ABOVE 7.0 dB			PHASE UNBALANCE (Degrees)			AMPLITUDE UNBALANCE (dB)								
	L	M	U	L	M	U	L	M	U	L	M	U						
f_L - f_U	Typ. Min.	Typ. Min.	Typ. Min.	Typ. Max.	Typ. Max.	Typ. Max.	Max.	Max.	Max.	Max.	Max.	Max.						
2-200	30	20	29	20	30	20	0.2	0.5	0.3	0.75	0.6	1.5	1	3	5	0.2	0.3	0.6

L = low range [f_L to $10 f_L$] M = mid range [$10 f_L$ to $f_U/2$] U = upper range [$f_U/2$ to f_U]

Typical Performance Data

Freq. (MHz)	Total Loss ¹ (dB)					Amp. Unbal. (dB)	Isolation (dB)				Phase Unbal. (deg.)	VSWR S	VSWR OUTPUTS
	S-1	S-2	S-3	S-4	S-5		1-2	2-3	2-4	3-5			
2.00	7.18	7.17	7.17	7.17	7.17	0.01	47.70	45.82	27.74	27.47	0.04	1.10	1.18
6.00	7.17	7.15	7.16	7.16	7.16	0.02	45.13	44.43	30.00	29.83	0.09	1.09	1.12
12.00	7.18	7.17	7.18	7.17	7.18	0.01	43.80	43.17	30.31	30.22	0.19	1.08	1.10
18.00	7.20	7.19	7.19	7.19	7.19	0.01	42.81	42.17	30.23	30.17	0.27	1.08	1.10
30.00	7.22	7.21	7.21	7.21	7.22	0.01	41.21	40.49	29.90	29.95	0.46	1.07	1.10
45.00	7.26	7.24	7.23	7.24	7.25	0.02	39.48	38.73	29.59	29.68	0.60	1.06	1.10
60.00	7.28	7.26	7.26	7.26	7.27	0.02	38.25	37.46	29.48	29.63	0.88	1.06	1.11
75.00	7.31	7.29	7.28	7.30	7.31	0.03	37.24	36.46	29.46	29.68	1.03	1.06	1.11
90.00	7.34	7.31	7.31	7.32	7.35	0.04	36.45	35.56	29.57	29.88	1.23	1.06	1.11
105.00	7.36	7.33	7.33	7.34	7.38	0.05	35.72	34.77	29.72	30.22	1.45	1.07	1.11
120.00	7.40	7.36	7.37	7.37	7.42	0.05	34.94	33.93	30.03	30.72	1.58	1.09	1.11
135.00	7.44	7.40	7.40	7.41	7.47	0.07	34.07	32.98	30.42	31.40	1.76	1.12	1.12
160.00	7.52	7.47	7.46	7.48	7.57	0.11	32.14	31.04	31.11	32.92	2.04	1.19	1.12
180.00	7.62	7.55	7.55	7.58	7.68	0.13	30.17	29.10	31.10	33.81	2.35	1.28	1.13
200.00	7.76	7.67	7.67	7.70	7.83	0.16	27.91	26.91	29.96	32.90	2.63	1.40	1.14

1. Total Loss = Insertion Loss + 7dB splitter loss.

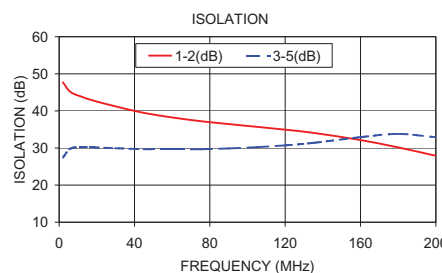
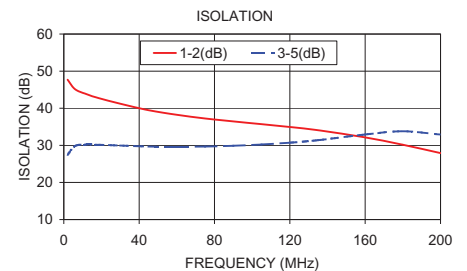
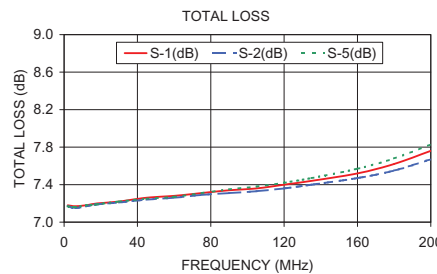

electrical schematic



Notes

- Performance and quality attributes and conditions not expressly stated in this specification document are intended to be excluded and do not form a part of this specification document.
- Electrical specifications and performance data contained in this specification document are based on Mini-Circuit's applicable established test performance criteria and measurement instructions.
- The parts covered by this specification document are subject to Mini-Circuit's standard limited warranty and terms and conditions (collectively, "Standard Terms"); Purchasers of this part are entitled to the rights and benefits contained therein. For a full statement of the Standard Terms and the exclusive rights and remedies thereunder, please visit Mini-Circuit's website at www.minicircuits.com/MCLStore/terms.jsp



5 Way-0° Power Splitter/Combiner

SCP-5-1+

Typical Performance Data

TEST CONDITIONS: INPUT POWER = 0dBm @Temperature = -40°C

FREQ. (MHz)	TOTAL LOSS ¹ (dB)					AMP. UNBAL (dB)	PHASE UNBAL (deg.)	ISOLATION (dB)					VSWR (:1)					
	S-1	S-2	S-3	S-4	S-5			1-2	1-3	2-3	3-5	4-5	S	1	2	3	4	5
	1	7.37	7.37	7.37	7.36			7.37	0.01	0.24	52.65	21.16	44.12	20.91	50.79	1.22	1.57	1.57
2	7.31	7.30	7.30	7.30	7.30	0.01	0.21	52.22	23.11	45.69	22.96	49.36	1.17	1.40	1.40	1.40	1.40	1.40
3	7.26	7.26	7.26	7.26	7.25	0.01	0.20	50.60	24.44	45.66	24.36	47.75	1.14	1.32	1.32	1.32	1.32	1.31
4	7.23	7.23	7.23	7.23	7.22	0.01	0.18	48.73	25.44	45.06	25.42	46.43	1.13	1.27	1.27	1.27	1.27	1.26
5	7.21	7.20	7.20	7.21	7.20	0.01	0.15	47.16	26.30	44.45	26.32	45.48	1.12	1.23	1.24	1.24	1.23	1.23
10	7.15	7.15	7.16	7.16	7.16	0.01	0.23	43.63	29.07	42.50	29.08	42.87	1.10	1.14	1.15	1.15	1.14	1.14
15	7.15	7.14	7.15	7.16	7.15	0.01	0.28	42.15	30.21	41.68	30.19	41.86	1.09	1.11	1.11	1.11	1.11	1.11
20	7.15	7.15	7.15	7.16	7.15	0.01	0.30	41.26	30.58	40.88	30.53	41.09	1.09	1.10	1.10	1.10	1.10	1.10
25	7.16	7.15	7.16	7.17	7.16	0.01	0.44	40.49	30.66	40.13	30.62	40.46	1.08	1.09	1.09	1.09	1.09	1.09
30	7.16	7.16	7.16	7.17	7.17	0.02	0.52	39.83	30.66	39.46	30.62	39.94	1.08	1.09	1.08	1.08	1.09	1.08
35	7.17	7.16	7.17	7.18	7.18	0.01	0.62	39.28	30.63	38.81	30.62	39.41	1.09	1.08	1.08	1.08	1.08	1.08
40	7.18	7.17	7.18	7.18	7.19	0.02	0.68	38.71	30.61	38.24	30.60	38.95	1.09	1.08	1.08	1.08	1.08	1.08
45	7.19	7.18	7.18	7.20	7.20	0.01	0.74	38.20	30.54	37.67	30.55	38.49	1.09	1.08	1.07	1.07	1.08	1.07
50	7.20	7.19	7.19	7.20	7.21	0.02	0.87	37.70	30.50	37.22	30.52	38.16	1.09	1.08	1.07	1.07	1.07	1.07
60	7.21	7.20	7.21	7.22	7.23	0.03	1.01	36.92	30.38	36.32	30.45	37.43	1.09	1.07	1.07	1.07	1.07	1.07
70	7.23	7.22	7.22	7.23	7.25	0.04	1.18	36.24	30.28	35.59	30.41	36.88	1.10	1.07	1.07	1.07	1.07	1.07
80	7.25	7.23	7.23	7.24	7.27	0.04	1.33	35.67	30.20	34.95	30.39	36.37	1.10	1.07	1.07	1.07	1.07	1.07
90	7.26	7.25	7.25	7.26	7.29	0.05	1.49	35.22	30.16	34.40	30.43	35.98	1.11	1.07	1.07	1.07	1.07	1.07
100	7.28	7.26	7.26	7.28	7.32	0.06	1.71	34.83	30.18	33.94	30.54	35.66	1.11	1.07	1.07	1.07	1.07	1.08
110	7.30	7.27	7.28	7.30	7.34	0.07	1.84	34.54	30.24	33.54	30.68	35.40	1.11	1.07	1.07	1.08	1.08	1.08
120	7.32	7.29	7.29	7.30	7.36	0.08	2.03	34.29	30.42	33.23	30.97	35.22	1.12	1.07	1.08	1.08	1.08	1.08
130	7.34	7.30	7.30	7.32	7.39	0.09	2.21	34.10	30.68	32.89	31.34	35.01	1.12	1.07	1.08	1.08	1.08	1.09
140	7.36	7.31	7.32	7.34	7.42	0.11	2.38	33.87	31.02	32.52	31.84	34.71	1.13	1.08	1.08	1.08	1.08	1.09
150	7.39	7.34	7.34	7.36	7.46	0.12	2.52	33.54	31.45	32.07	32.46	34.29	1.15	1.08	1.09	1.09	1.09	1.10
160	7.42	7.36	7.36	7.39	7.50	0.14	2.73	33.06	31.97	31.52	33.19	33.67	1.17	1.09	1.09	1.09	1.09	1.10
170	7.45	7.38	7.38	7.41	7.54	0.16	2.91	32.36	32.54	30.77	34.02	32.78	1.20	1.09	1.09	1.10	1.10	1.11
180	7.50	7.42	7.43	7.45	7.60	0.17	3.07	31.44	32.98	29.87	34.67	31.66	1.24	1.10	1.10	1.10	1.10	1.12
190	7.55	7.47	7.47	7.51	7.66	0.19	3.27	30.32	33.09	28.79	34.80	30.35	1.29	1.11	1.11	1.11	1.11	1.12
200	7.62	7.53	7.54	7.57	7.74	0.22	3.47	29.04	32.60	27.59	33.97	28.92	1.36	1.12	1.12	1.12	1.12	1.14
210	7.71	7.61	7.61	7.65	7.84	0.23	3.62	27.67	31.45	26.33	32.39	27.48	1.44	1.13	1.13	1.14	1.14	1.15
220	7.82	7.72	7.72	7.76	7.97	0.26	3.83	26.30	29.88	25.04	30.42	26.05	1.54	1.14	1.15	1.15	1.15	1.16
230	7.97	7.85	7.85	7.90	8.13	0.28	4.06	24.94	28.14	23.77	28.43	24.67	1.66	1.15	1.16	1.17	1.16	1.18
240	8.14	8.02	8.02	8.07	8.32	0.30	4.26	23.65	26.43	22.54	26.56	23.36	1.80	1.16	1.18	1.18	1.18	1.19
250	8.36	8.22	8.22	8.28	8.55	0.33	4.42	22.44	24.82	21.39	24.87	22.14	1.98	1.17	1.19	1.20	1.19	1.20
260	8.63	8.48	8.48	8.54	8.84	0.35	4.65	21.31	23.36	20.31	23.36	21.02	2.18	1.18	1.20	1.22	1.20	1.21
270	8.95	8.78	8.79	8.85	9.17	0.39	4.86	20.29	22.04	19.32	22.02	20.00	2.43	1.19	1.21	1.23	1.21	1.22
280	9.32	9.15	9.15	9.22	9.56	0.41	5.13	19.36	20.87	18.43	20.83	19.08	2.71	1.19	1.22	1.24	1.22	1.23
290	9.76	9.57	9.57	9.64	10.00	0.43	5.30	18.53	19.83	17.62	19.79	18.26	3.04	1.20	1.24	1.26	1.23	1.24
300	10.26	10.05	10.06	10.13	10.52	0.47	5.57	17.80	18.92	16.91	18.87	17.53	3.41	1.20	1.25	1.27	1.24	1.24
325	11.76	11.53	11.53	11.62	12.06	0.53	6.19	16.38	17.15	15.51	17.11	16.11	4.55	1.20	1.27	1.30	1.26	1.25
350	13.58	13.32	13.32	13.42	13.91	0.60	6.88	15.41	15.94	14.56	15.91	15.16	5.88	1.19	1.28	1.32	1.26	1.25

¹ Total Loss = Insertion Loss+ 7dB Splitter Loss



5 Way-0° Power Splitter/Combiner

SCP-5-1+

Typical Performance Curves

Total Loss

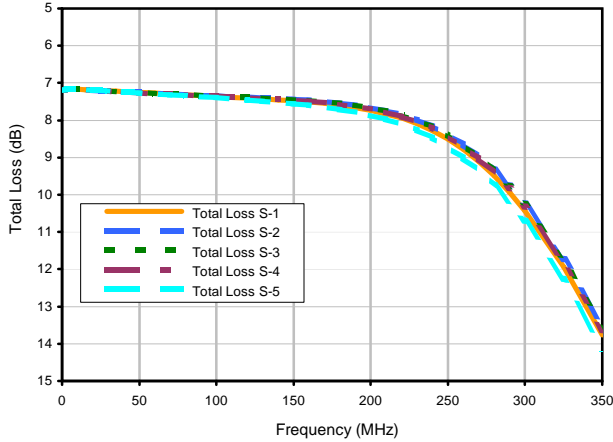

Total Loss S-1 vs. TEMPERATURE

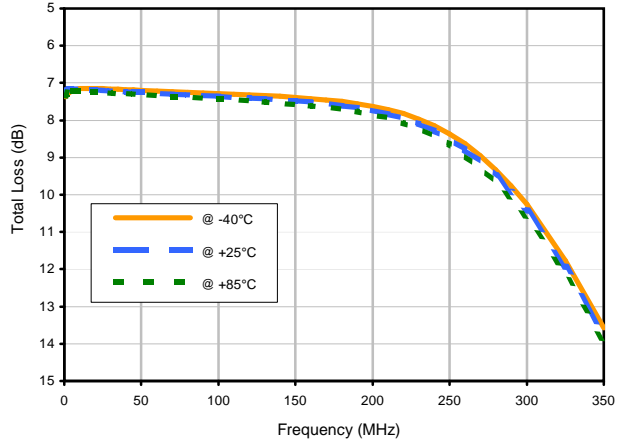

Amplitude Unbalance vs. TEMPERATURE

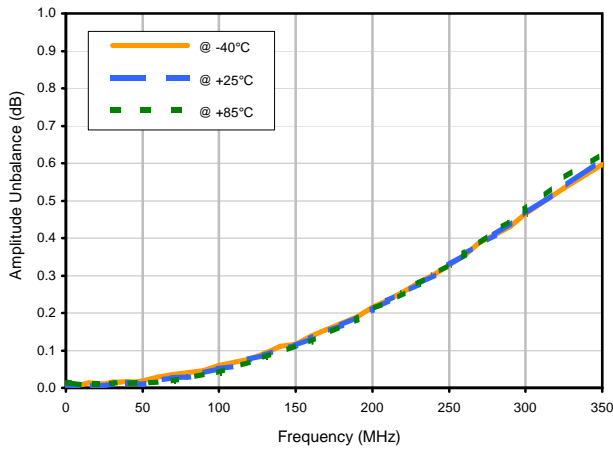

Phase Unbalance vs. TEMPERATURE

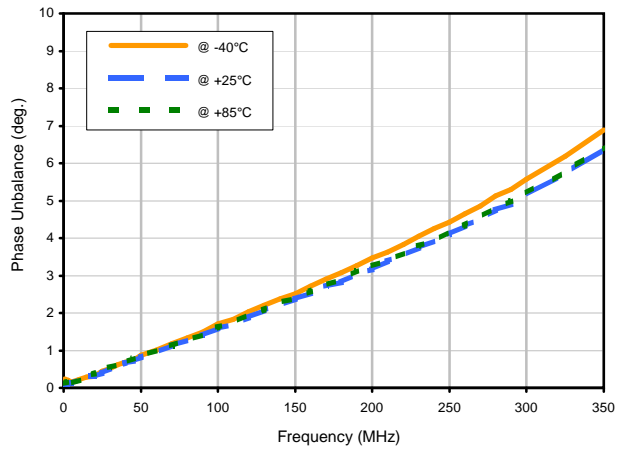

Isolation

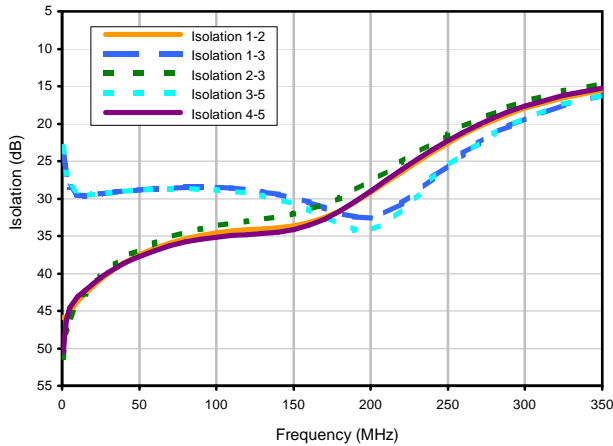

Isolation 1-2 vs. TEMPERATURE

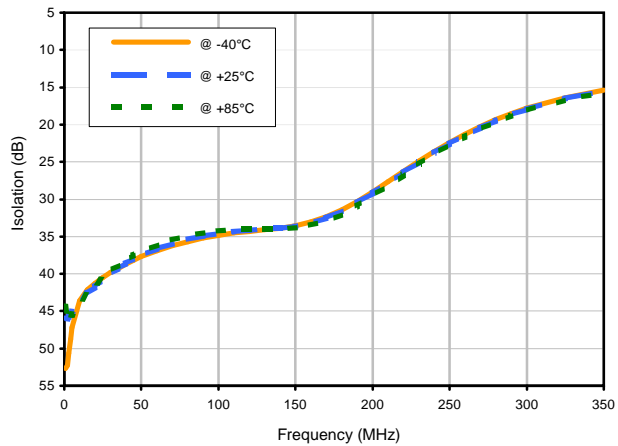

REV. X2
SCP-5-1+
100627
Page 1 of 2



IF/RF MICROWAVE COMPONENTS • ISO 9001 ISO 14001 AS 9100 CERTIFIED • RoHS compliant
P.O. Box 350166, Brooklyn, New York 11235-0006 (718) 934-4500 Fax (718) 332-4661



The Design Engineers Search Engine finds the model you need, Instantly • For detailed performance specs & shopping online see



5 Way-0° Power Splitter/Combiner

SCP-5-1+

Typical Performance Curves

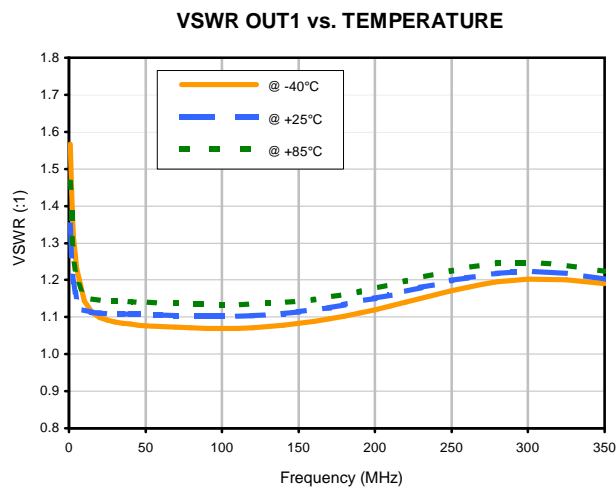
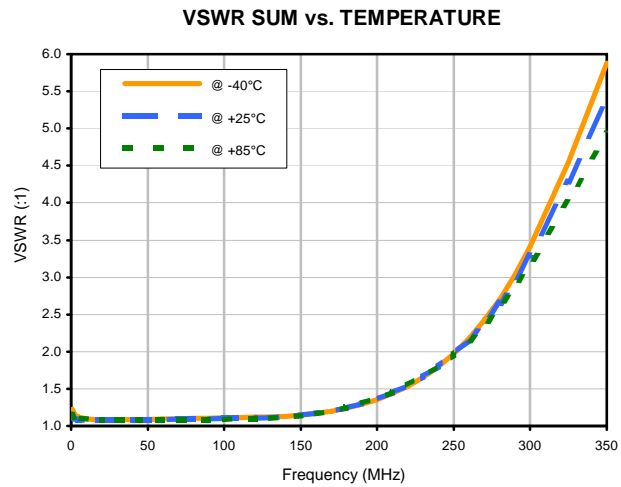
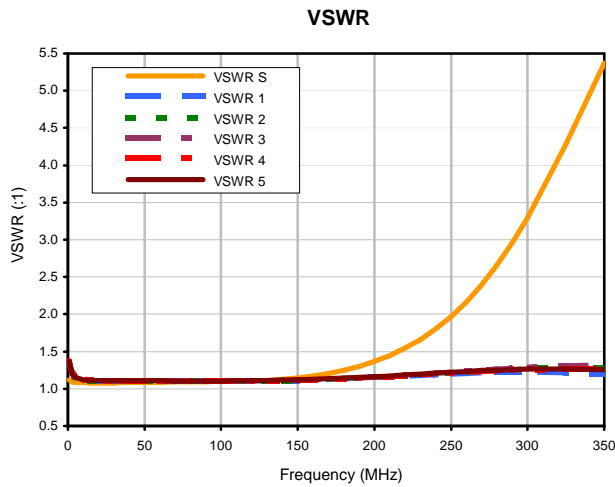

REV. X2
SCP-5-1+
100627
Page 2 of 2



IF/RF MICROWAVE COMPONENTS • ISO 9001 ISO 14001 AS 9100 CERTIFIED RoHS compliant
P.O. Box 350166, Brooklyn, New York 11235-0006 (718) 934-4500 Fax (718) 332-4661



The Design Engineers Search Engine finds the model you need, Instantly • For detailed performance specs & shopping online see



Case Style

YY

Outline Dimensions

YY101
YY109
YY161

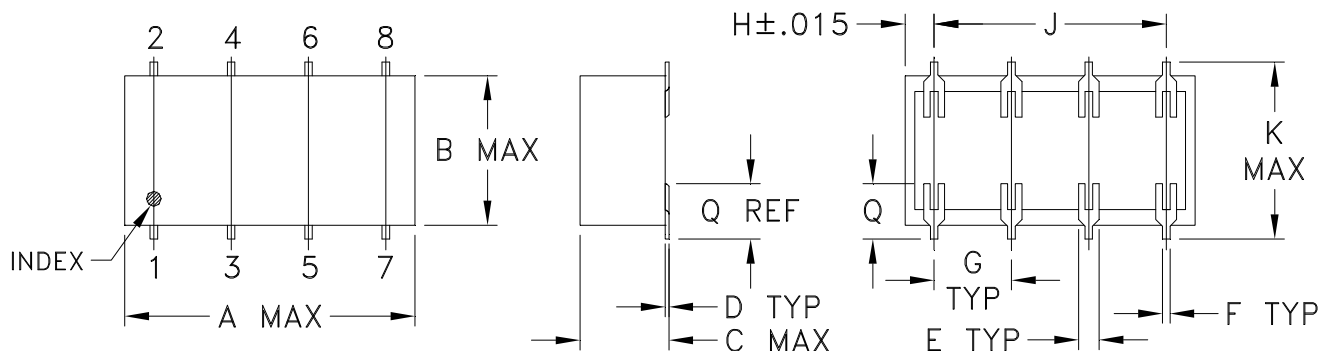

PCB Land Pattern

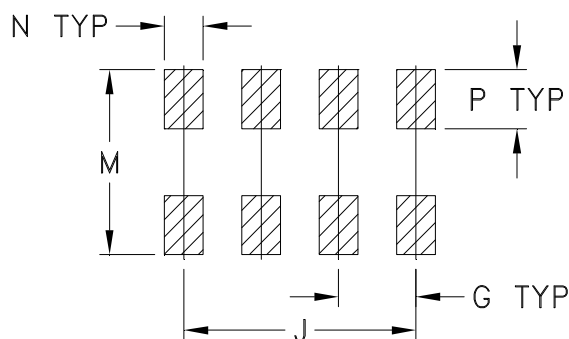

Suggested Layout
Tolerance to be within $\pm .002$

CASE#	A	B	C	D	E	F	G	H	J	K	L	M	N	P	Q	WT. GRAMS
YY101*			.20 (5.08)							.450 (11.43)	-- (11.94)	.470 (11.94)				1.6
YY109*	.75 (19.05)	.38 (9.65)	.20 (5.08)	.010 (0.25)	.050 (1.27)	.020 (0.51)	.200 (5.08)	.075 (1.91)	.600 (15.24)	.720 (18.29)	-- (18.80)	.740 (18.80)	.100 (2.54)	.150 (3.81)	.148 (3.76)	1.6
YY161			.28 (7.11)							.450 (11.43)	-- (11.94)	.470 (11.94)				1.6

Dimensions are in inches (mm). Tolerances: 2 Pl. $\pm .01$; 3 Pl. $\pm .005$

Notes:

- Case material: Plastic.
- Termination finish:
For RoHS Case Styles: Tin plate over Nickel plate.
For RoHS-5 Case Styles: Tin-Lead plate.
- Special Tolerances: Termination thickness $\pm .003$ inch.
- * Denotes: For SCM mixers, long termination version (case YY109) is available upon request, consult factory. To order short termination version (case YY101) add -NL suffix.

Mini-Circuits®

INTERNET <http://www.minicircuits.com>

P.O. Box 350166, Brooklyn, New York 11235-0003 (718) 934-4500 Fax (718) 332-4661

Distribution Centers NORTH AMERICA 800-654-7949 • 417-335-5935 • Fax 417-335-5945 • EUROPE 44-1252-832600 • Fax 44-1252-837010

Mini-Circuits ISO 9001 & ISO 14001 Certified

Tape & Reel Packaging TR-F5

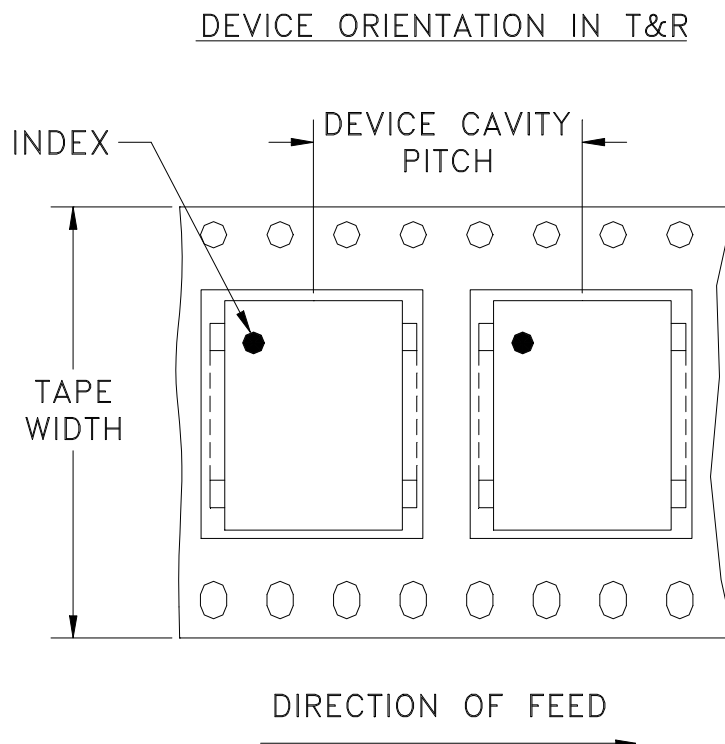

Tape Width, mm	Device Cavity Pitch, mm	Reel Size, inches	Devices per Reel
32	16	13	500

Mini-Circuits carrier tape materials provide protection from ESD (Electro-Static Discharge) during handling and transportation. Tapes are static dissipative and comply with industry standards EIA-481/EIA-541.

Go to: www.minicircuits.com/pages/pdfs/tape.pdf



Distribution Centers NORTH AMERICA 800-654-7949 • 417-335-5935 • Fax 417-335-5945 • EUROPE 44-1252-832600 • Fax 44-1252-837010

Mini-Circuits ISO 9001 & ISO 14001 Certified

INTERNET <http://www.minicircuits.com>

P.O. Box 350166, Brooklyn, New York 11235-0003 (718) 934-4500 Fax (718) 332-4661

THIRD ANGLE PROJECTION

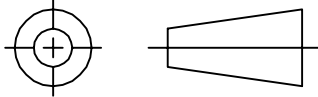

REVISIONS

REV	ECN No.	DESCRIPTION	DATE	DR	AUTH
OR	M82545	NEW RELEASE	01/28/05	MMG	HY
A	M102713	ADDED "...WITH SMOBC"	01/14/06	GF	IL

SUGGESTED MOUNTING CONFIGURATION
FOR YY161 CASE STYLE, "md" PIN CONNECTION

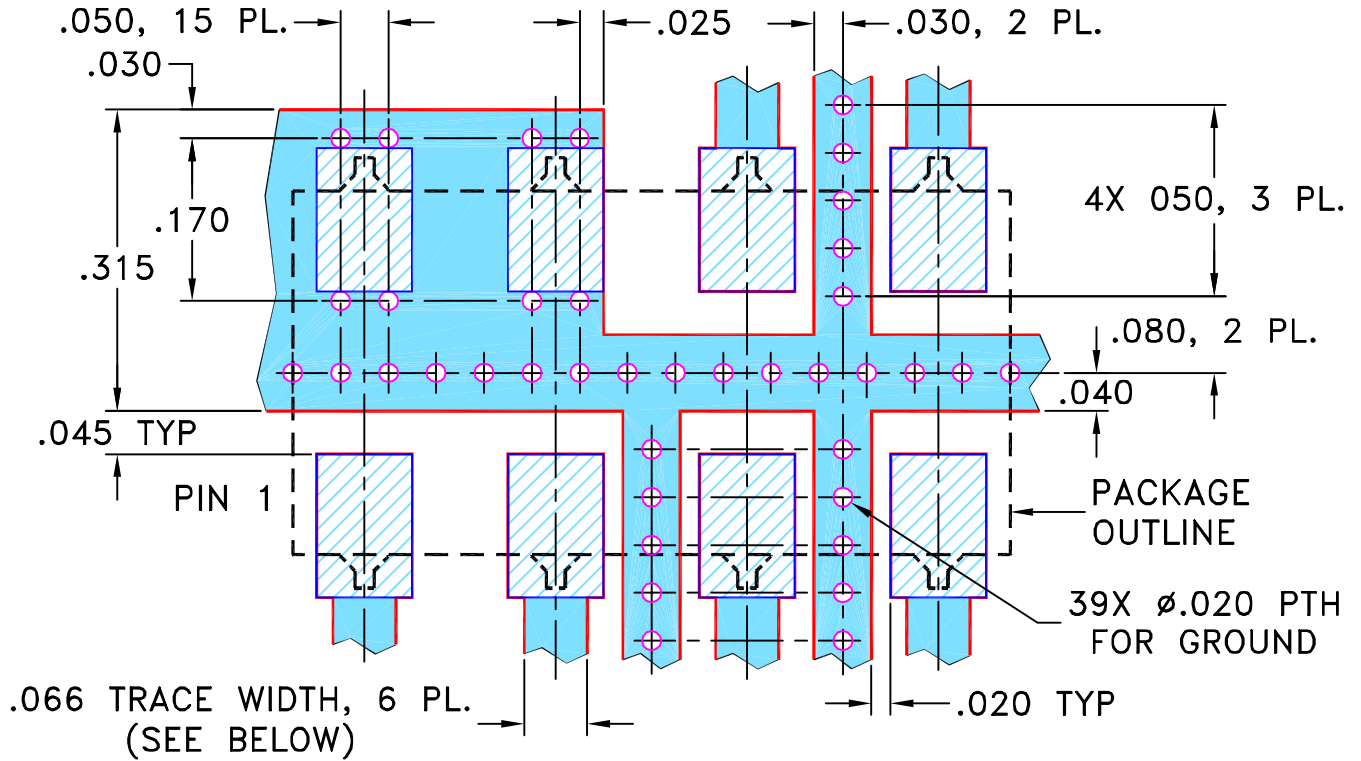

NOTES: 1. TRACE WIDTH IS SHOWN FOR ROGERS R04350B WITH DIELECTRIC THICKNESS 0.030" \pm 0.002"; COPPER: 1/2 OZ. EACH SIDE. FOR OTHER MATERIALS TRACE WIDTH MAY NEED TO BE MODIFIED.

2. BOTTOM SIDE OF THE PCB IS CONTINUOUS GROUND PLANE.



DENOTES PCB COPPER LAYOUT WITH SMOBC (SOLDER MASK OVER BARE COPPER)

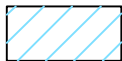

DENOTES COPPER LAND PATTERN FREE OF SOLDER MASK

UNLESS OTHERWISE SPECIFIED	INITIALS	DATE
DRAWN	MMG	01/24/05
CHECKED	AV	01/28/05
APPROVED	HY	01/28/05

DIMENSIONS ARE IN INCHES
TOLERANCES ON:
2 PL DECIMALS \pm
3 PL DECIMALS \pm .005
ANGLES \pm
FRACTIONS \pm

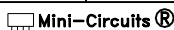

THIS DOCUMENT AND ITS CONTENTS ARE THE PROPERTY OF MINI-CIRCUITS. EXCEPT FOR USE EXPRESSLY GRANTED, IN WRITING, TO ITS VENDORS, VENDEE AND THE UNITED STATES GOVERNMENT, MINI-CIRCUITS RESERVES ALL PROPRIETARY DESIGN, USE, MANUFACTURING AND REPRODUCTION RIGHTS THERETO. THESE CONTENTS SHALL NOT BE USED, DUPLICATED OR DISCLOSED TO ANY OUTSIDE PARTY, IN WHOLE OR IN PART, WITHOUT WRITTEN PERMISSION OF MINI-CIRCUITS.

ASHEETA1.DWG REV:A DATE:01/12/95

 **Mini-Circuits**[®] 13 Neptune Avenue
Brooklyn NY 11235

PL, md, YY161, SCP-5-1, TB-213

SIZE	CODE IDENT	DRAWING NO:	REV:
A	15542	98-PL-104	A
FILE:	98PL104	SCALE: 5:1	SHEET: 1 OF 1

Evaluation Board and Circuit

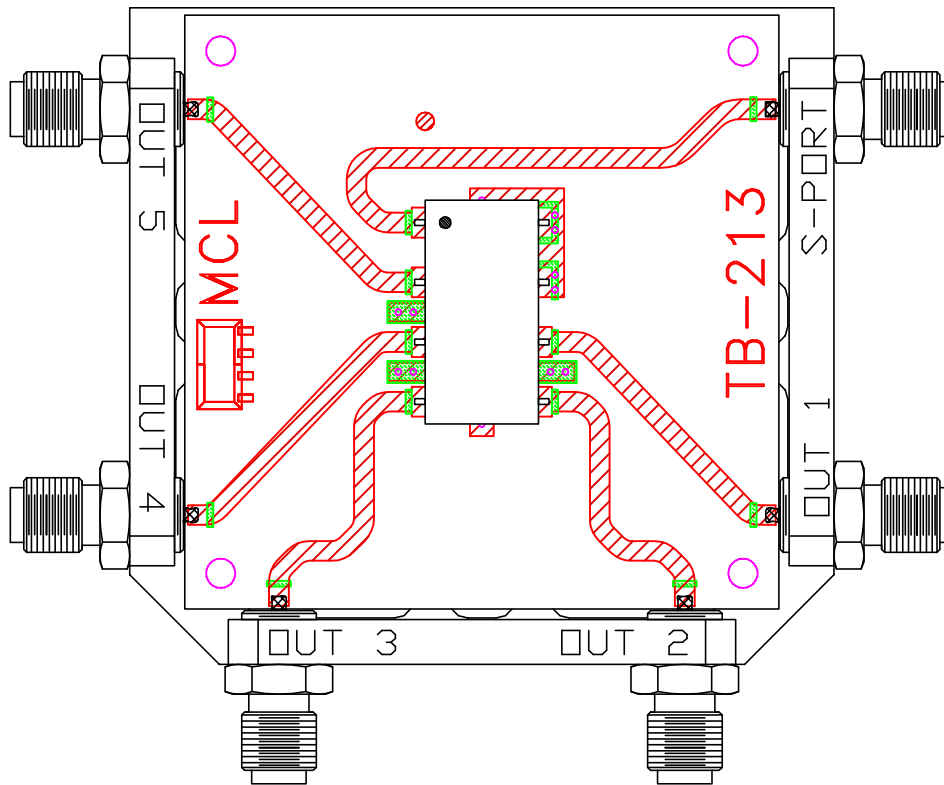

TB-213

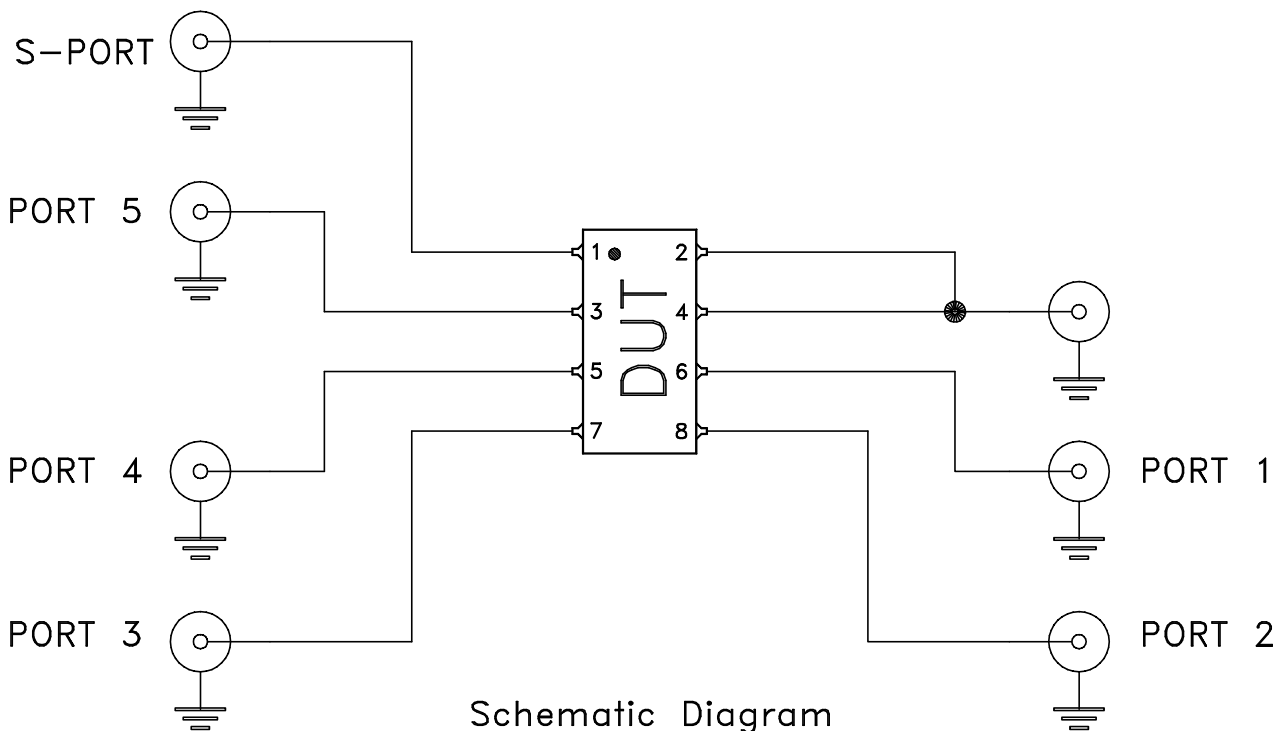

Schematic Diagram

Notes:

1. 50 Ohm SMA Female connectors.
2. PCB Material: R04350 or equivalent.
Dielectric Constant=3.5, Thickness=.030 inch.

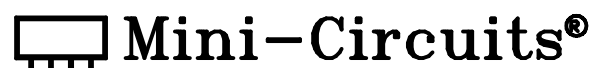



All Mini-Circuits products are manufactured under exacting quality assurance and control standards, and are capable of meeting published specifications after being subjected to any or all of the following physical and environmental test.

Specification	Test/Inspection Condition	Reference/Spec
Operating Temperature	-40° to 85°C Ambient Environment	Individual Model Data Sheet
Storage Temperature	-55° to 100° C Ambient Environment	Individual Model Data Sheet
Humidity	90 to 95% RH, 240 hours, 50°C	MIL-STD-202, Method 103, Condition A, Except 50°C and end-point electrical test done within 12 hours
Thermal Shock	-55° to 100°C, 100 cycles	MIL-STD-202, Method 107, Condition A-3, except +100°C
Solder Reflow Heat	Sn-Pb Eutetic Process: 225°C peak Pb-Free Process 245° - 250°C peak	J-STD-020, Table 4-1, 4-2 and 5-2, Figure 5-1
Solderability	10X Magnification	J-STD-002, 95% Coverage
Vibration (High Frequency)	20g peak, 10-2000 Hz, 12 times in each of three perpendicular directions (total 36)	MIL-STD-202, Method 204, Condition D
Mechanical Shock	50g, 11 ms, 1/2-sine, 18 shocks: 3 each direction, each of 3 axes	MIL-STD-202, Method 213, Condition A
Marking Resistance to Solvents	Isopropyl alcohol + mineral spirits at 25°C; terpene defluxer at 25°C; distilled water + proylene glycol monomethyl ether + monoethanolamine at 63°C to 70°C	MIL-STD-202, Method 215