



TGA2585-SM

2.7 to 3.7 GHz, 18 W GaN Power Amplifier

Product Overview

Qorvo's TGA2585-SM is a packaged MMIC power amplifier which operates from 2.7 to 3.7 GHz. The TGA2585-SM is designed using Qorvo's production 0.25- μm GaN on SiC process.

The TGA2585-SM typically provides 42.5 dBm of saturated output power, > 50% power-added efficiency, and 32 dB small signal gain. It can operate under both pulse and CW conditions.

The TGA2585-SM is available in a low-cost, surface mount 32 lead 5 x 5 AIN QFN. It is ideally suited to support both commercial and defense related radar applications.

Both RF ports have integrated DC blocking capacitors and are fully matched to 50 ohms.

Lead-free and RoHS compliant

Functional Block Diagram

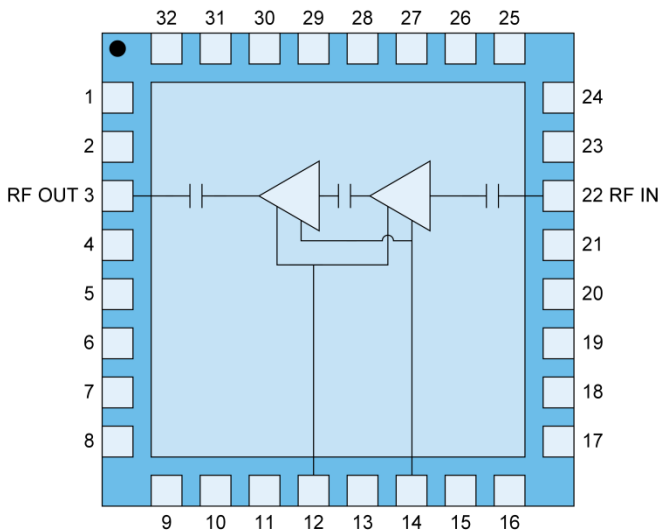

Air Cavity Package

Key Features

- Frequency Range: 2.7 - 3.7 GHz
- P_{SAT} : 42.5 dBm
- PAE: > 50 %
- Small Signal Gain: 32 dB
- Return Loss: > 10 dB
- Bias: $V_D = 28$ V (CW or Pulsed), $I_{DQ} = 225$ mA,
- Package Dimensions: 5.0 x 5.0 x 1.45 mm

Applications

- Commercial and Military Radar

Ordering Information

Part	Description
TGA2585-SM	2.7–3.7 GHz, 18 W GaN Power Amplifier
TGA2585-SMEVBP01	Evaluation Board

Absolute Maximum Ratings

Parameter	Value/Range
Drain Voltage (V_D)	40 V
Gate Voltage Range (V_G)	-8 to 0 V
Drain Current (I_D)	1530 mA
Gate Current (I_G)	-7 to 11.5 mA
Power Dissipation (P_{DISS}), 85 °C	35 W
Input Power (P_{IN}), CW, 50 Ω , 85 °C	30 dBm
Input Power (P_{IN}), CW, VSWR 10:1, $V_D = 28$ V, 85 °C	23 dBm
Mounting Temperature (30 Seconds)	260 °C
Storage Temperature	-55 to 150 °C

Operation of this device outside the parameter ranges given above may cause permanent damage. These are stress ratings only, and functional operation of the device at these conditions is not implied.

Recommended Operating Conditions

Parameter	Value/Range
Drain Voltage (V_D)	28 V
Drain Current (I_{DQ})	225 mA
Drain Current Under RF Drive (I_{D_DRIVE})	See plots p. 7
Gate Voltage Range (V_G)	-2.8 to -2.0 V
Gate Current Under RF Drive (I_{G_DRIVE})	See plots p. 7

Electrical Specifications

Test conditions unless otherwise noted: 25 °C, $V_D = 28\text{ V}$, $I_{DQ} = 225\text{ mA}$, Pulsed V_D : $PW = 100\text{ us}$, $DC = 10\%$

Parameter	Min	Typ	Max	Units
Operational Frequency Range	2.7		3.7	GHz
Small Signal Gain		32		dB
Input Return Loss		> 15		dB
Output Return Loss		> 10		dB
Output Power at Saturation ($P_{IN} = 18\text{ dBm}$)	41.8	42.5		dBm
Power-Added Efficiency ($P_{IN} = 18\text{ dBm}$)	45	> 50		%
Gain Temperature Coefficient		-0.05		dB/°C
Power Temperature Coefficient		-0.005		dBm/°C
Gate Leakage ($V_d=10\text{V}$, $V_g=-3.7\text{V}$)	-7.83	-0.1	-0.0001	mA

Electrical specifications are measured at specified test conditions. Specifications are not guaranteed over all recommended operating conditions.

Thermal and Reliability Information

Parameter	Test Conditions	Value	Units
Thermal Resistance (θ_{JC}) ¹	T _{BASE} = 85 °C, V _D = 28 V, Pulse: PW = 100 us, DC = 10%, Freq = 3 GHz, P _{IN} = 18 dBm: I _{DQ} = 225 mA, I _{D_Drive} = 1330 mA, P _{OUT} = 42.7 dBm, P _{DISS} = 18.6 W	2.50	°C/W
Channel Temperature (T _{CH}) (Under RF drive) ²		131.5	°C

Notes:

1. Thermal resistance referenced to the back of the package.
2. IR scan equivalent. Refer to the following document: [GaN Device Channel Temperature, Thermal Resistance, and Reliability Estimates](#)

Power Dissipation

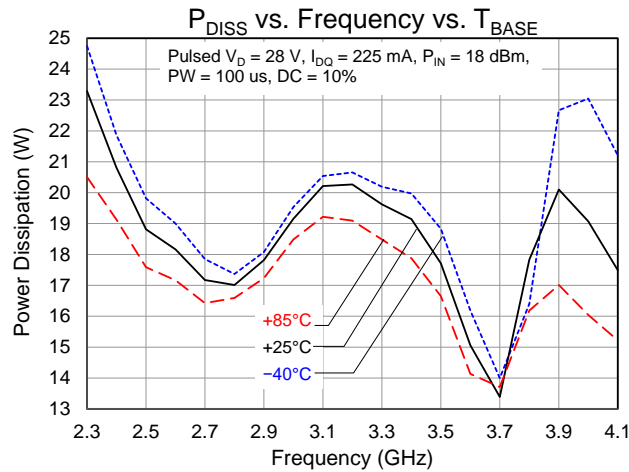

Typical Performance: Small Signal

Condition: CW

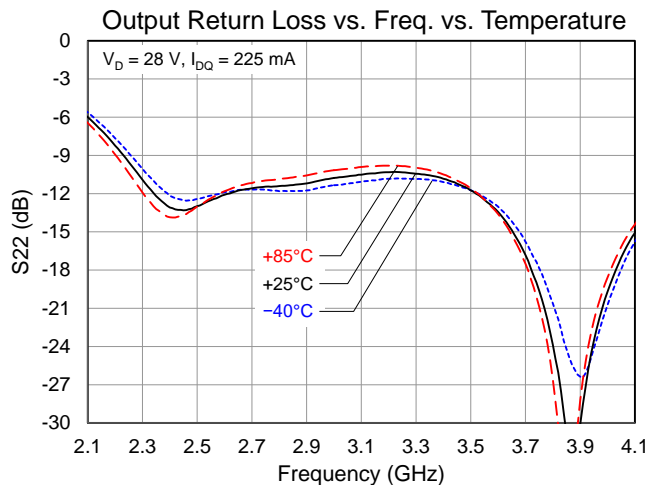
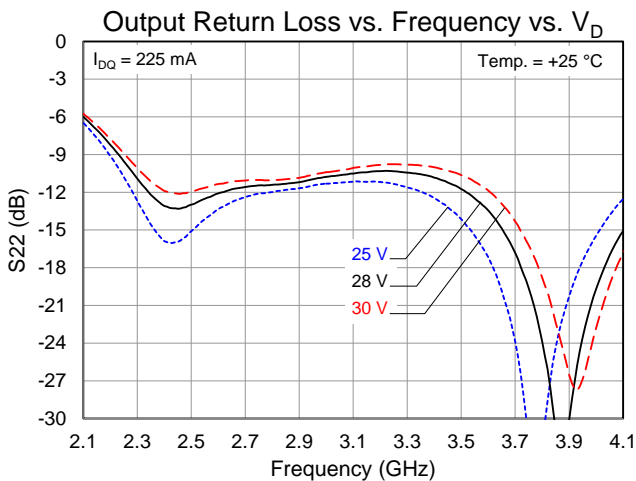
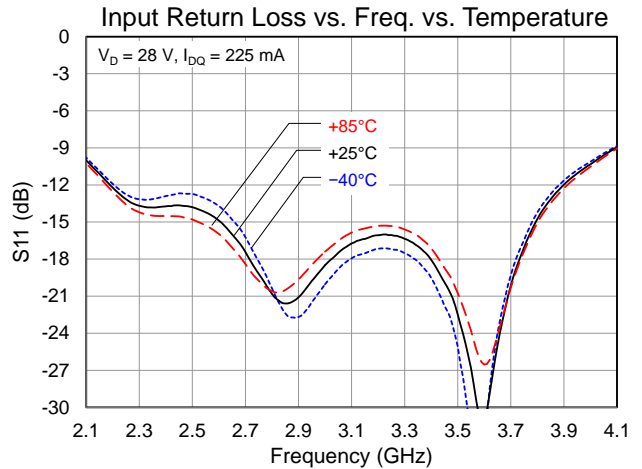
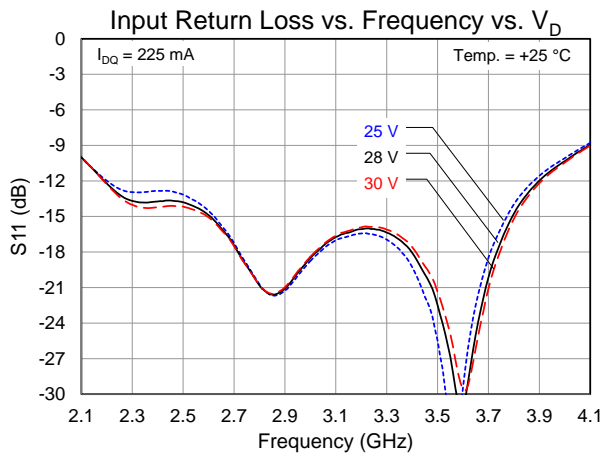
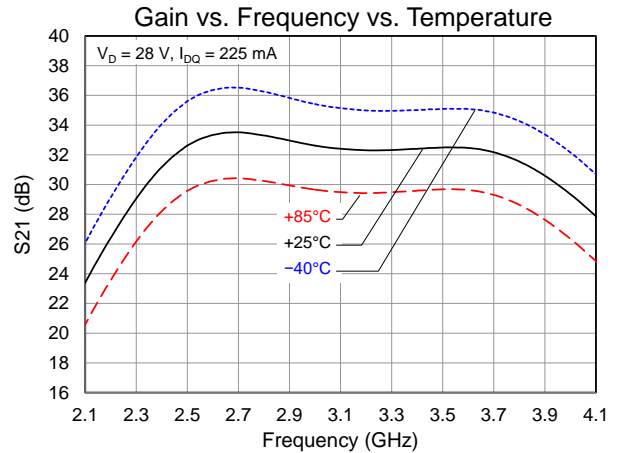
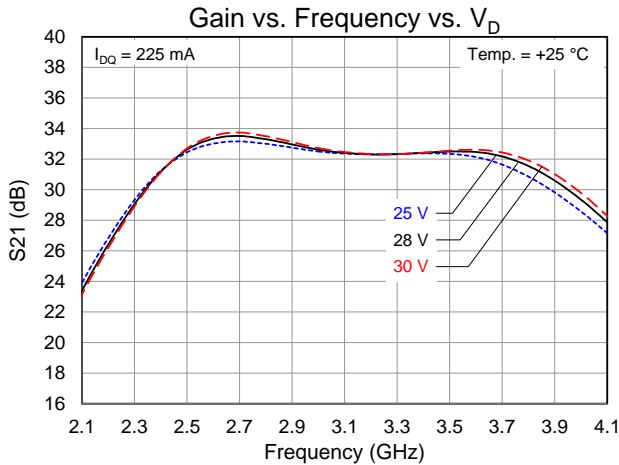

Typical Performance: Large Signal

Condition: Pulsed V_D , Pulse Width = 100 us, Duty Cycle = 10%

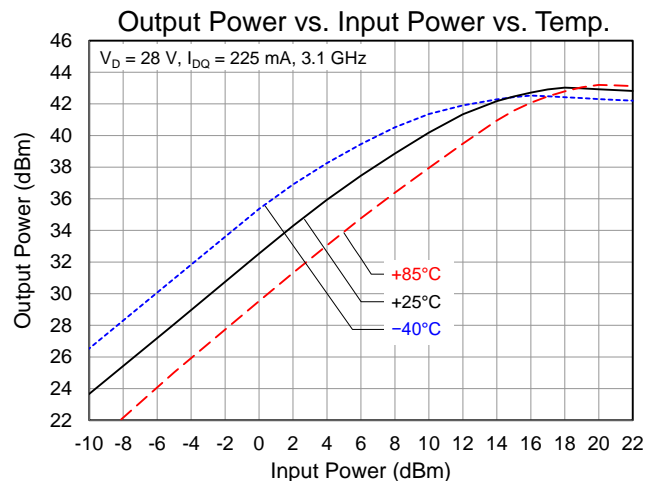
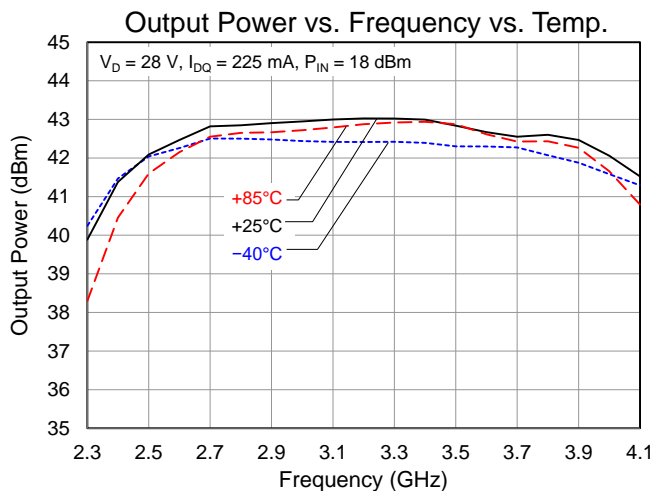
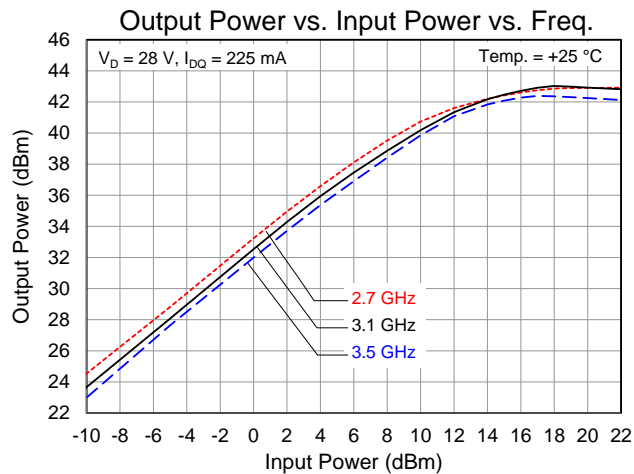
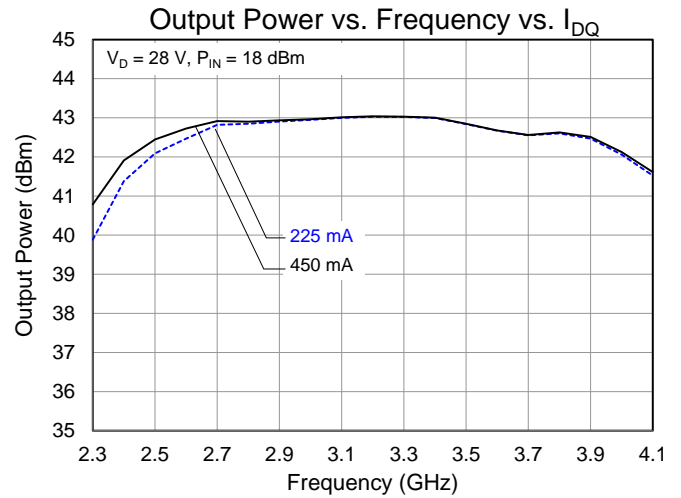
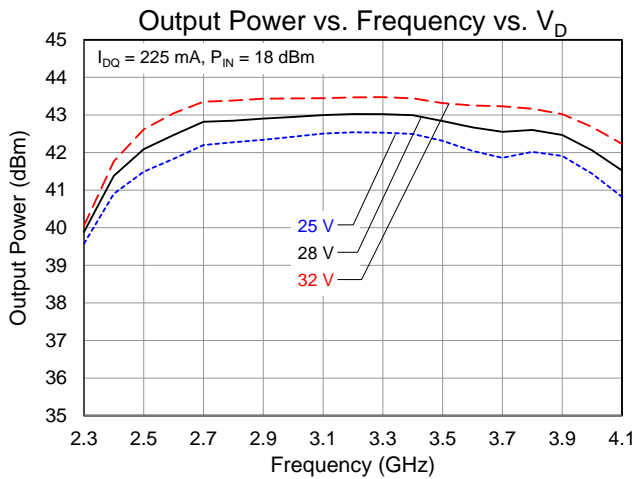

Typical Performance: Large Signal

Condition: Pulsed V_D , Pulse Width = 100 us, Duty Cycle = 10%

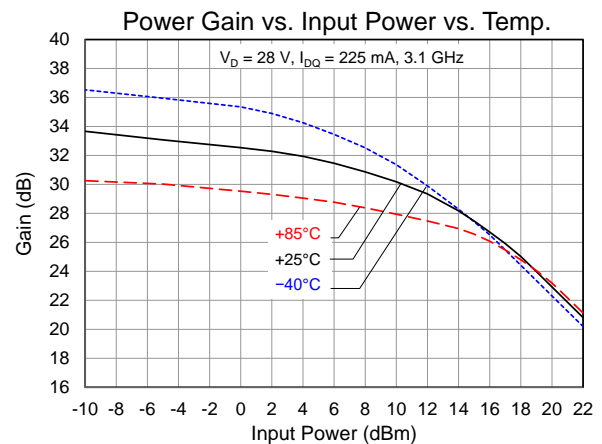
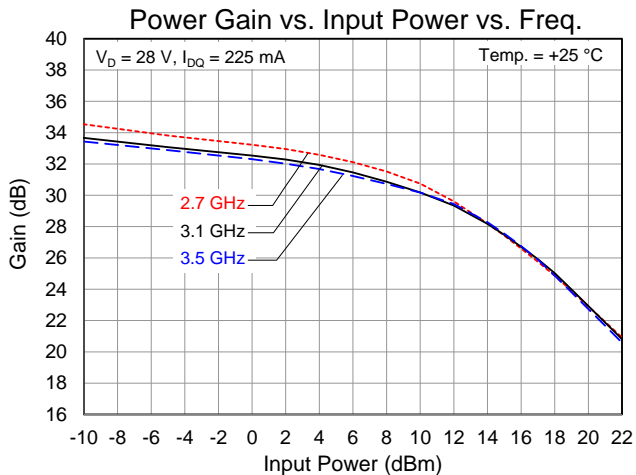
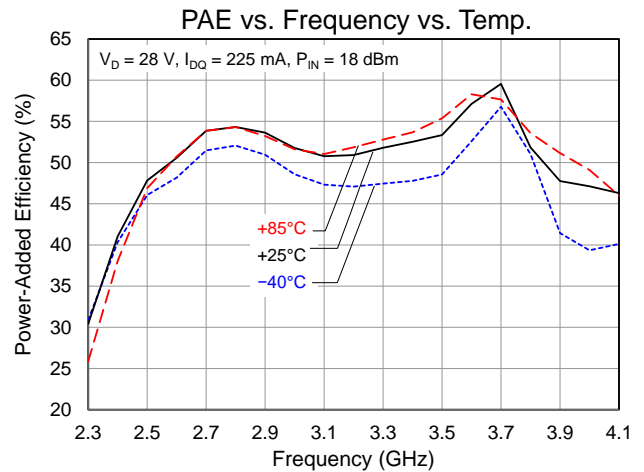
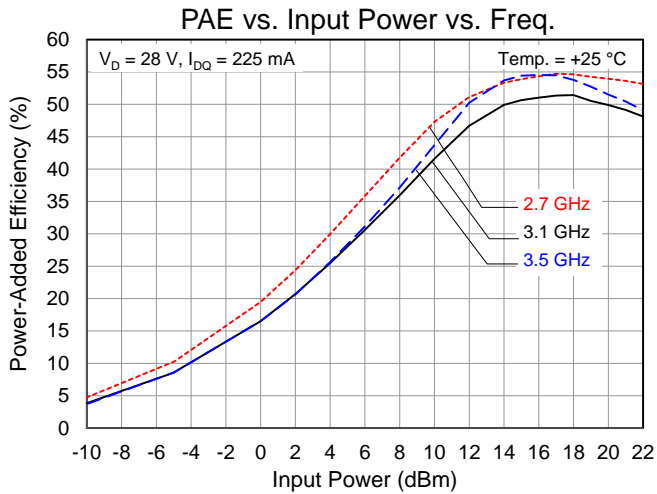
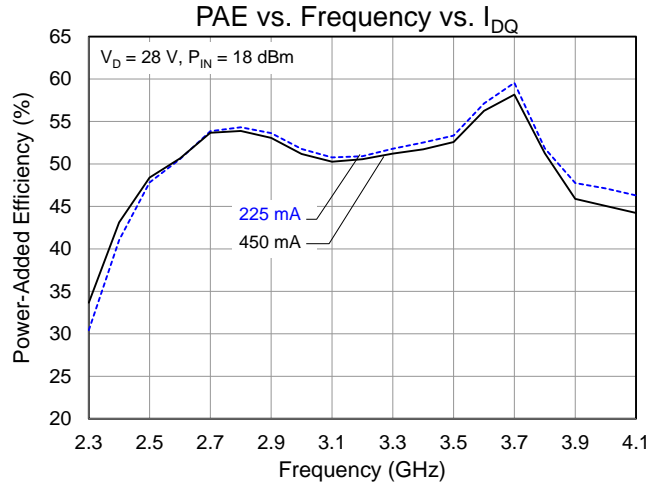
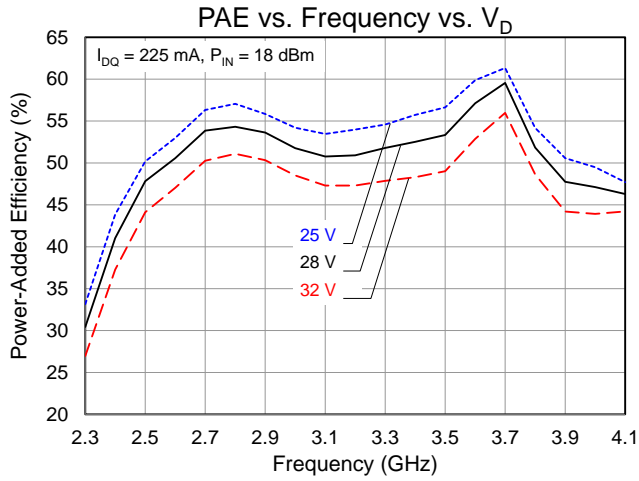

Typical Performance: Large Signal

Condition: Pulsed V_D , Pulse Width = 100 us, Duty Cycle = 10%

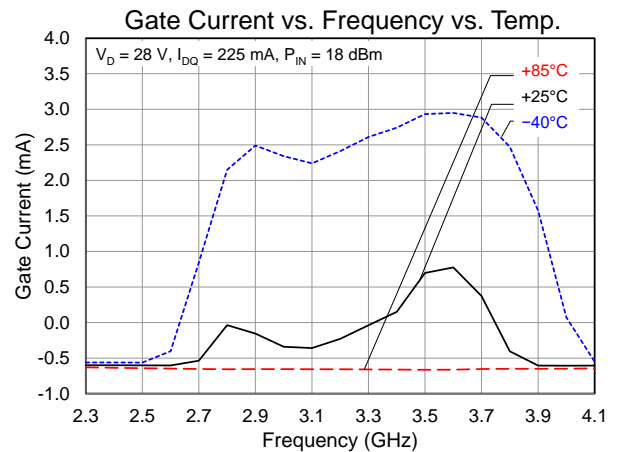
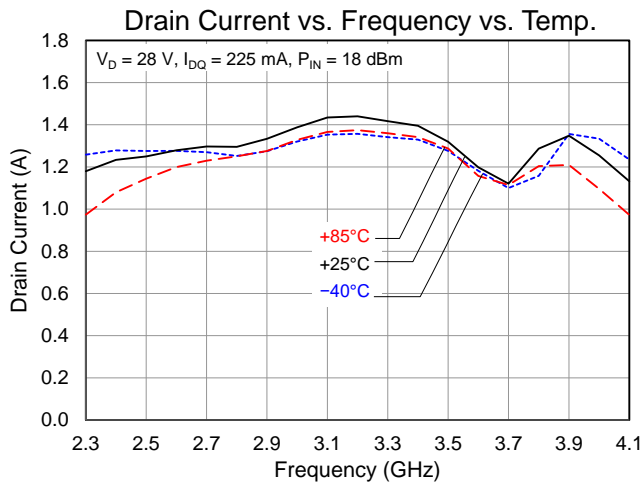
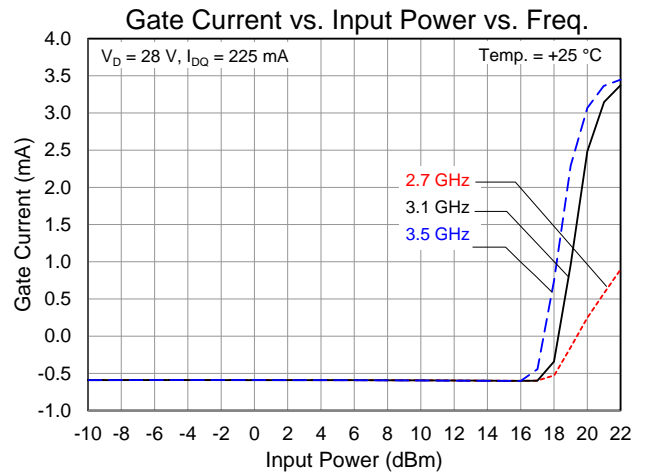
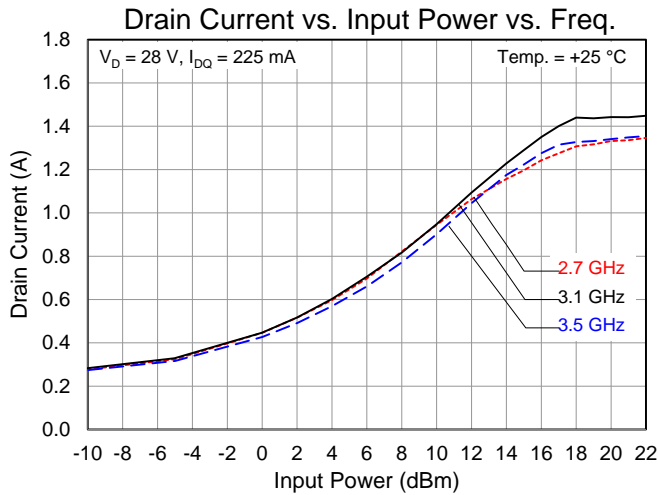
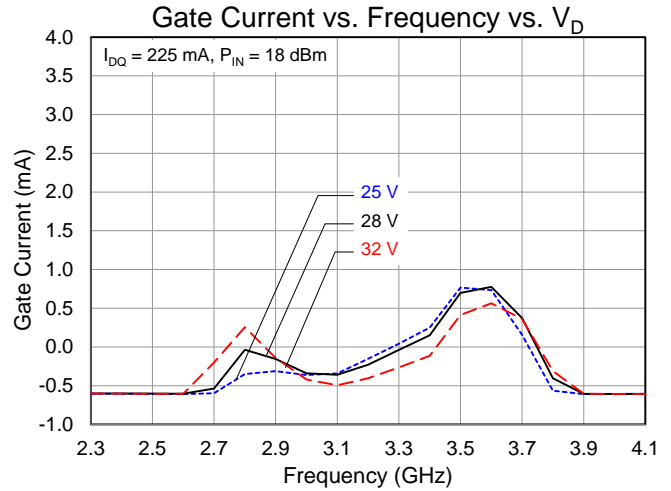
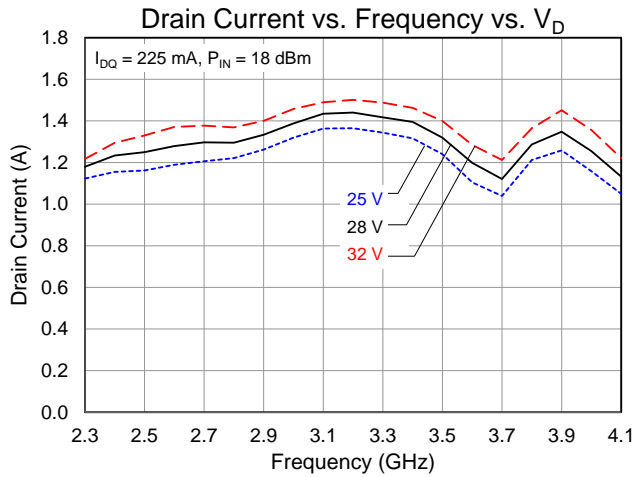

Applications Information

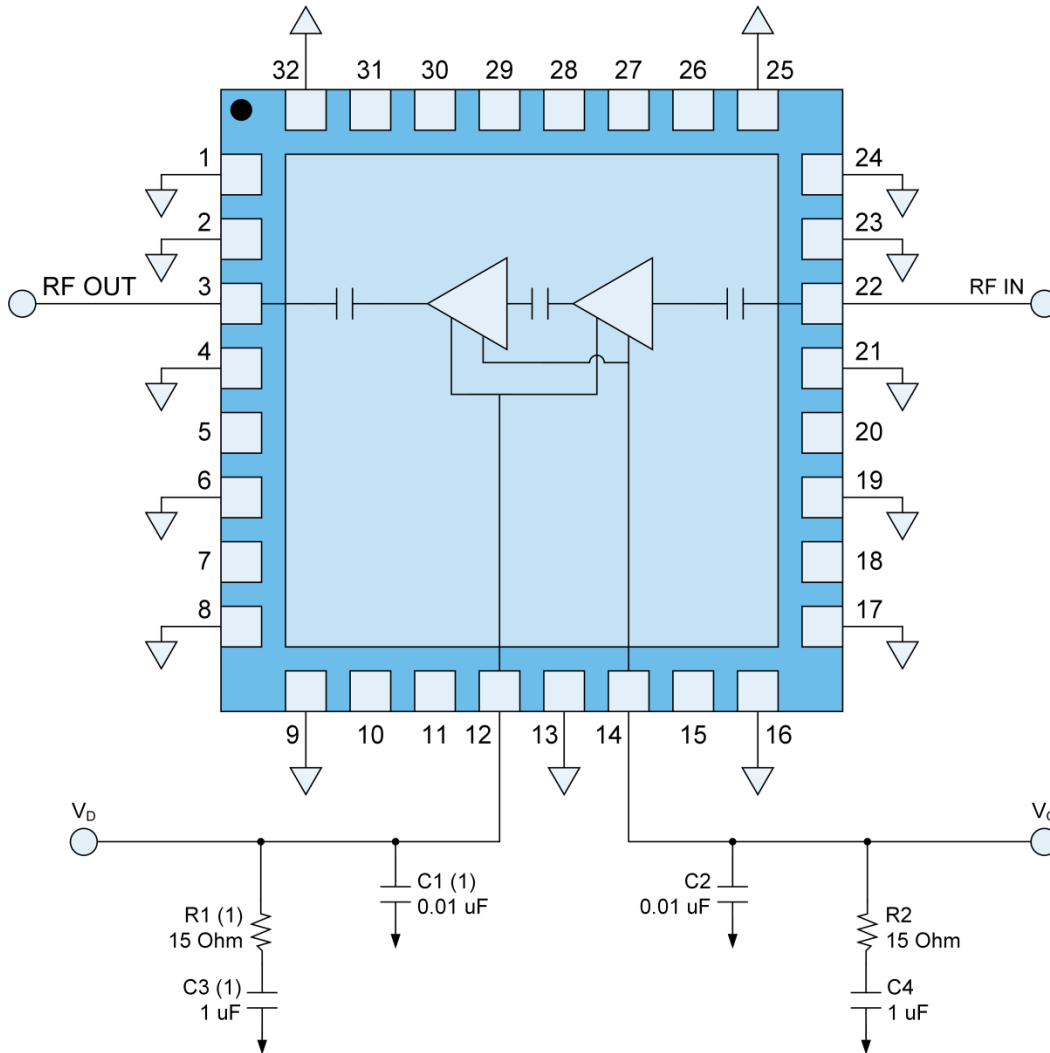

Notes:

1. Remove if pulsing on drain

Bias-up Procedure

1. Set I_D limit to 1.53 A, I_G limit to 8 mA
2. Apply -5 V to V_G
3. Apply +28 V to V_D ; ensure I_{DQ} is approx. 0 mA
4. Adjust V_G until $I_{DQ} = 225$ mA ($V_G \sim -2.5$ V Typ.).
5. Turn on RF supply

Bias-down Procedure

1. Turn off RF supply
2. Reduce V_G to -5 V; ensure I_{DQ} is approx. 0 mA
3. Set V_D to 0 V
4. Turn off V_D supply
5. Turn off V_G supply

Pin Layout

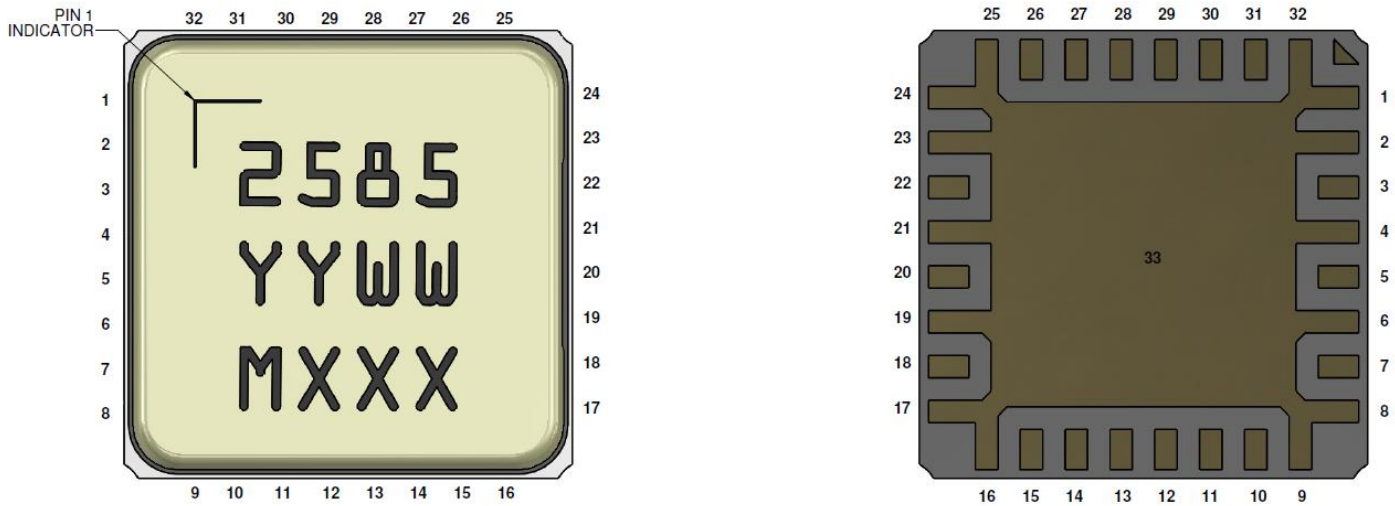

Pin Number	Symbol	Description
1, 2, 4, 6, 8, 9, 13, 16, 17, 19, 21, 23, 24, 25, 32	GND	Connected to ground paddle (pin 33); must be grounded on PCB.
3	RF OUT	Output; matched to 50 Ω ; DC blocked.
5, 7, 10, 11, 15, 18, 20, 26-31	NC	No connection. May be grounded to PCB to improve package attachment.
12	DRAIN	Drain voltage; bias network is required; see recommended Application Information on page 8.
14	GATE	Gate voltage; bias network is required; see recommended Application Information on page 8.
22	RF IN	Input; matched to 50 Ω ; DC blocked.
33	GND	Ground Paddle. Multiple vias should be employed to minimize inductance and thermal resistance.

Evaluation Board Layout and Bill of Materials

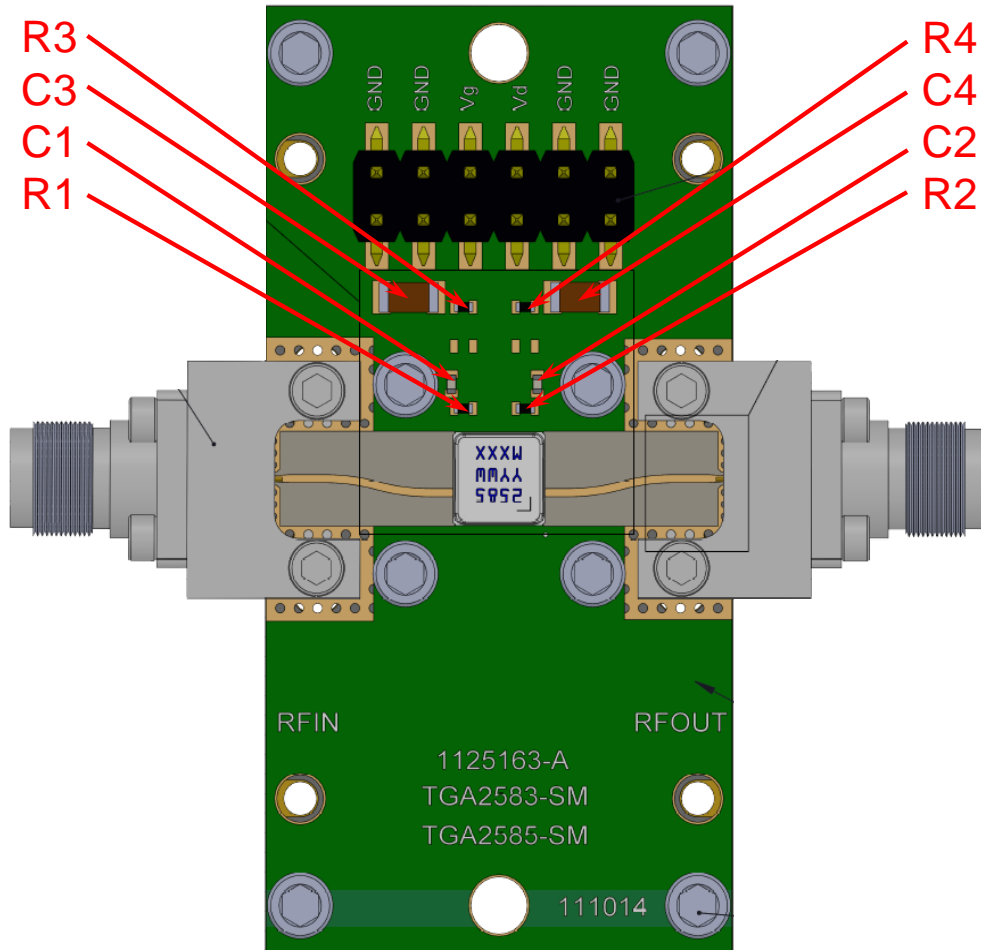

Reference Des.	Value	Description	Manuf.	Part Number
C1, C2	0.01 μ F	Cap, 0402, 50 V, 10%, X7R	Various	
C3, C4	1 μ F	Cap, 0805, 50 V, 10%, X7R	Various	
R1, R2	0 Ohm	Res, 0402, 5%	Various	
R3, R4	15 Ohm	Res, 0402, 5%	Various	
J1, J2	2.92 mm F	RF Connector end launch	SW Microwave	1092-01A-5

Mechanical Information

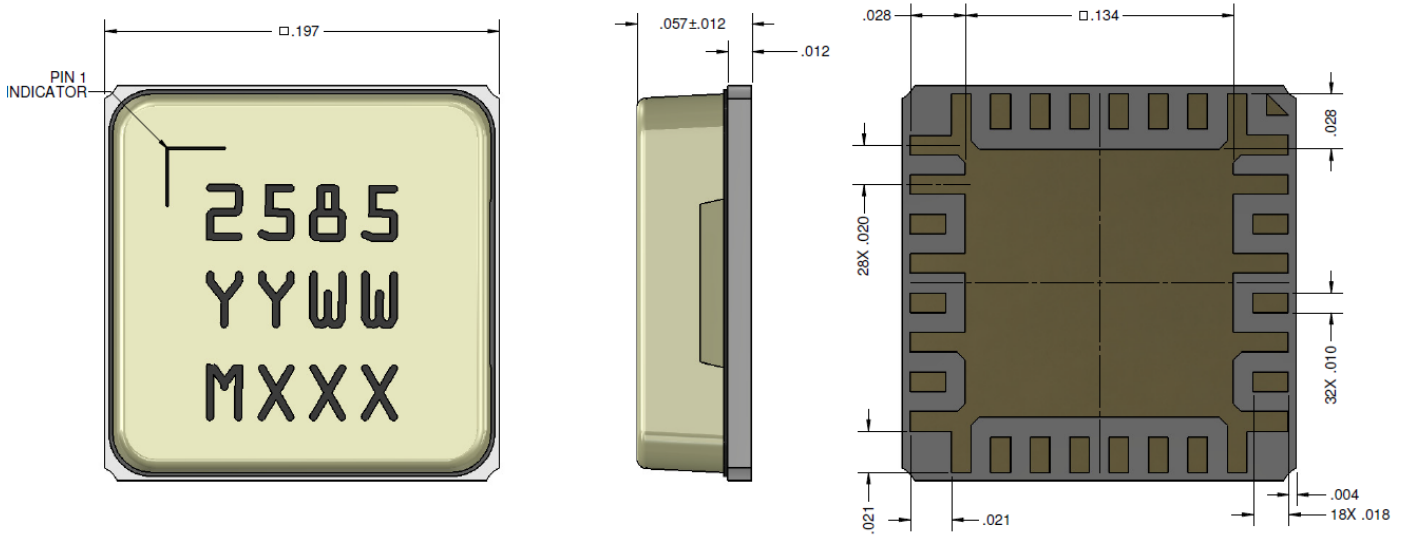

Units: Inches

Tolerances: unless specified

x.xx = ± 0.01

x.xxx = ± 0.005

Materials:

Base: Ceramic

Lid: Plastic

All metalized features are gold plated

Part is epoxy sealed

Marking:

2585: Part number

YY: Part Assembly year

WW: Part Assembly week

MXXX: Batch ID

Recommended Soldering Temperature Profile

Compatible with lead-free soldering processes with 260°C peak reflow temperature.

This package is air-cavity and non-hermetic, and therefore cannot be subjected to aqueous washing. The use of no-clean solder to avoid washing after soldering is highly recommended.

Contact plating: Ni-Au.

Solder rework not recommended.

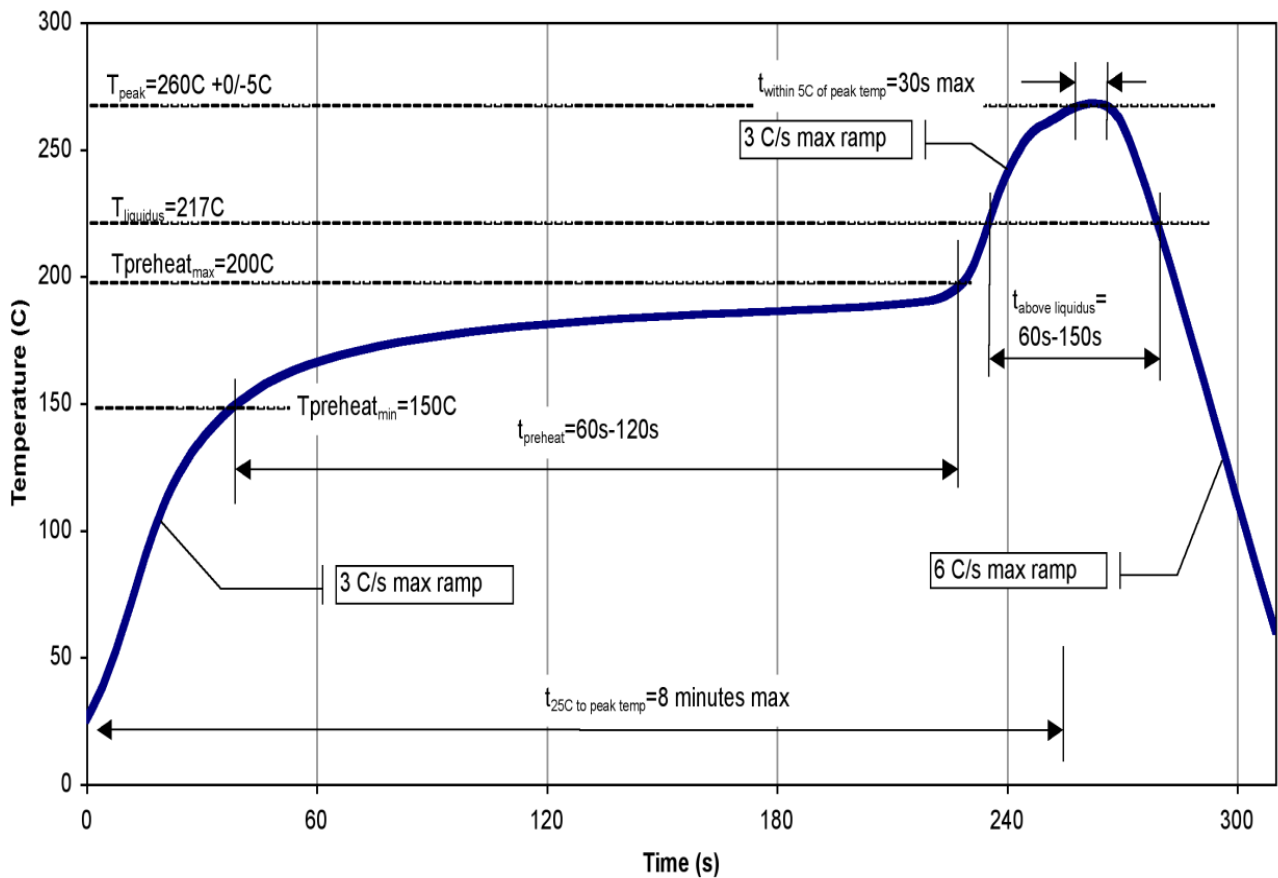

Recommended Soldering Temperature Profile

Handling Precautions

Parameter	Rating	Standard
ESD – Human Body Model (HBM)	1B	ANSI/ESD/JEDEC JS-001
ESD – Charge Device Model (CDM)	C3	ANSI/ESD/JEDEC JS-002
MSL – Moisture Sensitivity Level	MSL3	IPC/JEDEC J-STD-020



Caution!

ESD-Sensitive Device

RoHS Compliance

This part is compliant with 2011/65/EU RoHS directive (Restrictions on the Use of Certain Hazardous Substances in Electrical and Electronic Equipment) as amended by Directive 2015/863/EU.

This product also has the following attributes:

- Lead Free
- Antimony Free
- TBBP-A (C15H12Br4O2) Free
- PFOS Free
- Halogen Free
- SVHC Free

Contact Information

For the latest specifications, additional product information, worldwide sales and distribution locations:

Web: www.qorvo.com

Tel: 1-844-890-8163

Email: customer.support@qorvo.com

Important Notice

The information contained herein is believed to be reliable; however, Qorvo makes no warranties regarding the information contained herein and assumes no responsibility or liability whatsoever for the use of the information contained herein. All information contained herein is subject to change without notice. Customers should obtain and verify the latest relevant information before placing orders for Qorvo products. The information contained herein or any use of such information does not grant, explicitly or implicitly, to any party any patent rights, licenses, or any other intellectual property rights, whether with regard to such information itself or anything described by such information. **THIS INFORMATION DOES NOT CONSTITUTE A WARRANTY WITH RESPECT TO THE PRODUCTS DESCRIBED HEREIN, AND QORVO HEREBY DISCLAIMS ANY AND ALL WARRANTIES WITH RESPECT TO SUCH PRODUCTS WHETHER EXPRESS OR IMPLIED BY LAW, COURSE OF DEALING, COURSE OF PERFORMANCE, USAGE OF TRADE OR OTHERWISE, INCLUDING THE IMPLIED WARRANTIES OF MERCHANTABILITY AND FITNESS FOR A PARTICULAR PURPOSE.**

Without limiting the generality of the foregoing, Qorvo products are not warranted or authorized for use as critical components in medical, life-saving, or life-sustaining applications, or other applications where a failure would reasonably be expected to cause severe personal injury or death.

Copyright 2020 © Qorvo, Inc. | Qorvo is a registered trademark of Qorvo, Inc.