



AH31

High Dynamic Range IF Amplifier

Product Features

- 50 – 1000 MHz
- 19 dB Gain
- +22 dBm P1dB
- +42 dBm OIP3
- 1.9 dB Noise Figure
- Single Voltage Supply (+5 V)
- Lead-free/Green/RoHS-compliant SOT-89 Package
- MTTF > 1000 years

Applications

- High linearity and low-noise amplifier following a mixer
- High performance amplifier in IF path of TX/RX systems

Specifications ⁽¹⁾

Parameter	Units	Min	Typ	Max
Operational Bandwidth	MHz	50		1000
Test Frequency	MHz		240	
Gain ⁽³⁾	dB		19	
Output P1dB	dBm		+22	
Output IP3 ⁽²⁾	dBm	+37	+42	
Supply Voltage	V		+5	
Operating Current Range	mA	120	150	180

1. Test conditions : T = 25 °C, Vdd = +5 V, 50 Ω system.
 2. 3OIP measured with two tones at an output power of +5 dBm/tone separated by 1 MHz. The suppression on the largest IM3 product is used to calculate the 3OIP using a 2:1 rule.

Product Description

The AH31 is a high dynamic range amplifier in a low-cost surface-mount package. The combination of low noise figure, high gain, and high output IP3 is ideal as an IF amplifier for receiver and transmitter applications.

The device combines dependable performance with consistent quality to maintain MTTF values exceeding 1000 years at mounting temperatures of +85 °C and is available in the environmentally-friendly lead-free/green/RoHS-compliant SOT-89 package. All devices are 100% RF & DC tested.

The MMIC amplifier based on GaAs MESFET technology can be configured for IF and RF applications with various current and next generation wireless technologies.

Functional Diagram

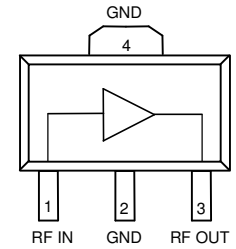

Function	Pin No.
Input	1
Output/Bias	3
Ground	2, 4

Typical Performance ⁽³⁾

Parameter	Units	Typical				
Frequency	MHz	75	170	240	500	900
S21	dB	19.5	19.2	19.3	18.4	16.6
S11	dB	-21	-13	-19	-13	-14
S22	dB	-17	-14	-13	-9.2	-9
Output P1dB	dBm	+22	+21	+22	+21	+20
Output IP3	dBm	+42	+42	+42	+41	+41
Noise Figure	dB	2.6	2.3	2.2	1.9	2.2

3. Typical parameters reflect performance in an application circuit.

Absolute Maximum Rating

Parameter	Rating
Operating Case Temperature	-40 to +85 °C
Storage Temperature	-55 to +150 °C
DC Voltage	+6 V
RF Input Power (continuous)	4 dB above Input P1dB
Junction Temperature	+220 °C

Operation of this device above any of these parameters may cause permanent damage.

Ordering Information

Part No.	Description
AH31-G	High Dynamic Range IF Amplifier (lead-free/green/RoHS-compliant SOT-89 Pkg)
AH31-PCB75	65 – 85 MHz Fully Assembled Evaluation Board
AH31-PCB170	155 – 185 MHz Fully Assembled Evaluation Board
AH31-PCB240	220 – 260 MHz Fully Assembled Evaluation Board
AH31-PCB500	450 – 550 MHz Fully Assembled Evaluation Board

Specifications and information are subject to change without notice



Typical Device Data

S-parameters ($V_d = +5\text{ V}$, $I_d = 150\text{ mA}$, unmatched $50\ \Omega$ system).

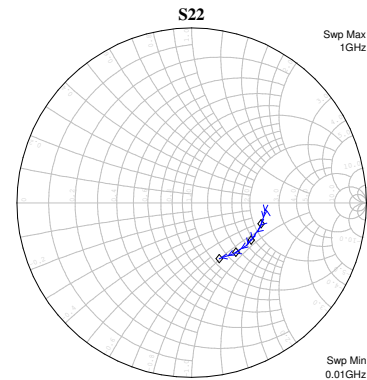
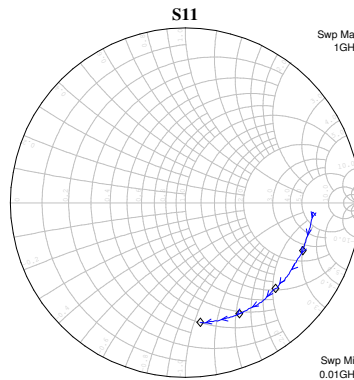
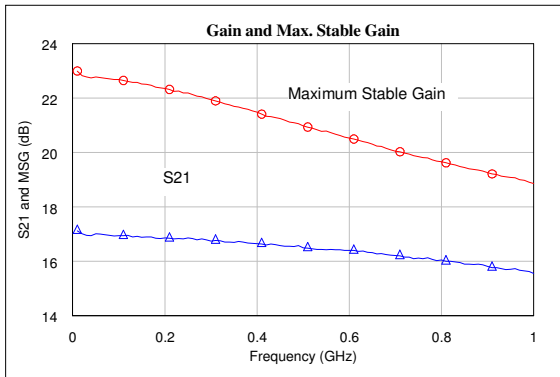

Notes:

- Measurements are shown for an unmatched packaged device with the data being de-embedded to the device leads.
- The amplifier requires a matching network at the input for proper operation. The amplifier is intrinsically well matched at the output and ideally should “look” into $50\ \Omega$. Any deviation from this can affect the linearity IP3 performance for the device.
- For a tuned circuit for a particular frequency, it is expected that actual gain will be higher, up to the maximum stable gain. The maximum stable gain is shown in the dashed red line.
- The impedance plots are shown from 250 – 1000 MHz, with markers placed at 0.25 – 1.0 GHz in 0.25 GHz increments.

Application Circuit PC Board Layout

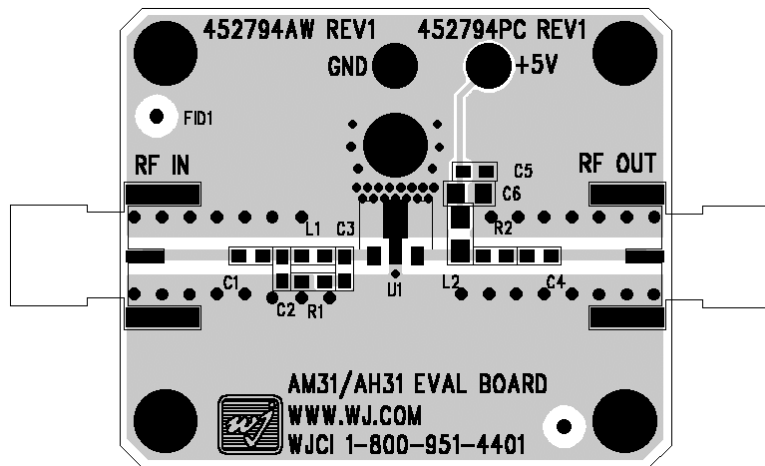

Circuit Board Material: .014" FR-4, 4 layers (other layers added for rigidity), .062" total thickness, 1 oz copper
Microstrip line details: width = .024", spacing = .036"

Typical Device Data

S-Parameters ($V_D = +5\text{ V}$, $I_D = 150\text{ mA}$, $T = 25\text{ }^\circ\text{C}$, calibrated to device leads)

Freq (MHz)	S11 (dB)	S11 (ang)	S21 (dB)	S21 (ang)	S12 (dB)	S12 (ang)	S22 (dB)	S22 (ang)
50	-2.72	-5.46	17.01	175.91	-28.54	6.89	-7.44	-5.46
100	-2.77	-9.52	16.94	172.89	-28.42	8.53	-7.56	-7.93
200	-2.81	-18.01	16.86	166.99	-27.86	14.09	-7.59	-13.42
300	-2.87	-26.32	16.74	161.33	-27.14	18.38	-7.63	-19.94
400	-2.87	-35.19	16.64	155.16	-26.32	21.01	-7.83	-26.57
500	-2.95	-43.58	16.50	149.45	-25.45	22.42	-7.92	-32.04
600	-2.91	-51.71	16.40	143.72	-24.66	22.73	-8.00	-38.12
700	-2.99	-60.03	16.21	138.07	-23.89	21.29	-8.31	-45.01
800	-3.03	-67.73	16.05	132.16	-23.27	19.94	-8.46	-50.89
900	-3.14	-75.45	15.81	126.99	-22.71	17.74	-8.77	-57.30
1000	-3.22	-82.88	15.55	121.64	-22.17	15.73	-8.95	-63.63



Application Circuit: 65 – 85 MHz (AH31-PCB75)

Typical Performance

Frequency	75 MHz
Gain	19.5 dB
S11	-21 dB
S22	-17 dB
Output P1dB	+22 dBm
Output IP3	+42 dBm
Noise Figure	2.6 dB
Bias	+5 V @ 150 mA

Notes:

1. The amplifier should be connected directly to a +5 V regulator; no dropping resistor is required.
2. If no DC signal is present at the input (pin 1), C1 can be removed. The gate is internally grounded in the amplifier.
3. R2 is used as a placeholder for a different application circuit. It can be removed from the circuit.
4. C2 (from the silkscreen) is not utilized in this application circuit.

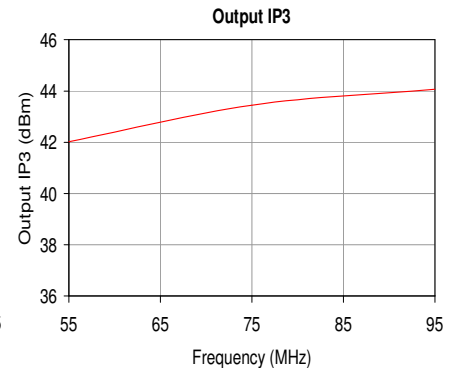
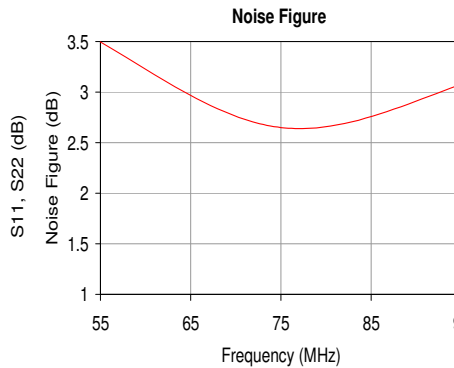
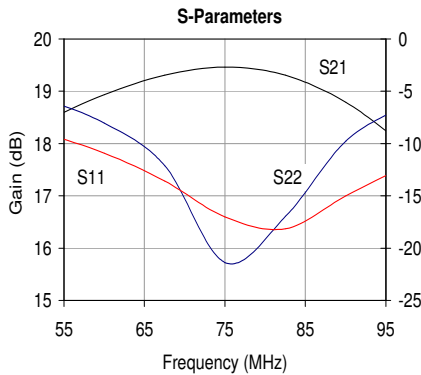
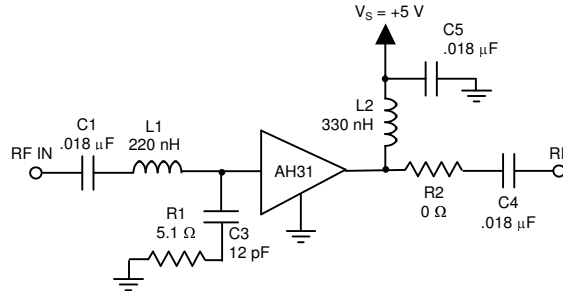

Application Circuit: 155 – 185 MHz (AH31-PCB170)

Typical Performance

Frequency	170 MHz
Gain	19.2 dB
S11	-13 dB
S22	-14 dB
Output P1dB	+21 dBm
Output IP3	+42 dBm
Noise Figure	2.3 dB
Bias	+5 V @ 150 mA

Notes:

1. The amplifier should be connected directly to a +5 V regulator; no dropping resistor is required.
2. If no DC signal is present at the input (pin 1), C1 can be removed. The gate is internally grounded in the amplifier.
3. R2 is used as a placeholder for a different application circuit. It can be removed from the circuit.
4. C2 (from the silkscreen) is not utilized in this application circuit.

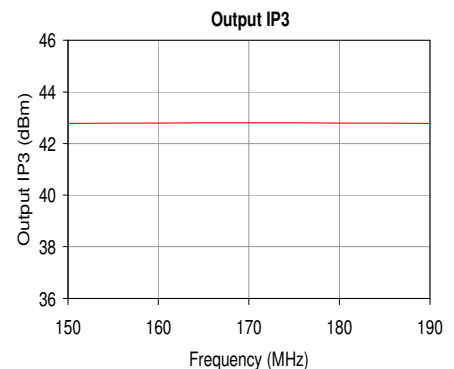
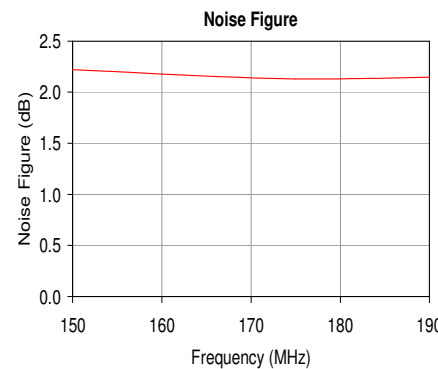
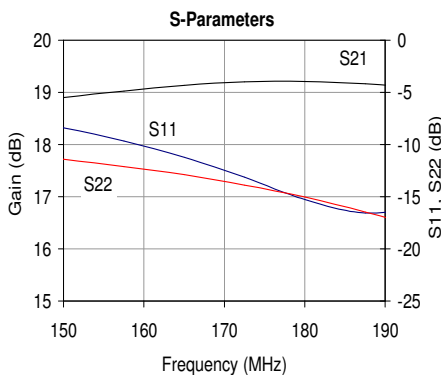
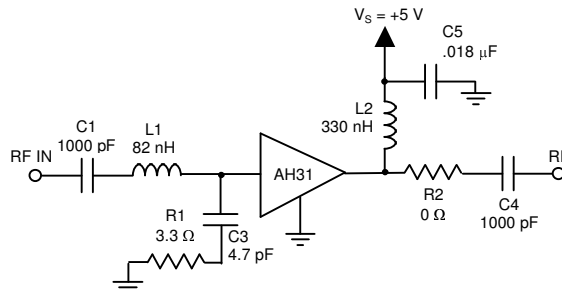



Application Circuit: 220 – 260 MHz (AH31-PCB240)

Typical Performance

Frequency	240 MHz
Gain	19.3 dB
S11	-19 dB
S22	-12.5 dB
Output P1dB	+22 dBm
Output IP3	+42 dBm
Noise Figure	2.2 dB
Bias	+5 V @ 150 mA

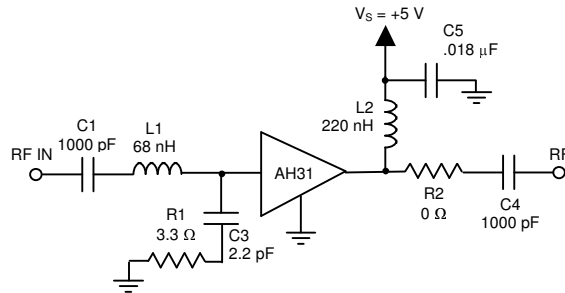

Notes:

1. The amplifier should be connected directly to a +5 V regulator; no dropping resistor is required.
2. If no DC signal is present at the input (pin 1), C1 can be removed. The gate is internally grounded in the amplifier.
3. R2 is used as a placeholder for a different application circuit. It can be removed from the circuit.
4. C2 (from the silkscreen) is not utilized in this application circuit.

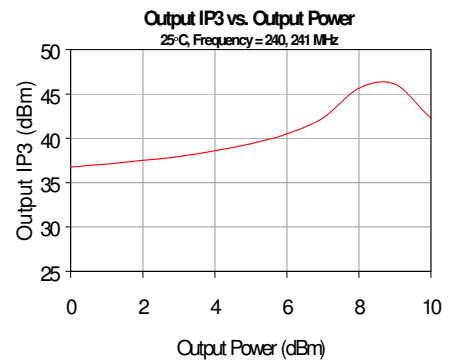
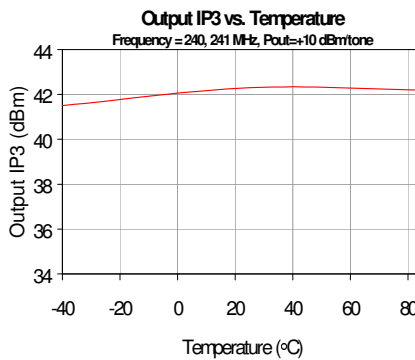
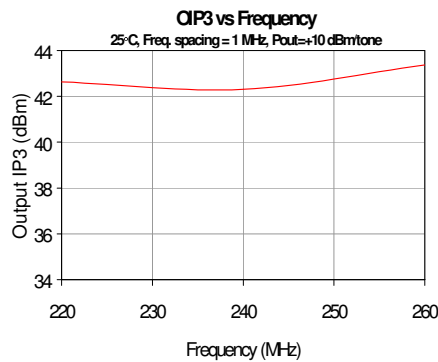
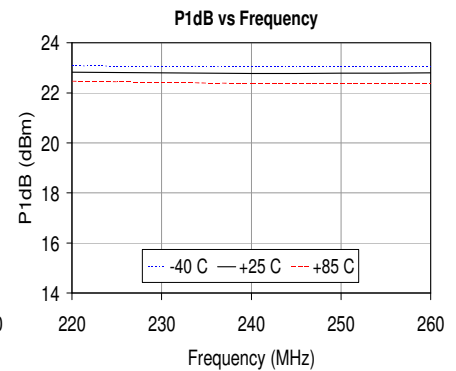
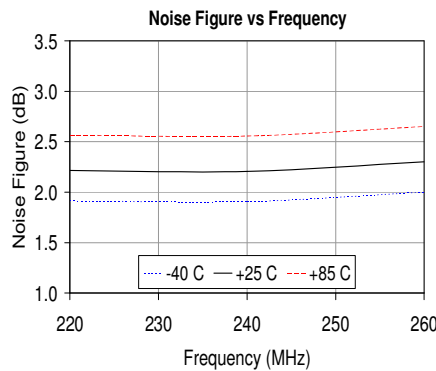
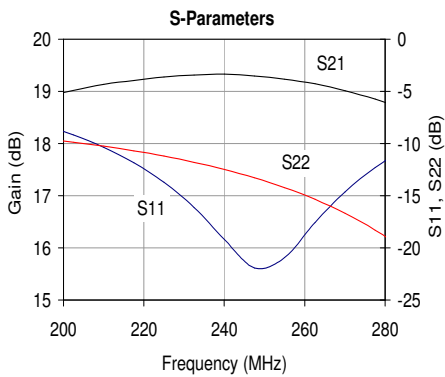



Application Circuit: 450 – 550 MHz (AH31-PCB500)

Typical Performance

Frequency	500 MHz
Gain	18.4 dB
S11	-12.7 dB
S22	-9.2 dB
Output P1dB	+21 dBm
Output IP3	+41 dBm
Noise Figure	1.9 dB
Bias	+5 V @ 150 mA

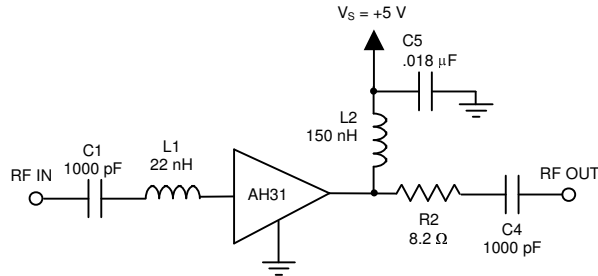

Notes:

1. The amplifier should be connected directly to a +5 V regulator; no dropping resistor is required.
2. If no DC signal is present at the input (pin 1), C1 can be removed. The gate is internally grounded in the amplifier.
3. R1, C2, and C3 (from the silkscreen) are not utilized in this application circuit.

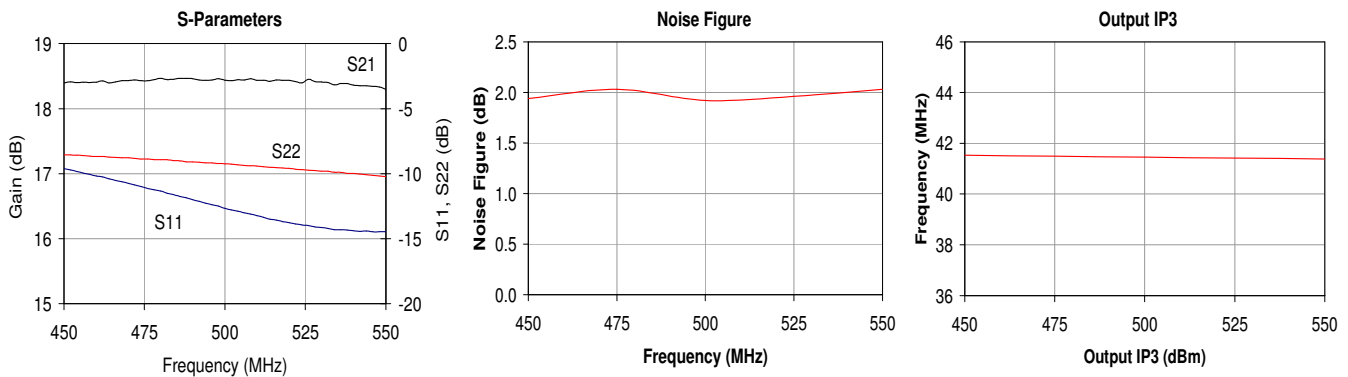

Reference Design: 900 MHz

Typical Performance

Frequency	900 MHz
S21 - Gain	16.6 dB
S11	-14 dB
S22	-9 dB
Output P1dB	+20 dBm
Output IP3	+41 dBm
Noise Figure	2.2 dB
Bias	5 V @ 150 mA

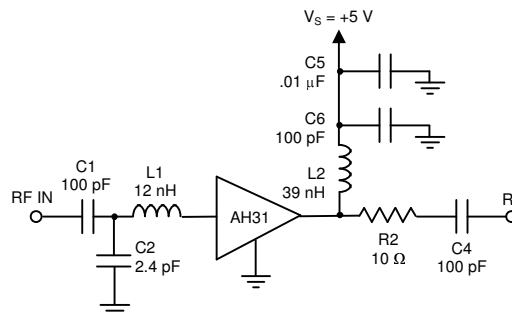

Notes:

1. The amplifier should be connected directly to a +5 V regulator; no dropping resistor is required.
2. If no DC signal is present at the input (pin 1), C1 can be removed. The gate is internally grounded in the amplifier.
3. R1 and C3 (from the silkscreen) are not utilized in this application circuit.

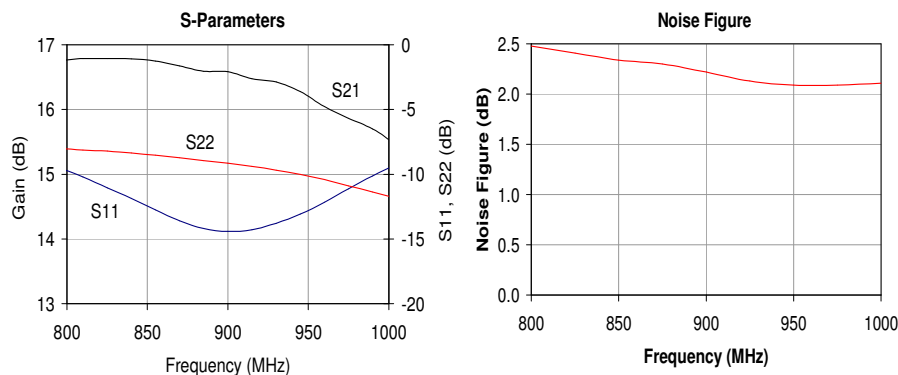

Specifications and information are subject to change without notice



Broader Bandwidth Reference Designs

The AH31 can be designed to achieve good performance over a broader frequency range (around one octave) by using an additional L-C matching network at the input. An equalization R-C network can also be added at the output to slightly flatten out the typical downward slope of the amplifier circuit.

Reference Design: 36 - 56 MHz

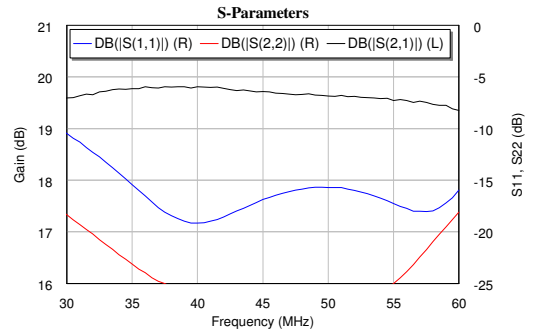
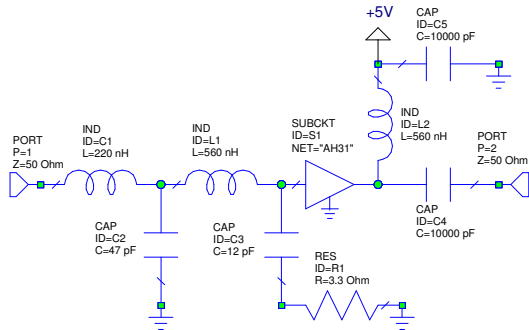

Reference Design: 45 - 90 MHz

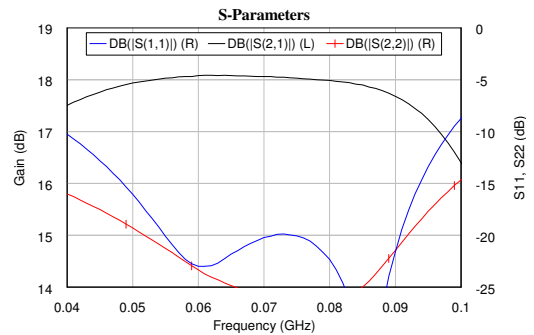
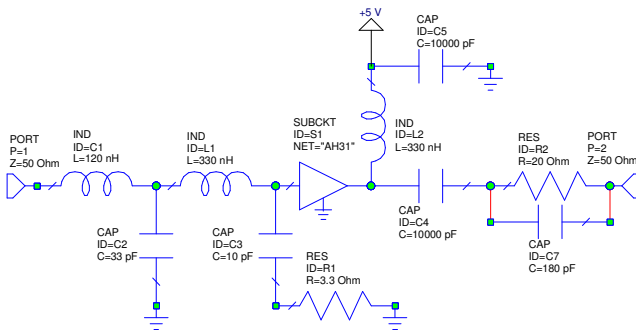

Reference Design: 65 - 165 MHz

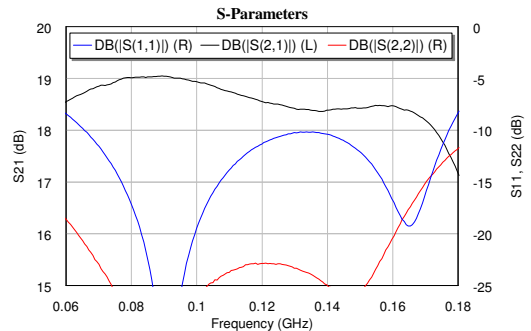
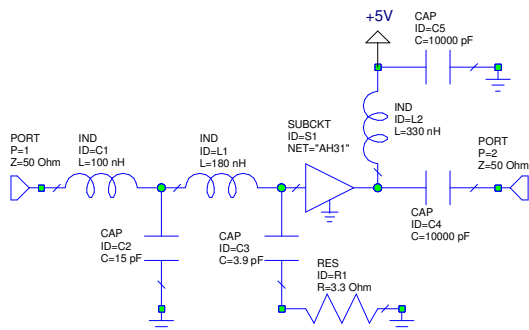

Reference Design: 80 - 200 MHz

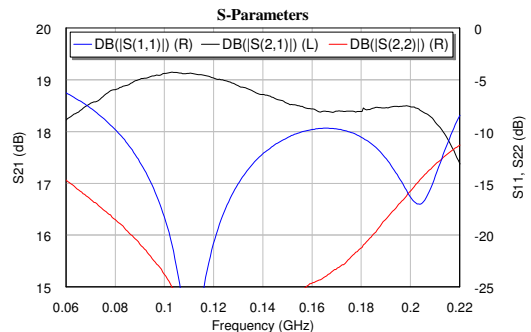
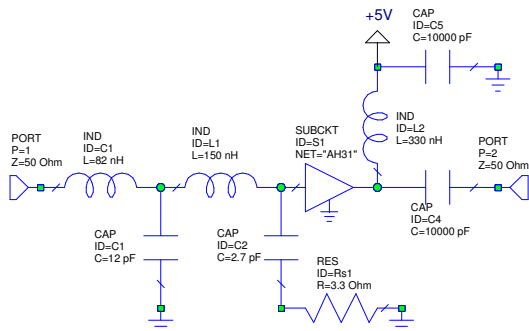

Specifications and information are subject to change without notice



AH31

High Dynamic Range IF Amplifier

The Communications Edge™

Product Information

AH31-G (Green / Lead-free SOT-89 Package) Mechanical Information

This package is lead-free/Green/RoHS-compliant. It is compatible with both lead-free (maximum 260 °C reflow temperature) and leaded (maximum 245 °C reflow temperature) soldering processes. The plating material on the leads is NiPdAu.

Outline Drawing

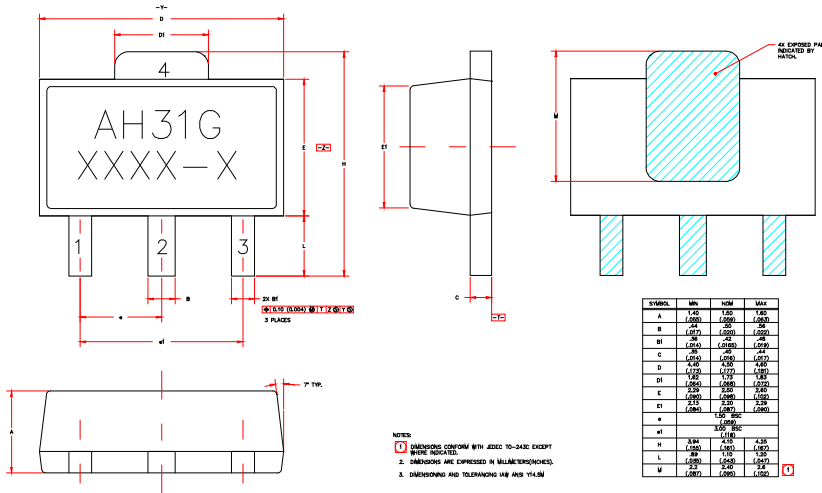

Product Marking

The AH31-G will be marked with an "AH31G" designator. An alphanumeric lot code ("XXXX-X") is also marked below the part designator on the top surface of the package. The obsolete tin-lead package is marked with an "AH31" designator followed by an alphanumeric lot code.

Tape and reel specifications for this part are located on the website in the "Application Notes" section.

MSL / ESD Rating



Caution! ESD sensitive device.

ESD Rating: Class 1B
 Value: Passes ≥ 500V to <1000V
 Test: Human Body Model (HBM)
 Standard: JEDEC Standard JESD22-A114

ESD Rating: Class IV
 Value: Passes ≥ 1000V to <2000V
 Test: Charged Device Model (CDM)
 Standard: JEDEC Standard JESD22-C101

MSL Rating: Level 3 at +260 °C convection reflow
 Standard: JEDEC Standard J-STD-020

Land Pattern

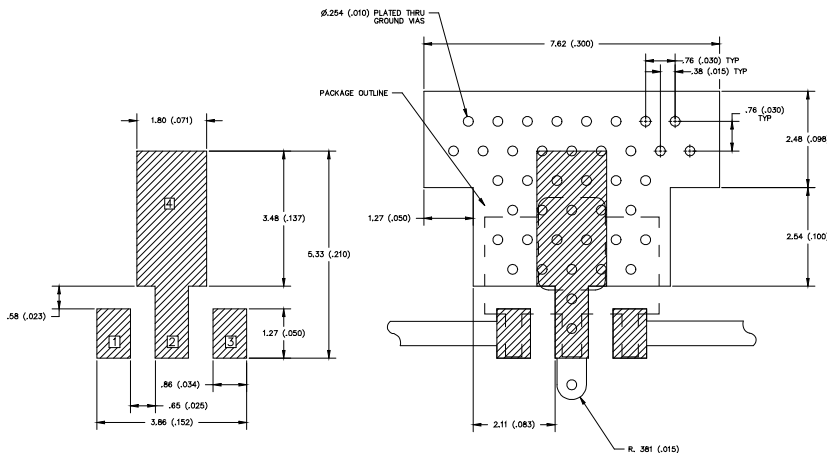

Thermal Specifications

Parameter	Rating
Operating Case Temperature	-40 to +85 °C
Thermal Resistance, Rth ⁽¹⁾	59 °C / W
Junction Temperature, Tj ⁽²⁾	129 °C

- The thermal resistance is referenced from the hottest part of the junction to the ground tab (pin 4).
- This corresponds to the typical biasing condition of +5V, 150 mA at an 85 °C case temperature. A minimum MTTF of 1 million hours is achieved for junction temperatures below 160 °C.

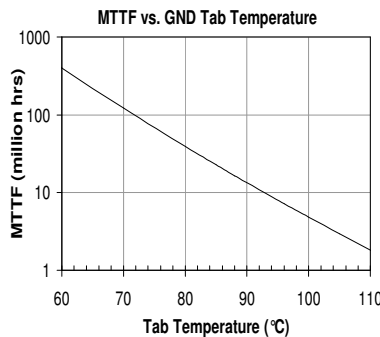

Mounting Config. Notes

- Ground / thermal vias are critical for the proper performance of this device. Vias should use a .35mm (#80 / .0135") diameter drill and have a final plated thru diameter of .25 mm (.010").
- Add as much copper as possible to inner and outer layers near the part to ensure optimal thermal performance.
- Mounting screws can be added near the part to fasten the board to a heatsink. Ensure that the ground / thermal via region contacts the heatsink.
- Do not put solder mask on the backside of the PC board in the region where the board contacts the heatsink.
- RF trace width depends upon the PC board material and construction.
- Use 1 oz. Copper minimum.
- All dimensions are in millimeters (inches). Angles are in degrees.

Specifications and information are subject to change without notice