

Surface Mount

Monolithic Amplifier

DC-8 GHz

Product Features

- InGaP HBT microwave amplifier
- Miniature SOT-89 package
- Internally Matched to 50 Ohms
- Frequency range, DC to 8 GHz
- Output power, 12.2 dBm typ.
- Excellent package for heat dissipation, exposed metal bottom
- Low thermal resistance for high reliability
- Aqueous washable
- Protected by US Patent 6,943,629

Typical Applications

- Cellular
- PCS
- Communication receivers & transmitters

General Description

Gali₁+ (RoHS compliant) is a wideband amplifier offering high dynamic range. Lead finish is SnAgNi. It has repeatable performance from lot to lot, and is enclosed in a SOT-89 package. It uses patented Transient Protected Darlington configuration and is fabricated using InGaP HBT technology. Expected MTTF is 20,000 years at 85°C case temperature. Gali₁+ is designed to be rugged for ESD and supply switch-on transients.

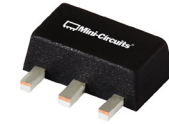

Generic photo used for illustration purposes only

Gali₁+

CASE STYLE: DF782

+RoHS Compliant

The +Suffix identifies RoHS Compliance. See our web site for RoHS Compliance methodologies and qualifications

simplified schematic and pin description

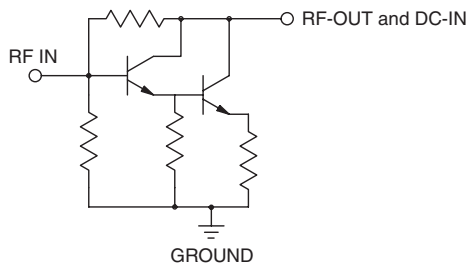

Function	Pin Number	Description
RF IN	1	RF input pin. This pin requires the use of an external DC blocking capacitor chosen for the frequency of operation.
RF-OUT and DC-IN	3	RF output and bias pin. DC voltage is present on this pin; therefore a DC blocking capacitor is necessary for proper operation. An RF choke is needed to feed DC bias without loss of RF signal due to the bias connection, as shown in "Recommended Application Circuit".
GND	2,4	Connections to ground. Use via holes as shown in "Suggested Layout for PCB Design" to reduce ground path inductance for best performance.

Notes

- Performance and quality attributes and conditions not expressly stated in this specification document are intended to be excluded and do not form a part of this specification document.
- Electrical specifications and performance data contained in this specification document are based on Mini-Circuit's applicable established test performance criteria and measurement instructions.
- The parts covered by this specification document are subject to Mini-Circuits standard limited warranty and terms and conditions (collectively, "Standard Terms"); Purchasers of this part are entitled to the rights and benefits contained therein. For a full statement of the Standard Terms and the exclusive rights and remedies thereunder, please visit Mini-Circuits' website at www.minicircuits.com/MCLStore/terms.jsp



Electrical Specifications at 25°C and 40mA, unless noted

Parameter		Min.	Typ.	Max.	Units
Frequency Range*		DC		8	GHz
Gain	f=0.1 GHz	—	12.7	—	dB
	f=1 GHz	—	12.5	—	
	f=2 GHz	9.0	11.8	—	
	f=3 GHz	—	11.3	—	
	f=4 GHz	—	10.5	—	
	f=6 GHz	—	10.5	—	
	f=8 GHz	—	11.0	—	
Input Return Loss	f= DC to 3 GHz		17.5		dB
	f= 3 to 8 GHz		11.5		
Output Return Loss	f= DC to 3 GHz		15.5		dB
	f= 3 to 8 GHz		11		
Output Power @ 1 dB compression	f=2 GHz	10.5	12.2	—	dBm
Output IP3	f=2 GHz		27		dBm
Noise Figure	f=2 GHz		4.5		dB
Recommended Device Operating Current			40		mA
Device Operating Voltage		3.0	3.4	4.1	V
Device Voltage Variation vs. Temperature at 40 mA			-2.8		mV/°C
Device Voltage Variation vs. Current at 25°C			9.4		mV/mA
Thermal Resistance, junction-to-case ¹			108		°C/W

*Guaranteed specification DC-8 GHz. Low frequency cut off determined by external coupling capacitors.

Absolute Maximum Ratings

Parameter	Ratings
Operating Temperature*	-45°C to 85°C
Storage Temperature	-65°C to 150°C
Operating Current	55mA
Input Power	15dBm

Note: Permanent damage may occur if any of these limits are exceeded.

These ratings are not intended for continuous normal operation.

¹Case is defined as ground leads.

*Based on typical case temperature rise 2°C above ambient.

Notes

- A. Performance and quality attributes and conditions not expressly stated in this specification document are intended to be excluded and do not form a part of this specification document.
- B. Electrical specifications and performance data contained in this specification document are based on Mini-Circuit's applicable established test performance criteria and measurement instructions.
- C. The parts covered by this specification document are subject to Mini-Circuits standard limited warranty and terms and conditions (collectively, "Standard Terms"); Purchasers of this part are entitled to the rights and benefits contained therein. For a full statement of the Standard Terms and the exclusive rights and remedies thereunder, please visit Mini-Circuits' website at www.minicircuits.com/MCLStore/terms.jsp



Product Marking

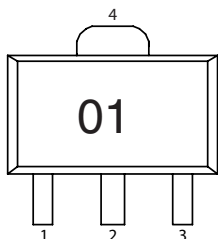

Markings in addition to model number designation may appear for internal quality control purposes.

Additional Detailed Technical Information

Additional information is available on our web site. To access this information enter the model number on our web site home page.

Performance data, graphs, s-parameter data set (.zip file)

Case Style: DF782

Plastic package, exposed paddle, lead finish: Matte-Tin

Tape & Reel: F55

7" reels with 20, 50, 100, 200, 500, 1K devices.

Suggested Layout for PCB Design: PL-019

Evaluation Board: TB-409-1+

Environmental Ratings: ENV08T2

Recommended Application Circuit

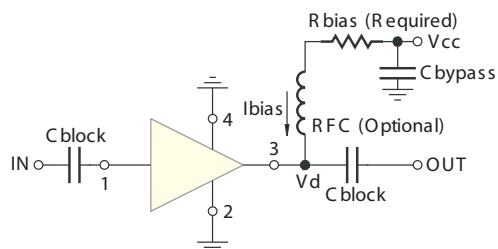

Test Board includes case, connectors, and components (in bold) soldered to PCB

R BIAS	
Vcc	"1%" Res. Values (ohms) for Optimum Biasing
7	90.9
8	113
9	137
10	162
11	187
12	215
13	237
14	261
15	287
16	309
17	332
18	357
19	383
20	412

Notes

- A. Performance and quality attributes and conditions not expressly stated in this specification document are intended to be excluded and do not form a part of this specification document.
- B. Electrical specifications and performance data contained in this specification document are based on Mini-Circuit's applicable established test performance criteria and measurement instructions.
- C. The parts covered by this specification document are subject to Mini-Circuits standard limited warranty and terms and conditions (collectively, "Standard Terms"); Purchasers of this part are entitled to the rights and benefits contained therein. For a full statement of the Standard Terms and the exclusive rights and remedies thereunder, please visit Mini-Circuits' website at www.minicircuits.com/MCLStore/terms.jsp



ESD Rating

Human Body Model (HBM): Class 1B (500 v to < 1000 v) in accordance with ANSI/ESD STM 5.1 - 2001

Machine Model (MM): Class M1 (< 100 v) in accordance with ANSI/ESD STM 5.2 - 1999

MSL Rating

Moisture Sensitivity: MSL1 in accordance with IPC/JEDECJ-STD-020C

No.	Test Required	Condition	Standard	Quantity
1	Visual Inspection	Low Power Microscope Magnification 40x	MIP-IN-0003 (MCT spec)	45 units
2	Electrical Test	Room Temperature	SCD (MCL spec)	45 units
3	SAM Analysis	Less than 10% growth in term of delamination	J-Std-020C (Jedec Standard)	45 units
4	Moisture Sensitivity Level 1	Bake at 125°C for 24 hours Soak at 85°C/85%RH for 168 hours Reflow 3 cycles at 260°C peak	J-Std-020C (Jedec Standard)	45 units

MSL Test Flow Chart



Notes

- A. Performance and quality attributes and conditions not expressly stated in this specification document are intended to be excluded and do not form a part of this specification document.
- B. Electrical specifications and performance data contained in this specification document are based on Mini-Circuit's applicable established test performance criteria and measurement instructions.
- C. The parts covered by this specification document are subject to Mini-Circuits standard limited warranty and terms and conditions (collectively, "Standard Terms"); Purchasers of this part are entitled to the rights and benefits contained therein. For a full statement of the Standard Terms and the exclusive rights and remedies thereunder, please visit Mini-Circuits' website at www.minicircuits.com/MCLStore/terms.jsp



MMIC Amplifier

GALI-1+

Typical Performance Data

**NOTE: Use PDF Bookmarks to view DATA at required conditions
or to view GRAPHS.**

Definitions:

Input Return Loss = -S11 (dB)

Gain(Power Gain) = S21 (dB)

Reverse Isolation = -S12 (dB)

Output Return Loss = -S22 (dB)

TEST CONDITIONS: Icc = 40mA, Vd = 3.41V @Temperature = +25degC

FREQ	Gain	Isolation	Input Return Loss	Output Return Loss	Stability		IP3 Output	1dB Comp. Output	Noise Figure
					K	Delta			
(MHz)	(dB)	(dB)	(dB)	(dB)	K	Delta	(dBm)	(dBm)	(dB)
50	12.42	17.09	36.87	26.18	1.14	0.58	29.36	12.69	4.18
100	12.45	17.04	35.27	26.11	1.14	0.59	28.90	12.59	4.37
200	12.41	17.07	36.28	25.85	1.14	0.58	29.01	12.85	4.16
400	12.32	17.08	34.51	25.90	1.15	0.58	28.33	12.80	4.28
600	12.25	17.11	33.50	25.80	1.16	0.57	27.96	12.65	4.22
800	12.17	17.12	32.05	25.66	1.16	0.56	28.39	12.56	4.31
1000	12.08	17.17	30.55	25.80	1.17	0.56	28.30	12.53	4.27
1200	11.98	17.22	28.95	26.05	1.18	0.55	28.06	12.29	4.29
1400	11.90	17.27	27.39	26.71	1.19	0.54	27.72	12.45	4.40
1600	11.81	17.35	26.01	27.70	1.21	0.53	28.05	12.39	4.35
1800	11.72	17.44	24.86	29.40	1.22	0.52	28.29	12.47	4.37
2000	11.63	17.54	23.37	31.78	1.23	0.50	27.92	12.58	4.15
2200	11.54	17.64	22.13	35.46	1.25	0.49	27.72	12.53	4.16
2400	11.44	17.75	20.92	37.27	1.27	0.48	27.67	12.45	4.42
2600	11.35	17.89	19.89	33.84	1.29	0.47	27.20	12.29	4.46
2800	11.26	17.97	18.83	30.50	1.30	0.46	27.10	12.28	4.44
3000	11.17	18.11	18.01	27.77	1.32	0.45	26.92	12.27	4.28
3200	11.08	18.28	17.25	25.69	1.34	0.44	26.52	12.39	4.34
3400	11.01	18.39	16.74	24.29	1.36	0.43	26.45	12.46	4.55
3600	10.95	18.52	16.23	23.16	1.38	0.43	25.80	12.30	4.59
3800	10.87	18.68	15.92	22.27	1.41	0.42	25.25	11.93	4.68
4000	10.83	18.84	15.62	21.42	1.43	0.41	24.70	11.96	4.55
4200	10.76	18.93	15.55	21.15	1.44	0.40	24.65	12.08	4.48
4400	10.73	19.06	15.48	20.73	1.46	0.40	24.67	12.05	4.56
4600	10.71	19.17	15.55	20.57	1.48	0.39	24.63	11.99	4.81
4800	10.67	19.26	15.72	20.56	1.50	0.39	24.33	12.09	4.90
5000	10.72	19.43	15.66	20.15	1.51	0.38	23.98	11.99	4.80
5200	10.70	19.49	15.98	20.36	1.52	0.38	23.69	11.63	4.71
5400	10.75	19.60	16.17	20.08	1.53	0.38	23.46	11.31	4.58
5600	10.81	19.66	16.38	20.15	1.53	0.37	23.09	10.74	4.74
5800	10.85	19.64	16.88	20.52	1.53	0.37	22.44	11.05	4.79
6000	10.94	19.68	17.32	20.70	1.52	0.38	21.57	10.84	4.86
6200	11.04	19.65	18.12	21.04	1.51	0.38	21.15	10.77	4.59
6400	11.19	19.68	18.70	20.97	1.49	0.38	20.69	10.49	4.61
6600	11.26	19.68	20.05	21.63	1.49	0.38	20.29	10.31	4.76
6800	11.42	19.49	22.28	20.77	1.45	0.40	19.76	9.98	4.81
7000	11.52	19.52	23.62	20.38	1.44	0.40	19.25	9.87	4.91
7200	11.65	19.32	26.10	18.68	1.40	0.42	19.13	9.49	4.84
7500	11.76	19.05	24.15	16.41	1.35	0.44	18.88	9.49	4.94
8000	11.55	18.80	16.86	13.46	1.32	0.46	17.28	8.46	4.93

REV. X1
GALI-1+
110601
Page 1 of 11



IF/RF MICROWAVE COMPONENTS • ISO 9001 ISO 14001 AS 9100 CERTIFIED • RoHS compliant
P.O. Box 350166, Brooklyn, New York 11235-0003 (718) 934-4500 Fax (718) 332-4661



The Design Engineers Search Engine finds the model you need, Instantly • For detailed performance specs & shopping online see



MMIC Amplifier

GALI-1+

Typical Performance Data

Definitions:

Input Return Loss = -S11 (dB)

Gain(Power Gain) = S21 (dB)

Reverse Isolation = -S12 (dB)

Output Return Loss = -S22 (dB)

TEST CONDITIONS: Icc = 32mA, Vd = 3.33V @Temperature = +25degC

FREQ	Gain	Isolation	Input Return Loss	Output Return Loss	Stability		IP3 Output	1dB Comp. Output	Noise Figure
					K	Delta			
(MHz)	(dB)	(dB)	(dB)	(dB)	K	Delta	(dBm)	(dBm)	(dB)
50	12.21	16.87	29.62	29.85	1.14	0.58	25.38	9.68	4.16
100	12.23	16.84	29.84	29.78	1.14	0.59	25.06	9.69	4.31
200	12.18	16.87	30.45	29.42	1.15	0.58	25.11	10.14	4.14
400	12.11	16.91	29.38	29.83	1.15	0.57	24.60	9.95	4.24
600	12.05	16.94	29.16	29.20	1.16	0.57	24.37	9.86	4.20
800	11.96	16.96	28.29	29.22	1.17	0.56	25.00	9.80	4.28
1000	11.86	17.01	27.53	29.11	1.18	0.55	25.00	9.67	4.24
1200	11.77	17.05	26.40	29.55	1.19	0.54	24.68	9.52	4.30
1400	11.70	17.13	25.13	30.57	1.20	0.53	24.39	9.82	4.37
1600	11.60	17.20	24.08	31.86	1.21	0.52	24.69	9.66	4.33
1800	11.53	17.29	23.13	33.74	1.22	0.51	25.10	9.81	4.32
2000	11.43	17.38	21.86	35.92	1.24	0.50	24.84	9.93	4.11
2200	11.35	17.47	20.71	35.88	1.25	0.49	24.67	9.84	4.10
2400	11.25	17.59	19.65	32.44	1.27	0.48	24.90	9.71	4.39
2600	11.15	17.71	18.75	29.38	1.29	0.47	24.45	9.51	4.44
2800	11.07	17.84	17.73	26.96	1.30	0.46	24.51	9.54	4.40
3000	10.99	17.95	17.02	25.20	1.32	0.45	24.55	9.65	4.26
3200	10.90	18.13	16.29	23.51	1.34	0.44	24.52	9.90	4.32
3400	10.84	18.24	15.86	22.54	1.36	0.44	24.51	10.00	4.54
3600	10.76	18.34	15.39	21.65	1.37	0.43	24.12	9.79	4.54
3800	10.69	18.50	15.07	20.86	1.40	0.42	23.49	9.34	4.66
4000	10.65	18.64	14.84	20.25	1.42	0.42	23.09	9.51	4.52
4200	10.60	18.77	14.73	19.97	1.44	0.41	23.13	9.81	4.42
4400	10.57	18.89	14.68	19.67	1.46	0.40	23.25	9.65	4.50
4600	10.54	19.00	14.73	19.52	1.47	0.40	23.08	9.70	4.79
4800	10.51	19.09	14.89	19.57	1.49	0.39	22.78	9.98	4.87
5000	10.56	19.26	14.80	19.25	1.50	0.39	22.71	10.10	4.76
5200	10.56	19.31	15.06	19.44	1.51	0.38	22.61	9.67	4.67
5400	10.60	19.39	15.27	19.33	1.52	0.38	22.49	9.07	4.53
5600	10.65	19.44	15.43	19.40	1.52	0.38	22.33	8.57	4.70
5800	10.72	19.43	15.84	19.81	1.51	0.38	21.75	9.25	4.75
6000	10.80	19.49	16.26	20.09	1.51	0.38	21.08	9.20	4.79
6200	10.91	19.45	16.96	20.47	1.49	0.38	20.67	9.43	4.54
6400	11.05	19.47	17.48	20.51	1.48	0.39	20.28	9.31	4.53
6600	11.13	19.47	18.53	21.23	1.48	0.39	19.82	9.16	4.70
6800	11.28	19.28	20.33	20.65	1.44	0.40	19.31	8.88	4.74
7000	11.37	19.29	21.28	20.35	1.43	0.41	18.84	8.73	4.82
7200	11.50	19.10	23.08	18.82	1.39	0.42	18.72	8.36	4.79
7500	11.58	18.84	22.64	16.60	1.35	0.44	18.43	8.39	4.89
8000	11.34	18.57	16.63	13.70	1.32	0.46	16.98	7.50	4.86

REV. X1
GALI-1+
110601
Page 2 of 11



IF/RF MICROWAVE COMPONENTS • ISO 9001 ISO 14001 AS 9100 CERTIFIED • RoHS compliant
P.O. Box 350166, Brooklyn, New York 11235-0003 (718) 934-4500 Fax (718) 332-4661



The Design Engineers Search Engine finds the model you need, Instantly • For detailed performance specs & shopping online see



Typical Performance Data

Definitions:

Input Return Loss = -S11 (dB)

Gain(Power Gain) = S21 (dB)

Reverse Isolation = -S12 (dB)

Output Return Loss = -S22 (dB)

TEST CONDITIONS: Icc = 48mA, Vd = 3.48V @Temperature = +25degC

FREQ	Gain	Isolation	Input Return Loss	Output Return Loss	Stability		IP3 Output	1dB Comp. Output	Noise Figure
					K	Delta			
(MHz)	(dB)	(dB)	(dB)	(dB)	K	Delta	(dBm)	(dBm)	(dB)
50	12.55	17.12	41.08	24.65	1.14	0.59	32.00	14.21	4.22
100	12.57	17.12	42.26	24.36	1.14	0.59	31.77	14.20	4.41
200	12.53	17.16	43.72	24.21	1.14	0.59	31.48	14.30	4.18
400	12.45	17.16	39.14	24.40	1.15	0.58	30.82	14.28	4.30
600	12.37	17.19	36.47	24.20	1.15	0.57	30.17	14.14	4.25
800	12.29	17.23	34.25	24.16	1.16	0.57	30.29	13.97	4.33
1000	12.20	17.27	32.21	24.23	1.17	0.56	30.07	13.95	4.31
1200	12.10	17.32	30.42	24.54	1.18	0.55	29.97	13.71	4.32
1400	12.01	17.37	28.62	25.15	1.19	0.54	29.53	13.77	4.42
1600	11.92	17.46	27.15	26.02	1.20	0.53	29.85	13.75	4.40
1800	11.83	17.54	25.85	27.46	1.22	0.52	29.65	13.82	4.39
2000	11.74	17.61	24.27	29.48	1.23	0.51	29.31	13.96	4.19
2200	11.65	17.73	23.01	32.89	1.25	0.50	29.01	13.90	4.19
2400	11.55	17.84	21.69	37.39	1.27	0.48	28.84	13.79	4.45
2600	11.45	17.96	20.62	37.38	1.28	0.47	28.21	13.73	4.53
2800	11.36	18.07	19.50	33.05	1.30	0.46	27.96	13.75	4.48
3000	11.27	18.20	18.64	29.76	1.32	0.45	27.77	13.74	4.35
3200	11.18	18.37	17.87	27.03	1.35	0.44	27.20	13.70	4.41
3400	11.11	18.48	17.33	25.52	1.36	0.43	26.98	13.71	4.59
3600	11.04	18.61	16.84	24.18	1.38	0.43	26.51	13.57	4.64
3800	10.96	18.79	16.51	23.14	1.41	0.42	25.87	13.23	4.72
4000	10.91	18.94	16.17	22.20	1.43	0.41	25.24	13.12	4.60
4200	10.85	19.03	16.11	21.85	1.45	0.40	25.10	13.11	4.53
4400	10.81	19.16	16.04	21.39	1.47	0.40	25.13	13.09	4.60
4600	10.79	19.28	16.13	21.17	1.49	0.39	25.09	13.08	4.86
4800	10.75	19.37	16.30	21.15	1.51	0.38	24.71	13.11	4.94
5000	10.80	19.54	16.26	20.67	1.52	0.38	24.47	12.91	4.84
5200	10.78	19.62	16.58	20.87	1.53	0.37	24.03	12.61	4.75
5400	10.83	19.71	16.80	20.57	1.54	0.37	23.79	12.34	4.63
5600	10.88	19.76	17.07	20.55	1.54	0.37	23.38	11.78	4.80
5800	10.93	19.78	17.60	20.92	1.54	0.37	22.67	11.90	4.86
6000	11.01	19.80	18.08	21.11	1.53	0.37	21.79	11.59	4.90
6200	11.11	19.77	18.97	21.38	1.52	0.38	21.33	11.44	4.65
6400	11.26	19.81	19.69	21.28	1.50	0.38	20.91	11.13	4.66
6600	11.34	19.80	21.15	21.87	1.50	0.38	20.49	10.93	4.83
6800	11.49	19.62	23.86	20.91	1.46	0.39	20.02	10.61	4.88
7000	11.59	19.65	25.63	20.47	1.45	0.40	19.50	10.46	4.98
7200	11.73	19.45	28.50	18.70	1.41	0.41	19.33	10.13	4.92
7500	11.84	19.18	24.68	16.38	1.36	0.44	19.07	10.11	5.01
8000	11.68	18.91	16.85	13.40	1.32	0.47	17.42	9.04	5.01

MMIC Amplifier

GALI-1+

Typical Performance Data

Definitions:

Input Return Loss = -S11 (dB)

Gain(Power Gain) = S21 (dB)

Reverse Isolation = -S12 (dB)

Output Return Loss = -S22 (dB)

TEST CONDITIONS: Icc = 40mA, Vd = 3.57V @Temperature = -45degC

FREQ	Gain	Isolation	Input Return Loss	Output Return Loss	Stability		IP3 Output	1dB Comp. Output	Noise Figure
					K	Delta			
(MHz)	(dB)	(dB)	(dB)	(dB)	K	Delta	(dBm)	(dBm)	(dB)
50	12.57	17.02	36.49	25.86	1.13	0.60	29.94	12.62	3.52
100	12.60	17.11	32.93	26.72	1.13	0.59	29.61	12.49	3.68
200	12.56	17.12	32.24	27.26	1.14	0.59	29.74	12.74	3.50
400	12.49	17.13	37.25	24.77	1.14	0.58	29.11	12.71	3.55
600	12.43	17.18	36.14	24.67	1.15	0.58	28.83	12.65	3.51
800	12.35	17.19	33.60	24.69	1.16	0.57	29.25	12.58	3.58
1000	12.26	17.21	31.90	25.14	1.16	0.56	29.28	12.46	3.54
1200	12.18	17.25	30.60	24.94	1.17	0.56	29.08	12.25	3.56
1400	12.10	17.31	28.48	25.18	1.18	0.55	28.65	12.50	3.63
1600	12.00	17.37	26.76	26.26	1.19	0.54	29.12	12.38	3.62
1800	11.93	17.46	25.70	27.99	1.20	0.53	29.26	12.52	3.61
2000	11.84	17.54	24.81	29.42	1.22	0.52	28.99	12.68	3.39
2200	11.76	17.62	23.74	32.65	1.23	0.51	28.81	12.63	3.38
2400	11.66	17.75	22.34	36.83	1.25	0.50	28.75	12.54	3.64
2600	11.57	17.85	21.03	38.48	1.26	0.49	28.50	12.41	3.67
2800	11.49	17.93	19.79	34.16	1.28	0.48	28.28	12.34	3.64
3000	11.40	18.07	18.78	29.78	1.30	0.47	28.19	12.32	3.53
3200	11.32	18.22	17.86	27.12	1.32	0.46	27.90	12.51	3.57
3400	11.25	18.34	17.62	26.13	1.33	0.45	27.93	12.61	3.77
3600	11.18	18.45	17.12	24.37	1.35	0.44	27.41	12.48	3.75
3800	11.11	18.63	16.99	23.53	1.38	0.43	26.60	12.13	3.85
4000	11.05	18.76	16.62	22.37	1.40	0.42	26.08	12.14	3.74
4200	11.02	18.82	16.63	22.39	1.41	0.42	26.12	12.32	3.69
4400	10.97	18.93	16.36	21.81	1.43	0.41	26.22	12.24	3.75
4600	10.94	19.07	16.35	21.39	1.44	0.41	26.16	12.13	4.00
4800	10.90	19.18	16.15	20.92	1.46	0.40	25.88	12.36	3.99
5000	10.94	19.34	16.30	20.82	1.48	0.39	25.66	12.44	3.97
5200	10.92	19.40	16.54	20.78	1.49	0.39	25.38	12.22	3.90
5400	10.96	19.51	16.61	19.82	1.50	0.39	25.21	11.86	3.78
5600	11.03	19.56	17.64	20.30	1.50	0.38	24.97	11.33	3.88
5800	11.09	19.56	18.31	21.41	1.49	0.39	24.39	11.54	3.95
6000	11.16	19.57	19.19	20.56	1.49	0.39	23.58	11.46	4.00
6200	11.27	19.57	20.13	20.70	1.47	0.39	23.20	11.51	3.81
6400	11.41	19.57	21.55	20.59	1.46	0.39	22.79	11.36	3.85
6600	11.51	19.57	23.17	20.86	1.45	0.40	22.29	11.13	3.96
6800	11.65	19.45	24.81	19.87	1.42	0.41	21.86	10.83	3.98
7000	11.77	19.43	25.63	18.71	1.40	0.42	21.34	10.64	4.04
7200	11.92	19.28	26.45	17.56	1.36	0.43	20.91	10.40	4.01
7500	12.08	19.02	22.56	15.25	1.31	0.46	20.66	10.45	4.08
8000	12.04	18.73	16.84	13.13	1.27	0.49	19.12	9.59	4.13

REV. X1
GALI-1+
110601
Page 4 of 11



IF/RF MICROWAVE COMPONENTS • ISO 9001 ISO 14001 AS 9100 CERTIFIED • RoHS compliant
P.O. Box 350166, Brooklyn, New York 11235-0003 (718) 934-4500 Fax (718) 332-4661



The Design Engineers Search Engine finds the model you need, Instantly • For detailed performance specs & shopping online see



MMIC Amplifier

GALI-1+

Typical Performance Data

Definitions:

Input Return Loss = -S11 (dB)

Gain(Power Gain) = S21 (dB)

Reverse Isolation = -S12 (dB)

Output Return Loss = -S22 (dB)

TEST CONDITIONS: Icc = 32mA, Vd = 3.49V @Temperature = -45degC

FREQ	Gain	Isolation	Input Return Loss	Output Return Loss	Stability		IP3 Output	1dB Comp. Output	Noise Figure
					K	Delta			
(MHz)	(dB)	(dB)	(dB)	(dB)	K	Delta	(dBm)	(dBm)	(dB)
50	12.39	16.95	30.25	29.18	1.14	0.59	25.94	9.56	3.50
100	12.41	16.97	28.55	30.30	1.14	0.59	25.61	9.35	3.63
200	12.37	16.97	28.51	31.07	1.14	0.59	25.56	9.78	3.44
400	12.31	16.99	31.79	27.31	1.15	0.58	25.27	9.67	3.55
600	12.24	17.02	31.30	27.24	1.15	0.58	25.11	9.63	3.50
800	12.17	17.04	30.12	27.06	1.16	0.57	25.64	9.55	3.59
1000	12.08	17.07	28.86	27.88	1.17	0.56	25.67	9.43	3.52
1200	12.00	17.11	28.42	27.39	1.17	0.55	25.46	9.26	3.54
1400	11.93	17.18	26.71	27.65	1.18	0.55	25.17	9.61	3.63
1600	11.84	17.24	25.17	29.03	1.19	0.54	25.43	9.41	3.59
1800	11.76	17.31	24.09	31.62	1.20	0.53	25.78	9.55	3.54
2000	11.68	17.39	23.31	33.45	1.22	0.52	25.63	9.75	3.35
2200	11.60	17.49	22.39	36.71	1.23	0.51	25.55	9.70	3.34
2400	11.49	17.58	21.11	38.55	1.25	0.50	25.69	9.64	3.60
2600	11.41	17.70	19.90	32.54	1.26	0.49	25.13	9.39	3.63
2800	11.33	17.82	18.83	30.03	1.28	0.48	25.22	9.40	3.62
3000	11.24	17.92	17.81	26.89	1.29	0.47	25.34	9.48	3.48
3200	11.17	18.09	17.01	25.13	1.32	0.46	25.50	9.70	3.55
3400	11.09	18.19	16.72	24.24	1.33	0.45	25.64	9.91	3.75
3600	11.04	18.32	16.29	22.87	1.35	0.44	25.22	9.82	3.71
3800	10.97	18.47	16.17	22.27	1.37	0.43	24.49	9.37	3.81
4000	10.92	18.60	15.83	21.20	1.39	0.43	24.12	9.46	3.71
4200	10.88	18.68	15.84	21.35	1.40	0.42	24.27	9.68	3.65
4400	10.83	18.79	15.58	20.80	1.42	0.42	24.28	9.62	3.69
4600	10.82	18.95	15.60	20.49	1.44	0.41	24.17	9.51	3.97
4800	10.76	19.02	15.38	20.07	1.45	0.40	23.90	9.97	4.00
5000	10.83	19.19	15.55	20.08	1.47	0.40	23.87	10.30	3.95
5200	10.80	19.24	15.73	20.03	1.48	0.39	23.84	10.06	3.89
5400	10.83	19.35	15.79	19.17	1.49	0.39	23.83	9.47	3.75
5600	10.91	19.39	16.75	19.74	1.49	0.39	23.83	8.85	3.87
5800	10.98	19.39	17.30	20.78	1.48	0.39	23.34	9.43	3.92
6000	11.05	19.40	18.09	20.00	1.48	0.39	22.65	9.58	3.98
6200	11.16	19.40	18.86	20.28	1.46	0.39	22.38	9.87	3.76
6400	11.32	19.39	20.01	20.27	1.45	0.40	21.99	10.04	3.80
6600	11.41	19.40	21.30	20.66	1.44	0.40	21.59	9.92	3.92
6800	11.54	19.27	22.46	19.74	1.41	0.42	21.07	9.75	3.92
7000	11.68	19.27	23.21	18.69	1.39	0.42	20.58	9.53	3.99
7200	11.82	19.11	24.11	17.62	1.36	0.44	20.31	9.25	3.96
7500	11.97	18.83	21.98	15.38	1.30	0.47	20.17	9.31	4.06
8000	11.90	18.55	16.81	13.29	1.27	0.50	18.58	8.49	4.06

REV. X1
GALI-1+
110601
Page 5 of 11



IF/RF MICROWAVE COMPONENTS • ISO 9001 ISO 14001 AS 9100 CERTIFIED • RoHS compliant
P.O. Box 350166, Brooklyn, New York 11235-0003 (718) 934-4500 Fax (718) 332-4661



The Design Engineers Search Engine finds the model you need, Instantly • For detailed performance specs & shopping online see



Typical Performance Data

Definitions:

Input Return Loss = -S11 (dB)

Gain(Power Gain) = S21 (dB)

Reverse Isolation = -S12 (dB)

Output Return Loss = -S22 (dB)

TEST CONDITIONS: I_{cc} = 48mA, V_d = 3.64V @Temperature = -45degC

FREQ	Gain	Isolation	Input Return Loss	Output Return Loss	Stability		IP3 Output	1dB Comp. Output	Noise Figure
					K	Delta			
(MHz)	(dB)	(dB)	(dB)	(dB)	K	Delta	(dBm)	(dBm)	(dB)
50	12.68	17.15	41.78	24.48	1.13	0.60	32.39	14.27	3.54
100	12.70	17.16	35.95	25.29	1.13	0.60	32.40	14.29	3.70
200	12.66	17.20	35.12	25.65	1.14	0.59	32.27	14.44	3.53
400	12.59	17.23	42.74	23.54	1.14	0.59	31.72	14.44	3.59
600	12.53	17.22	38.82	23.51	1.15	0.58	31.02	14.32	3.54
800	12.45	17.27	35.34	23.60	1.15	0.57	31.25	14.20	3.63
1000	12.37	17.29	33.57	23.99	1.16	0.57	31.22	14.16	3.57
1200	12.27	17.33	31.59	23.78	1.17	0.56	31.04	13.98	3.59
1400	12.19	17.39	29.27	24.06	1.18	0.55	30.63	14.06	3.65
1600	12.10	17.46	27.57	24.92	1.19	0.54	31.01	14.02	3.63
1800	12.02	17.53	26.58	26.44	1.20	0.53	30.87	14.07	3.63
2000	11.93	17.60	25.63	27.62	1.21	0.52	30.56	14.24	3.43
2200	11.85	17.72	24.57	30.40	1.23	0.51	30.40	14.23	3.41
2400	11.75	17.80	23.10	34.00	1.25	0.50	30.02	14.15	3.66
2600	11.66	17.91	21.68	41.41	1.26	0.49	29.74	14.08	3.70
2800	11.57	18.03	20.44	38.00	1.28	0.48	29.61	14.06	3.68
3000	11.48	18.14	19.36	31.84	1.30	0.47	29.34	14.05	3.55
3200	11.39	18.31	18.42	28.54	1.32	0.45	28.79	14.07	3.61
3400	11.33	18.40	18.13	27.40	1.34	0.45	28.60	14.09	3.80
3600	11.26	18.54	17.60	25.37	1.35	0.44	28.09	14.01	3.78
3800	11.18	18.68	17.55	24.35	1.38	0.43	27.53	13.76	3.90
4000	11.13	18.82	17.11	23.12	1.40	0.42	26.94	13.66	3.79
4200	11.08	18.92	17.17	23.11	1.42	0.42	26.88	13.70	3.72
4400	11.03	19.04	16.92	22.41	1.43	0.41	26.90	13.66	3.78
4600	11.00	19.17	16.90	21.94	1.45	0.40	26.81	13.62	4.03
4800	10.95	19.26	16.71	21.40	1.47	0.40	26.74	13.68	4.05
5000	11.01	19.43	16.84	21.30	1.48	0.39	26.35	13.62	4.03
5200	10.97	19.49	17.16	21.20	1.50	0.39	26.03	13.41	3.96
5400	11.01	19.61	17.18	20.15	1.50	0.38	25.78	13.19	3.83
5600	11.08	19.65	18.31	20.62	1.51	0.38	25.35	12.63	3.93
5800	11.13	19.66	19.10	21.76	1.50	0.38	24.85	12.69	3.97
6000	11.21	19.67	20.02	20.84	1.49	0.38	23.93	12.44	4.04
6200	11.31	19.67	21.14	20.93	1.48	0.39	23.60	12.32	3.85
6400	11.46	19.69	22.65	20.77	1.47	0.39	23.11	12.12	3.89
6600	11.56	19.68	24.90	21.00	1.46	0.39	22.69	11.87	4.03
6800	11.69	19.56	26.79	19.96	1.43	0.41	22.23	11.58	4.02
7000	11.82	19.56	27.86	18.77	1.41	0.41	21.71	11.35	4.09
7200	11.96	19.40	28.04	17.57	1.37	0.43	21.28	11.15	4.07
7500	12.13	19.13	22.58	15.23	1.32	0.46	21.10	11.14	4.16
8000	12.12	18.84	16.72	13.09	1.27	0.49	19.47	10.26	4.20

MMIC Amplifier

GALI-1+

Typical Performance Data

Definitions:

Input Return Loss = -S11 (dB)

Gain(Power Gain) = S21 (dB)

Reverse Isolation = -S12 (dB)

Output Return Loss = -S22 (dB)

TEST CONDITIONS: Icc = 40mA, Vd = 3.21V @Temperature = +85degC

FREQ	Gain	Isolation	Input Return Loss	Output Return Loss	Stability		IP3 Output	1dB Comp. Output	Noise Figure
					K	Delta			
(MHz)	(dB)	(dB)	(dB)	(dB)	K	Delta	(dBm)	(dBm)	(dB)
50	12.29	16.97	34.88	26.79	1.15	0.58	28.78	12.36	4.72
100	12.31	16.93	38.44	25.48	1.14	0.59	28.53	12.42	4.90
200	12.27	16.99	46.00	24.32	1.15	0.58	28.61	12.63	4.66
400	12.19	17.00	33.67	26.34	1.15	0.57	27.89	12.52	4.80
600	12.11	17.04	31.71	26.59	1.16	0.57	27.38	12.43	4.75
800	12.02	17.06	29.30	27.42	1.17	0.56	27.80	12.24	4.85
1000	11.92	17.12	27.94	28.11	1.18	0.55	27.76	12.24	4.79
1200	11.83	17.18	26.70	28.93	1.19	0.54	27.40	12.01	4.85
1400	11.74	17.24	25.66	29.35	1.20	0.53	26.93	12.15	4.97
1600	11.65	17.33	24.76	30.33	1.22	0.52	27.44	12.09	4.93
1800	11.56	17.41	23.91	31.30	1.23	0.51	27.43	12.18	4.93
2000	11.47	17.50	22.71	33.06	1.24	0.50	27.11	12.27	4.72
2200	11.38	17.62	21.55	34.66	1.26	0.49	26.91	12.21	4.74
2400	11.27	17.73	20.25	33.72	1.28	0.48	26.76	12.11	5.03
2600	11.18	17.87	19.20	31.16	1.30	0.46	26.14	12.02	5.07
2800	11.09	18.01	18.17	28.68	1.32	0.45	26.08	12.04	5.04
3000	11.00	18.12	17.24	26.38	1.34	0.44	25.86	12.03	4.90
3200	10.90	18.30	16.42	24.32	1.36	0.43	25.30	12.06	4.97
3400	10.82	18.43	15.75	22.86	1.38	0.43	25.15	12.08	5.20
3600	10.76	18.57	15.25	21.59	1.40	0.42	24.58	11.78	5.22
3800	10.67	18.74	14.86	20.80	1.43	0.41	23.89	11.34	5.30
4000	10.63	18.90	14.58	20.04	1.45	0.40	23.40	11.46	5.18
4200	10.58	19.00	14.55	19.88	1.47	0.40	23.43	11.54	5.11
4400	10.54	19.13	14.58	19.76	1.49	0.39	23.41	11.48	5.20
4600	10.54	19.24	14.79	19.79	1.51	0.39	23.16	11.42	5.49
4800	10.50	19.31	15.00	19.93	1.52	0.38	22.84	11.38	5.58
5000	10.56	19.51	14.98	19.72	1.54	0.38	22.44	11.14	5.45
5200	10.55	19.56	15.18	20.20	1.55	0.37	21.95	10.70	5.34
5400	10.59	19.67	15.24	19.95	1.56	0.37	21.67	10.28	5.24
5600	10.64	19.72	15.23	19.84	1.56	0.37	21.25	9.83	5.41
5800	10.69	19.72	15.37	20.37	1.55	0.37	20.51	10.14	5.49
6000	10.76	19.72	15.68	20.89	1.55	0.37	19.69	9.89	5.49
6200	10.86	19.71	16.19	21.22	1.53	0.37	19.18	9.66	5.26
6400	11.00	19.72	16.63	21.22	1.52	0.38	18.74	9.32	5.27
6600	11.06	19.70	17.65	22.26	1.51	0.38	18.30	9.12	5.41
6800	11.19	19.51	19.45	21.88	1.47	0.39	17.78	8.73	5.46
7000	11.28	19.50	20.80	21.66	1.47	0.39	17.51	8.52	5.58
7200	11.35	19.31	22.94	19.81	1.43	0.40	17.24	8.10	5.54
7500	11.36	19.09	22.89	17.28	1.40	0.42	17.02	8.10	5.65
8000	10.94	18.77	16.87	14.05	1.39	0.43	15.33	7.12	5.64

REV. X1
GALI-1+
110601
Page 7 of 11



IF/RF MICROWAVE COMPONENTS • ISO 9001 ISO 14001 AS 9100 CERTIFIED • RoHS compliant
P.O. Box 350166, Brooklyn, New York 11235-0003 (718) 934-4500 Fax (718) 332-4661



The Design Engineers Search Engine finds the model you need, Instantly • For detailed performance specs & shopping online see



MMIC Amplifier

GALI-1+

Typical Performance Data

Definitions:

Input Return Loss = -S11 (dB)

Gain(Power Gain) = S21 (dB)

Reverse Isolation = -S12 (dB)

Output Return Loss = -S22 (dB)

TEST CONDITIONS: Icc = 32mA, Vd = 3.18V @Temperature = +85degC

FREQ	Gain	Isolation	Input Return Loss	Output Return Loss	Stability		IP3 Output	1dB Comp. Output	Noise Figure
					K	Delta			
(MHz)	(dB)	(dB)	(dB)	(dB)	K	Delta	(dBm)	(dBm)	(dB)
50	12.04	16.78	28.86	31.82	1.15	0.58	25.06	9.89	4.70
100	12.07	16.70	30.33	29.29	1.14	0.59	24.78	9.76	4.89
200	12.01	16.81	33.07	27.86	1.15	0.57	24.90	10.23	4.78
400	11.95	16.83	28.68	31.04	1.16	0.57	24.27	10.03	4.80
600	11.86	16.87	27.74	30.78	1.17	0.56	24.02	9.94	4.77
800	11.79	16.91	26.14	32.19	1.17	0.55	24.58	9.85	4.84
1000	11.68	16.94	25.11	32.86	1.18	0.54	24.57	9.63	4.79
1200	11.60	16.99	24.20	34.50	1.19	0.54	24.28	9.50	4.84
1400	11.52	17.07	23.50	34.79	1.21	0.53	23.94	9.94	4.94
1600	11.42	17.16	22.76	35.56	1.22	0.52	24.26	9.77	4.93
1800	11.33	17.23	22.07	34.84	1.23	0.51	24.69	9.90	4.91
2000	11.23	17.31	21.00	33.88	1.25	0.50	24.41	9.96	4.69
2200	11.16	17.43	20.11	31.89	1.26	0.49	24.25	9.82	4.70
2400	11.05	17.56	18.94	29.45	1.28	0.47	24.41	9.73	5.00
2600	10.94	17.69	17.95	27.23	1.30	0.46	23.89	9.51	5.05
2800	10.87	17.82	17.09	25.39	1.32	0.45	23.98	9.63	5.01
3000	10.78	17.93	16.25	23.97	1.33	0.45	23.93	9.70	4.86
3200	10.70	18.13	15.54	22.30	1.36	0.44	23.80	9.83	4.95
3400	10.61	18.25	14.88	21.24	1.38	0.43	23.77	10.00	5.16
3600	10.55	18.37	14.41	20.17	1.39	0.42	23.32	9.55	5.13
3800	10.48	18.57	14.11	19.49	1.42	0.41	22.64	9.06	5.29
4000	10.41	18.71	13.78	18.87	1.44	0.41	22.25	9.40	5.16
4200	10.38	18.82	13.78	18.70	1.46	0.40	22.38	9.67	5.09
4400	10.34	18.92	13.80	18.68	1.48	0.40	22.33	9.63	5.15
4600	10.34	19.05	13.99	18.70	1.50	0.39	22.19	9.61	5.47
4800	10.30	19.13	14.16	18.92	1.51	0.38	21.82	9.71	5.53
5000	10.37	19.30	14.12	18.73	1.53	0.38	21.58	9.54	5.43
5200	10.37	19.36	14.32	19.20	1.54	0.38	21.28	9.00	5.33
5400	10.40	19.45	14.33	19.08	1.55	0.37	21.14	8.33	5.18
5600	10.46	19.52	14.34	18.97	1.55	0.37	20.70	8.09	5.36
5800	10.52	19.51	14.48	19.53	1.54	0.37	20.05	8.77	5.43
6000	10.57	19.52	14.68	20.07	1.53	0.37	19.29	8.60	5.45
6200	10.67	19.49	15.18	20.41	1.52	0.38	18.80	8.60	5.22
6400	10.80	19.49	15.55	20.51	1.51	0.38	18.37	8.31	5.17
6600	10.88	19.48	16.46	21.62	1.50	0.38	17.89	8.11	5.35
6800	11.00	19.29	17.90	21.63	1.47	0.39	17.40	7.76	5.42
7000	11.07	19.26	19.02	21.55	1.46	0.39	17.17	7.57	5.54
7200	11.15	19.10	20.69	19.96	1.43	0.41	16.90	7.12	5.46
7500	11.12	18.84	21.07	17.51	1.40	0.42	16.68	7.14	5.59
8000	10.68	18.55	16.43	14.34	1.39	0.43	15.10	6.33	5.55

REV. X1
GALI-1+
110601
Page 8 of 11



IF/RF MICROWAVE COMPONENTS • ISO 9001 ISO 14001 AS 9100 CERTIFIED • RoHS compliant
P.O. Box 350166, Brooklyn, New York 11235-0003 (718) 934-4500 Fax (718) 332-4661



The Design Engineers Search Engine finds the model you need, Instantly • For detailed performance specs & shopping online see



MMIC Amplifier

GALI-1+

Typical Performance Data

Definitions:

Input Return Loss = -S11 (dB)

Gain(Power Gain) = S21 (dB)

Reverse Isolation = -S12 (dB)

Output Return Loss = -S22 (dB)

TEST CONDITIONS: Icc = 48mA, Vd = 3.33V @Temperature = +85degC

FREQ	Gain	Isolation	Input Return Loss	Output Return Loss	Stability		IP3 Output	1dB Comp. Output	Noise Figure
					K	Delta			
(MHz)	(dB)	(dB)	(dB)	(dB)	K	Delta	(dBm)	(dBm)	(dB)
50	12.44	17.07	41.70	24.67	1.14	0.59	31.53	13.91	4.74
100	12.46	17.05	47.48	23.81	1.14	0.59	31.15	13.75	4.96
200	12.40	17.10	42.62	22.84	1.15	0.58	31.16	13.85	4.70
400	12.32	17.13	37.97	24.60	1.15	0.57	30.21	13.88	4.81
600	12.25	17.15	34.77	24.72	1.16	0.57	29.50	13.75	4.75
800	12.16	17.19	31.59	25.46	1.17	0.56	29.67	13.55	4.86
1000	12.07	17.24	29.87	26.04	1.18	0.55	29.34	13.51	4.85
1200	11.96	17.28	28.22	26.65	1.19	0.54	29.09	13.30	4.88
1400	11.88	17.36	27.14	27.13	1.20	0.53	28.60	13.35	5.00
1600	11.77	17.43	26.04	27.96	1.21	0.52	28.92	13.30	5.00
1800	11.69	17.52	25.18	28.94	1.23	0.51	28.56	13.36	4.97
2000	11.59	17.62	23.73	30.80	1.24	0.50	28.28	13.48	4.75
2200	11.50	17.73	22.50	33.32	1.26	0.49	27.87	13.40	4.79
2400	11.40	17.84	21.14	35.42	1.28	0.48	27.50	13.24	5.05
2600	11.30	17.98	19.97	34.12	1.30	0.46	27.04	13.19	5.13
2800	11.20	18.11	18.83	31.03	1.32	0.45	26.75	13.24	5.05
3000	11.12	18.23	17.91	28.15	1.34	0.44	26.41	13.23	4.95
3200	11.02	18.41	17.02	25.70	1.36	0.43	25.83	13.16	5.02
3400	10.95	18.54	16.36	23.98	1.38	0.42	25.51	13.12	5.23
3600	10.87	18.67	15.78	22.53	1.40	0.42	24.93	12.80	5.27
3800	10.79	18.85	15.40	21.61	1.43	0.41	24.26	12.39	5.35
4000	10.73	19.00	15.10	20.79	1.45	0.40	23.87	12.34	5.23
4200	10.68	19.12	15.06	20.59	1.47	0.39	23.76	12.33	5.15
4400	10.65	19.24	15.14	20.41	1.49	0.39	23.70	12.34	5.24
4600	10.63	19.37	15.31	20.43	1.51	0.38	23.49	12.30	5.55
4800	10.60	19.45	15.58	20.56	1.53	0.38	23.11	12.19	5.59
5000	10.66	19.63	15.52	20.32	1.55	0.37	22.68	11.95	5.51
5200	10.65	19.70	15.81	20.77	1.56	0.37	22.21	11.56	5.39
5400	10.69	19.80	15.88	20.49	1.57	0.36	21.85	11.24	5.29
5600	10.74	19.86	15.84	20.36	1.57	0.36	21.34	10.76	5.46
5800	10.80	19.86	16.03	20.87	1.56	0.36	20.68	10.92	5.53
6000	10.86	19.87	16.37	21.42	1.56	0.37	19.87	10.58	5.55
6200	10.96	19.85	16.94	21.68	1.54	0.37	19.35	10.32	5.34
6400	11.10	19.86	17.37	21.68	1.53	0.37	18.92	9.96	5.31
6600	11.17	19.87	18.54	22.63	1.52	0.37	18.50	9.76	5.49
6800	11.30	19.67	20.62	22.10	1.48	0.38	17.98	9.40	5.56
7000	11.39	19.65	22.08	21.78	1.47	0.39	17.71	9.16	5.67
7200	11.48	19.48	24.80	19.83	1.44	0.40	17.42	8.76	5.61
7500	11.50	19.23	23.95	17.22	1.40	0.42	17.19	8.74	5.74
8000	11.11	18.90	17.03	13.94	1.39	0.44	15.44	7.72	5.73

REV. X1
GALI-1+
110601
Page 9 of 11



IF/RF MICROWAVE COMPONENTS • ISO 9001 ISO 14001 AS 9100 CERTIFIED • RoHS compliant
P.O. Box 350166, Brooklyn, New York 11235-0003 (718) 934-4500 Fax (718) 332-4661



The Design Engineers Search Engine finds the model you need, Instantly • For detailed performance specs & shopping online see



Typical Performance Curves

GAIN vs. TEMPERATURE

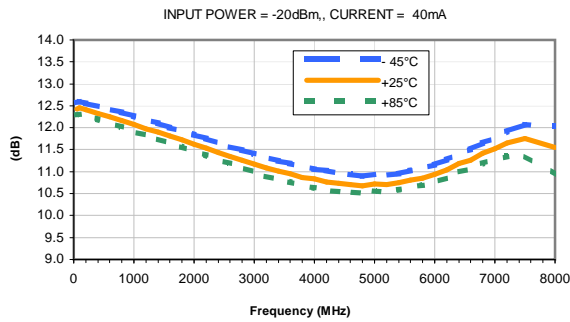

GAIN vs. CURRENT

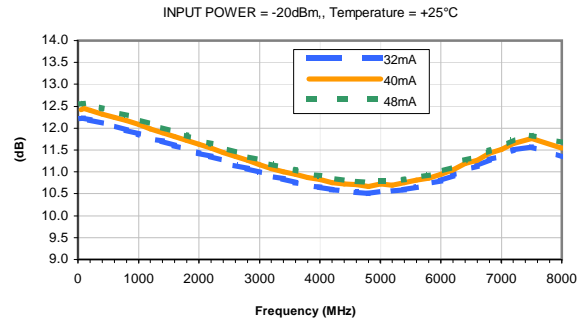

ISOLATION vs. TEMPERATURE

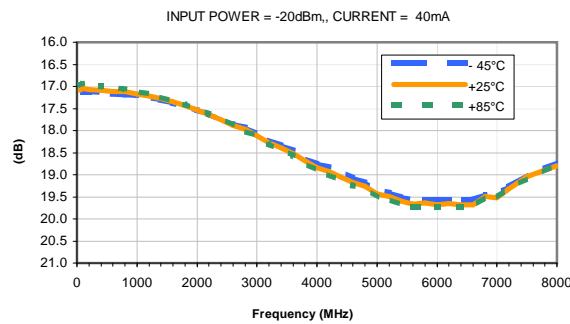

ISOLATION vs. CURRENT

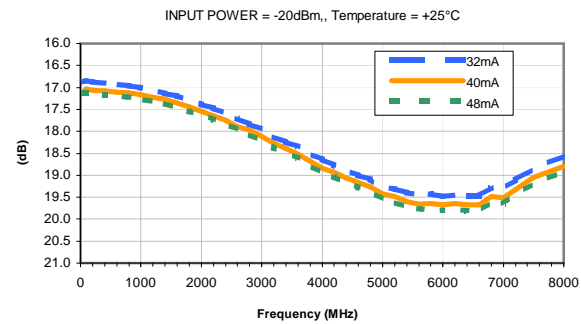

INPUT RETURN LOSS vs. TEMPERATURE

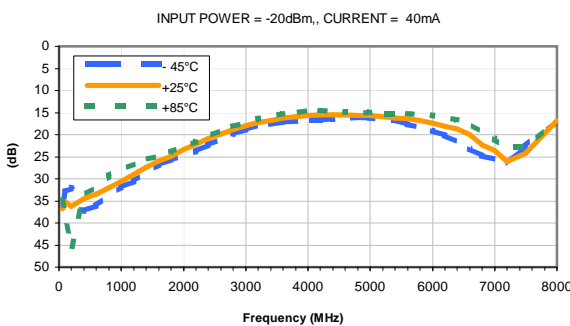

INPUT RETURN LOSS vs. CURRENT

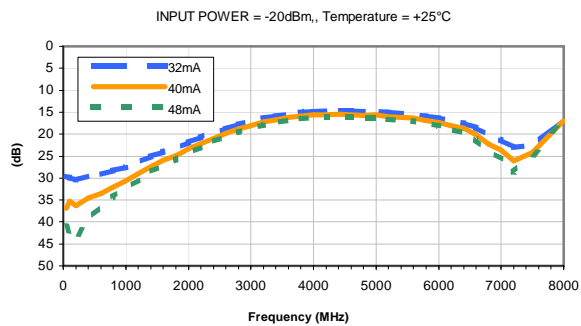

OUTPUT RETURN LOSS vs. TEMPERATURE

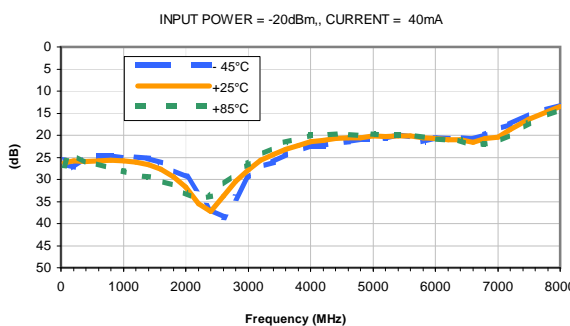

OUTPUT RETURN LOSS vs. CURRENT

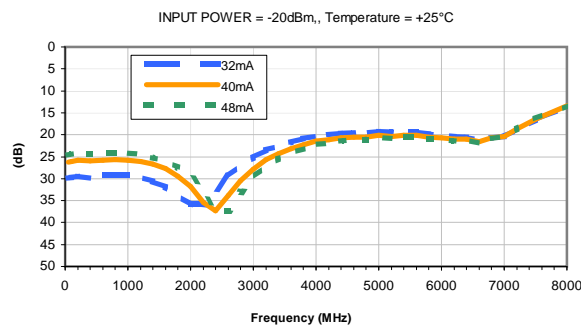

Typical Performance Curves

OUTPUT IP3 vs. TEMPERATURE

INPUT POWER = -20dBm, CURRENT = 40mA

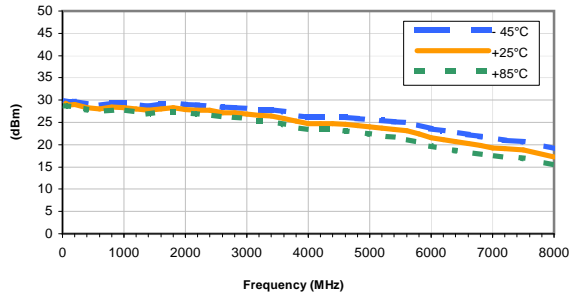

OUTPUT IP3 vs. CURRENT

INPUT POWER = -20dBm, Temperature = +25°C

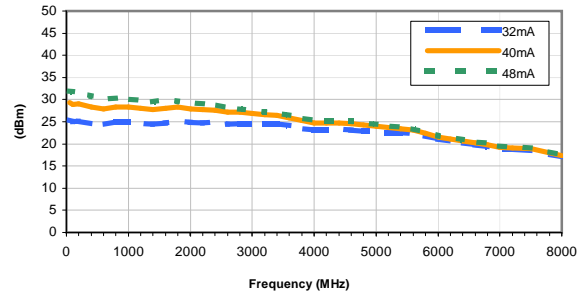

OUTPUT POWER at 1dB Compression vs. TEMPERATURE

CURRENT = 40mA

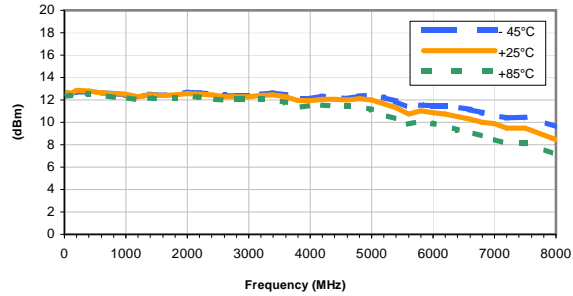

OUTPUT POWER at 1dB Compression vs. CURRENT

Temperature = +25°C

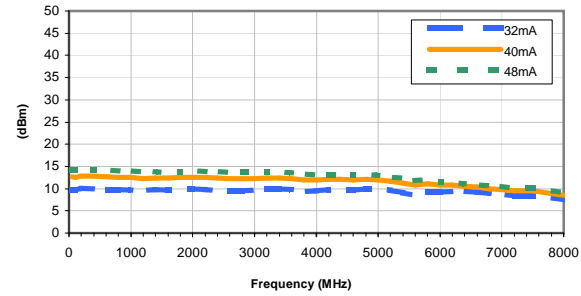

Noise Figure vs. TEMPERATURE

CURRENT = 40mA

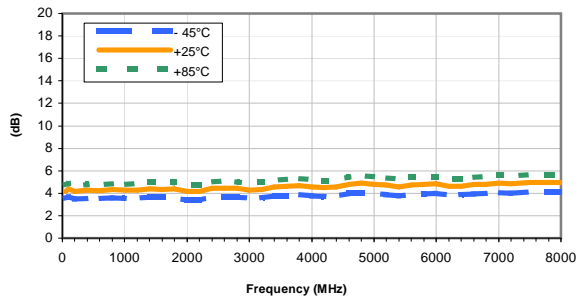

Noise Figure vs. CURRENT

Temperature = +25°C

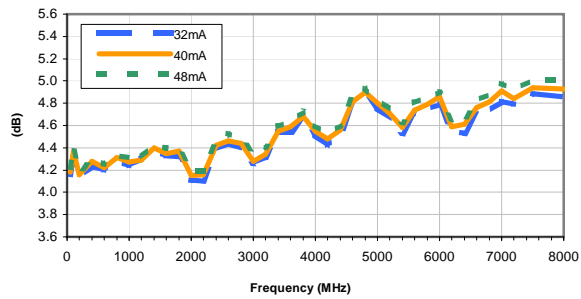

Typical Performance Curves

GAIN vs. TEMPERATURE

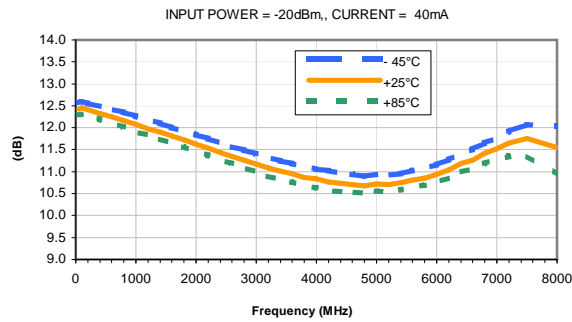

GAIN vs. CURRENT

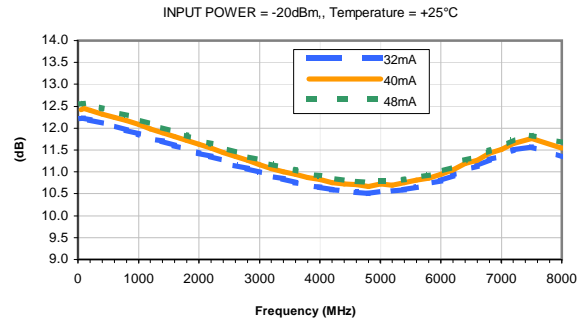

ISOLATION vs. TEMPERATURE

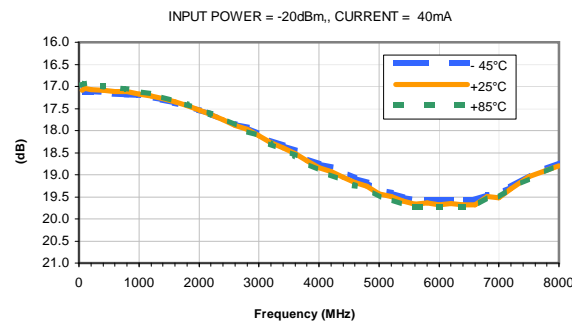

ISOLATION vs. CURRENT

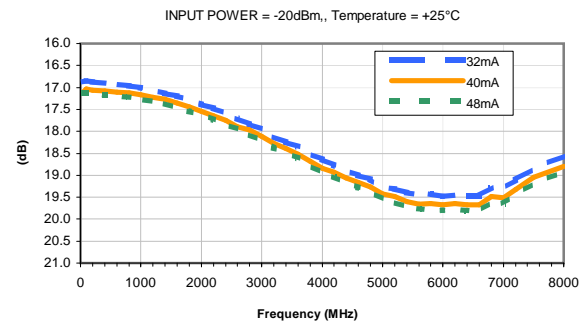

INPUT RETURN LOSS vs. TEMPERATURE

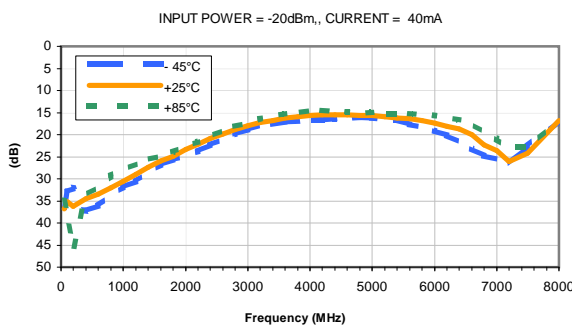

INPUT RETURN LOSS vs. CURRENT

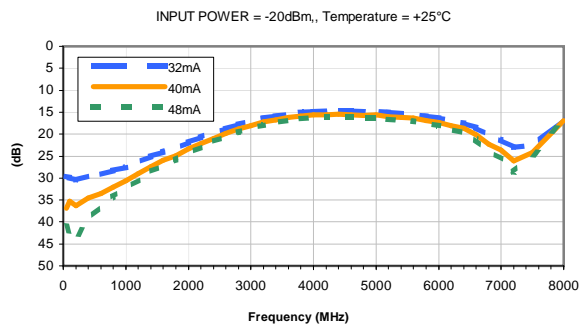

OUTPUT RETURN LOSS vs. TEMPERATURE

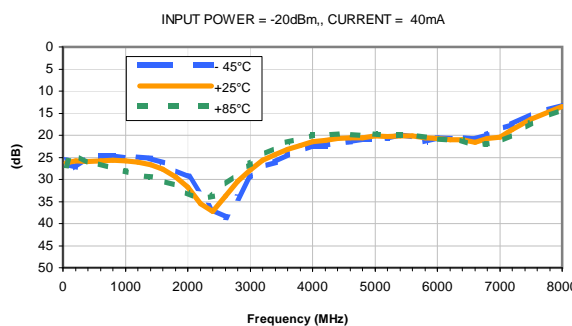

OUTPUT RETURN LOSS vs. CURRENT

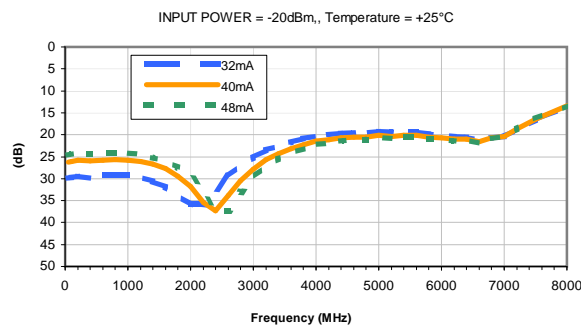

Typical Performance Curves

OUTPUT IP3 vs. TEMPERATURE

INPUT POWER = -20dBm, CURRENT = 40mA

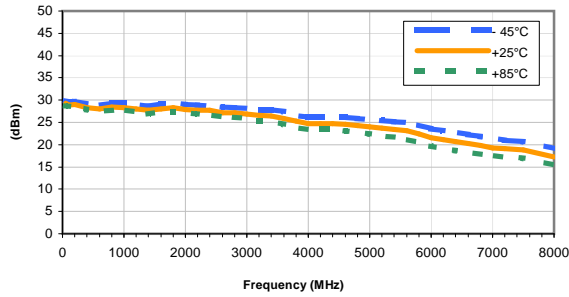

OUTPUT IP3 vs. CURRENT

INPUT POWER = -20dBm, Temperature = +25°C

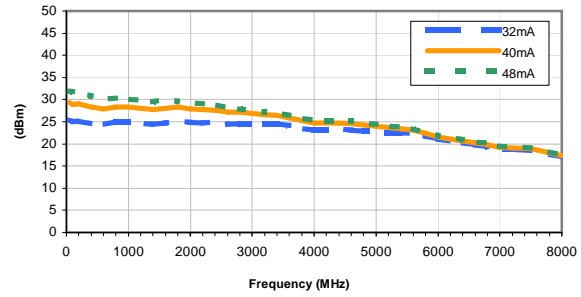

OUTPUT POWER at 1dB Compression vs. TEMPERATURE

CURRENT = 40mA

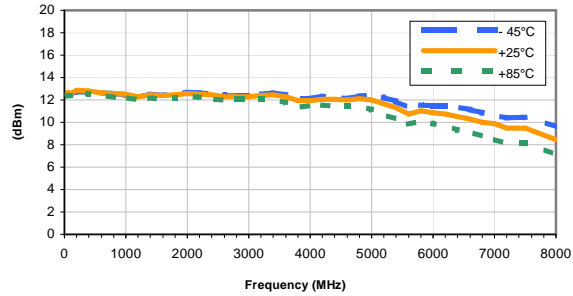

OUTPUT POWER at 1dB Compression vs. CURRENT

Temperature = +25°C

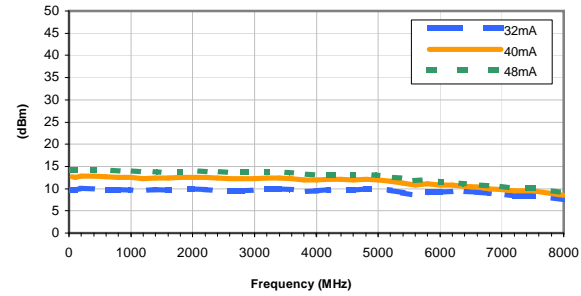

Noise Figure vs. TEMPERATURE

CURRENT = 40mA

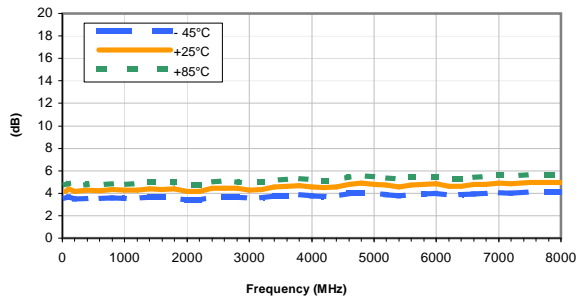

Noise Figure vs. CURRENT

Temperature = +25°C

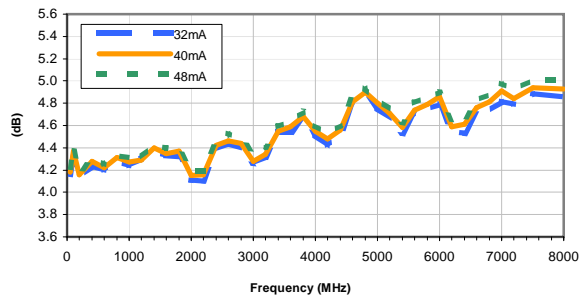

Outline Dimensions



PCB Land Pattern

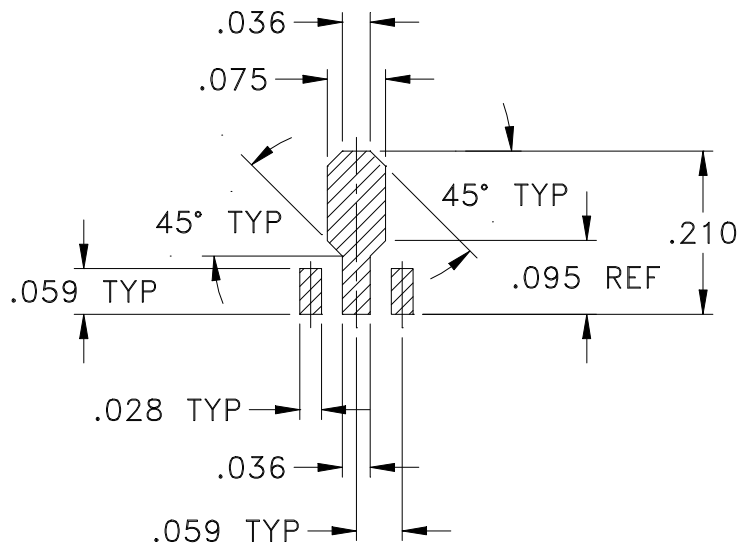

Suggested Layout,
Tolerance to be within $\pm .002$

CASE #	A	B	C	D	E	F	G	H	J	K	L	M
DF782	.102 (2.59)	.090 (2.29)	.181 (4.60)	.173 (4.39)	.063 (1.60)	.167 (4.24)	.155 (3.94)	.059 (1.50)	.118 (3.00)	.015 (0.38)	.041 (1.04)	.016 (0.41)

CASE #	N	P	Q	WT. GRAM
DF782	.019 (0.48)	.065 (1.65)	.062 (1.57)	.2

Dimensions are in inches (mm). Tolerances: 2 Pl. $\pm .01$; 3Pl. $\pm .005$

Notes:

- Case material: Plastic.
- Termination finish:
 For RoHS Case Styles: Tin-Silver alloy plate over Nickel barrier or Matte-Tin.
 All models, (+) suffix. See model Data sheet.
 For RoHS-5 Case Styles: Tin-Lead plate. All models, no (+) suffix.



INTERNET <http://www.minicircuits.com>

P.O. Box 350166, Brooklyn, New York 11235-0003 (718) 934-4500 Fax (718) 332-4661

Distribution Centers NORTH AMERICA 800-654-7949 • 417-335-5935 • Fax 417-335-5945 • EUROPE 44-1252-832600 • Fax 44-1252-837010

Mini-Circuits ISO 9001 & ISO 14001 Certified

Tape & Reel Packaging TR-F55

DEVICE ORIENTATION IN T&R



Tape Width, mm	Device Cavity Pitch, mm	Reel Size, inches	Devices per Reel	
12	8	7	Small quantity standard (see note)	20
				50
				100
				200
				500
			Standard	1000

Note: Please consult individual model data sheet to determine device per reel availability.

Mini-Circuits carrier tape materials provide protection from ESD (Electro-Static Discharge) during handling and transportation. Tapes are static dissipative and comply with industry standards EIA-481/EIA-541.

Go to: www.minicircuits.com/pages/pdfs/tape.pdf



INTERNET <http://www.minicircuits.com>

P.O. Box 350166, Brooklyn, New York 11235-0003 (718) 934-4500 Fax (718) 332-4661

Distribution Centers NORTH AMERICA 800-654-7949 • 417-335-5935 • Fax 417-335-5945 • EUROPE 44-1252-832600 • Fax 44-1252-837010

Mini-Circuits ISO 9001 & ISO 14001 Certified

THIRD ANGLE PROJECTION



REVISIONS

REV	ECN No.	DESCRIPTION	DATE	DR	AUTH
A	M76190	CHANGED DISCRIPTION	04/01	GF	CT
B	M82575	UPDATED DRAWING	08/05/02	AV	LC
C	M102713	ADDED NOTE 2 & "...WITH SMOBC"	01/17/06	MMG	IL
D	M108434	UPDATED DRAWING PER TB-409+	11/14/06	PW	IG

SUGGESTED MOUNTING CONFIGURATION
FOR DF782 CASE STYLE, "mz" PIN CONNECTION



- NOTES:** 1. TRACE WIDTH IS SHOWN FOR ROGERS R04350B WITH DIELECTRIC THICKNESS .030" ± .002"; COPPER: 1/2 OZ. EACH SIDE. FOR OTHER MATERIALS TRACE WIDTH MAY NEED TO BE MODIFIED.
2. BOTTOM SIDE OF THE PCB IS CONTINUOUS GROUND PLANE.



DENOTES PCB COPPER LAYOUT WITH SMOBC (SOLDER MASK OVER BARE COPPER)



DENOTES COPPER LAND PATTERN FREE OF SOLDER MASK

UNLESS OTHERWISE SPECIFIED	INITIALS	DATE
DIMENSIONS ARE IN INCHES TOLERANCES ON: 2 PL DECIMALS ± 3 PL DECIMALS ± .005 ANGLES ± FRACTIONS ±	DRAWN	AV 01/15/01
	CHECKED	YB 01/23/01
	APPROVED	DB 01/23/01

 **Mini-Circuits®** 13 Neptune Avenue
Brooklyn NY 11235

PL, mz, DF782, GALI, TB-409-XXX+

 Mini-Circuits®
THIS DOCUMENT AND ITS CONTENTS ARE THE PROPERTY OF MINI-CIRCUITS. EXCEPT FOR USE EXPRESSLY GRANTED, IN WRITING, TO ITS VENDORS, VENDEE AND THE UNITED STATES GOVERNMENT, MINI-CIRCUITS RESERVES ALL PROPRIETARY DESIGN, USE, MANUFACTURING AND REPRODUCTION RIGHTS THERETO. THESE CONTENTS SHALL NOT BE USED, DUPLICATED OR DISCLOSED TO ANY OUTSIDE PARTY, IN WHOLE OR IN PART, WITHOUT WRITTEN PERMISSION OF MINI-CIRCUITS.

SIZE A	CODE IDENT 15542	DRAWING NO: 98-PL-019	REV: D
FILE: 98PL019	SCALE: 10:1	SHEET: 1 OF 1	

Evaluation Board and Circuit

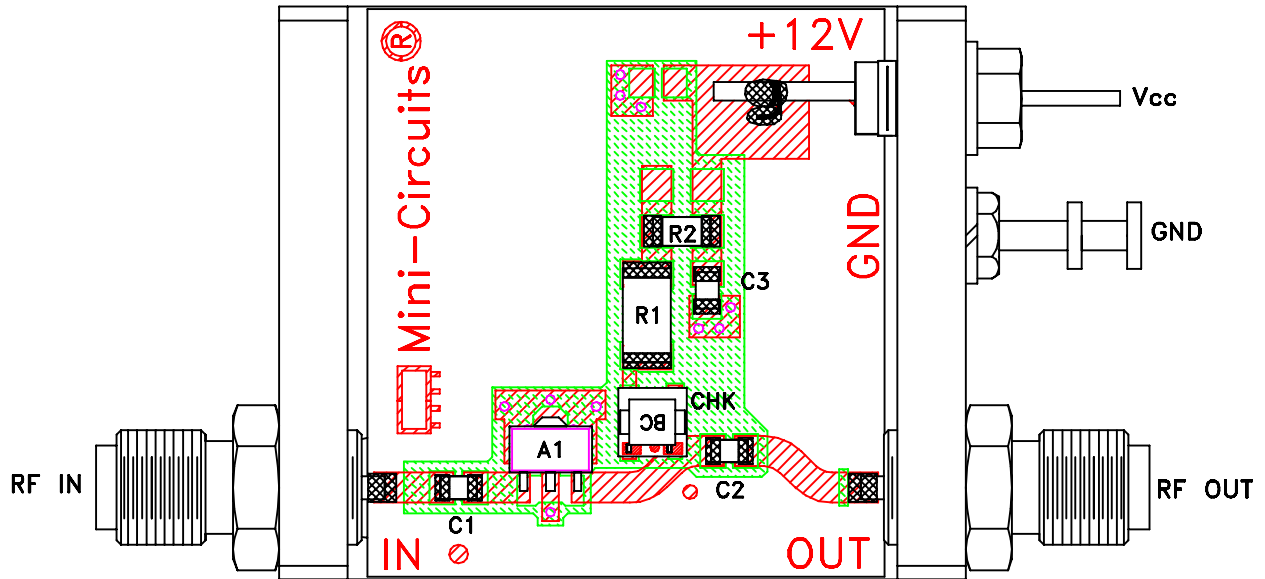

TB-409-1+

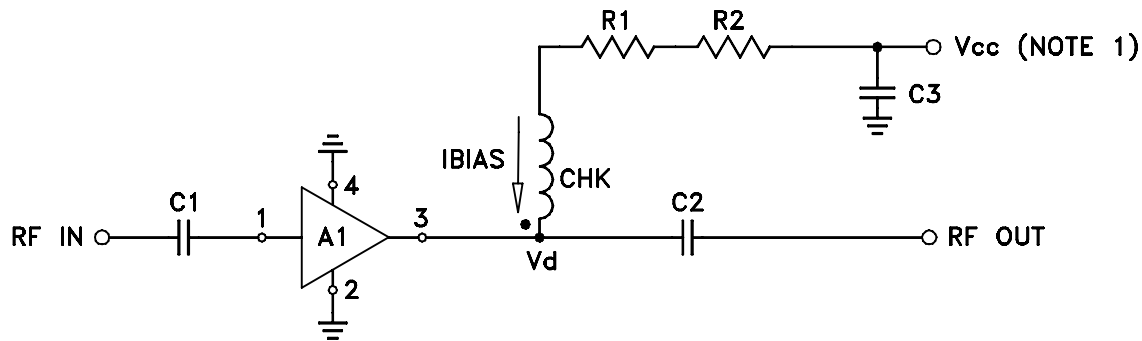

COMPONENT	VALUE
A1	Gali-1(+)
C1 (NOTE 4)	2400 pF
C2 (NOTE 4)	2400 pF
C3 (bypass)	0.1 uF
R1	215 Ohms, 0.75W
R2	0 Ohm, 0.25W
CHK	Mini-Circuits TCCH-80+

Schematic Diagram

NOTE:

1. Vcc voltage: $+12 \pm 0.2V$.
2. SMA Female connectors.
3. PCB material: Rogers R04350 or equivalent, dielectric constant=3.5, dielectric thickness=.030 inch.
4. Capacitors, C1 & C2 should be free of resonance up to the highest frequency specified.

 **Mini-Circuits®**

All Mini-Circuits products are manufactured under exacting quality assurance and control standards, and are capable of meeting published specifications after being subjected to any or all of the following physical and environmental test.

Specification	Test/Inspection Condition	Reference/Spec
Operating Temperature	-45° to 85°C or -40° to 85°C Ambient Environment	Individual Model Data Sheet
Storage Temperature	-65° to 150° C Ambient Environment	Individual Model Data Sheet
Thermal Shock	-55° to 100°C, 100 cycles	MIL-STD-202, Method 107, Condition A-3, except +100°C
Mechanical Shock	1.5Kg, 0.5 ms, 5 shock pulses, Y1 direction only	MIL-STD-883, Method 2002, Condition B, except Y1 direction only
Vibration (Variable Frequency)	50g peak	MIL-STD-883, Method 2007, Condition B
Autoclave	15 psig, 100% RH, 121°C, 96 hours	JESD22-A102, Condition C
HAST	130°C, 85% RH, 96 hours	JESD22-A110
Solderability	10X Magnification	J-STD-002, Para 4.2.5, Test S, 95% Coverage
Solder Reflow Heat	Sn-Pb Eutetic Process: 240°C peak Pb-Free Process: 260°C peak	J-STD-020, Table 4-1, 4-2 and 5-2; Figure 5-1
Moisture Sensitivity: Level 1	Bake at 125°C for 24 hours Soak at 85°C/85% RH for 168 hours, Reflow 3 cycles at 260°C peak	J-STD-020
Marking Resistance to Solvents	Isopropyl alcohol + mineral spirits at 25°C; terpene defluxer at 25°C; distilled water + proylene glycol monomethyl ether +	MIL-STD-202, Method 215



All Mini-Circuits products are manufactured under exacting quality assurance and control standards, and are capable of meeting published specifications after being subjected to any or all of the following physical and environmental test.

Specification	Test/Inspection Condition	Reference/Spec
	monoethanolamine at 63°C to 70°C	