

Surface Mount

# Monolithic Amplifier

DC-7 GHz

## Features

- Miniature SOT-89 Package
- Frequency range, DC to 7 GHz
- Internally Matched to 50 Ohms
- Output power, 10.5 dBm typ.
- Excellent package for heat dissipation, exposed metal bottom
- Aqueous washable
- Protected by US Patent 6,943,629
- Low additive phase noise, typically -172 dBc/Hz @ 10 KHz offset

## Applications

- Cellular
- PCS
- Communication receivers & transmitters
- Suitable for low phase noise applications

## General Description

Gali<sub>39+</sub> (RoHS compliant) is a wideband amplifier offering high dynamic range. It has repeatable performance from lot to lot, and is enclosed in a SOT-89 package. It uses patented Transient Protected Darlington configuration and is fabricated using InGaP HBT technology. Expected MTTF is 4,000 years at 85°C case temperature. Gali<sub>39+</sub> is designed to be rugged for ESD and supply switch-on transients.

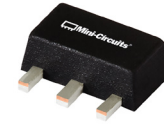

Generic photo used for illustration purposes only

## Gali 39+

CASE STYLE: DF782

**+RoHS Compliant**

The +Suffix identifies RoHS Compliance. See our web site for RoHS Compliance methodologies and qualifications

## simplified schematic and pin description



Function	Pin Number	Description
RF IN	1	RF input pin. This pin requires the use of an external DC blocking capacitor chosen for the frequency of operation.
RF-OUT and DC-IN	3	RF output and bias pin. DC voltage is present on this pin; therefore a DC blocking capacitor is necessary for proper operation. An RF choke is needed to feed DC bias without loss of RF signal due to the bias connection, as shown in "Recommended Application Circuit".
GND	2,4	Connections to ground. Use via holes as shown in "Suggested Layout for PCB Design" to reduce ground path inductance for best performance.

### Notes

- Performance and quality attributes and conditions not expressly stated in this specification document are intended to be excluded and do not form a part of this specification document.
- Electrical specifications and performance data contained in this specification document are based on Mini-Circuit's applicable established test performance criteria and measurement instructions.
- The parts covered by this specification document are subject to Mini-Circuits standard limited warranty and terms and conditions (collectively, "Standard Terms"); Purchasers of this part are entitled to the rights and benefits contained therein. For a full statement of the Standard Terms and the exclusive rights and remedies thereunder, please visit Mini-Circuits' website at [www.minicircuits.com/MCLStore/terms.jsp](http://www.minicircuits.com/MCLStore/terms.jsp)



**Electrical Specifications at 25°C and 35mA, unless noted**

Parameter		Min.	Typ.	Max.	Units
Frequency Range*		DC		7	GHz
Gain	f=0.1 GHz	—	20.8	—	dB
	f=1 GHz	—	21.1	—	
	f=2 GHz	17.7	19.7	—	
	f=3 GHz	—	17.7	—	
	f=4 GHz	—	17.0	—	
	f=5 GHz	—	16.1	—	
	f=7 GHz	—	17.6	—	
Input Return Loss	f= DC to 3 GHz		12.5		dB
	f= 3 to 7 GHz		11		
Output Return Loss	f= DC to 3 GHz		14		dB
	f= 3 to 7 GHz		8.0		
Output Power @ 1 dB compression	f=7 GHz	9.0	10.5	—	dBm
Output IP3	f=2 GHz		22.9		dBm
Noise Figure	f=2 GHz		2.4		dB
Additive Phase Noise	2 GHz, 10 KHz offset		-172		dBc/Hz
Recommended Device Operating Current			35		mA
Device Operating Voltage		3.1	3.5	3.9	V
Device Voltage Variation vs. Temperature at 35 mA			-2.5		mV/°C
Device Voltage Variation vs. Current at 25°C			2.9		mV/mA
Thermal Resistance, junction-to-case <sup>1</sup>			127		°C/W

\*Guaranteed specification DC-7 GHz. Low frequency cut off determined by external coupling capacitors.

**Absolute Maximum Ratings**

Parameter	Ratings
Operating Temperature*	-45°C to 85°C
Storage Temperature	-65°C to 150°C
Operating Current	55mA
Input Power	13dBm

Note: Permanent damage may occur if any of these limits are exceeded.

These ratings are not intended for continuous normal operation.

<sup>1</sup>Case is defined as ground leads.

\*Based on typical case temperature rise 2°C above ambient.

**Notes**

- A. Performance and quality attributes and conditions not expressly stated in this specification document are intended to be excluded and do not form a part of this specification document.
- B. Electrical specifications and performance data contained in this specification document are based on Mini-Circuit's applicable established test performance criteria and measurement instructions.
- C. The parts covered by this specification document are subject to Mini-Circuits standard limited warranty and terms and conditions (collectively, "Standard Terms"); Purchasers of this part are entitled to the rights and benefits contained therein. For a full statement of the Standard Terms and the exclusive rights and remedies thereunder, please visit Mini-Circuits' website at [www.minicircuits.com/MCLStore/terms.jsp](http://www.minicircuits.com/MCLStore/terms.jsp)



**Product Marking**

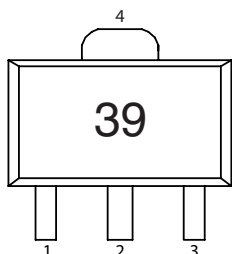

Markings in addition to model number designation may appear for internal quality control purposes.

**Additional Detailed Technical Information**

Additional information is available on our web site. To access this information enter the model number on our web site home page.

**Performance data, graphs, s-parameter data set (.zip file)**

**Case Style: DF782**

Plastic package, exposed paddle, lead finish: Matte-Tin

**Tape & Reel: F55**

7" reels with 20, 50, 100, 200, 500, 1K devices.

**Suggested Layout for PCB Design: PL-019**

**Evaluation Board: TB-409-39+**

**Environmental Ratings: ENV08T2**

**Recommended Application Circuit**

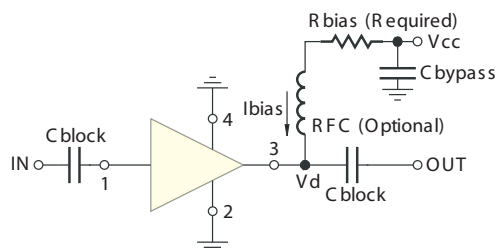

Test Board includes case, connectors, and components (in bold) soldered to PCB

R BIAS	
Vcc	"1%" Res. Values (ohms) for Optimum Biasing
7	107
8	133
9	162
10	191
11	221
12	249
13	280
14	309
15	340
16	365
17	392
18	422
19	453
20	475

**Notes**

- A. Performance and quality attributes and conditions not expressly stated in this specification document are intended to be excluded and do not form a part of this specification document.
- B. Electrical specifications and performance data contained in this specification document are based on Mini-Circuit's applicable established test performance criteria and measurement instructions.
- C. The parts covered by this specification document are subject to Mini-Circuits standard limited warranty and terms and conditions (collectively, "Standard Terms"); Purchasers of this part are entitled to the rights and benefits contained therein. For a full statement of the Standard Terms and the exclusive rights and remedies thereunder, please visit Mini-Circuits' website at [www.minicircuits.com/MCLStore/terms.jsp](http://www.minicircuits.com/MCLStore/terms.jsp)



**ESD Rating**

Human Body Model (HBM): Class 1A (250V to < 500V) in accordance with ANSI/ESD STM 5.1 - 2001

Machine Model (MM): Class M1 (< 100V) in accordance with ANSI/ESD STM 5.2 - 1999

**MSL Rating**

Moisture Sensitivity: MSL1 in accordance with IPC/JEDECJ-STD-020C

No.	Test Required	Condition	Standard	Quantity
1	Visual Inspection	Low Power Microscope Magnification 40x	MIP-IN-0003 (MCT spec)	45 units
2	Electrical Test	Room Temperature	SCD (MCL spec)	45 units
3	SAM Analysis	Less than 10% growth in term of delamination	J-Std-020C (Jedec Standard)	45 units
4	Moisture Sensitivity Level 1	Bake at 125°C for 24 hours Soak at 85°C/85%RH for 168 hours Reflow 3 cycles at 260°C peak	J-Std-020C (Jedec Standard)	45 units

**MSL Test Flow Chart**



**Notes**

- A. Performance and quality attributes and conditions not expressly stated in this specification document are intended to be excluded and do not form a part of this specification document.
- B. Electrical specifications and performance data contained in this specification document are based on Mini-Circuit's applicable established test performance criteria and measurement instructions.
- C. The parts covered by this specification document are subject to Mini-Circuits standard limited warranty and terms and conditions (collectively, "Standard Terms"); Purchasers of this part are entitled to the rights and benefits contained therein. For a full statement of the Standard Terms and the exclusive rights and remedies thereunder, please visit Mini-Circuits' website at [www.minicircuits.com/MCLStore/terms.jsp](http://www.minicircuits.com/MCLStore/terms.jsp)



# MMIC Amplifier

# GALI-39+

## Typical Performance Data

**NOTE: Use PDF Bookmarks to view DATA at required conditions  
or to view GRAPHS.**

### Definitions:

Input Return Loss = -S11 (dB)

Gain(Power Gain) = S21 (dB)

Reverse Isolation = -S12 (dB)

Output Return Loss = -S22 (dB)

TEST CONDITIONS: Icc = 35mA, Vd = 3.61V @Temperature = +25degC

FREQ	Gain	Isolation	Input Return Loss	Output Return Loss	Stability		IP3 Output	1dB Comp. Output	Noise Figure
					K	Delta			
(MHz)	(dB)	(dB)	(dB)	(dB)	K	Delta	(dBm)	(dBm)	(dB)
50	23.37	25.47	34.83	26.79	1.03	0.79	25.44	12.34	2.10
100	23.39	25.50	34.38	26.25	1.03	0.79	25.39	12.09	2.30
200	23.29	25.46	33.11	25.57	1.03	0.78	25.42	12.17	2.16
300	23.17	25.47	31.75	25.11	1.03	0.77	25.44	12.08	2.38
400	23.03	25.42	31.39	24.15	1.04	0.76	25.00	12.15	2.20
500	22.86	25.40	29.97	23.72	1.04	0.75	24.87	11.98	2.34
600	22.69	25.33	29.35	23.12	1.04	0.74	24.76	12.06	2.21
700	22.51	25.32	28.81	22.85	1.05	0.73	25.10	12.19	2.22
800	22.31	25.28	28.51	22.49	1.06	0.71	25.31	12.14	2.23
1000	21.91	25.19	28.11	22.07	1.07	0.69	25.34	11.98	2.24
1200	21.51	25.12	28.00	21.81	1.08	0.66	25.07	11.64	2.32
1400	21.11	25.02	27.49	21.80	1.10	0.64	24.75	11.89	2.38
1600	20.70	24.94	27.18	22.13	1.12	0.62	24.96	11.59	2.43
1800	20.29	24.87	26.21	22.55	1.14	0.59	25.45	11.52	2.35
2000	19.89	24.77	25.06	23.11	1.15	0.57	25.50	11.68	2.32
2200	19.52	24.71	24.17	23.94	1.18	0.55	25.44	11.94	2.39
2400	19.12	24.64	23.04	25.04	1.20	0.53	25.35	11.97	2.40
2600	18.78	24.61	22.03	26.52	1.22	0.51	25.24	11.59	2.36
2800	18.46	24.56	20.61	27.98	1.24	0.49	25.30	11.63	2.41
3000	18.16	24.48	19.32	28.80	1.26	0.48	25.48	11.64	2.43
3200	17.88	24.48	18.24	29.80	1.28	0.46	25.44	11.47	2.44
3400	17.61	24.41	17.32	29.02	1.30	0.45	25.38	11.72	2.54
3600	17.37	24.38	16.57	27.52	1.32	0.44	25.02	11.62	2.69
3800	17.13	24.45	15.95	26.07	1.35	0.43	24.73	11.67	2.70
4000	16.91	24.48	15.59	24.69	1.37	0.42	24.70	11.94	2.70
4200	16.71	24.50	15.43	23.83	1.39	0.41	24.80	11.79	2.62
4400	16.56	24.48	14.98	23.08	1.41	0.41	24.78	11.68	2.67
4600	16.42	24.50	15.08	22.74	1.43	0.40	24.49	11.56	2.68
4800	16.29	24.58	15.07	22.11	1.45	0.40	24.15	11.63	2.81
5000	16.25	24.62	15.08	21.88	1.46	0.39	23.82	11.93	2.77
5200	16.19	24.71	15.07	21.68	1.48	0.39	23.81	11.69	2.64
5400	16.17	24.80	15.22	21.42	1.50	0.38	23.57	11.41	2.66
5600	16.13	24.78	15.81	21.06	1.51	0.38	23.45	11.41	2.75
5800	16.14	24.82	16.18	20.94	1.51	0.38	23.03	10.72	2.84
6000	16.19	24.89	16.25	20.98	1.52	0.38	22.40	10.46	2.87
6200	16.18	24.83	16.75	21.20	1.51	0.38	22.22	10.55	2.92
6400	16.22	24.93	17.01	21.15	1.52	0.38	21.97	10.34	2.94
6600	16.14	24.95	17.10	21.70	1.54	0.37	21.69	10.41	2.95
6800	16.28	24.42	18.41	18.94	1.45	0.41	21.31	10.23	3.02
7000	16.07	24.63	16.76	18.74	1.50	0.39	20.98	10.09	3.10

REV. X1  
GALI-39+  
070828

Page 1 of 11



IF/RF MICROWAVE COMPONENTS • ISO 9001 ISO 14001 AS 9100 CERTIFIED • RoHS compliant

P.O. Box 350166, Brooklyn, New York 11235-0003 (718) 934-4500 Fax (718) 332-4661



The Design Engineers Search Engine finds the model you need, Instantly • For detailed performance specs & shopping online see



## Typical Performance Data

### Definitions:

Input Return Loss = -S11 (dB)

Gain(Power Gain) = S21 (dB)

Reverse Isolation = -S12 (dB)

Output Return Loss = -S22 (dB)

TEST CONDITIONS: I<sub>cc</sub> = 28mA, V<sub>d</sub> = 3.59V @Temperature = +25degC

FREQ	Gain	Isolation	Input Return Loss	Output Return Loss	Stability		IP3 Output	1dB Comp. Output	Noise Figure
					K	Delta			
(MHz)	(dB)	(dB)	(dB)	(dB)	K	Delta	(dBm)	(dBm)	(dB)
50	22.68	24.88	26.23	33.35	1.03	0.78	22.13	9.02	2.11
100	22.69	24.85	26.64	32.85	1.03	0.78	22.11	8.97	2.23
200	22.61	24.83	26.34	33.97	1.03	0.77	22.11	9.19	2.19
300	22.49	24.84	27.36	32.65	1.04	0.76	22.12	8.82	2.31
400	22.36	24.78	27.18	33.30	1.04	0.76	21.70	8.90	2.26
500	22.24	24.76	27.71	32.23	1.04	0.75	21.61	8.98	2.29
600	22.08	24.70	27.01	31.91	1.04	0.74	21.55	8.89	2.27
700	21.88	24.68	27.54	31.10	1.05	0.72	21.91	9.11	2.16
800	21.72	24.66	27.59	30.66	1.05	0.71	22.16	9.09	2.26
1000	21.38	24.59	26.74	29.58	1.07	0.69	22.22	8.89	2.22
1200	21.00	24.53	25.78	28.62	1.08	0.66	21.94	8.69	2.31
1400	20.62	24.46	24.43	27.96	1.09	0.64	21.69	8.78	2.36
1600	20.20	24.42	23.26	27.64	1.11	0.61	21.92	8.67	2.39
1800	19.83	24.39	22.11	27.24	1.13	0.59	22.60	8.58	2.30
2000	19.46	24.32	20.89	27.07	1.15	0.57	22.69	8.87	2.27
2200	19.09	24.28	20.13	27.38	1.17	0.55	22.85	8.97	2.35
2400	18.71	24.25	19.19	27.25	1.19	0.52	22.97	8.98	2.33
2600	18.38	24.25	18.48	27.05	1.22	0.50	23.03	9.16	2.32
2800	18.07	24.21	17.46	26.15	1.24	0.49	23.28	8.85	2.37
3000	17.79	24.16	16.56	25.25	1.25	0.47	23.57	8.79	2.39
3200	17.49	24.19	15.66	24.58	1.28	0.46	23.55	8.69	2.42
3400	17.23	24.15	15.03	23.63	1.29	0.45	23.52	8.81	2.53
3600	17.00	24.16	14.44	22.53	1.31	0.44	23.29	8.73	2.66
3800	16.76	24.25	14.01	21.63	1.34	0.42	23.18	8.60	2.71
4000	16.56	24.30	13.71	20.90	1.37	0.42	23.28	9.02	2.69
4200	16.38	24.34	13.66	20.28	1.39	0.41	23.42	9.13	2.61
4400	16.23	24.34	13.30	20.03	1.41	0.40	23.28	9.06	2.66
4600	16.09	24.37	13.42	19.86	1.43	0.40	23.02	8.95	2.70
4800	15.97	24.46	13.41	19.63	1.46	0.39	22.78	9.14	2.77
5000	15.92	24.52	13.48	19.49	1.47	0.39	22.61	9.61	2.70
5200	15.87	24.62	13.50	19.55	1.49	0.38	22.85	9.26	2.61
5400	15.83	24.71	13.56	19.38	1.51	0.38	22.81	9.22	2.62
5600	15.81	24.70	14.07	19.36	1.52	0.38	22.88	8.71	2.70
5800	15.82	24.74	14.35	19.46	1.53	0.38	22.59	8.86	2.77
6000	15.85	24.80	14.28	19.53	1.53	0.38	22.05	8.80	2.80
6200	15.86	24.74	14.65	19.99	1.53	0.38	21.99	8.99	2.85
6400	15.90	24.81	14.72	20.05	1.53	0.38	21.75	9.26	2.86
6600	15.80	24.83	14.84	20.95	1.55	0.37	21.46	9.33	2.86
6800	15.91	24.29	15.66	18.66	1.47	0.40	21.19	9.39	2.94
7000	15.70	24.50	14.59	18.95	1.51	0.38	20.84	9.17	3.03

## Typical Performance Data

### Definitions:

Input Return Loss = -S11 (dB)

Gain(Power Gain) = S21 (dB)

Reverse Isolation = -S12 (dB)

Output Return Loss = -S22 (dB)

TEST CONDITIONS: Icc = 42mA, Vd = 3.63V @Temperature = +25degC

FREQ	Gain	Isolation	Input Return Loss	Output Return Loss	Stability		IP3 Output	1dB Comp. Output	Noise Figure
					K	Delta			
(MHz)	(dB)	(dB)	(dB)	(dB)	K	Delta	(dBm)	(dBm)	(dB)
50	23.78	25.91	24.23	20.89	1.03	0.79	28.15	14.41	2.12
100	23.79	25.91	24.65	20.82	1.03	0.79	28.11	14.24	2.34
200	23.67	25.90	24.29	20.60	1.03	0.78	28.14	14.20	2.13
300	23.55	25.87	24.32	20.25	1.03	0.77	28.10	14.14	2.43
400	23.40	25.85	23.70	19.93	1.04	0.76	27.59	14.25	2.20
500	23.22	25.77	23.89	19.64	1.04	0.75	27.29	14.02	2.41
600	23.05	25.75	23.38	19.47	1.04	0.74	27.08	14.09	2.24
700	22.85	25.70	23.60	19.14	1.05	0.73	27.26	14.05	2.26
800	22.64	25.66	23.60	19.00	1.06	0.71	27.34	14.11	2.23
1000	22.23	25.55	23.80	18.90	1.07	0.69	27.23	13.98	2.24
1200	21.81	25.44	24.15	18.95	1.08	0.67	26.94	13.73	2.33
1400	21.39	25.35	24.79	19.21	1.10	0.64	26.54	13.76	2.42
1600	20.97	25.26	25.44	19.35	1.12	0.62	26.64	13.64	2.45
1800	20.55	25.17	25.91	19.81	1.14	0.59	26.68	13.62	2.39
2000	20.15	25.05	26.19	20.43	1.16	0.57	26.67	13.80	2.37
2200	19.75	24.97	26.18	21.32	1.18	0.55	26.54	13.94	2.44
2400	19.37	24.88	25.51	22.41	1.20	0.53	26.24	13.88	2.43
2600	19.01	24.83	24.73	23.88	1.22	0.51	25.95	13.89	2.41
2800	18.68	24.75	23.17	25.58	1.24	0.50	25.84	13.67	2.44
3000	18.39	24.65	21.60	27.16	1.26	0.48	25.83	13.55	2.47
3200	18.10	24.62	20.34	30.17	1.28	0.47	25.71	13.71	2.49
3400	17.82	24.56	19.26	31.36	1.30	0.46	25.60	13.65	2.57
3600	17.58	24.51	18.25	31.41	1.32	0.45	25.15	13.62	2.70
3800	17.33	24.55	17.50	30.12	1.34	0.43	24.85	13.53	2.72
4000	17.12	24.56	17.07	27.91	1.37	0.43	24.72	13.61	2.73
4200	16.91	24.57	16.70	26.71	1.39	0.42	24.77	13.62	2.64
4400	16.76	24.54	16.23	25.62	1.40	0.41	24.63	13.49	2.66
4600	16.61	24.55	16.24	25.00	1.42	0.41	24.38	13.28	2.73
4800	16.48	24.62	16.29	24.00	1.45	0.40	23.97	13.26	2.82
5000	16.44	24.66	16.23	23.72	1.45	0.40	23.60	13.17	2.80
5200	16.39	24.73	16.22	23.42	1.47	0.39	23.55	12.78	2.71
5400	16.36	24.82	16.46	22.86	1.49	0.39	23.30	12.55	2.71
5600	16.32	24.80	17.08	22.38	1.49	0.39	23.04	12.14	2.83
5800	16.34	24.85	17.57	22.19	1.50	0.39	22.64	11.94	2.90
6000	16.38	24.91	17.77	22.04	1.50	0.38	21.98	11.49	2.93
6200	16.39	24.85	18.46	22.15	1.50	0.39	21.83	11.21	2.99
6400	16.44	24.96	18.87	22.01	1.50	0.38	21.61	11.05	3.02
6600	16.36	24.99	19.02	22.28	1.52	0.38	21.29	11.05	3.04
6800	16.52	24.47	21.04	19.23	1.43	0.41	20.95	10.86	3.12
7000	16.32	24.68	18.56	18.70	1.48	0.40	20.57	10.52	3.20

REV. X1  
GALI-39+  
070828

Page 3 of 11



IF/RF MICROWAVE COMPONENTS • ISO 9001 ISO 14001 AS 9100 CERTIFIED • RoHS compliant

P.O. Box 350166, Brooklyn, New York 11235-0003 (718) 934-4500 Fax (718) 332-4661



The Design Engineers Search Engine finds the model you need, Instantly • For detailed performance specs & shopping online see



## Typical Performance Data

### Definitions:

Input Return Loss = -S11 (dB)

Gain(Power Gain) = S21 (dB)

Reverse Isolation = -S12 (dB)

Output Return Loss = -S22 (dB)

TEST CONDITIONS: Icc = 35mA, Vd = 3.80V @Temperature = -45degC

FREQ	Gain	Isolation	Input Return Loss	Output Return Loss	Stability		IP3 Output	1dB Comp. Output	Noise Figure
					K	Delta			
(MHz)	(dB)	(dB)	(dB)	(dB)	K	Delta	(dBm)	(dBm)	(dB)
50	23.66	25.69	29.87	24.24	1.03	0.79	25.83	12.27	1.67
100	23.66	25.71	31.44	24.67	1.03	0.79	25.73	11.86	1.92
200	23.56	25.67	31.83	25.22	1.03	0.79	25.75	11.95	1.72
300	23.46	25.65	29.33	23.15	1.03	0.78	25.90	11.72	1.97
400	23.30	25.62	26.54	21.93	1.03	0.77	25.55	12.21	1.82
500	23.16	25.57	26.15	21.15	1.04	0.76	25.45	11.91	1.92
600	22.98	25.53	25.22	21.12	1.04	0.75	25.39	12.17	1.81
700	22.81	25.47	25.70	20.59	1.04	0.74	25.72	12.09	1.76
800	22.63	25.43	25.83	20.68	1.05	0.73	25.95	12.09	1.79
1000	22.23	25.34	26.02	20.53	1.06	0.70	26.03	11.84	1.76
1200	21.83	25.25	25.68	20.22	1.07	0.68	25.82	11.59	1.83
1400	21.42	25.15	25.47	20.18	1.09	0.66	25.53	11.82	1.89
1600	21.04	25.08	25.83	20.65	1.11	0.63	25.76	11.58	1.92
1800	20.63	25.00	25.80	21.21	1.12	0.61	26.27	11.31	1.85
2000	20.25	24.88	25.29	21.87	1.14	0.59	26.39	11.53	1.81
2200	19.88	24.81	25.09	22.34	1.16	0.57	26.30	11.88	1.88
2400	19.48	24.74	24.40	23.43	1.18	0.55	26.26	11.98	1.84
2600	19.15	24.68	23.62	25.03	1.20	0.53	26.14	11.77	1.82
2800	18.83	24.59	22.27	26.97	1.22	0.51	26.27	11.56	1.87
3000	18.55	24.52	21.09	28.48	1.23	0.50	26.47	11.54	1.87
3200	18.27	24.49	20.07	31.50	1.25	0.49	26.53	11.72	1.92
3400	18.01	24.42	19.13	31.74	1.27	0.48	26.51	11.88	1.95
3600	17.78	24.39	18.11	30.34	1.28	0.47	26.13	11.48	2.10
3800	17.54	24.42	17.32	28.47	1.31	0.45	25.87	11.68	2.11
4000	17.34	24.41	16.90	26.27	1.33	0.45	25.81	11.84	2.12
4200	17.16	24.41	16.62	25.42	1.34	0.44	26.02	12.01	2.05
4400	17.02	24.36	16.40	24.57	1.35	0.43	26.01	11.85	2.03
4600	16.86	24.38	16.45	24.22	1.37	0.43	25.75	11.64	2.06
4800	16.75	24.44	16.48	22.86	1.39	0.42	25.37	11.75	2.11
5000	16.70	24.47	16.19	22.61	1.40	0.42	25.03	12.25	2.12
5200	16.62	24.52	16.31	22.05	1.42	0.41	25.05	12.08	2.05
5400	16.60	24.63	16.45	21.13	1.43	0.41	24.97	11.95	2.06
5600	16.54	24.56	16.56	20.56	1.43	0.41	24.72	11.91	2.09
5800	16.62	24.69	16.97	19.95	1.44	0.41	24.37	11.46	2.15
6000	16.67	24.71	17.64	20.09	1.44	0.41	23.76	11.39	2.17
6200	16.73	24.65	18.54	20.33	1.43	0.41	23.59	11.26	2.28
6400	16.82	24.71	19.25	20.14	1.43	0.41	23.39	11.31	2.29
6600	16.82	24.79	19.22	21.00	1.44	0.41	23.00	11.42	2.28
6800	16.97	24.33	20.63	18.84	1.37	0.44	22.76	11.27	2.29
7000		24.53	18.37	19.01	1.40	0.43	22.08	11.21	2.39



## Typical Performance Data

### Definitions:

Input Return Loss = -S11 (dB)

Gain(Power Gain) = S21 (dB)

Reverse Isolation = -S12 (dB)

Output Return Loss = -S22 (dB)

TEST CONDITIONS: Icc = 28mA, Vd = 3.77V @Temperature = -45degC

FREQ	Gain	Isolation	Input Return Loss	Output Return Loss	Stability		IP3 Output	1dB Comp. Output	Noise Figure
					K	Delta			
(MHz)	(dB)	(dB)	(dB)	(dB)	K	Delta	(dBm)	(dBm)	(dB)
50	23.06	25.11	32.05	55.56	1.03	0.79	22.36	9.09	1.68
100	23.01	25.12	29.26	41.07	1.03	0.78	22.28	8.62	1.86
200	22.95	25.08	29.33	37.76	1.03	0.78	22.26	8.95	1.77
300	22.85	25.08	30.42	36.59	1.03	0.77	22.37	8.87	1.89
400	22.71	25.00	33.76	32.56	1.03	0.77	22.06	8.79	1.85
500	22.60	25.00	31.45	29.89	1.04	0.76	22.00	9.10	1.87
600	22.42	24.95	31.08	29.49	1.04	0.75	21.98	9.02	1.83
700	22.26	24.90	29.92	27.78	1.04	0.74	22.35	9.17	1.73
800	22.10	24.88	29.53	27.74	1.05	0.73	22.59	8.74	1.82
1000	21.74	24.81	28.62	26.92	1.06	0.70	22.67	8.58	1.77
1200	21.38	24.73	28.10	25.84	1.07	0.68	22.41	8.51	1.81
1400	20.99	24.67	26.87	25.24	1.09	0.65	22.23	8.71	1.86
1600	20.61	24.58	25.45	25.59	1.10	0.63	22.47	8.65	1.91
1800	20.24	24.54	24.40	25.82	1.12	0.61	23.13	8.75	1.83
2000	19.88	24.46	22.79	26.52	1.13	0.59	23.29	8.71	1.79
2200	19.51	24.42	22.24	26.75	1.16	0.57	23.24	9.11	1.83
2400	19.13	24.39	21.10	27.82	1.18	0.54	23.39	8.98	1.81
2600	18.80	24.35	20.13	28.89	1.20	0.52	23.48	8.81	1.78
2800	18.49	24.30	18.92	29.07	1.21	0.51	23.75	8.99	1.83
3000	18.21	24.25	18.03	28.14	1.23	0.49	24.07	8.97	1.84
3200	17.94	24.25	17.25	26.53	1.25	0.48	24.18	8.77	1.89
3400	17.68	24.21	16.54	25.70	1.27	0.47	24.17	8.80	1.95
3600	17.46	24.20	15.79	24.37	1.28	0.46	23.91	8.66	2.07
3800	17.22	24.26	15.23	23.28	1.31	0.45	23.73	8.76	2.09
4000	17.03	24.27	14.97	22.12	1.33	0.44	23.87	8.96	2.10
4200	16.87	24.29	14.76	21.73	1.35	0.43	24.17	9.13	2.03
4400	16.73	24.26	14.58	21.27	1.36	0.43	24.06	9.10	2.04
4600	16.58	24.29	14.64	21.22	1.38	0.42	23.80	8.77	2.03
4800	16.47	24.36	14.72	20.35	1.40	0.42	23.39	9.09	2.10
5000	16.41	24.42	14.47	20.30	1.41	0.41	23.30	9.79	2.10
5200	16.33	24.46	14.61	20.01	1.43	0.41	23.56	9.66	2.01
5400	16.31	24.59	14.75	19.34	1.45	0.40	23.71	9.62	1.99
5600	16.25	24.53	14.76	19.22	1.45	0.40	23.79	8.95	2.02
5800	16.34	24.64	15.14	18.87	1.46	0.40	23.58	9.01	2.08
6000	16.39	24.67	15.61	19.09	1.46	0.40	23.10	9.23	2.10
6200	16.45	24.61	16.20	19.50	1.45	0.41	23.00	9.43	2.21
6400	16.54	24.65	16.56	19.46	1.44	0.41	22.84	9.77	2.22
6600	16.54	24.71	16.47	20.57	1.45	0.40	22.52	9.91	2.20
6800	16.67	24.25	17.32	18.74	1.38	0.43	22.27	9.96	2.23
7000	16.53	24.43	15.89	19.21	1.41	0.42	21.70	9.86	2.33

## Typical Performance Data

### Definitions:

Input Return Loss = -S11 (dB)

Gain(Power Gain) = S21 (dB)

Reverse Isolation = -S12 (dB)

Output Return Loss = -S22 (dB)

TEST CONDITIONS: Icc = 42mA, Vd = 3.82V @Temperature = -45degC

FREQ	Gain	Isolation	Input Return Loss	Output Return Loss	Stability		IP3 Output	1dB Comp. Output	Noise Figure
					K	Delta			
(MHz)	(dB)	(dB)	(dB)	(dB)	K	Delta	(dBm)	(dBm)	(dB)
50	24.01	26.06	23.21	19.91	1.03	0.80	28.66	14.46	1.71
100	24.02	26.09	23.79	20.15	1.03	0.79	28.58	14.43	1.96
200	23.92	26.05	24.44	20.57	1.03	0.79	28.64	14.24	1.73
300	23.81	26.03	23.09	19.34	1.03	0.78	28.76	14.27	2.01
400	23.64	25.99	21.81	18.61	1.03	0.77	28.34	14.37	1.80
500	23.49	25.95	21.72	18.17	1.04	0.76	28.10	14.14	1.95
600	23.29	25.91	21.40	18.05	1.04	0.75	27.94	14.34	1.79
700	23.12	25.84	21.59	17.88	1.04	0.74	28.17	14.38	1.80
800	22.93	25.79	21.90	18.00	1.05	0.73	28.28	14.14	1.80
1000	22.52	25.68	22.28	17.98	1.06	0.70	28.25	13.99	1.78
1200	22.11	25.58	22.37	17.90	1.07	0.68	28.03	13.87	1.84
1400	21.70	25.46	22.54	17.96	1.09	0.66	27.68	13.87	1.91
1600	21.27	25.36	23.29	18.47	1.11	0.63	27.79	13.80	1.97
1800	20.86	25.26	23.97	19.01	1.12	0.61	27.93	13.64	1.89
2000	20.47	25.12	24.63	19.59	1.14	0.59	28.02	13.97	1.87
2200	20.09	25.04	25.10	20.10	1.16	0.57	27.91	14.14	1.91
2400	19.69	24.95	25.40	21.10	1.18	0.55	27.63	14.01	1.88
2600	19.36	24.87	25.75	22.54	1.20	0.53	27.33	13.86	1.83
2800	19.05	24.75	25.01	24.33	1.22	0.52	27.29	13.82	1.90
3000	18.75	24.67	23.72	25.91	1.23	0.50	27.36	13.71	1.90
3200	18.47	24.62	22.50	29.97	1.25	0.49	27.29	13.74	1.93
3400	18.20	24.54	21.36	32.12	1.27	0.48	27.14	13.79	1.97
3600	17.97	24.49	20.00	34.48	1.28	0.47	26.77	13.73	2.10
3800	17.72	24.51	19.07	33.62	1.31	0.46	26.50	13.56	2.12
4000	17.53	24.48	18.45	30.07	1.32	0.45	26.26	13.83	2.14
4200	17.35	24.47	18.12	28.45	1.34	0.44	26.38	13.82	2.06
4400	17.19	24.42	17.73	27.29	1.35	0.44	26.36	13.65	2.07
4600	17.06	24.43	17.82	26.63	1.37	0.43	26.17	13.58	2.09
4800	16.92	24.46	17.77	24.88	1.38	0.43	25.81	13.75	2.16
5000	16.89	24.49	17.56	24.41	1.39	0.42	25.41	13.83	2.15
5200	16.81	24.52	17.65	23.69	1.40	0.42	25.34	13.70	2.09
5400	16.79	24.64	17.79	22.47	1.42	0.41	25.11	13.37	2.12
5600	16.73	24.56	18.01	21.69	1.42	0.42	24.79	12.97	2.16
5800	16.80	24.69	18.48	20.88	1.42	0.41	24.36	12.92	2.19
6000	16.86	24.71	19.27	20.96	1.42	0.41	23.72	12.47	2.26
6200	16.91	24.66	20.42	21.15	1.41	0.42	23.46	12.35	2.35
6400	17.02	24.72	21.67	20.89	1.41	0.42	23.27	12.20	2.35
6600	17.03	24.80	21.80	21.55	1.42	0.42	22.91	12.11	2.34
6800	17.19	24.33	23.93	19.13	1.35	0.45	22.62	11.92	2.34
7000	17.10	24.56	20.69	19.08	1.38	0.43	21.94	11.70	2.45

REV. X1  
GALI-39+  
070828

Page 6 of 11



IF/RF MICROWAVE COMPONENTS • ISO 9001 ISO 14001 AS 9100 CERTIFIED • RoHS compliant

P.O. Box 350166, Brooklyn, New York 11235-0003 (718) 934-4500 Fax (718) 332-4661



The Design Engineers Search Engine finds the model you need, Instantly • For detailed performance specs & shopping online see



## Typical Performance Data

### Definitions:

Input Return Loss = -S11 (dB)

Gain(Power Gain) = S21 (dB)

Reverse Isolation = -S12 (dB)

Output Return Loss = -S22 (dB)

TEST CONDITIONS: Icc = 35mA, Vd = 3.46V @Temperature = +85degC

FREQ	Gain	Isolation	Input Return Loss	Output Return Loss	Stability		IP3 Output	1dB Comp. Output	Noise Figure
					K	Delta			
(MHz)	(dB)	(dB)	(dB)	(dB)	K	Delta	(dBm)	(dBm)	(dB)
50	23.10	25.23	49.73	32.29	1.03	0.78	25.54	12.10	2.47
100	23.10	25.25	45.45	30.34	1.03	0.78	25.58	12.11	2.68
200	22.98	25.22	36.56	27.60	1.03	0.77	25.66	12.08	2.47
300	22.84	25.22	35.54	27.08	1.04	0.76	25.60	12.18	2.73
400	22.71	25.16	36.12	27.52	1.04	0.75	25.02	11.98	2.63
500	22.55	25.16	34.80	27.03	1.04	0.74	24.80	11.91	2.75
600	22.38	25.10	33.85	26.66	1.05	0.73	24.63	12.27	2.65
700	22.18	25.06	33.20	25.96	1.05	0.72	24.91	12.09	2.61
800	21.99	25.03	33.00	25.60	1.06	0.70	25.05	11.99	2.62
1000	21.60	24.97	31.75	25.31	1.07	0.68	25.02	11.67	2.64
1200	21.20	24.90	30.22	25.10	1.09	0.65	24.75	11.60	2.72
1400	20.79	24.81	28.21	24.97	1.10	0.63	24.41	11.67	2.80
1600	20.36	24.75	26.77	24.98	1.13	0.60	24.65	11.25	2.87
1800	19.96	24.68	24.95	24.86	1.14	0.58	25.03	11.27	2.76
2000	19.55	24.61	23.22	24.93	1.16	0.56	25.03	11.60	2.74
2200	19.17	24.57	22.13	25.68	1.19	0.53	24.96	11.88	2.86
2400	18.77	24.50	20.75	26.21	1.21	0.51	24.79	11.82	2.86
2600	18.41	24.49	19.74	27.18	1.24	0.49	24.60	11.77	2.85
2800	18.09	24.45	18.50	27.55	1.26	0.48	24.61	11.40	2.87
3000	17.78	24.39	17.36	27.26	1.28	0.46	24.71	11.48	2.91
3200	17.49	24.42	16.35	26.40	1.30	0.45	24.51	11.51	2.95
3400	17.21	24.37	15.55	25.24	1.32	0.44	24.38	11.65	3.06
3600	16.96	24.37	14.85	23.88	1.34	0.43	24.01	11.40	3.24
3800	16.71	24.43	14.28	22.76	1.37	0.41	23.67	11.40	3.25
4000	16.50	24.46	13.90	21.76	1.40	0.41	23.68	11.55	3.24
4200	16.30	24.52	13.73	21.20	1.43	0.40	23.68	11.76	3.14
4400	16.15	24.48	13.46	21.06	1.44	0.39	23.43	11.33	3.20
4600	15.98	24.53	13.67	21.24	1.47	0.39	23.18	11.25	3.31
4800	15.85	24.57	13.72	21.38	1.49	0.38	22.83	11.36	3.41
5000	15.78	24.60	13.75	21.74	1.51	0.38	22.50	11.33	3.34
5200	15.69	24.67	13.87	22.23	1.53	0.37	22.47	10.94	3.20
5400	15.65	24.80	14.10	22.02	1.56	0.36	22.15	10.69	3.24
5600	15.58	24.76	14.57	22.12	1.57	0.36	21.90	10.27	3.35
5800	15.57	24.87	14.65	21.58	1.58	0.36	21.48	10.12	3.46
6000	15.59	24.89	14.78	21.17	1.59	0.36	21.01	9.86	3.46
6200	15.55	24.83	14.97	21.37	1.59	0.36	20.78	9.55	3.51
6400	15.55	24.94	15.30	21.14	1.60	0.35	20.59	9.44	3.52
6600	15.42	24.91	15.34	21.26	1.62	0.35	20.24	9.64	3.56
6800	15.46	24.49	16.20	18.92	1.56	0.37	20.00	9.45	3.65
7000	15.21	24.66	15.49	18.79	1.61	0.36	19.72	9.24	3.76

## Typical Performance Data

### Definitions:

Input Return Loss = -S11 (dB)

Gain(Power Gain) = S21 (dB)

Reverse Isolation = -S12 (dB)

Output Return Loss = -S22 (dB)

TEST CONDITIONS: I<sub>cc</sub> = 28mA, V<sub>d</sub> = 3.44V @Temperature = +85degC

FREQ	Gain	Isolation	Input Return Loss	Output Return Loss	Stability		IP3 Output	1dB Comp. Output	Noise Figure
					K	Delta			
(MHz)	(dB)	(dB)	(dB)	(dB)	K	Delta	(dBm)	(dBm)	(dB)
50	22.34	24.56	23.41	26.55	1.03	0.78	22.51	9.15	2.43
100	22.36	24.60	23.81	27.27	1.03	0.77	22.52	9.20	2.59
200	22.27	24.57	25.26	29.02	1.03	0.77	22.60	9.12	2.52
300	22.13	24.56	24.76	28.81	1.04	0.76	22.54	8.97	2.66
400	22.01	24.55	24.29	27.70	1.04	0.75	22.02	9.02	2.67
500	21.88	24.49	23.16	27.48	1.04	0.74	21.85	9.06	2.68
600	21.73	24.46	23.63	27.50	1.05	0.73	21.76	9.04	2.67
700	21.52	24.42	23.49	28.06	1.05	0.72	22.09	9.22	2.56
800	21.37	24.40	23.33	28.23	1.06	0.70	22.28	8.84	2.65
1000	21.02	24.33	22.63	28.17	1.07	0.68	22.30	8.79	2.63
1200	20.65	24.28	22.25	28.36	1.08	0.66	22.01	8.32	2.71
1400	20.26	24.22	21.52	28.08	1.10	0.63	21.74	8.78	2.79
1600	19.83	24.23	21.16	28.60	1.12	0.60	22.02	8.61	2.81
1800	19.46	24.17	20.15	27.84	1.14	0.58	22.68	8.38	2.72
2000	19.09	24.11	19.13	26.97	1.15	0.56	22.74	8.80	2.70
2200	18.72	24.09	18.44	26.36	1.18	0.53	22.86	9.12	2.80
2400	18.33	24.06	17.50	25.39	1.20	0.51	22.95	9.11	2.82
2600	18.00	24.08	16.78	24.69	1.22	0.49	22.97	9.03	2.79
2800	17.67	24.08	15.82	23.85	1.25	0.47	23.17	8.65	2.84
3000	17.38	24.05	15.01	22.94	1.27	0.46	23.42	8.72	2.86
3200	17.08	24.12	14.29	21.63	1.29	0.44	23.36	8.71	2.94
3400	16.81	24.11	13.63	20.93	1.31	0.43	23.25	9.01	3.04
3600	16.56	24.14	13.13	20.14	1.34	0.42	23.07	8.93	3.22
3800	16.32	24.22	12.73	19.43	1.37	0.41	22.94	8.97	3.24
4000	16.13	24.26	12.41	18.78	1.39	0.40	23.07	9.15	3.21
4200	15.95	24.33	12.22	18.58	1.42	0.40	23.06	9.21	3.13
4400	15.79	24.33	12.10	18.55	1.44	0.39	22.92	8.96	3.17
4600	15.64	24.37	12.25	18.85	1.47	0.38	22.71	8.86	3.26
4800	15.51	24.43	12.36	19.02	1.50	0.38	22.42	9.20	3.35
5000	15.45	24.46	12.33	19.42	1.51	0.37	22.27	9.48	3.27
5200	15.36	24.55	12.52	19.92	1.54	0.36	22.32	9.25	3.14
5400	15.31	24.69	12.71	19.80	1.57	0.36	22.23	9.06	3.14
5600	15.25	24.63	12.96	20.17	1.57	0.36	22.09	8.60	3.26
5800	15.24	24.74	13.13	19.85	1.59	0.35	21.76	8.71	3.37
6000	15.25	24.77	13.20	19.62	1.60	0.36	21.32	8.42	3.37
6200	15.22	24.71	13.33	19.99	1.60	0.36	21.22	8.46	3.41
6400	15.21	24.78	13.47	19.84	1.61	0.35	20.92	8.60	3.41
6600	15.08	24.74	13.60	20.38	1.63	0.35	20.63	8.77	3.46
6800	15.10	24.31	14.25	18.58	1.57	0.37	20.46	8.59	3.56
7000	14.86	24.46	13.63	18.81	1.61	0.35	20.17	8.62	3.65

## Typical Performance Data

### Definitions:

Input Return Loss = -S11 (dB)

Gain(Power Gain) = S21 (dB)

Reverse Isolation = -S12 (dB)

Output Return Loss = -S22 (dB)

TEST CONDITIONS: Icc = 42mA, Vd = 3.48V @Temperature = +85degC

FREQ	Gain	Isolation	Input Return Loss	Output Return Loss	Stability		IP3 Output	1dB Comp. Output	Noise Figure
					K	Delta			
(MHz)	(dB)	(dB)	(dB)	(dB)	K	Delta	(dBm)	(dBm)	(dB)
50	23.53	25.66	27.48	23.11	1.03	0.79	28.17	13.92	2.48
100	23.51	25.68	26.56	22.36	1.03	0.78	28.25	13.80	2.74
200	23.38	25.67	24.91	21.16	1.03	0.77	28.27	13.96	2.45
300	23.27	25.64	25.48	21.37	1.04	0.77	28.09	13.65	2.79
400	23.11	25.60	26.29	21.57	1.04	0.75	27.45	13.58	2.62
500	22.96	25.56	26.97	21.71	1.04	0.74	27.02	13.64	2.78
600	22.74	25.51	26.70	21.31	1.05	0.73	26.74	13.69	2.64
700	22.58	25.47	27.25	21.36	1.05	0.72	26.84	13.55	2.66
800	22.38	25.43	27.43	21.25	1.06	0.71	26.82	13.57	2.66
1000	21.95	25.33	28.40	21.23	1.07	0.68	26.62	13.59	2.65
1200	21.53	25.25	29.05	21.25	1.09	0.65	26.29	13.20	2.76
1400	21.09	25.16	29.12	21.30	1.11	0.63	25.88	13.39	2.86
1600	20.66	25.08	29.14	21.57	1.13	0.60	25.99	13.21	2.90
1800	20.23	24.99	27.89	21.85	1.15	0.58	25.91	13.19	2.82
2000	19.82	24.88	26.45	22.20	1.17	0.56	25.85	13.42	2.79
2200	19.43	24.83	25.32	23.02	1.19	0.54	25.68	13.47	2.91
2400	19.03	24.75	23.59	24.02	1.21	0.52	25.31	13.39	2.91
2600	18.67	24.71	22.23	25.59	1.24	0.50	25.00	13.25	2.88
2800	18.34	24.64	20.63	27.29	1.26	0.48	24.85	13.16	2.92
3000	18.02	24.57	19.23	28.60	1.28	0.47	24.84	13.00	2.95
3200	17.71	24.57	17.94	29.88	1.31	0.45	24.55	13.05	3.02
3400	17.42	24.52	16.89	29.09	1.33	0.44	24.39	12.99	3.10
3600	17.18	24.50	16.07	27.26	1.35	0.43	23.99	12.95	3.28
3800	16.92	24.54	15.38	25.65	1.37	0.42	23.72	12.87	3.29
4000	16.70	24.56	14.98	24.11	1.40	0.41	23.57	12.94	3.27
4200	16.51	24.60	14.74	23.16	1.43	0.40	23.50	12.87	3.20
4400	16.35	24.56	14.44	22.89	1.44	0.40	23.33	12.69	3.23
4600	16.18	24.59	14.67	22.84	1.47	0.39	23.01	12.36	3.35
4800	16.04	24.64	14.69	22.95	1.49	0.38	22.57	12.28	3.46
5000	15.97	24.65	14.68	23.22	1.50	0.38	22.23	12.16	3.42
5200	15.89	24.73	14.88	23.66	1.52	0.37	22.17	11.67	3.27
5400	15.83	24.85	15.09	23.31	1.55	0.37	21.89	11.50	3.29
5600	15.77	24.81	15.60	23.14	1.56	0.36	21.61	11.01	3.43
5800	15.78	24.92	15.76	22.49	1.57	0.36	21.15	10.84	3.54
6000	15.77	24.95	15.94	21.93	1.58	0.36	20.58	10.30	3.57
6200	15.74	24.89	16.25	21.94	1.58	0.36	20.42	10.16	3.59
6400	15.73	25.01	16.57	21.65	1.60	0.36	20.24	9.88	3.60
6600	15.62	24.98	16.70	21.50	1.61	0.35	19.94	9.91	3.65
6800	15.66	24.56	17.77	18.97	1.55	0.37	19.70	9.76	3.77
7000	15.42	24.75	16.81	18.66	1.60	0.36	19.30	9.60	3.86

## Typical Performance Curves

**GAIN vs. TEMPERATURE**

INPUT POWER = -25dBm, CURRENT = 35mA

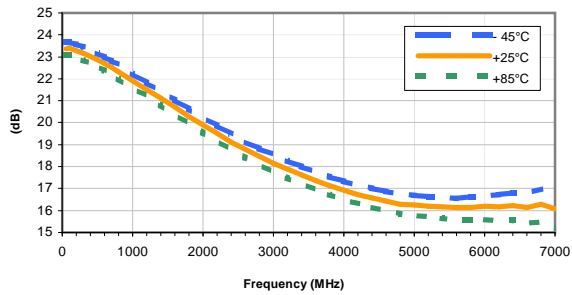

**GAIN vs. CURRENT**

INPUT POWER = -25dBm, Temperature = +25°C

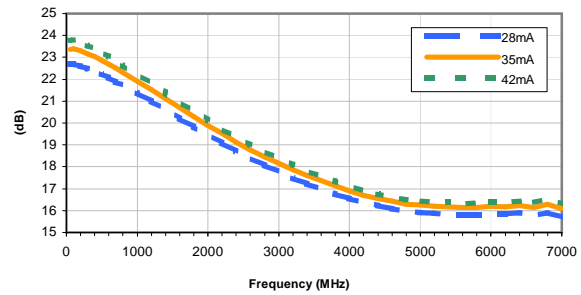

**ISOLATION vs. TEMPERATURE**

INPUT POWER = -25dBm, CURRENT = 35mA

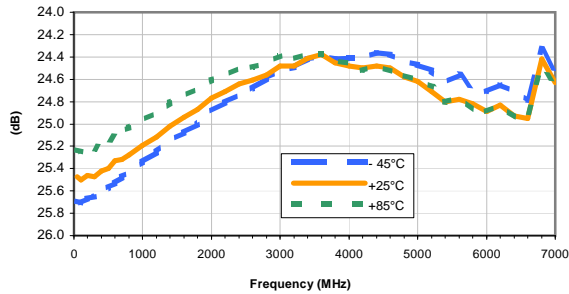

**ISOLATION vs. CURRENT**

INPUT POWER = -25dBm, Temperature = +25°C

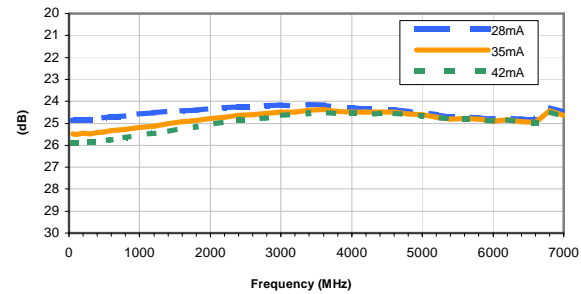

**INPUT RETURN LOSS vs. TEMPERATURE**

INPUT POWER = -25dBm, CURRENT = 35mA

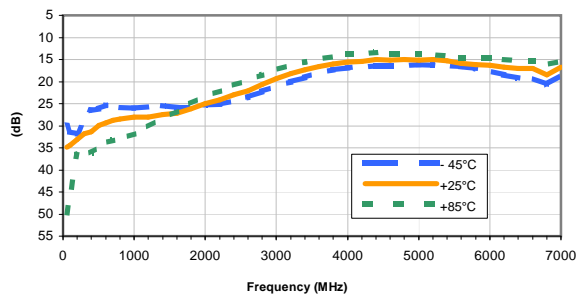

**INPUT RETURN LOSS vs. CURRENT**

INPUT POWER = -25dBm, Temperature = +25°C

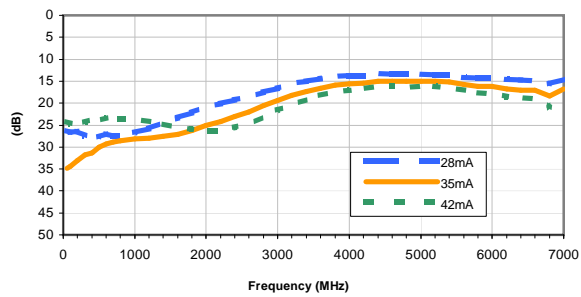

**OUTPUT RETURN LOSS vs. TEMPERATURE**

INPUT POWER = -25dBm, CURRENT = 35mA

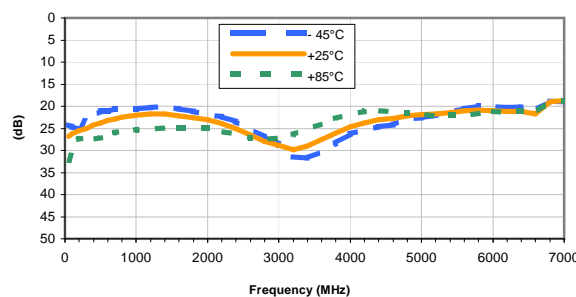

**OUTPUT RETURN LOSS vs. CURRENT**

INPUT POWER = -25dBm, Temperature = +25°C

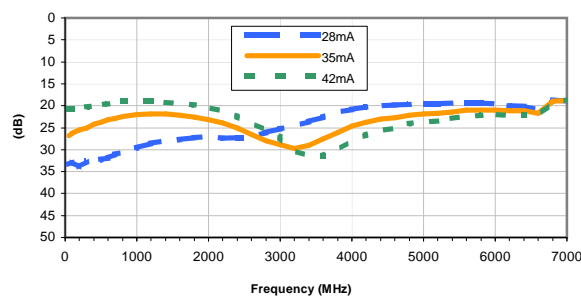

## Typical Performance Curves

**OUTPUT IP3 vs. TEMPERATURE**

INPUT POWER = -25dBm, CURRENT = 35mA

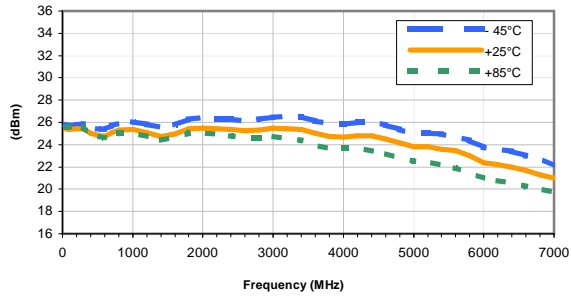

**OUTPUT IP3 vs. CURRENT**

INPUT POWER = -25dBm, Temperature = +25°C

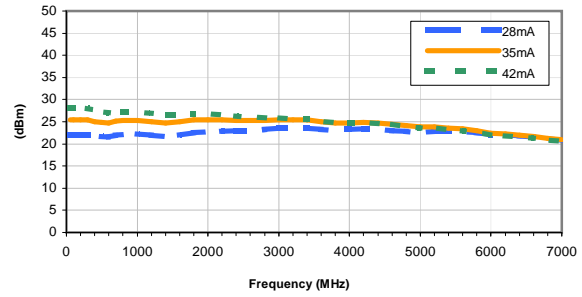

**OUTPUT POWER at 1dB Compression vs. TEMPERATURE**

CURRENT = 35mA

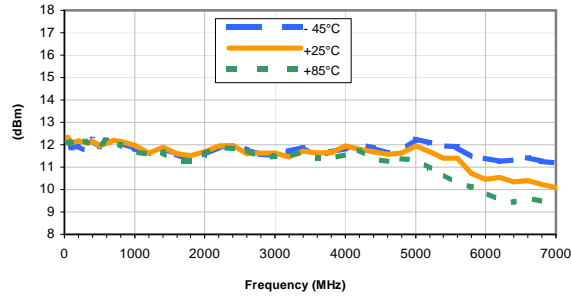

**OUTPUT POWER at 1dB Compression vs. CURRENT**

Temperature = +25°C

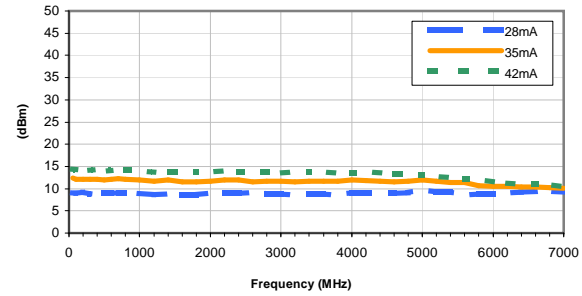

**Noise Figure vs. TEMPERATURE**

CURRENT = 35mA

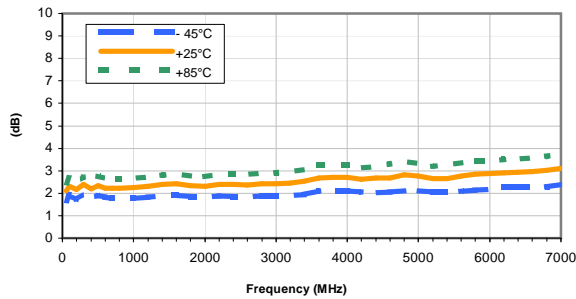

**Noise Figure vs. CURRENT**

Temperature = +25°C

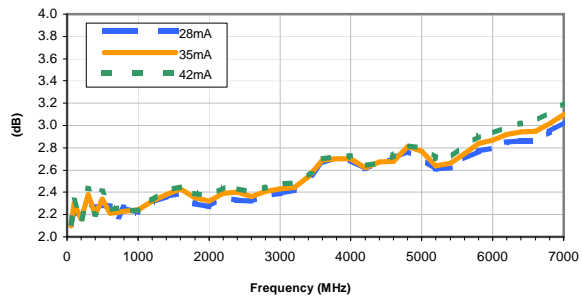



## Typical Performance Curves

**GAIN vs. TEMPERATURE**

INPUT POWER = -25dBm, CURRENT = 35mA

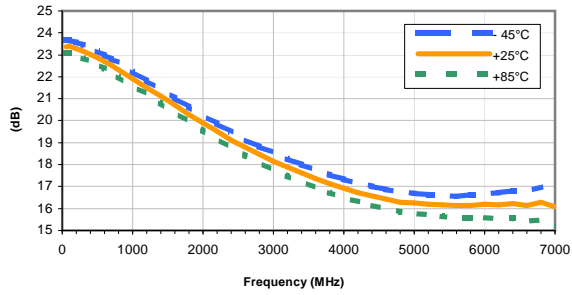

**GAIN vs. CURRENT**

INPUT POWER = -25dBm, Temperature = +25°C

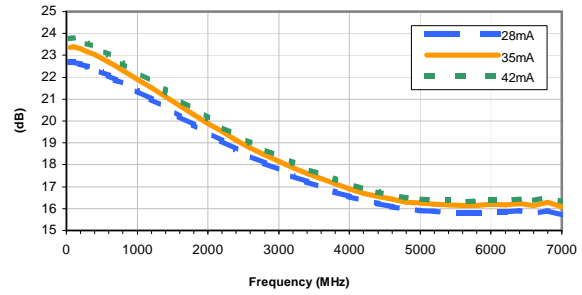

**ISOLATION vs. TEMPERATURE**

INPUT POWER = -25dBm, CURRENT = 35mA

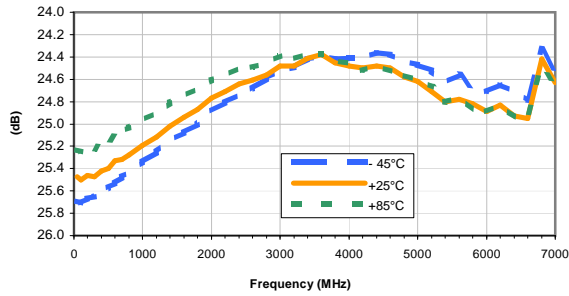

**ISOLATION vs. CURRENT**

INPUT POWER = -25dBm, Temperature = +25°C

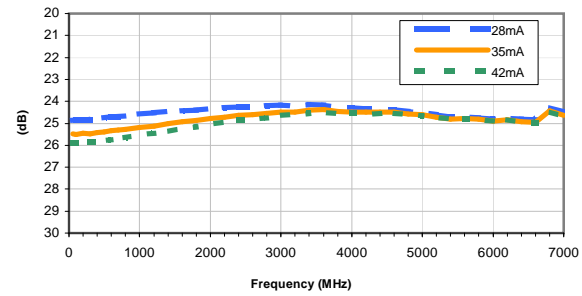

**INPUT RETURN LOSS vs. TEMPERATURE**

INPUT POWER = -25dBm, CURRENT = 35mA

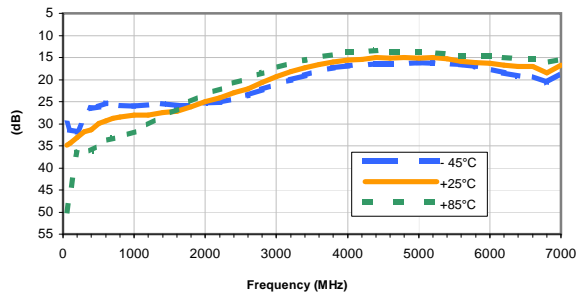

**INPUT RETURN LOSS vs. CURRENT**

INPUT POWER = -25dBm, Temperature = +25°C

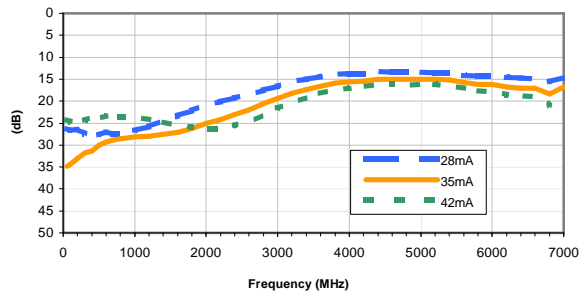

**OUTPUT RETURN LOSS vs. TEMPERATURE**

INPUT POWER = -25dBm, CURRENT = 35mA

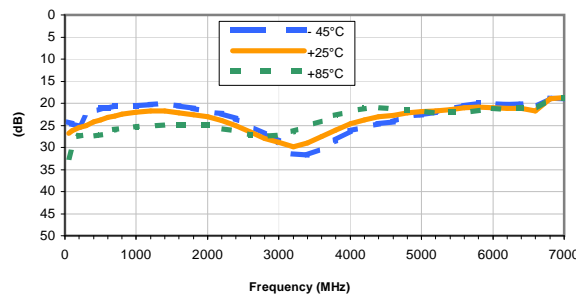

**OUTPUT RETURN LOSS vs. CURRENT**

INPUT POWER = -25dBm, Temperature = +25°C

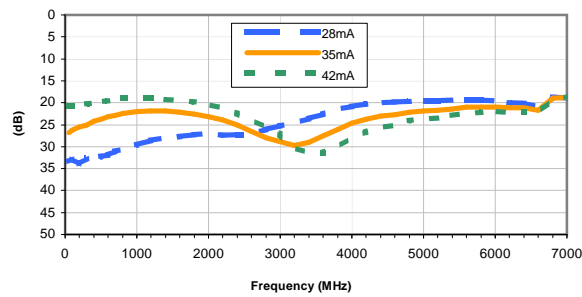



## Typical Performance Curves

**OUTPUT IP3 vs. TEMPERATURE**

INPUT POWER = -25dBm, CURRENT = 35mA

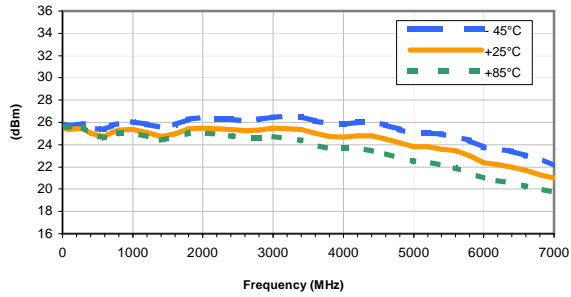

**OUTPUT IP3 vs. CURRENT**

INPUT POWER = -25dBm, Temperature = +25°C

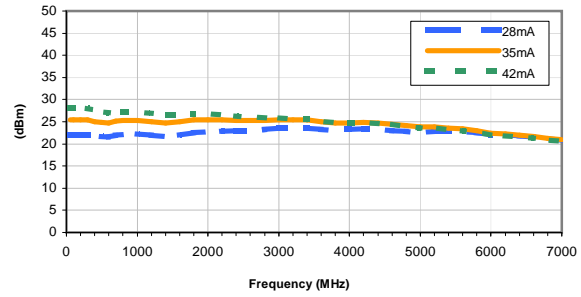

**OUTPUT POWER at 1dB Compression vs. TEMPERATURE**

CURRENT = 35mA

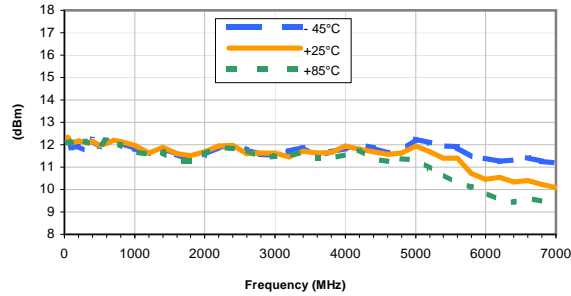

**OUTPUT POWER at 1dB Compression vs. CURRENT**

Temperature = +25°C

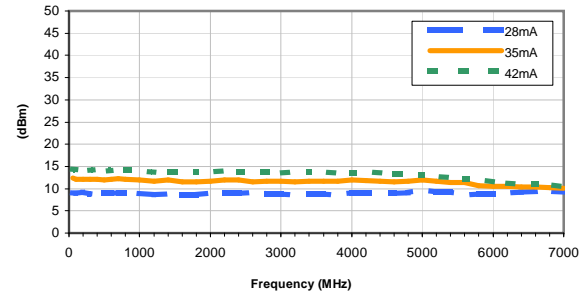

**Noise Figure vs. TEMPERATURE**

CURRENT = 35mA

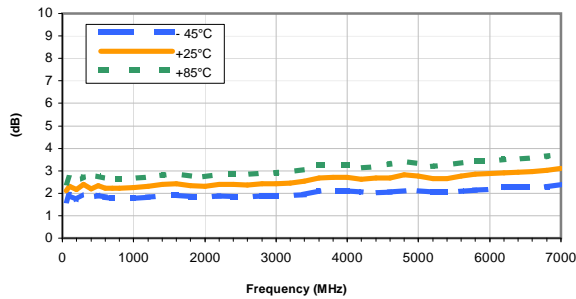

**Noise Figure vs. CURRENT**

Temperature = +25°C

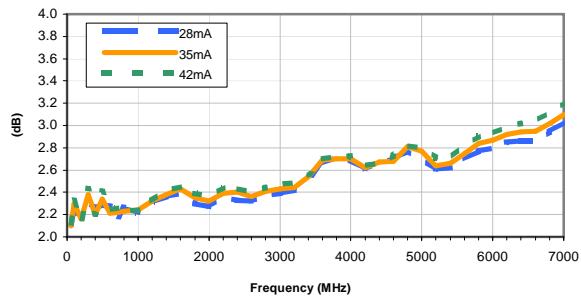

### Outline Dimensions



### PCB Land Pattern

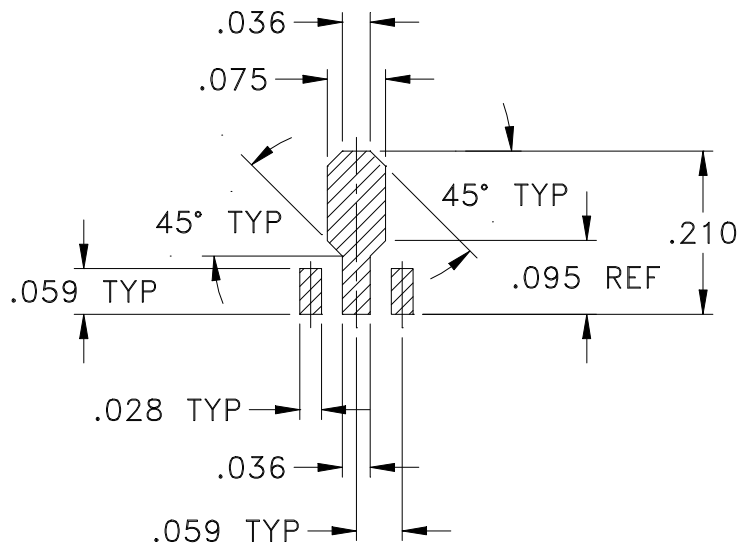

Suggested Layout,  
Tolerance to be within  $\pm .002$

CASE #	A	B	C	D	E	F	G	H	J	K	L	M
DF782	.102 (2.59)	.090 (2.29)	.181 (4.60)	.173 (4.39)	.063 (1.60)	.167 (4.24)	.155 (3.94)	.059 (1.50)	.118 (3.00)	.015 (0.38)	.041 (1.04)	.016 (0.41)

CASE #	N	P	Q	WT. GRAM
DF782	.019 (0.48)	.065 (1.65)	.062 (1.57)	.2

Dimensions are in inches (mm). Tolerances: 2 Pl.  $\pm .01$ ; 3Pl.  $\pm .005$

#### Notes:

- Case material: Plastic.
- Termination finish:  
 For RoHS Case Styles: Tin-Silver alloy plate over Nickel barrier or Matte-Tin.  
 All models, (+) suffix. See model Data sheet.  
 For RoHS-5 Case Styles: Tin-Lead plate. All models, no (+) suffix.



INTERNET <http://www.minicircuits.com>

P.O. Box 350166, Brooklyn, New York 11235-0003 (718) 934-4500 Fax (718) 332-4661

Distribution Centers NORTH AMERICA 800-654-7949 • 417-335-5935 • Fax 417-335-5945 • EUROPE 44-1252-832600 • Fax 44-1252-837010

Mini-Circuits ISO 9001 & ISO 14001 Certified

# Tape & Reel Packaging TR-F55

## DEVICE ORIENTATION IN T&R



Tape Width, mm	Device Cavity Pitch, mm	Reel Size, inches	Devices per Reel	
12	8	7	Small quantity standard (see note)	20
				50
				100
				200
				500
			Standard	1000

Note: Please consult individual model data sheet to determine device per reel availability.

Mini-Circuits carrier tape materials provide protection from ESD (Electro-Static Discharge) during handling and transportation. Tapes are static dissipative and comply with industry standards EIA-481/EIA-541.

Go to: [www.minicircuits.com/pages/pdfs/tape.pdf](http://www.minicircuits.com/pages/pdfs/tape.pdf)



INTERNET <http://www.minicircuits.com>

P.O. Box 350166, Brooklyn, New York 11235-0003 (718) 934-4500 Fax (718) 332-4661

Distribution Centers NORTH AMERICA 800-654-7949 • 417-335-5935 • Fax 417-335-5945 • EUROPE 44-1252-832600 • Fax 44-1252-837010

Mini-Circuits ISO 9001 & ISO 14001 Certified

THIRD ANGLE PROJECTION



REVISIONS

REV	ECN No.	DESCRIPTION	DATE	DR	AUTH
A	M76190	CHANGED DISCRIPTION	04/01	GF	CT
B	M82575	UPDATED DRAWING	08/05/02	AV	LC
C	M102713	ADDED NOTE 2 & "...WITH SMOBC"	01/17/06	MMG	IL
D	M108434	UPDATED DRAWING PER TB-409+	11/14/06	PW	IG

SUGGESTED MOUNTING CONFIGURATION  
FOR DF782 CASE STYLE, "mz" PIN CONNECTION



- NOTES:** 1. TRACE WIDTH IS SHOWN FOR ROGERS R04350B WITH DIELECTRIC THICKNESS .030" ± .002"; COPPER: 1/2 OZ. EACH SIDE. FOR OTHER MATERIALS TRACE WIDTH MAY NEED TO BE MODIFIED.  
2. BOTTOM SIDE OF THE PCB IS CONTINUOUS GROUND PLANE.



DENOTES PCB COPPER LAYOUT WITH SMOBC (SOLDER MASK OVER BARE COPPER)



DENOTES COPPER LAND PATTERN FREE OF SOLDER MASK

UNLESS OTHERWISE SPECIFIED	INITIALS	DATE
DIMENSIONS ARE IN INCHES	DRAWN AV	01/15/01
TOLERANCES ON:	CHECKED YB	01/23/01
2 PL DECIMALS ±	APPROVED DB	01/23/01
3 PL DECIMALS ± .005		
ANGLES ±		
FRACTIONS ±		

 **Mini-Circuits®** 13 Neptune Avenue  
Brooklyn NY 11235

PL, mz, DF782, GALI, TB-409-XXX+

 Mini-Circuits®  
THIS DOCUMENT AND ITS CONTENTS ARE THE PROPERTY OF MINI-CIRCUITS. EXCEPT FOR USE EXPRESSLY GRANTED, IN WRITING, TO ITS VENDORS, VENDEE AND THE UNITED STATES GOVERNMENT, MINI-CIRCUITS RESERVES ALL PROPRIETARY DESIGN, USE, MANUFACTURING AND REPRODUCTION RIGHTS THERETO. THESE CONTENTS SHALL NOT BE USED, DUPLICATED OR DISCLOSED TO ANY OUTSIDE PARTY, IN WHOLE OR IN PART, WITHOUT WRITTEN PERMISSION OF MINI-CIRCUITS.

SIZE	CODE IDENT	DRAWING NO:	REV:
A	15542	98-PL-019	D
FILE:	98PL019	SCALE: 10:1	SHEET: 1 OF 1

# Evaluation Board and Circuit

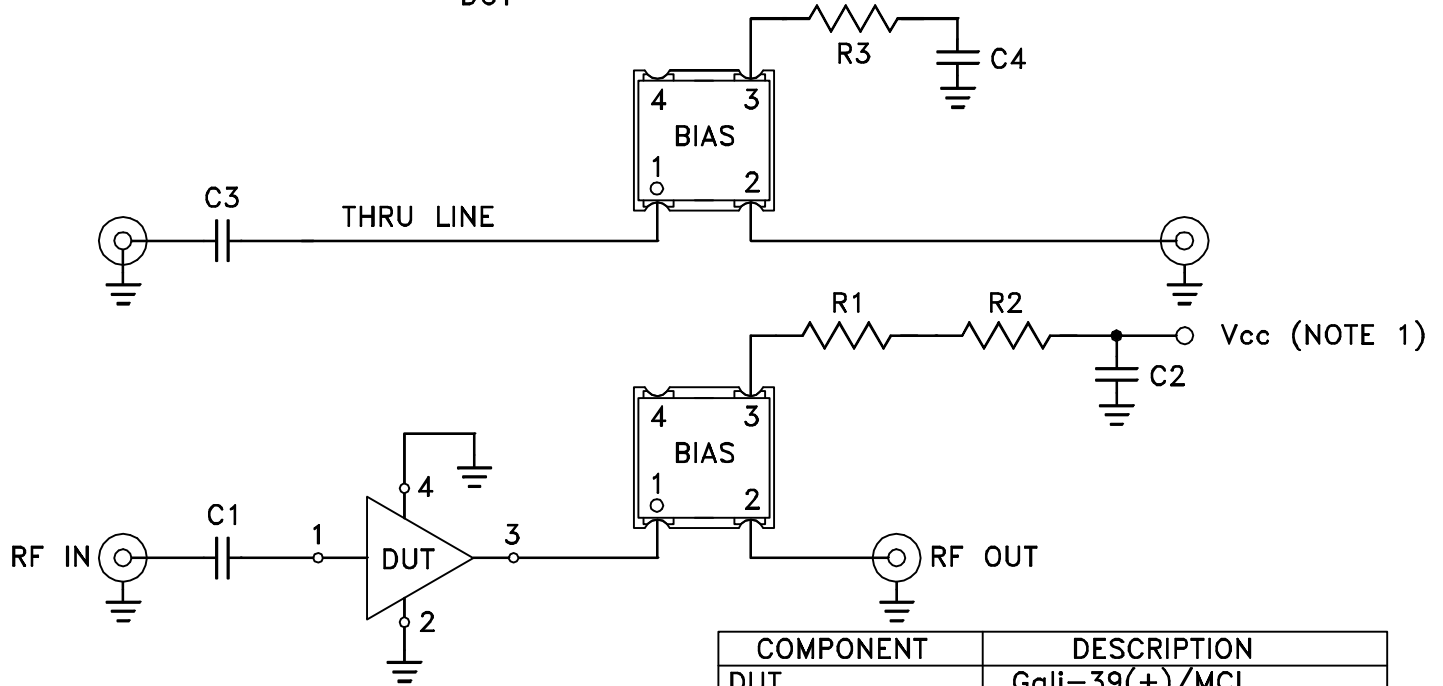
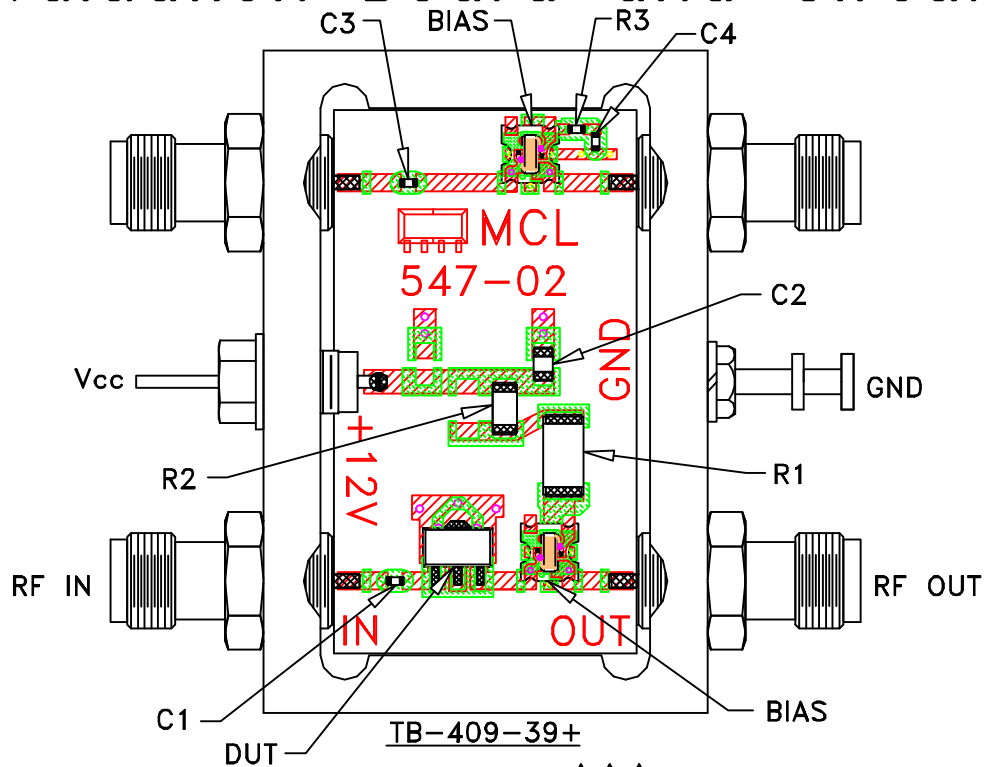

COMPONENT	DESCRIPTION
DUT	Gali-39(+)/MCL
C1,C3,C4	0.001 uF
C2 (bypass)	0.1 uF
R1	243 Ohms
R2	0 Ohm
R3	237 Ohms
BIAS TEE	Mini-Circuits TCBT-14+

## NOTES:

1. Vcc voltage:  $+12 \pm 0.2V$ .
2. SMA Female connectors.
3. PCB material: Rogers R04350 or equivalent, dielectric constant=3.5, dielectric thickness=.020 inch.

## Schematic Diagram

 **Mini-Circuits®**

All Mini-Circuits products are manufactured under exacting quality assurance and control standards, and are capable of meeting published specifications after being subjected to any or all of the following physical and environmental test.

Specification	Test/Inspection Condition	Reference/Spec
Operating Temperature	-45° to 85°C or -40° to 85°C Ambient Environment	Individual Model Data Sheet
Storage Temperature	-65° to 150° C Ambient Environment	Individual Model Data Sheet
Thermal Shock	-55° to 100°C, 100 cycles	MIL-STD-202, Method 107, Condition A-3, except +100°C
Mechanical Shock	1.5Kg, 0.5 ms, 5 shock pulses, Y1 direction only	MIL-STD-883, Method 2002, Condition B, except Y1 direction only
Vibration (Variable Frequency)	50g peak	MIL-STD-883, Method 2007, Condition B
Autoclave	15 psig, 100% RH, 121°C, 96 hours	JESD22-A102, Condition C
HAST	130°C, 85% RH, 96 hours	JESD22-A110
Solderability	10X Magnification	J-STD-002, Para 4.2.5, Test S, 95% Coverage
Solder Reflow Heat	Sn-Pb Eutetic Process: 240°C peak Pb-Free Process: 260°C peak	J-STD-020, Table 4-1, 4-2 and 5-2; Figure 5-1
Moisture Sensitivity: Level 1	Bake at 125°C for 24 hours Soak at 85°C/85% RH for 168 hours, Reflow 3 cycles at 260°C peak	J-STD-020
Marking Resistance to Solvents	Isopropyl alcohol + mineral spirits at 25°C; terpene defluxer at 25°C; distilled water + proylene glycol monomethyl ether +	MIL-STD-202, Method 215



All Mini-Circuits products are manufactured under exacting quality assurance and control standards, and are capable of meeting published specifications after being subjected to any or all of the following physical and environmental test.

<b>Specification</b>	<b>Test/Inspection Condition</b>	<b>Reference/Spec</b>
	monoethanolamine at 63°C to 70°C	