

Surface Mount Frequency Mixer

NON-CATALOG

LRMS-1H

Level 17 (LO Power +17dBm) 2 to 500 MHz



Generic photo used for illustration purposes only
CASE STYLE: QQQ130

Maximum Ratings

Operating Temperature	-40°C to 85°C
Storage Temperature	-55°C to 100°C
RF Power	200mW
IF Current	40mA
Permanent damage may occur if any of these limits are exceeded.	

Pin Connections

LO	1
RF	4
IF	5
GROUND	2,3,6

Features

- low conversion loss, 6.25 dB typ.
- excellent L-R isolation, 44 dB typ.

Applications

- HF/VHF/UHF
- instrumentation

Outline Drawing

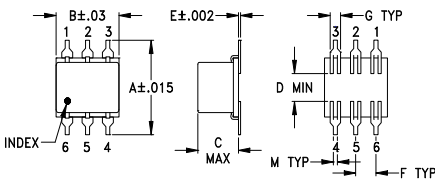

PCB Land Pattern

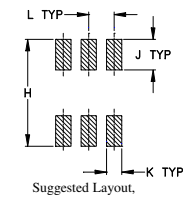

Outline Dimensions (inch/mm)

A	B	C	D	E	F	G
.400	.31	.200	.10	.010	.100	.050
10.16	7.87	5.08	2.54	0.25	2.54	1.27
H	J	K	L	M	wt	
.420	.120	.060	.100	.020	grams	
10.67	3.05	1.52	2.54	0.51	0.55	

Demo Board MCL P/N: TB-44+ Suggested PCB Layout (PL-083)

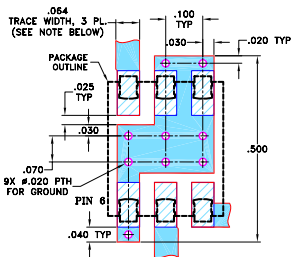

- NOTES: 1. TRACE WIDTH IS SHOWN FOR ROGERS R04350B WITH DIELECTRIC THICKNESS 0.030" ± 0.002"; COPPER: 1/2 OZ. EACH SIDE. FOR OTHER MATERIALS TRACE WIDTH MAY NEED TO BE MODIFIED.
2. BOTTOM SIDE OF THE PCB IS CONTINUOUS GROUND PLANE.
- DENOTES PCB COPPER LAYOUT WITH SMOBC (SOLDER MASK OVER BARE COPPER)
 - DENOTES COPPER LAND PATTERN FREE OF SOLDER MASK

Notes

- A. Performance and quality attributes and conditions not expressly stated in this specification document are intended to be excluded and do not form a part of this specification document.
- B. Electrical specifications and performance data contained in this specification document are based on Mini-Circuit's applicable established test performance criteria and measurement instructions.
- C. The parts covered by this specification document are subject to Mini-Circuits standard limited warranty and terms and conditions (collectively, "Standard Terms"); Purchasers of this part are entitled to the rights and benefits contained therein. For a full statement of the Standard Terms and the exclusive rights and remedies thereunder, please visit Mini-Circuits' website at www.minicircuits.com/MCLStore/terms.jsp

Electrical Specifications

FREQUENCY (MHz)	CONVERSION LOSS (dB)	LO-RF ISOLATION (dB)			LO-IF ISOLATION (dB)			IP3 at center band (dBm)						
		L	M	U	L	M	U							
2-500	DC-500	55	44	44	25	33	20	50	34	45	25	37	22	25

1 dB COMP.: +14 dBm typ.

L = low range [f_1 to $10 f_1$]
m = mid band [$2 f_1$ to $f_1/2$]

M = mid range [$10 f_1$ to $f_1/2$]

U = upper range [$f_1/2$ to f_1]

Typical Performance Data

Frequency (MHz)		Conversion Loss (dB)	Isolation L-R (dB)	Isolation L-I (dB)	VSWR RF Port (:1)	VSWR LO Port (:1)
RF	LO	LO +17dBm	LO +17dBm	LO +17dBm	LO +17dBm	LO +17dBm
2.00	32.00	6.78	79.29	69.19	1.33	1.77
4.00	34.00	6.60	72.35	63.39	1.20	1.75
5.00	35.00	6.57	71.51	62.98	1.15	1.82
10.00	40.00	6.55	65.84	61.30	1.14	1.82
20.00	50.00	6.48	59.50	58.68	1.13	1.75
35.20	65.20	6.36	51.64	53.67	1.14	1.75
50.00	80.00	6.53	51.61	53.63	1.14	1.76
85.00	55.00	6.47	45.13	48.67	1.15	1.74
100.00	70.00	6.48	44.98	48.52	1.17	1.71
134.80	104.80	6.32	41.19	46.50	1.19	1.69
184.60	154.60	6.35	38.78	44.90	1.22	1.65
200.00	170.00	6.40	38.62	44.42	1.23	1.62
234.40	204.40	6.30	36.44	41.20	1.24	1.63
250.00	220.00	6.22	36.14	41.01	1.26	1.62
284.20	254.20	6.22	35.11	38.57	1.30	1.58
334.00	304.00	6.18	33.38	37.07	1.34	1.54
383.80	353.80	6.11	32.33	33.77	1.39	1.51
433.60	403.60	6.16	32.22	31.10	1.44	1.45
483.40	453.40	6.45	31.29	29.09	1.47	1.41
500.00	470.00	6.45	30.80	28.30	1.49	1.39

Electrical Schematic

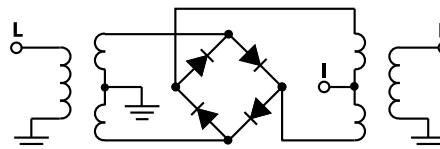

Performance Charts

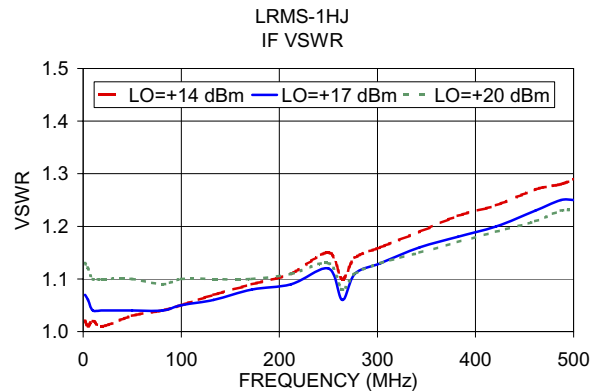
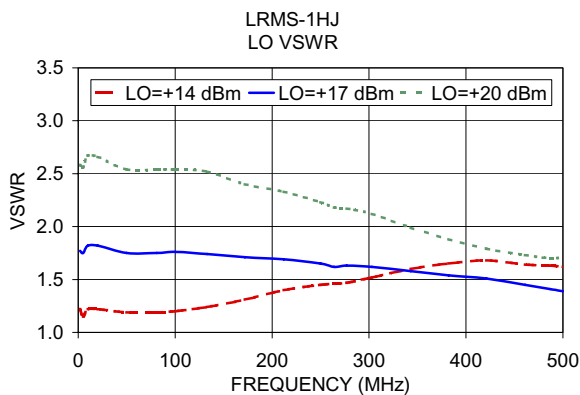
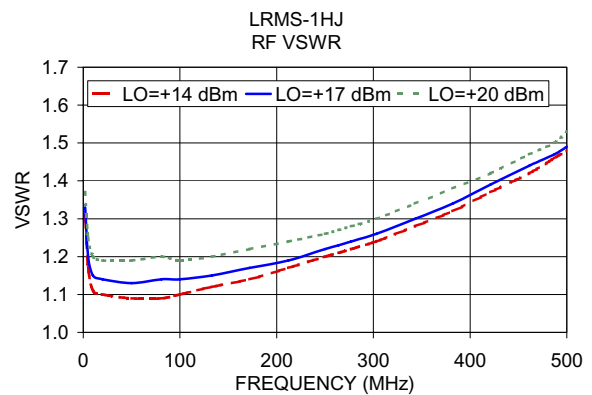
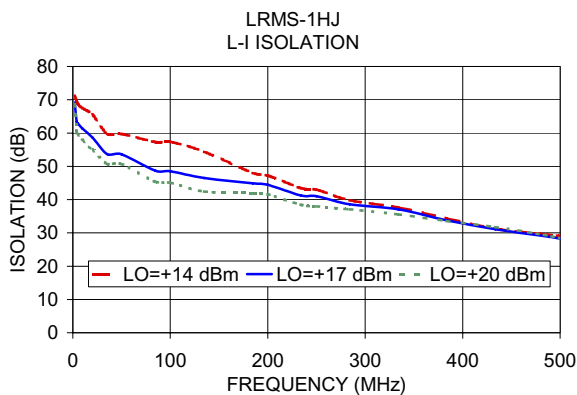
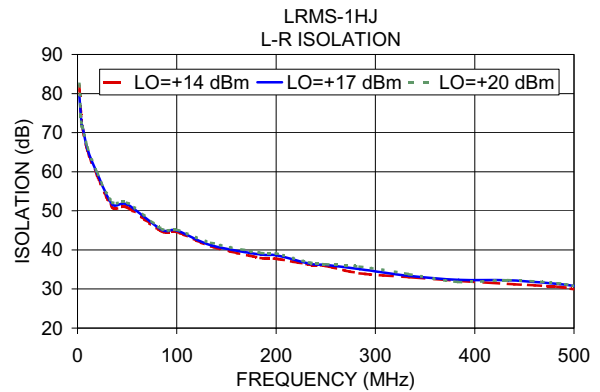
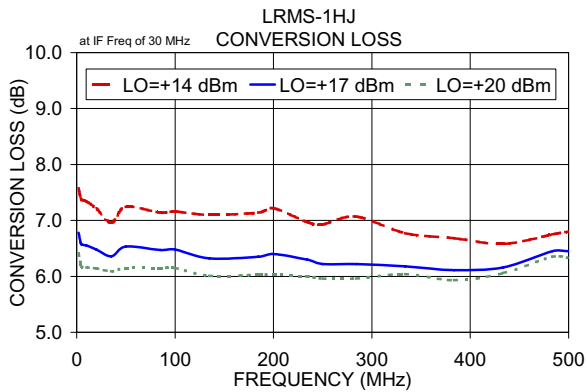

Notes

- A. Performance and quality attributes and conditions not expressly stated in this specification document are intended to be excluded and do not form a part of this specification document.
- B. Electrical specifications and performance data contained in this specification document are based on Mini-Circuit's applicable established test performance criteria and measurement instructions.
- C. The parts covered by this specification document are subject to Mini-Circuits standard limited warranty and terms and conditions (collectively, "Standard Terms"); Purchasers of this part are entitled to the rights and benefits contained therein. For a full statement of the Standard Terms and the exclusive rights and remedies thereunder, please visit Mini-Circuits' website at www.minicircuits.com/MCLStore/terms.jsp

Frequency Mixer

LRMS-1H+

Typical Performance Data

RF (IN) (MHz)	LO (MHz)	CONVERSION LOSS IF FIXED @IF(OUT)=30MHz (dB)			RF (IN) (MHz)	LO (MHz)	IP3 INPUT (dBm)			RF (IN) (MHz)	LO (MHz)	COMPRESSION @RF IN=+14dBm (dB)		
		@LO (dBm)					@LO (dBm)					@LO (dBm)		
		+14	+17	+20			+14	+17	+20			+14	+17	+20
2.0	32.0	7.57	6.78	6.41	10.1	40.1	26.27	29.17	33.94	10.1	40.1	1.05	0.63	0.42
5.0	35.0	7.37	6.57	6.17	49.8	79.8	25.90	28.15	32.43	49.8	79.8	0.88	0.51	0.32
10.0	40.0	7.34	6.55	6.16	89.5	119.5	25.53	28.19	28.59	89.5	119.5	0.79	0.46	0.29
49.8	79.8	6.85	6.30	6.01	129.2	159.2	27.42	28.63	33.48	129.2	159.2	0.82	0.50	0.29
89.5	119.5	6.86	6.25	5.98	168.9	198.9	26.79	27.37	34.62	168.9	198.9	0.78	0.46	0.26
129.2	159.2	6.76	6.20	5.97	208.6	238.6	28.95	30.44	29.13	208.6	238.6	0.90	0.48	0.26
168.9	198.9	6.75	6.20	5.99	248.3	278.3	24.27	30.03	26.53	248.3	278.3	0.86	0.47	0.29
208.6	238.6	6.61	6.14	5.97	287.9	317.9	26.48	29.77	27.63	287.9	317.9	0.98	0.44	0.26
248.3	278.3	6.76	6.26	6.05	327.6	357.6	29.58	27.50	26.55	327.6	357.6	0.95	0.44	0.27
287.9	317.9	6.60	6.20	6.05	367.3	397.3	29.37	25.02	24.49	367.3	397.3	0.98	0.48	0.32
327.6	357.6	6.66	6.26	6.11	407.0	437.0	24.87	22.68	22.92	407.0	437.0	0.86	0.44	0.30
367.3	397.3	6.63	6.23	6.07	446.7	476.7	24.92	22.70	22.95	446.7	476.7	0.87	0.41	0.30
446.7	476.7	6.85	6.45	6.20	486.4	516.4	25.89	24.36	25.96	486.4	516.4	0.97	0.47	0.34
486.4	516.4	6.82	6.44	6.19	526.1	556.1	27.08	25.40	26.28	526.1	556.1	1.08	0.56	0.38
526.1	556.1	6.88	6.51	6.26	565.8	595.8	28.45	26.38	26.86	565.8	595.8	1.22	0.68	0.47
565.8	595.8	6.83	6.44	6.23	585.6	615.6	25.20	24.68	25.57	585.6	615.6	1.17	0.66	0.47
585.6	615.6	6.87	6.46	6.24	625.3	655.3	21.39	22.60	24.13	625.3	655.3	1.37	0.79	0.50
625.3	655.3	6.87	6.48	6.29	645.2	675.2	21.11	21.64	22.92	645.2	675.2	1.32	0.80	0.51
645.2	675.2	6.95	6.56	6.34	684.9	714.9	18.44	19.80	22.05	684.9	714.9	1.36	0.85	0.54
684.9	714.9	7.05	6.64	6.44	704.7	734.7	17.14	18.51	20.72	704.7	734.7	1.47	0.99	0.63
744.4	774.4	7.43	6.96	6.66	764.3	794.3	15.05	16.32	19.15	764.3	794.3	1.41	1.07	0.77
764.3	794.3	7.54	7.03	6.71	803.9	833.9	14.40	15.39	18.51	803.9	833.9	1.37	1.02	0.76
803.9	833.9	7.86	7.32	6.88	823.8	853.8	14.53	15.20	17.92	823.8	853.8	1.36	1.02	0.82
823.8	853.8	8.03	7.44	6.97	863.5	893.5	14.26	14.91	16.76	863.5	893.5	1.15	0.88	0.73
863.5	893.5	8.42	7.74	7.21	883.3	913.3	14.51	15.06	16.60	883.3	913.3	1.15	0.88	0.74
883.3	913.3	8.55	7.88	7.29	923.0	953.0	15.07	16.35	18.12	923.0	953.0	0.84	0.68	0.62
923.0	953.0	9.03	8.24	7.58	942.9	972.9	15.67	17.68	20.05	942.9	972.9	0.71	0.66	0.63
942.9	972.9	9.19	8.31	7.62	982.6	1012.6	16.97	20.40	24.05	982.6	1012.6	0.59	0.68	0.72
982.6	1012.6	9.49	8.39	7.64	1002.4	1032.4	17.57	21.37	24.41	1002.4	1032.4	0.53	0.70	0.75
1002.4	1032.4	9.63	8.46	7.69	1042.1	1072.1	17.99	21.33	23.43	1042.1	1072.1	0.52	0.80	0.83
1042.1	1072.1	9.79	8.51	7.75	1061.9	1091.9	18.01	20.99	22.67	1061.9	1091.9	0.43	0.75	0.84
1061.9	1091.9	9.93	8.63	7.85	1101.6	1131.6	17.84	19.68	20.74	1101.6	1131.6	0.44	0.77	0.85
1101.6	1131.6	10.12	8.83	8.04	1121.5	1151.5	17.58	19.18	20.24	1121.5	1151.5	0.47	0.77	0.86
1121.5	1151.5	10.22	8.93	8.11	1161.2	1191.2	17.91	18.81	20.25	1161.2	1191.2	0.59	0.76	0.88
1181.0	1211.0	10.36	9.26	8.51	1181.0	1211.0	17.66	18.80	20.55	1181.0	1211.0	0.61	0.76	0.87
1220.7	1250.7	10.54	9.59	8.91	1220.7	1250.7	18.49	19.55	21.48	1220.7	1250.7	0.71	0.80	0.89
1240.6	1270.6	10.58	9.70	9.05	1240.6	1270.6	18.99	20.04	22.35	1240.6	1270.6	0.76	0.77	0.89
1280.3	1310.3	10.90	10.19	9.63	1280.3	1310.3	20.27	22.10	24.51	1280.3	1310.3	0.75	0.68	0.78
1300.1	1330.1	11.03	10.35	9.85	1300.1	1330.1	21.24	22.92	25.88	1300.1	1330.1	0.82	0.65	0.72

Frequency Mixer

LRMS-1H+

Typical Performance Data

IF (OUT) (MHz)	LO (MHz)	CONVERSION LOSS VS. IF FREQUENCY @RF(IN)=250.1MHz (dB)	IF (OUT) (MHz)	LO (MHz)	CONVERSION LOSS VS. IF FREQUENCY @RF(IN)=10.1MHz (dB)	IF (OUT) (MHz)	LO (MHz)	CONVERSION LOSS VS. IF FREQUENCY @RF(IN)=500.1MHz (dB)
		@LO (dBm)			@LO (dBm)			@LO (dBm)
		+17			+17			+17
240.0	10.1	6.30	10.0	20.1	6.02	490.0	10.1	6.45
234.1	16.0	6.32	22.3	32.4	5.97	477.7	22.4	6.40
228.2	21.9	6.20	34.6	44.7	5.96	465.4	34.7	6.36
222.3	27.8	6.25	46.9	57.0	5.94	453.1	47.0	6.41
216.4	33.7	6.23	59.2	69.3	5.89	440.8	59.3	6.44
210.5	39.6	6.19	71.5	81.6	5.94	428.5	71.6	6.33
204.6	45.5	6.26	83.8	93.9	6.02	416.2	83.9	6.32
198.7	51.4	6.19	96.2	106.3	5.94	403.8	96.3	6.26
192.8	57.3	6.17	108.5	118.6	5.92	391.5	108.6	6.22
186.9	63.2	6.22	120.8	130.9	5.88	379.2	120.9	6.23
181.0	69.1	6.17	133.1	143.2	5.85	366.9	133.2	6.10
175.1	75.0	6.29	145.4	155.5	5.97	354.6	145.5	6.05
169.2	80.9	6.20	157.7	167.8	6.00	342.3	157.8	6.08
163.3	86.8	6.18	170.0	180.1	5.95	330.0	170.1	6.08
157.4	92.7	6.26	182.3	192.4	5.96	317.7	182.4	6.03
151.5	98.6	6.14	194.6	204.7	5.99	305.4	194.7	6.00
145.6	104.5	6.19	206.9	217.0	6.00	293.1	207.0	5.95
139.7	110.4	6.20	219.2	229.3	6.03	280.8	219.3	5.93
133.8	116.3	6.11	231.5	241.6	5.98	268.5	231.6	6.00
127.9	122.2	6.12	243.8	253.9	5.98	256.2	243.9	5.99
122.1	128.0	6.05	256.2	266.3	6.07	243.8	256.3	6.02
116.2	133.9	6.04	268.5	278.6	6.11	231.5	268.6	6.06
110.3	139.8	6.14	280.8	290.9	6.08	219.2	280.9	6.02
104.4	145.7	6.08	293.1	303.2	6.10	206.9	293.2	6.04
98.5	151.6	6.11	305.4	315.5	6.05	194.6	305.5	6.04
92.6	157.5	6.08	317.7	327.8	6.10	182.3	317.8	5.99
86.7	163.4	6.04	330.0	340.1	6.17	170.0	330.1	6.02
80.8	169.3	6.10	342.3	352.4	6.12	157.7	342.4	6.05
74.9	175.2	6.09	354.6	364.7	6.15	145.4	354.7	6.06
69.0	181.1	6.09	366.9	377.0	6.18	133.1	367.0	6.14
63.1	187.0	6.08	379.2	389.3	6.17	120.8	379.3	6.13
57.2	192.9	6.04	391.5	401.6	6.22	108.5	391.6	6.13
51.3	198.8	6.06	403.8	413.9	6.14	96.2	403.9	6.21
45.4	204.7	6.10	416.2	426.3	6.10	83.8	416.3	6.21
39.5	210.6	6.12	428.5	438.6	6.18	71.5	428.6	6.25
33.6	216.5	6.15	440.8	450.9	6.20	59.2	440.9	6.33
27.7	222.4	6.12	453.1	463.2	6.25	46.9	453.2	6.31
21.8	228.3	6.16	465.4	475.5	6.27	34.6	465.5	6.40
15.9	234.2	6.20	477.7	487.8	6.17	22.3	477.8	6.48
10.0	240.1	6.22	490.0	500.1	6.22	10.0	490.1	6.53

Frequency Mixer

LRMS-1H+

Typical Performance Data

LO (MHz)	LO-RF ISOLATION (dB)			LO-IF ISOLATION (dB)		
	@LO (dBm)			@LO (dBm)		
	+14	+17	+20	+14	+17	+20
2.0	81.98	79.29	82.48	71.18	69.19	68.76
5.0	71.15	71.51	71.45	68.75	62.98	59.64
10.0	65.40	65.84	66.21	67.50	61.30	57.95
49.8	60.38	60.94	61.46	67.09	66.93	57.90
89.5	54.87	55.52	55.80	58.82	65.15	55.51
129.2	51.17	51.37	52.09	54.48	61.28	52.19
168.9	48.46	48.80	49.64	50.53	58.09	51.23
208.6	46.08	46.99	47.65	47.86	52.67	49.54
248.3	44.39	45.18	45.58	45.86	50.05	48.42
287.9	43.16	44.13	44.31	42.06	45.32	46.27
327.6	41.83	42.64	43.05	39.69	43.01	44.91
367.3	41.00	40.93	41.07	37.59	40.74	42.83
446.7	40.39	40.19	39.98	34.26	37.09	39.84
486.4	39.55	40.22	40.40	33.40	35.40	37.41
526.1	38.11	38.81	39.17	32.67	35.56	36.89
565.8	37.18	37.62	37.67	30.77	34.35	36.79
585.6	36.25	36.75	36.92	30.08	34.02	37.61
625.3	34.93	35.65	35.91	28.64	32.27	37.06
645.2	33.86	34.69	35.27	28.10	31.21	36.07
684.9	32.61	33.32	34.14	27.61	30.35	34.33
744.4	31.71	32.17	33.08	27.12	29.73	32.92
764.3	31.46	31.78	32.48	27.06	29.50	32.76
803.9	31.85	32.25	33.04	27.41	28.88	31.57
823.8	31.77	32.14	32.94	27.60	28.75	30.92
863.5	32.45	33.20	34.15	28.27	28.57	29.38
883.3	32.82	33.93	35.22	28.64	28.79	28.99
923.0	33.45	35.06	36.48	29.17	29.72	29.28
942.9	33.83	35.23	36.04	29.51	30.60	30.07
982.6	34.10	35.28	35.90	29.27	32.29	32.56
1002.4	33.84	34.96	35.59	28.96	32.75	34.36
1042.1	34.09	34.53	34.61	27.44	31.16	35.37
1061.9	34.66	34.93	35.16	26.73	29.92	33.91
1101.6	35.11	34.90	34.90	25.35	27.67	30.90
1121.5	35.13	34.31	33.87	24.77	26.84	29.96
1181.0	34.12	33.58	33.75	23.61	25.21	27.75
1220.7	32.24	32.15	32.56	23.27	24.92	27.58
1240.6	31.47	31.59	32.36	23.04	24.65	27.25
1280.3	29.98	30.57	31.69	23.17	24.98	27.45
1300.1	29.07	29.85	30.91	23.32	25.26	27.84

RF (IN) (MHz)	LO (MHz)	RF-IF ISOLATION (dB)		
		@LO (dBm)		
		+14	+17	+20
10.1	40.1	43.46	49.31	40.13
49.8	79.8	32.39	32.52	32.43
89.5	119.5	27.87	28.12	28.16
129.2	159.2	25.26	25.49	25.63
168.9	198.9	23.47	23.73	23.96
208.6	238.6	22.24	22.70	22.98
248.3	278.3	21.63	21.79	21.95
287.9	317.9	21.41	21.88	22.05
327.6	357.6	20.93	21.57	22.10
367.3	397.3	20.74	21.43	22.06
407.0	437.0	21.29	21.82	22.36
446.7	476.7	22.13	22.43	22.55
486.4	516.4	22.76	23.21	23.44
526.1	556.1	21.98	22.59	23.44
565.8	595.8	20.00	20.59	21.57
585.6	615.6	18.89	19.28	20.01
625.3	655.3	17.16	17.19	17.43
645.2	675.2	16.43	16.32	16.37
684.9	714.9	15.29	14.95	14.73
704.7	734.7	14.83	14.52	14.22
744.4	774.4	14.08	13.61	13.30
764.3	794.3	13.65	13.15	12.84
823.8	853.8	12.76	12.36	12.05
863.5	893.5	12.32	12.01	11.74
883.3	913.3	12.07	11.82	11.60
923.0	953.0	11.72	11.52	11.39
942.9	972.9	11.57	11.41	11.27
982.6	1012.6	11.36	11.23	11.15
1002.4	1032.4	11.22	11.11	11.02
1042.1	1072.1	10.93	10.87	10.81
1061.9	1091.9	10.74	10.72	10.74
1101.6	1131.6	10.16	10.18	10.24
1121.5	1151.5	9.88	9.99	10.07
1161.2	1191.2	9.39	9.54	9.70
1181.0	1211.0	9.12	9.29	9.45
1220.7	1250.7	8.71	8.93	9.08
1240.6	1270.6	8.49	8.70	8.83
1280.3	1310.3	8.10	8.24	8.29
1300.1	1330.1	7.90	8.00	8.03



Frequency Mixer

LRMS-1H+

Typical Performance Data

RF (IN) (MHz)	LO (MHz)	RF VSWR (:1)			LO (MHz)	LO VSWR (:1)			IF (OUT) (MHz)	IF VSWR @LO=500.5MHz (:1)		
		@LO (dBm)				@LO (dBm)				@LO (dBm)		
		+14	+17	+20		+14	+17	+20		+14	+17	+20
2.0	32.0	1.22	1.77	2.58	2.0	1.31	1.33	1.37	2.0	1.02	1.07	1.13
5.0	35.0	1.15	1.75	2.56	5.0	1.17	1.20	1.25	5.0	1.01	1.06	1.12
10.0	40.0	1.22	1.82	2.67	10.0	1.11	1.15	1.20	10.0	1.02	1.04	1.10
49.8	79.8	1.25	1.11	1.02	49.8	1.03	1.65	2.46	22.3	1.98	1.74	1.50
89.5	119.5	1.25	1.10	1.02	89.5	1.04	1.55	2.24	34.5	1.88	1.64	1.41
129.2	159.2	1.21	1.08	1.03	129.2	1.01	1.61	2.39	46.8	1.86	1.63	1.42
168.9	198.9	1.21	1.08	1.05	168.9	1.05	1.58	2.30	59.0	1.85	1.62	1.40
208.6	238.6	1.18	1.07	1.08	208.6	1.07	1.59	2.31	71.3	1.83	1.58	1.38
248.3	278.3	1.22	1.10	1.08	248.3	1.08	1.63	2.37	83.5	1.88	1.63	1.42
287.9	317.9	1.18	1.09	1.11	287.9	1.14	1.61	2.31	95.8	1.92	1.67	1.46
327.6	357.6	1.18	1.10	1.13	327.6	1.15	1.66	2.40	108.0	1.98	1.73	1.50
367.3	397.3	1.17	1.10	1.14	367.3	1.22	1.68	2.36	120.3	1.91	1.68	1.45
407.0	437.0	1.16	1.10	1.15	407.0	1.23	1.69	2.39	132.5	1.91	1.68	1.45
446.7	476.7	1.18	1.12	1.15	446.7	1.27	1.74	2.43	144.8	1.87	1.64	1.42
486.4	516.4	1.18	1.16	1.20	486.4	1.32	1.74	2.41	157.0	1.88	1.64	1.42
526.1	556.1	1.20	1.21	1.25	526.1	1.34	1.79	2.47	169.3	1.89	1.65	1.43
565.8	595.8	1.22	1.25	1.31	565.8	1.41	1.81	2.46	181.5	1.94	1.70	1.48
585.6	615.6	1.24	1.27	1.34	585.6	1.42	1.82	2.47	193.8	2.00	1.75	1.52
625.3	655.3	1.24	1.29	1.37	625.3	1.49	1.88	2.53	206.0	1.97	1.73	1.51
645.2	675.2	1.24	1.29	1.37	645.2	1.51	1.89	2.52	218.3	1.98	1.73	1.51
684.9	714.9	1.21	1.26	1.33	684.9	1.56	1.93	2.54	230.5	1.94	1.69	1.48
704.7	734.7	1.21	1.24	1.30	704.7	1.58	1.96	2.59	242.8	1.92	1.68	1.46
744.4	774.4	1.19	1.18	1.24	744.4	1.62	2.01	2.61	255.0	1.91	1.68	1.47
764.3	794.3	1.21	1.18	1.22	764.3	1.63	2.02	2.62	267.3	1.93	1.70	1.49
803.9	833.9	1.25	1.19	1.22	803.9	1.65	2.05	2.67	279.5	1.99	1.75	1.53
823.8	853.8	1.29	1.23	1.24	823.8	1.66	2.07	2.68	291.8	2.01	1.76	1.54
863.5	893.5	1.39	1.33	1.32	863.5	1.68	2.06	2.67	316.3	2.04	1.79	1.56
883.3	913.3	1.46	1.40	1.39	883.3	1.69	2.07	2.68	328.5	1.98	1.74	1.52
923.0	953.0	1.64	1.58	1.56	923.0	1.72	2.09	2.70	340.8	1.97	1.74	1.52
942.9	972.9	1.75	1.68	1.65	942.9	1.73	2.09	2.68	353.0	1.98	1.74	1.53
982.6	1012.6	1.99	1.90	1.86	982.6	1.76	2.08	2.67	365.3	2.01	1.77	1.56
1002.4	1032.4	2.13	2.02	1.97	1002.4	1.78	2.09	2.67	377.5	2.03	1.78	1.57
1042.1	1072.1	2.40	2.26	2.19	1042.1	1.85	2.12	2.69	389.8	2.04	1.80	1.58
1061.9	1091.9	2.54	2.39	2.31	1061.9	1.88	2.12	2.69	402.0	2.09	1.84	1.62
1101.6	1131.6	2.78	2.61	2.50	1101.6	1.95	2.16	2.70	414.3	2.11	1.86	1.63
1121.5	1151.5	2.88	2.72	2.60	1121.5	1.99	2.17	2.71	426.5	2.10	1.84	1.62
1181.0	1211.0	3.08	2.95	2.83	1181.0	2.12	2.24	2.74	438.8	2.10	1.85	1.63
1220.7	1250.7	3.20	3.09	2.97	1220.7	2.23	2.29	2.77	451.0	2.05	1.81	1.60
1240.6	1270.6	3.21	3.11	2.99	1240.6	2.29	2.33	2.80	463.3	2.07	1.83	1.63
1280.3	1310.3	3.28	3.20	3.09	1280.3	2.42	2.40	2.84	487.8	2.18	1.94	1.72
1300.1	1330.1	3.28	3.19	3.09	1300.1	2.49	2.43	2.84	500.0	2.07	1.87	1.69

Harmonics Tables

RF HARMONICS ORDER

	(-dBm)	(-dBc)										
0	-	-	22	26	15	28	21	33	52	48	36	40
1	-	16	+0	26	14	31	22	37	36	46	34	48
2	88	71	49	64	48	62	48	63	50	63	65	66
3	>100	59	61	65	57	67	50	68	50	63	47	64
4	>100	79	73	79	72	79	77	85	83	88	79	79
5	>100	79	77	82	73	80	70	78	69	79	69	87
6	>100	89	92	>93	91	>93	87	90	88	>93	87	>93
7	>100	>93	>93	>93	92	>93	91	90	88	92	92	>93
8	>100	>93	>93	>93	>93	>93	>93	>93	>93	>93	>93	>93
9	>100	>93	>93	>93	>93	>93	>93	>93	>93	78	>93	>93
10	>100	>93	>93	>93	>93	>93	>93	>93	>93	>93	83	>93
	RF CAL	0	1	2	3	4	5	6	7	8	9	10

LO HARMONICS ORDER

Test conditions: RF IN: 250.1 MHz; -1.00 dBm.
 LO IN: 280.01 MHz; +17.00 dBm
 IF OUT: 29.91 MHz; -7.28 dBm

RF HARMONICS ORDER

	(-dBm)	(-dBc)										
0	-	-	33	37	27	42	36	53	54	63	68	66
1	-	16	+0	27	13	34	22	35	34	53	46	60
2	76	60	47	65	44	56	42	54	44	56	64	67
3	>100	44	44	47	49	50	46	47	58	60	42	56
4	>100	70	62	68	59	65	59	63	57	67	58	70
5	>100	61	63	73	59	66	52	59	48	59	48	61
6	>100	73	70	78	68	79	68	75	70	75	68	76
7	>100	74	72	76	67	71	69	71	62	68	60	68
8	>100	87	78	77	77	82	76	84	76	84	78	89
9	>100	88	80	77	77	79	72	81	69	75	68	73
10	>100	>103	101	87	87	84	90	84	85	90	91	102
	RF CAL	0	1	2	3	4	5	6	7	8	9	10

LO HARMONICS ORDER

Test conditions: RF IN: 250.1 MHz; 9.00 dBm.
 LO IN: 280.01 MHz; +17.00 dBm
 IF OUT: 29.91 MHz; 2.7 dBm

- Notes: 1. All Harmonics are in (dBc) relative to IF OUTPUT.
 2. + entry denotes harmonics are in (dBc) above IF OUTPUT.
 3. RF Cal represent the Harmonics level of the RF input signal to the mixer.

REV. X2
 LRMS-1H+
 100817
 Page 5 of 5



IF/RF MICROWAVE COMPONENTS • ISO 9001 ISO 14001 AS 9100 CERTIFIED • RoHS compliant
 P.O. Box 350166, Brooklyn, New York 11235-0006 (718) 934-4500 Fax (718) 332-4661



The Design Engineers Search Engine finds the model you need, Instantly • For detailed performance specs & shopping online see



Frequency Mixer

LRMS-1H+

Typical Performance Curves

Conversion Loss @ IF=30MHz

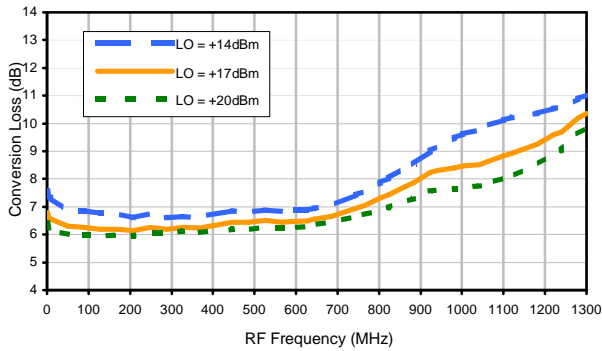

Conversion Loss vs. IF @ RF=250.1MHz

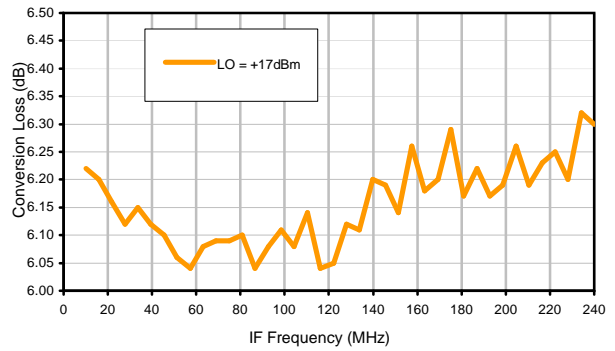

Conversion Loss vs. IF @ RF=10.1MHz

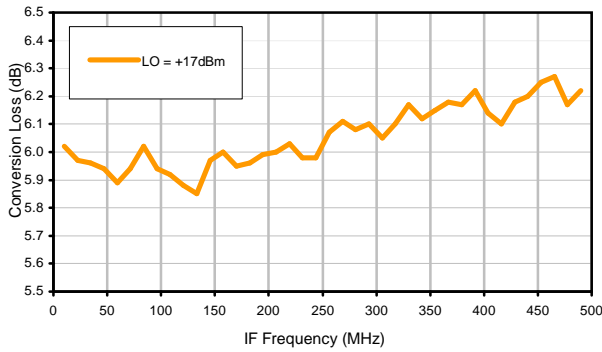

Conversion Loss vs. IF @ RF=500.1MHz

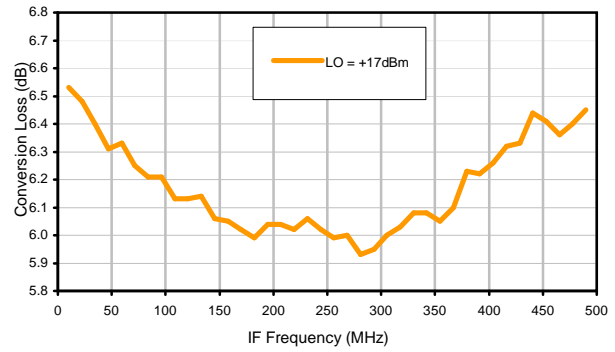

IP3 Input

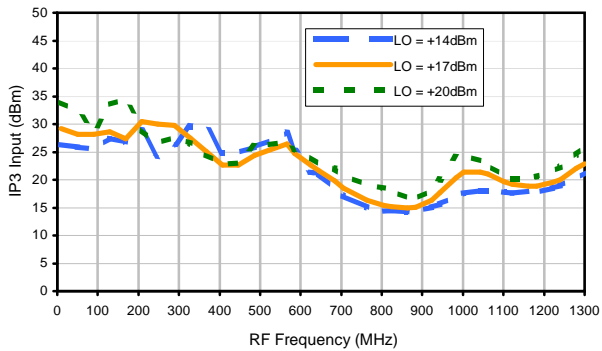

Compression @ RF IN=+14dBm

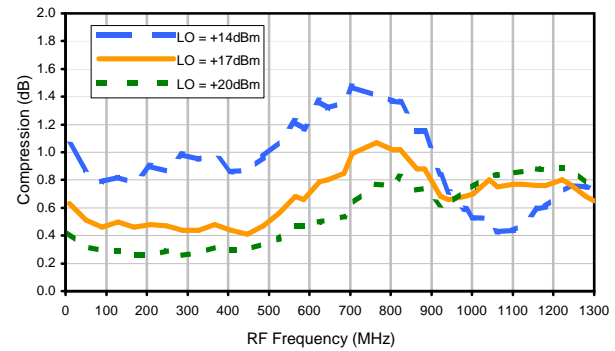

Typical Performance Curves

LO-RF Isolation

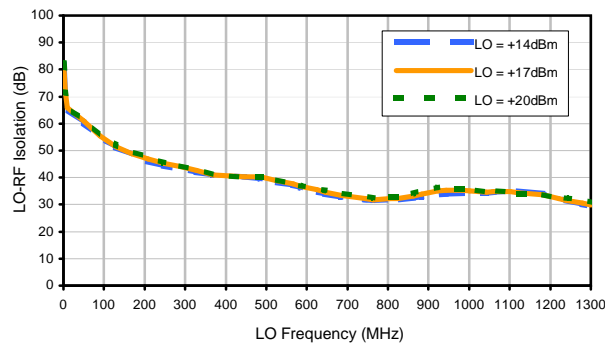

LO-IF Isolation

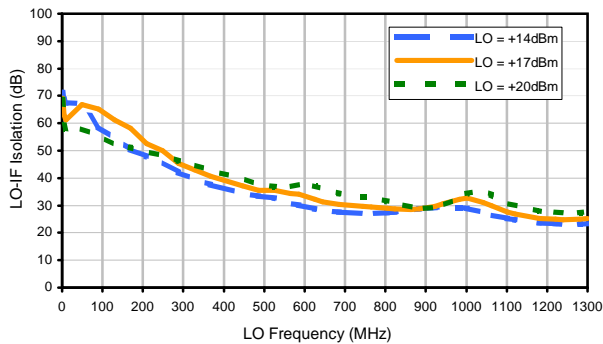

RF-IF Isolation

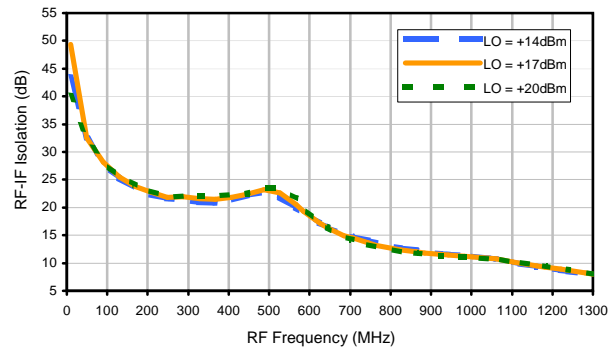

RF VSWR

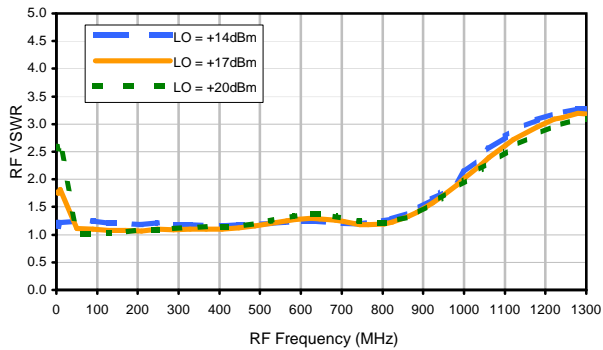

LO VSWR

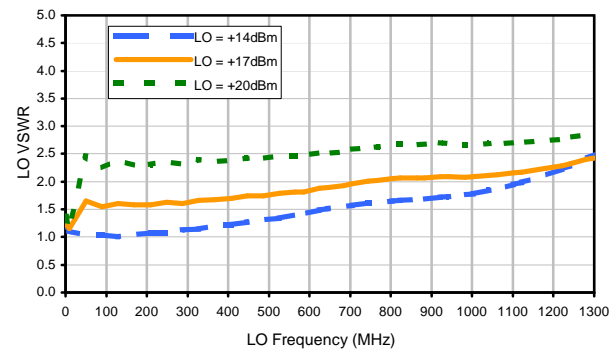

IF VSWR

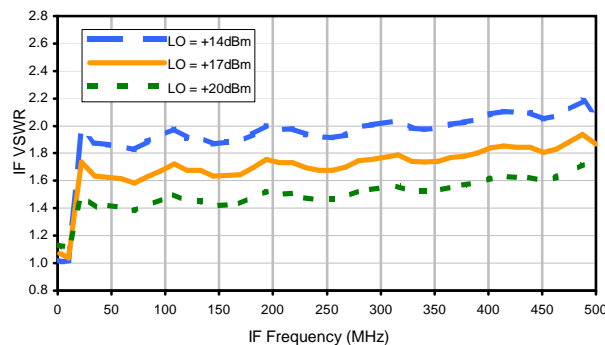

Harmonics Tables

RF HARMONICS ORDER

	(-dBm)	(-dBc)										
0	-	-	22	26	15	28	21	33	52	48	36	40
1	-	16	+0	26	14	31	22	37	36	46	34	48
2	88	71	49	64	48	62	48	63	50	63	65	66
3	>100	59	61	65	57	67	50	68	50	63	47	64
4	>100	79	73	79	72	79	77	85	83	88	79	79
5	>100	79	77	82	73	80	70	78	69	79	69	87
6	>100	89	92	>93	91	>93	87	90	88	>93	87	>93
7	>100	>93	>93	>93	92	>93	91	90	88	92	92	>93
8	>100	>93	>93	>93	>93	>93	>93	>93	>93	>93	>93	>93
9	>100	>93	>93	>93	>93	>93	>93	>93	>93	78	>93	>93
10	>100	>93	>93	>93	>93	>93	>93	>93	>93	>93	83	>93
	RF CAL	0	1	2	3	4	5	6	7	8	9	10

LO HARMONICS ORDER

Test conditions: RF IN: 250.1 MHz; -1.00 dBm.
 LO IN: 280.01 MHz; +17.00 dBm
 IF OUT: 29.91 MHz; -7.28 dBm

RF HARMONICS ORDER

	(-dBm)	(-dBc)										
0	-	-	33	37	27	42	36	53	54	63	68	66
1	-	16	+0	27	13	34	22	35	34	53	46	60
2	76	60	47	65	44	56	42	54	44	56	64	67
3	>100	44	44	47	49	50	46	47	58	60	42	56
4	>100	70	62	68	59	65	59	63	57	67	58	70
5	>100	61	63	73	59	66	52	59	48	59	48	61
6	>100	73	70	78	68	79	68	75	70	75	68	76
7	>100	74	72	76	67	71	69	71	62	68	60	68
8	>100	87	78	77	77	82	76	84	76	84	78	89
9	>100	88	80	77	77	79	72	81	69	75	68	73
10	>100	>103	101	87	87	84	90	84	85	90	91	102
	RF CAL	0	1	2	3	4	5	6	7	8	9	10

LO HARMONICS ORDER

Test conditions: RF IN: 250.1 MHz; 9.00 dBm.
 LO IN: 280.01 MHz; +17.00 dBm
 IF OUT: 29.91 MHz; 2.7 dBm

- Notes: 1. All Harmonics are in (dBc) relative to IF OUTPUT.
 2. + entry denotes harmonics are in (dBc) above IF OUTPUT.
 3. RF Cal represent the Harmonics level of the RF input signal to the mixer.

REV. X2
 LRMS-1H+
 100817
 Page 3 of 3



IF/RF MICROWAVE COMPONENTS • ISO 9001 ISO 14001 AS 9100 CERTIFIED • RoHS compliant
 P.O. Box 350166, Brooklyn, New York 11235-0006 (718) 934-4500 Fax (718) 332-4661



The Design Engineers Search Engine finds the model you need, Instantly • For detailed performance specs & shopping online see minicircuits.com

Case Style

QQQ

QQQ130 (non-waterproof)
QQQ828 (washable)

Outline Dimensions

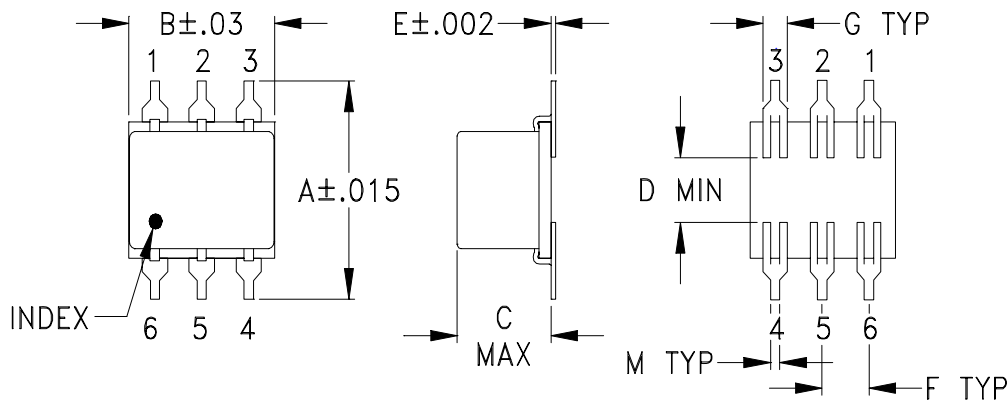

PCB Land Pattern

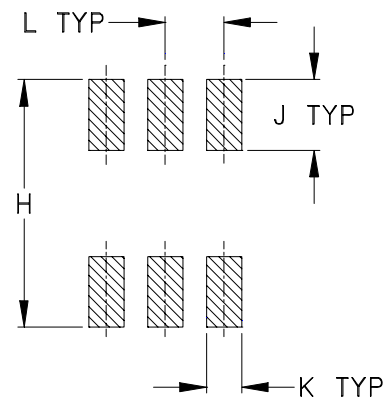

Suggested Layout,
Tolerance to be within $\pm .002$

CASE#	A	B	C	D	E	F	G	H	J	K	L	M	WT, GRAM
QQQ130	.400 (10.16)	.31 (7.87)	.200 (5.08)	.10 (2.54)	.010 (.25)	.100 (2.54)	.050 (1.27)	.420 (10.67)	.120 (3.05)	.060 (1.52)	.100 (2.54)	.020 (.51)	.55
QQQ828			.050 (1.27)										.20

Dimensions are in inches (mm). Tolerances: 2 Pl. $\pm .01$; 3 Pl. $\pm .005$

Notes:

- Case material: Ceramic.
- Termination finish:
 - For RoHS Case Styles: Tin plate over Nickel plate.
 - For RoHS-5 Case Styles: Tin-Lead plate.



INTERNET <http://www.minicircuits.com>

P.O. Box 350166, Brooklyn, New York 11235-0003 (718) 934-4500 Fax (718) 332-4661

Distribution Centers NORTH AMERICA 800-654-7949 • 417-335-5935 • Fax 417-335-5945 • EUROPE 44-1252-832600 • Fax 44-1252-837010

Mini-Circuits ISO 9001 & ISO 14001 Certified

Tape & Reel Packaging TR-F10

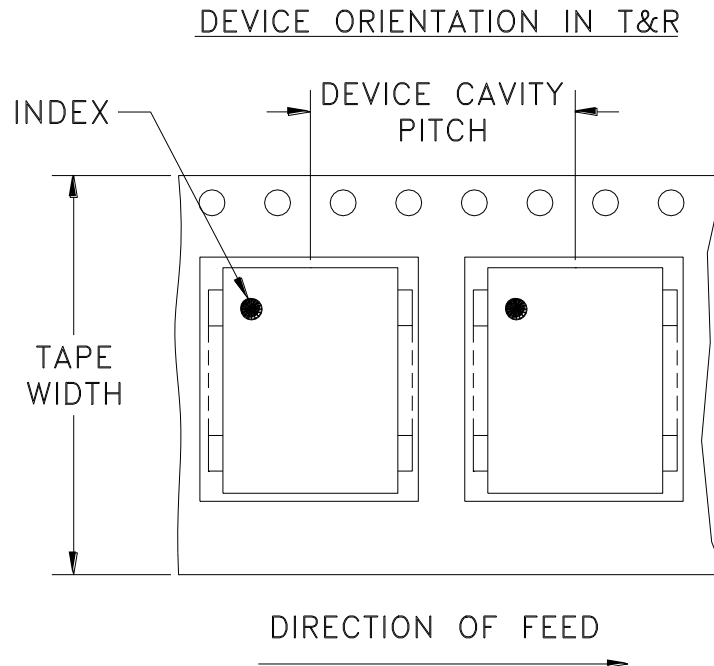

Tape Width, mm	Device Cavity Pitch, mm	Reel Size, inches	Devices per Reel
24	16	7	10,20,50,100,200
		13	500

Mini-Circuits carrier tape materials provide protection from ESD (Electro-Static Discharge) during handling and transportation. Tapes are static dissipative and comply with industry standards EIA-481/EIA-541.

Go to: www.minicircuits.com/pages/pdfs/tape.pdf

Note: Please consult individual model data sheet to determine device per reel availability.



INTERNET <http://www.minicircuits.com>

P.O. Box 350166, Brooklyn, New York 11235-0003 (718) 934-4500 Fax (718) 332-4661

Distribution Centers NORTH AMERICA 800-654-7949 • 417-335-5935 • Fax 417-335-5945 • EUROPE 44-1252-832600 • Fax 44-1252-837010

Mini-Circuits ISO 9001 & ISO 14001 Certified

THIRD ANGLE PROJECTION

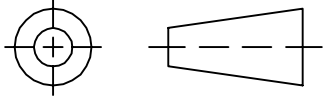

REVISIONS

REV	ECN No.	DESCRIPTION	DATE	DR	AUTH
OR	M82272	NEW RELEASE	08/02/02	AV	DJ
A	M102713	UPDATED NOTES	01/14/06	GF	IL

SUGGESTED MOUNTING CONFIGURATION FOR QQQ569 CASE STYLE, "w" PIN CONNECTION

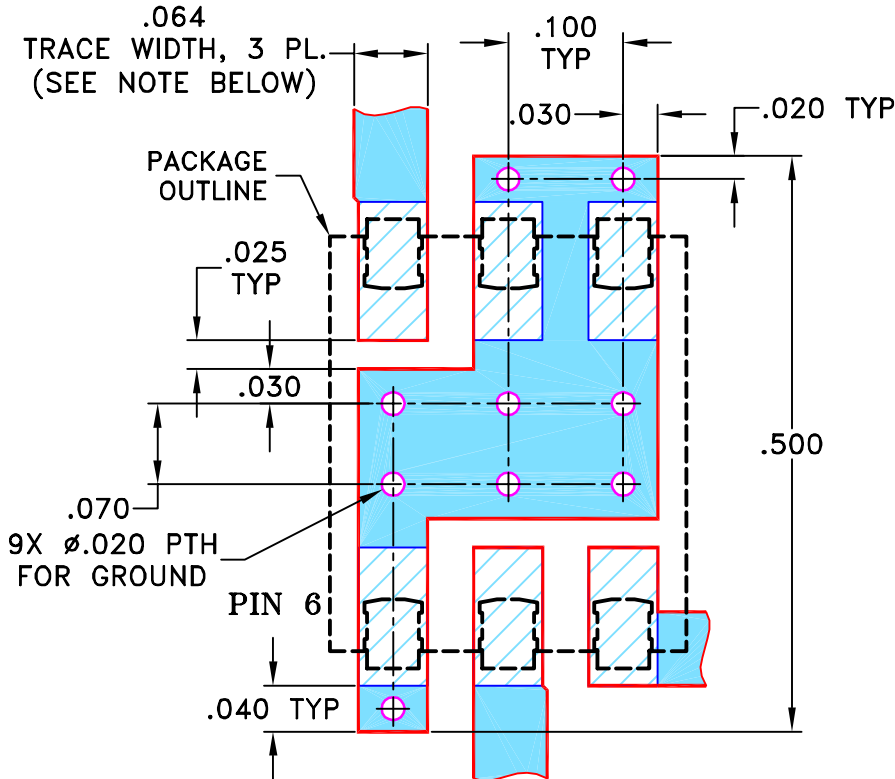

NOTES: 1. TRACE WIDTH IS SHOWN FOR ROGERS RO4350B WITH DIELECTRIC THICKNESS 0.030" ± 0.002"; COPPER: 1/2 OZ. EACH SIDE. FOR OTHER MATERIALS TRACE WIDTH MAY NEED TO BE MODIFIED.

2. BOTTOM SIDE OF THE PCB IS CONTINUOUS GROUND PLANE.



DENOTES PCB COPPER LAYOUT WITH SMOBC (SOLDER MASK OVER BARE COPPER)



DENOTES COPPER LAND PATTERN FREE OF SOLDER MASK

UNLESS OTHERWISE SPECIFIED

INITIALS

DATE

DIMENSIONS ARE IN INCHES

DRAWN

AV

07/19/02

TOLERANCES ON:

CHECKED

WL

08/02/02

2 PL DECIMALS ± .005

APPROVED

DJ

08/02/02

3 PL DECIMALS ±

ANGLES ±

FRACTIONS ±

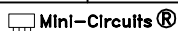

THIS DOCUMENT AND ITS CONTENTS ARE THE PROPERTY OF MINI-CIRCUITS. EXCEPT FOR USE EXPRESSLY GRANTED, IN WRITING, TO ITS VENDORS, VEEDEE AND THE UNITED STATES GOVERNMENT, MINI-CIRCUITS RESERVES ALL PROPRIETARY DESIGN, USE, MANUFACTURING AND REPRODUCTION RIGHTS THERETO. THESE CONTENTS SHALL NOT BE USED, DUPLICATED OR DISCLOSED TO ANY OUTSIDE PARTY, IN WHOLE OR IN PART, WITHOUT WRITTEN PERMISSION OF MINI-CIRCUITS.



Mini-Circuits®

13 Neptune Avenue
Brooklyn NY 11235

PL, w, QQQ569, LRMS-J, TB-44

SIZE

CODE IDENT

DRAWING NO:

REV:

A

15542

98-PL-083

A

FILE: 98PL083

SCALE:

6:1

SHEET:

1 OF 1

ASHEETA1.DWG REV:A DATE:01/12/95

Evaluation Board and Circuit

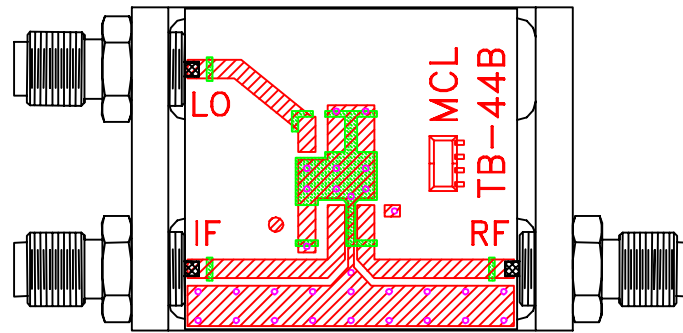

TB-44+

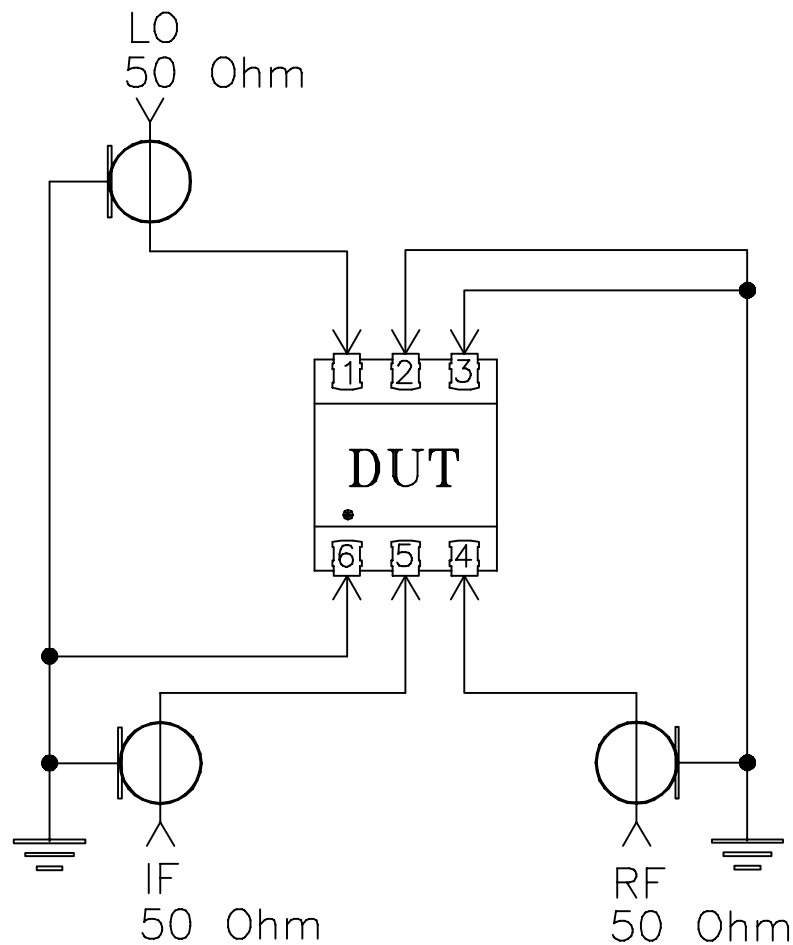

Schematic Diagram

Notes:

1. SMA Female connectors.
2. PCB Material: Rogers R04350 or equivalent,
Dielectric Constant=3.5, Thickness=.030 inch.

 Mini-Circuits®

All Mini-Circuits products are manufactured under exacting quality assurance and control standards, and are capable of meeting published specifications after being subjected to any or all of the following physical and environmental test.

Specification	Test/Inspection Condition	Reference/Spec
Operating Temperature	-40° to 85°C Ambient Environment	Individual Model Data Sheet
Storage Temperature	-55° to 100° C Ambient Environment	Individual Model Data Sheet
Humidity	90 to 95% RH, 240 hours, 50°C	MIL-STD-202, Method 103, Condition A, Except 50°C and end-point electrical test done within 12 hours
Thermal Shock	-55° to 100°C, 100 cycles	MIL-STD-202, Method 107, Condition A-3, except +100°C
Solder Reflow Heat	Sn-Pb Eutetic Process: 225°C peak Pb-Free Process 245° - 250°C peak	J-STD-020, Table 4-1, 4-2 and 5-2, Figure 5-1
Solderability	10X Magnification	J-STD-002, 95% Coverage
Vibration (High Frequency)	20g peak, 10-2000 Hz, 12 times in each of three perpendicular directions (total 36)	MIL-STD-202, Method 204, Condition D
Mechanical Shock	50g, 11 ms, 1/2-sine, 18 shocks: 3 each direction, each of 3 axes	MIL-STD-202, Method 213, Condition A
Marking Resistance to Solvents	Isopropyl alcohol + mineral spirits at 25°C; terpene defluxer at 25°C; distilled water + proylene glycol monomethyl ether + monoethanolamine at 63°C to 70°C	MIL-STD-202, Method 215