

Surface Mount Frequency Mixer

SYM-25DMHW+ SYM-25DMHW

Level 13 (LO Power +13 dBm) 40 to 2500 MHz



Generic photo used for illustration purposes only

CASE STYLE: TTT167

+RoHS Compliant

The +Suffix identifies RoHS Compliance. See our web site for RoHS Compliance methodologies and qualifications

Available Tape and Reel at no extra cost

Reel Size	Devices/Reel
7"	10, 20, 50, 100, 200
13"	500

Maximum Ratings

Operating Temperature	-40°C to 85°C
Storage Temperature	-55°C to 100°C
RF Power	200mW
IF Current	40mA

Permanent damage may occur if any of these limits are exceeded.

Pin Connections

LO	2
RF	1
IF	3
GROUND	4,5,6

Outline Drawing

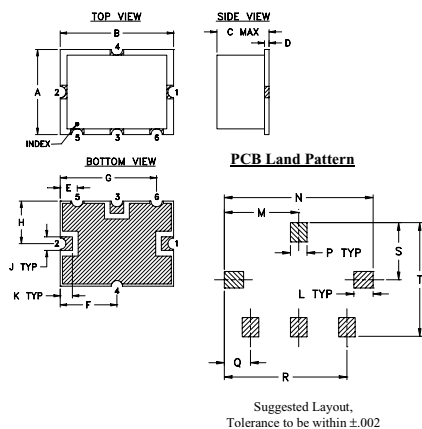

Outline Dimensions (inch/mm)

A	B	C	D	E	F	G	H	J	K
.38	.50	.23	.020	.075	.250	.425	.187	.050	.050
9.65	12.70	5.84	0.51	1.91	6.35	10.80	4.75	1.27	1.27
L	M	N	P	Q	R	S	T	wt.	
.070	.270	.540	.060	.095	.445	.208	.415	grams	
1.78	6.86	13.72	1.52	2.41	11.30	5.28	10.54	0.8	

Demo Board MCL P/N: TB-12 Suggested PCB Layout (PL-079)

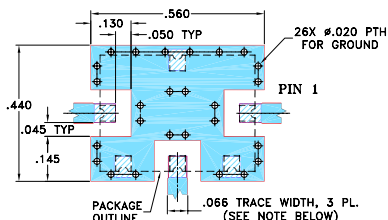

NOTE:

- TRACE WIDTH IS SHOWN FOR ROGERS RO4350B WITH DIELECTRIC THICKNESS .030" ± .002"; COPPER: 1/2 OZ. EACH SIDE. FOR OTHER MATERIALS TRACE WIDTH MAY NEED TO BE MODIFIED.
- THE USE OF SOLDER MASK OVER THE GROUND AREA UNDER THE UNIT AS SHOWN IS RECOMMENDED TO PREVENT POTENTIAL SHORTING. IF USER CHOOSES TO EXPOSE METAL UNDER THE ENTIRE UNIT GROUND PAD FOR IMPROVED GROUNDING, IT IS RECOMMENDED A SOLDER MASK DAM BE APPLIED AROUND EACH GROUND PAD TO ENSURE FILLET AND CONNECTION AT GROUND PADS.
- BOTTOM SIDE OF THE PCB IS CONTINUOUS GROUND PLANE.

Notes

- Performance and quality attributes and conditions not expressly stated in this specification document are intended to be excluded and do not form a part of this specification document.
- Electrical specifications and performance data contained in this specification document are based on Mini-Circuit's applicable established test performance criteria and measurement instructions.
- The parts covered by this specification document are subject to Mini-Circuit's standard limited warranty and terms and conditions (collectively, "Standard Terms"); Purchasers of this part are entitled to the rights and benefits contained therein. For a full statement of the Standard Terms and the exclusive rights and remedies thereunder, please visit Mini-Circuit's website at www.minicircuits.com/MCLStore/terms.jsp

Features

- wideband, 40 to 2500 MHz
- low conversion loss, 6.6 dB typ.
- high IP3, 26 dBm typ.
- IF response to DC

Applications

- cellular
- PCS
- satellite distribution

Electrical Specifications

FREQUENCY (MHz)	CONVERSION LOSS* (dB)	LO-RF ISOLATION (dB)			LO-IF ISOLATION (dB)			IP3 at center band (dBm)										
		L	M	U	L	M	U											
40-2500	DC-1000*	6.6	.10	8.0	9.0	47	32	37	27	35	22	38	28	35	25	38	20	26

1 dB COMP: +9 dBm typ.

*Conversion loss increases up to 6 dB higher as IF frequency decreases from 5MHz to DC.

L = low range [f_1 to $10 f_1$]

m = mid band [$2 f_1$ to $f_1/2$]

M = mid range [$10 f_1$ to $f_1/2$]

U = upper range [$f_1/2$ to f_1]

Typical Performance Data

Frequency (MHz)		Conversion Loss (dB)	Isolation L-R (dB)	Isolation L-I (dB)	VSWR RF Port (:1)	VSWR LO Port (:1)
RF	LO	LO +13dBm	LO +13dBm	LO +13dBm	LO +13dBm	LO +13dBm
10.10	80.10	6.05	53.30	37.85	1.14	1.50
100.10	170.10	6.13	61.96	37.66	1.14	1.48
200.10	270.10	6.20	57.62	37.58	1.17	1.45
400.10	470.10	6.17	51.91	37.25	1.28	1.42
644.24	714.24	6.32	48.85	36.97	1.49	1.26
805.62	875.62	6.34	44.29	34.60	1.70	1.20
1000.10	1070.10	6.49	40.91	34.12	2.01	1.11
1209.07	1279.07	6.72	36.71	32.67	2.27	1.04
1451.13	1521.13	6.87	35.32	33.07	2.79	1.08
1500.10	1570.10	6.99	35.51	33.59	2.90	1.11
1612.51	1682.51	6.98	36.55	34.68	2.94	1.18
1854.58	1924.58	7.66	35.12	37.81	2.52	1.35
2000.10	2070.10	8.04	33.74	39.74	2.41	1.47
2177.34	2247.34	8.02	32.04	37.96	2.21	1.59
2258.03	2328.03	8.00	31.23	35.83	2.14	1.65
2419.41	2489.41	7.92	30.39	32.11	2.09	1.85
2500.10	2430.10	7.67	29.98	30.34	1.82	2.00

Electrical Schematic

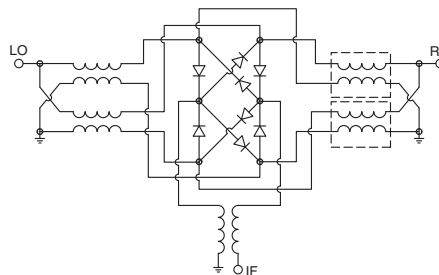

Performance Charts

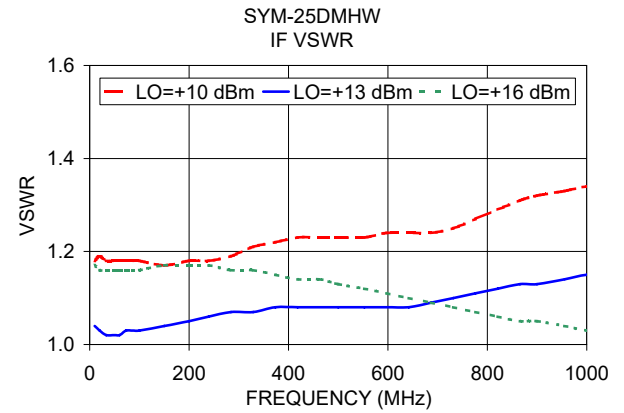
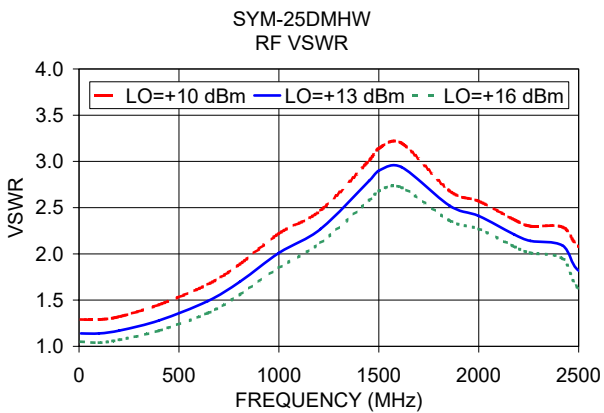
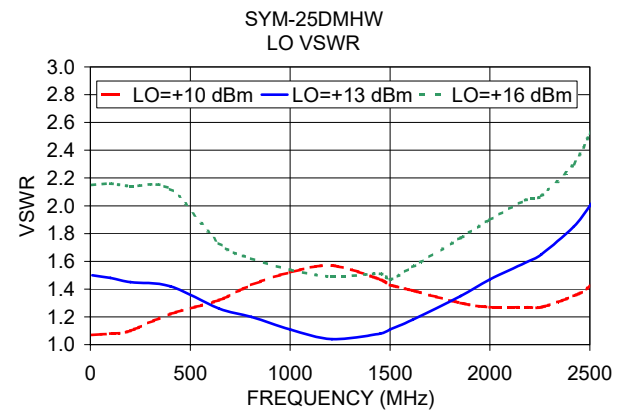
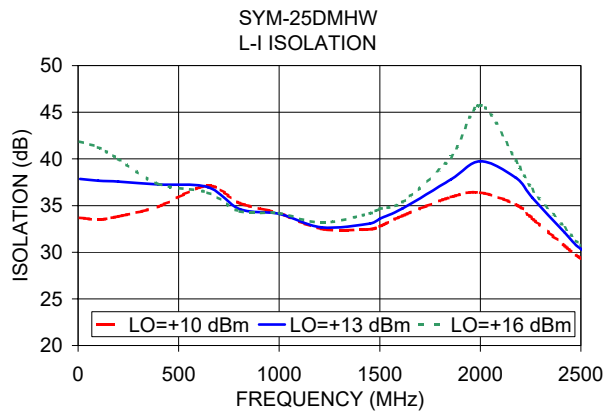
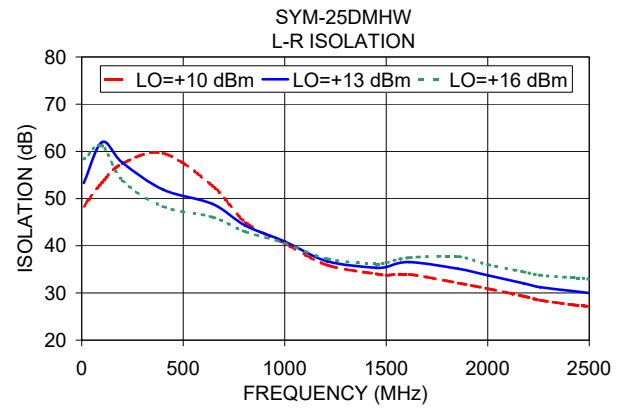
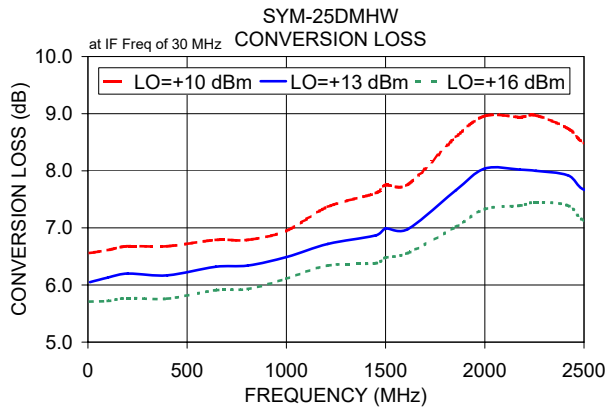

Notes

- Performance and quality attributes and conditions not expressly stated in this specification document are intended to be excluded and do not form a part of this specification document.
- Electrical specifications and performance data contained in this specification document are based on Mini-Circuits' applicable established test performance criteria and measurement instructions.
- The parts covered by this specification document are subject to Mini-Circuits' standard limited warranty and terms and conditions (collectively, "Standard Terms"); Purchasers of this part are entitled to the rights and benefits contained therein. For a full statement of the Standard Terms and the exclusive rights and remedies thereunder, please visit Mini-Circuits' website at www.minicircuits.com/MCLStore/terms.jsp

Frequency Mixer

SYM-25DMHW+

Typical Performance Data

RF (IN) (MHz)	LO (MHz)	CONVERSION LOSS IF FIXED @IF(OUT)=30MHz (dB)			RF (IN) (MHz)	LO (MHz)	IP3 INPUT (dBm)			RF (IN) (MHz)	LO (MHz)	COMPRESSION @RF IN=+9dBm (dB)		
		@LO (dBm)					@LO (dBm)					@LO (dBm)		
		+10	+13	+16			+10	+13	+16			+10	+13	+16
10.1	40.1	6.50	5.97	5.74	10.1	40.1	31.69	34.12	29.65	10.1	40.1	0.60	0.27	0.12
90.3	120.3	6.82	6.27	5.95	90.3	120.3	24.21	25.72	26.04	90.3	120.3	0.57	0.26	0.12
170.6	200.6	6.81	6.32	6.00	170.6	200.6	22.96	25.04	26.75	170.6	200.6	0.55	0.23	0.12
250.8	280.8	6.87	6.36	6.02	250.8	280.8	22.60	24.37	23.37	250.8	280.8	0.58	0.25	0.13
331.0	361.0	6.90	6.31	6.00	331.0	361.0	22.87	23.33	21.60	331.0	361.0	0.58	0.26	0.13
411.3	441.3	6.96	6.33	6.00	411.3	441.3	22.25	21.58	21.56	411.3	441.3	0.54	0.26	0.14
491.5	521.5	6.95	6.32	6.00	491.5	521.5	22.14	20.55	22.47	491.5	521.5	0.53	0.27	0.13
571.8	601.8	6.93	6.30	6.03	571.8	601.8	19.75	20.58	24.02	571.8	601.8	0.58	0.25	0.11
652.0	682.0	6.92	6.33	6.06	652.0	682.0	19.41	21.26	26.15	652.0	682.0	0.60	0.24	0.10
732.2	762.2	6.91	6.37	6.10	732.2	762.2	19.21	21.47	27.49	732.2	762.2	0.58	0.22	0.11
812.5	842.5	6.91	6.38	6.11	812.5	842.5	19.22	21.95	27.68	812.5	842.5	0.58	0.20	0.11
892.7	922.7	6.95	6.43	6.16	892.7	922.7	19.00	22.75	27.59	892.7	922.7	0.57	0.22	0.11
972.9	1002.9	7.02	6.45	6.17	972.9	1002.9	18.89	23.56	32.34	972.9	1002.9	0.57	0.20	0.13
1053.2	1083.2	7.12	6.51	6.23	1053.2	1083.2	20.19	26.99	27.47	1053.2	1083.2	0.49	0.16	0.10
1133.4	1163.4	7.21	6.59	6.26	1133.4	1163.4	20.40	27.08	26.68	1133.4	1163.4	0.46	0.17	0.11
1233.7	1263.7	7.32	6.64	6.32	1233.7	1263.7	21.29	29.57	28.16	1233.7	1263.7	0.47	0.19	0.12
1313.9	1343.9	7.39	6.70	6.37	1313.9	1343.9	20.27	28.97	27.78	1313.9	1343.9	0.50	0.20	0.12
1414.2	1444.2	7.53	6.82	6.46	1414.2	1444.2	20.04	27.18	29.38	1414.2	1444.2	0.51	0.21	0.12
1494.5	1524.5	7.67	6.96	6.58	1494.5	1524.5	19.41	23.55	30.66	1494.5	1524.5	0.60	0.22	0.13
1594.8	1624.8	7.89	7.18	6.79	1594.8	1624.8	19.09	23.71	29.44	1594.8	1624.8	0.64	0.26	0.14
1675.0	1705.0	8.10	7.37	6.97	1675.0	1705.0	17.76	22.05	28.03	1675.0	1705.0	0.64	0.31	0.16
1775.3	1805.3	8.41	7.60	7.14	1775.3	1805.3	16.81	21.99	28.82	1775.3	1805.3	0.57	0.32	0.21
1855.5	1885.5	8.68	7.82	7.28	1855.5	1885.5	15.96	19.93	27.94	1855.5	1885.5	0.52	0.29	0.21
1955.8	1985.8	8.95	8.02	7.38	1955.8	1985.8	15.87	20.11	25.50	1955.8	1985.8	0.44	0.29	0.21
2036.1	2066.1	9.08	8.10	7.43	2036.1	2066.1	16.15	21.16	23.53	2036.1	2066.1	0.46	0.30	0.26
2136.4	2166.4	9.08	8.10	7.45	2136.4	2166.4	17.40	20.87	20.36	2136.4	2166.4	0.45	0.35	0.32
2216.6	2246.6	9.11	8.13	7.48	2216.6	2246.6	17.79	20.32	19.71	2216.6	2246.6	0.48	0.37	0.33
2316.9	2346.9	8.97	8.13	7.51	2316.9	2346.9	17.84	18.68	18.43	2316.9	2346.9	0.56	0.40	0.36
2397.1	2427.1	8.83	8.02	7.47	2397.1	2427.1	17.61	17.65	17.77	2397.1	2427.1	0.66	0.46	0.39
2497.4	2527.4	8.77	7.95	7.43	2497.4	2527.4	17.03	17.31	17.70	2497.4	2527.4	0.81	0.58	0.48
2577.7	2607.7	8.77	7.97	7.46	2577.7	2607.7	16.88	17.07	17.51	2577.7	2607.7	0.83	0.58	0.49
2678.0	2708.0	8.80	8.06	7.57	2678.0	2708.0	16.28	16.70	17.15	2678.0	2708.0	0.87	0.59	0.47
2758.2	2788.2	8.87	8.18	7.68	2758.2	2788.2	16.23	16.64	17.18	2758.2	2788.2	0.96	0.58	0.43
2858.5	2888.5	9.09	8.35	7.85	2858.5	2888.5	16.10	16.61	17.49	2858.5	2888.5	1.00	0.60	0.43
2938.7	2968.7	9.34	8.57	8.05	2938.7	2968.7	16.02	16.56	17.56	2938.7	2968.7	1.05	0.55	0.41
3039.0	3069.0	9.74	8.87	8.29	3039.0	3069.0	15.97	16.48	17.59	3039.0	3069.0	1.14	0.57	0.39
3119.3	3149.3	10.07	9.14	8.52	3119.3	3149.3	16.23	16.67	17.46	3119.3	3149.3	1.19	0.57	0.38
3219.6	3249.6	10.69	9.56	8.85	3219.6	3249.6	16.56	16.97	17.81	3219.6	3249.6	1.20	0.59	0.36
3299.8	3329.8	11.21	9.89	9.12	3299.8	3329.8	17.07	17.60	18.32	3299.8	3329.8	1.17	0.60	0.33
3400.1	3430.1	12.00	10.41	9.54	3400.1	3430.1	17.53	18.02	18.52	3400.1	3430.1	1.03	0.62	0.34



Frequency Mixer

SYM-25DMHW+

Typical Performance Data

IF (OUT) (MHz)	LO (MHz)	CONVERSION LOSS VS. IF FREQUENCY @RF(IN)=1250.1MHz (dB)	IF (OUT) (MHz)	LO (MHz)	CONVERSION LOSS VS. IF FREQUENCY @RF(IN)=40.1MHz (dB)	IF (OUT) (MHz)	LO (MHz)	CONVERSION LOSS VS. IF FREQUENCY @RF(IN)=2500.1MHz (dB)
		@LO (dBm)			@LO (dBm)			@LO (dBm)
		+13			+13			+13
1000.0	250.1	6.90	10.0	50.1	6.09	1000.0	1500.1	8.30
979.8	270.3	6.96	30.2	70.3	6.18	979.8	1520.3	8.26
959.6	290.5	7.00	50.4	90.5	6.23	959.6	1540.5	8.25
939.4	310.7	7.02	70.6	110.7	6.20	939.4	1560.7	8.23
919.2	330.9	6.96	90.8	130.9	6.15	919.2	1580.9	8.23
899.0	351.1	6.95	111.0	151.1	6.20	899.0	1601.1	8.18
878.8	371.3	6.97	131.2	171.3	6.22	878.8	1621.3	8.15
858.6	391.5	6.93	151.4	191.5	6.20	858.6	1641.5	8.15
838.4	411.7	6.97	171.6	211.7	6.22	838.4	1661.7	8.08
818.2	431.9	6.92	191.8	231.9	6.17	818.2	1681.9	8.07
798.0	452.1	6.88	212.0	252.1	6.16	798.0	1702.1	8.04
777.8	472.3	6.95	232.2	272.3	6.22	777.8	1722.3	8.01
757.6	492.5	6.89	252.4	292.5	6.19	757.6	1742.5	8.02
737.3	512.8	6.86	272.7	312.8	6.18	737.3	1762.8	7.98
717.1	533.0	6.86	292.9	333.0	6.12	717.1	1783.0	7.96
696.9	553.2	6.82	313.1	353.2	6.14	696.9	1803.2	7.92
676.7	573.4	6.83	333.3	373.4	6.15	676.7	1823.4	7.94
656.5	593.6	6.83	353.5	393.6	6.10	656.5	1843.6	7.94
636.3	613.8	6.82	373.7	413.8	6.11	636.3	1863.8	7.92
616.1	634.0	6.81	393.9	434.0	6.03	616.1	1884.0	7.94
575.7	674.4	6.81	434.3	474.4	6.07	575.7	1924.4	7.93
555.5	694.6	6.79	454.5	494.6	6.02	555.5	1944.6	7.92
515.1	735.0	6.78	494.9	535.0	5.98	515.1	1985.0	7.90
494.9	755.2	6.77	515.1	555.2	5.99	494.9	2005.2	7.83
454.5	795.6	6.78	555.5	595.6	5.98	454.5	2045.6	7.87
434.3	815.8	6.78	575.7	615.8	5.95	434.3	2065.8	7.86
393.9	856.2	6.78	616.1	656.2	5.96	393.9	2106.2	7.78
373.7	876.4	6.79	636.3	676.4	5.94	373.7	2126.4	7.79
333.3	916.8	6.75	676.7	716.8	5.93	333.3	2166.8	7.80
313.1	937.0	6.76	696.9	737.0	5.92	313.1	2187.0	7.81
272.7	977.4	6.74	737.3	777.4	5.97	272.7	2227.4	7.84
252.4	997.7	6.71	757.6	797.7	5.97	252.4	2247.7	7.87
212.0	1038.1	6.66	798.0	838.1	5.97	212.0	2288.1	7.88
191.8	1058.3	6.69	818.2	858.3	5.98	191.8	2308.3	7.85
151.4	1098.7	6.65	858.6	898.7	5.98	151.4	2348.7	7.92
131.2	1118.9	6.67	878.8	918.9	5.99	131.2	2368.9	7.90
90.8	1159.3	6.68	919.2	959.3	6.02	90.8	2409.3	7.87
70.6	1179.5	6.65	939.4	979.5	6.01	70.6	2429.5	7.92
30.2	1219.9	6.61	979.8	1019.9	6.02	30.2	2469.9	7.91
10.0	1240.1	6.57	1000.0	1040.1	6.03	10.0	2490.1	7.83

REV. X2
SYM-25DMHW+
100818
Page 2 of 5



IF/RF MICROWAVE COMPONENTS • ISO 9001 ISO 14001 AS 9100 CERTIFIED • RoHS compliant
P.O. Box 350166, Brooklyn, New York 11235-0006 (718) 934-4500 Fax (718) 332-4661



The Design Engineers Search Engine finds the model you need, Instantly • For detailed performance specs & shopping online see



Frequency Mixer

SYM-25DMHW+

Typical Performance Data

LO (MHz)	LO-RF ISOLATION (dB)			LO-IF ISOLATION (dB)		
	@LO (dBm)			@LO (dBm)		
	+10	+13	+16	+10	+13	+16
10.1	44.95	48.93	52.71	34.91	38.58	42.39
90.3	50.87	57.71	62.14	33.75	37.60	41.44
170.6	51.69	60.75	57.09	34.15	38.15	41.68
250.8	52.87	59.68	52.69	34.64	38.64	41.77
331.0	52.90	57.86	50.79	35.24	39.27	41.61
411.3	54.25	56.21	49.75	36.24	40.04	41.63
491.5	55.95	55.59	49.06	37.45	40.61	41.22
571.8	54.11	58.73	49.62	38.74	40.84	40.69
652.0	52.34	60.08	48.93	40.07	40.75	40.02
732.2	50.75	56.66	47.73	40.38	39.68	38.74
812.5	47.63	53.48	46.99	40.19	38.93	38.38
892.7	46.28	52.41	46.71	39.90	38.60	38.13
972.9	44.77	51.76	46.88	39.10	37.87	37.48
1053.2	42.95	49.74	46.89	38.89	37.44	37.15
1133.4	41.80	47.73	45.79	38.50	36.98	36.90
1233.7	40.86	46.06	44.15	38.59	37.47	37.41
1313.9	40.70	45.51	43.55	39.25	38.68	38.91
1414.2	41.48	46.64	42.48	40.19	40.20	40.98
1494.5	42.25	48.45	42.34	40.81	41.61	43.41
1594.8	44.21	53.10	42.31	40.17	41.42	44.70
1675.0	45.39	54.56	42.47	38.91	40.09	43.21
1775.3	45.60	51.27	43.33	36.95	37.47	39.51
1855.5	44.64	48.98	44.31	35.25	35.33	36.49
1955.8	43.40	48.12	46.71	33.18	32.92	33.47
2036.1	42.73	48.43	49.71	31.86	31.48	31.75
2136.4	42.52	51.51	54.26	30.09	29.57	29.72
2216.6	42.54	53.56	51.45	29.06	28.54	28.52
2316.9	42.12	50.51	48.42	27.70	27.19	27.09
2397.1	41.67	47.37	45.48	26.57	26.06	26.11
2497.4	40.46	43.36	42.38	25.56	25.14	25.11
2577.7	39.00	40.47	39.29	24.70	24.20	23.84
2678.0	37.10	38.15	36.99	23.93	23.66	23.22
2758.2	35.75	36.64	35.78	23.40	23.17	22.70
2858.5	34.10	34.84	34.45	22.68	22.62	22.23
2938.7	33.03	33.66	33.41	22.20	22.19	21.72
3039.0	31.95	32.44	32.17	21.97	22.00	21.57
3119.3	31.04	31.66	31.46	21.70	21.93	21.59
3219.6	29.72	30.83	31.03	21.53	22.09	21.84
3299.8	28.88	30.06	30.51	21.51	22.07	21.87
3400.1	28.15	29.38	30.18	21.63	22.32	22.18

RF (IN) (MHz)	LO (MHz)	RF-IF ISOLATION (dB)		
		@LO (dBm)		
		+10	+13	+16
10.1	40.1	26.18	25.55	25.48
90.3	120.3	25.73	25.51	25.42
170.6	200.6	25.96	25.90	25.90
250.8	280.8	26.50	26.47	26.50
331.0	361.0	27.09	27.23	27.16
411.3	441.3	28.02	28.16	27.89
491.5	521.5	28.98	28.96	28.85
571.8	601.8	30.00	29.68	29.51
652.0	682.0	31.30	30.70	30.42
732.2	762.2	32.76	32.11	31.48
812.5	842.5	34.10	33.70	32.99
892.7	922.7	35.69	35.34	34.70
972.9	1002.9	36.76	36.31	35.71
1053.2	1083.2	37.82	37.41	36.82
1133.4	1163.4	38.62	37.85	37.40
1233.7	1263.7	40.18	39.10	38.53
1313.9	1343.9	41.62	39.81	38.77
1414.2	1444.2	42.23	39.60	38.47
1494.5	1524.5	41.83	39.01	37.91
1594.8	1624.8	42.12	38.72	37.64
1675.0	1705.0	44.83	40.85	38.89
1775.3	1805.3	49.37	43.83	41.12
1855.5	1885.5	51.90	45.18	42.18
1955.8	1985.8	46.45	44.16	41.98
2036.1	2066.1	42.99	42.86	40.89
2136.4	2166.4	40.58	41.91	40.93
2216.6	2246.6	39.42	40.67	40.44
2316.9	2346.9	38.69	39.13	39.23
2397.1	2427.1	38.13	38.18	38.44
2497.4	2527.4	36.27	36.21	36.31
2577.7	2607.7	34.62	34.44	34.91
2678.0	2708.0	32.63	32.43	32.91
2758.2	2788.2	31.03	30.85	31.25
2858.5	2888.5	29.72	29.71	29.91
2938.7	2968.7	28.68	28.95	29.21
3039.0	3069.0	26.80	27.49	27.70
3119.3	3149.3	25.36	26.08	26.46
3219.6	3249.6	23.95	24.51	25.02
3299.8	3329.8	23.16	23.67	24.23
3400.1	3430.1	22.48	22.91	23.50



Frequency Mixer

SYM-25DMHW+

Typical Performance Data

RF (IN) (MHz)	LO (MHz)	RF VSWR (:1)		
		@LO (dBm)		
		+10	+13	+16
10.1	40.1	1.26	1.10	1.03
90.3	120.3	1.32	1.15	1.07
170.6	200.6	1.35	1.21	1.13
250.8	280.8	1.41	1.26	1.19
331.0	361.0	1.47	1.31	1.25
411.3	441.3	1.57	1.40	1.32
491.5	521.5	1.66	1.48	1.40
571.8	601.8	1.71	1.53	1.45
652.0	682.0	1.80	1.61	1.52
732.2	762.2	1.88	1.68	1.58
812.5	842.5	1.95	1.73	1.64
892.7	922.7	2.04	1.81	1.70
972.9	1002.9	2.11	1.86	1.74
1053.2	1083.2	2.19	1.92	1.79
1133.4	1163.4	2.27	1.99	1.83
1233.7	1263.7	2.31	2.01	1.84
1313.9	1343.9	2.31	2.00	1.83
1414.2	1444.2	2.30	1.99	1.82
1494.5	1524.5	2.31	2.03	1.87
1594.8	1624.8	2.34	2.08	1.95
1675.0	1705.0	2.32	2.11	2.00
1775.3	1805.3	2.30	2.14	2.04
1855.5	1885.5	2.30	2.15	2.06
1955.8	1985.8	2.29	2.15	2.05
2036.1	2066.1	2.20	2.06	1.96
2136.4	2166.4	2.03	1.88	1.78
2216.6	2246.6	1.93	1.78	1.67
2316.9	2346.9	1.79	1.66	1.57
2397.1	2427.1	1.66	1.54	1.45
2497.4	2527.4	1.53	1.41	1.32
2577.7	2607.7	1.48	1.37	1.29
2678.0	2708.0	1.45	1.37	1.31
2758.2	2788.2	1.43	1.36	1.31
2858.5	2888.5	1.43	1.38	1.36
2938.7	2968.7	1.47	1.44	1.43
3039.0	3069.0	1.51	1.48	1.49
3119.3	3149.3	1.51	1.49	1.50
3219.6	3249.6	1.56	1.55	1.58
3299.8	3329.8	1.64	1.64	1.68
3400.1	3430.1	1.72	1.73	1.77

LO (MHz)	LO VSWR (:1)		
	@LO (dBm)		
	+10	+13	+16
10.1	1.05	1.49	2.20
90.3	1.07	1.48	2.12
170.6	1.12	1.48	2.12
250.8	1.17	1.47	2.12
331.0	1.24	1.46	2.08
411.3	1.28	1.40	1.99
491.5	1.33	1.35	1.89
571.8	1.40	1.32	1.82
652.0	1.47	1.30	1.75
732.2	1.56	1.27	1.67
812.5	1.66	1.25	1.60
892.7	1.73	1.24	1.52
972.9	1.78	1.21	1.45
1053.2	1.82	1.19	1.38
1133.4	1.83	1.16	1.32
1233.7	1.83	1.13	1.29
1313.9	1.81	1.13	1.29
1414.2	1.76	1.15	1.35
1494.5	1.70	1.19	1.41
1594.8	1.63	1.24	1.53
1675.0	1.56	1.29	1.62
1775.3	1.46	1.36	1.74
1855.5	1.40	1.41	1.84
1955.8	1.33	1.48	1.94
2036.1	1.30	1.55	2.04
2136.4	1.27	1.62	2.14
2216.6	1.27	1.69	2.23
2316.9	1.29	1.76	2.30
2397.1	1.33	1.81	2.34
2497.4	1.40	1.87	2.38
2577.7	1.45	1.89	2.39
2678.0	1.54	1.96	2.42
2758.2	1.62	2.00	2.43
2858.5	1.74	2.08	2.47
2938.7	1.84	2.14	2.50
3039.0	1.97	2.22	2.53
3119.3	2.08	2.30	2.58
3219.6	2.20	2.37	2.62
3299.8	2.29	2.44	2.67
3400.1	2.40	2.52	2.71

IF (OUT) (MHz)	IF VSWR @LO=2500.1MHz (:1)		
	@LO (dBm)		
	+10	+13	+16
10.0	1.48	1.25	1.08
30.2	1.38	1.17	1.03
50.4	1.43	1.20	1.08
70.6	1.43	1.22	1.09
90.8	1.43	1.21	1.07
111.0	1.45	1.22	1.08
131.2	1.43	1.21	1.07
151.4	1.41	1.20	1.07
171.6	1.40	1.19	1.06
191.8	1.39	1.18	1.06
212.0	1.42	1.20	1.06
232.2	1.43	1.21	1.08
252.4	1.45	1.23	1.09
272.7	1.44	1.23	1.10
292.9	1.43	1.22	1.09
313.1	1.43	1.21	1.07
333.3	1.44	1.21	1.08
353.5	1.44	1.22	1.08
373.7	1.44	1.23	1.09
393.9	1.44	1.23	1.09
434.3	1.44	1.22	1.08
454.5	1.43	1.21	1.08
494.9	1.46	1.24	1.10
515.1	1.46	1.24	1.10
555.5	1.43	1.22	1.09
575.7	1.44	1.23	1.10
616.1	1.48	1.27	1.14
636.3	1.47	1.26	1.13
676.7	1.46	1.25	1.13
696.9	1.48	1.27	1.16
737.3	1.53	1.32	1.19
757.6	1.52	1.31	1.18
798.0	1.51	1.31	1.20
818.2	1.53	1.34	1.23
858.6	1.57	1.37	1.25
878.8	1.57	1.37	1.25
919.2	1.58	1.39	1.28
939.4	1.60	1.41	1.31
979.8	1.64	1.44	1.33
1000.0	1.64	1.45	1.34

Harmonics Tables

RF HARMONICS ORDER

	(-dBm)	(-dBc)										
0	-	-	24	20	29	30	34	44	45	54	59	62
1	-	32	+0	32	15	50	28	52	50	47	45	58
2	77	49	38	56	45	49	52	59	56	62	59	62
3	>100	65	55	55	55	58	50	71	56	63	56	60
4	>100	79	69	62	66	61	67	62	69	65	71	72
5	>100	81	75	73	63	72	62	73	63	90	67	85
6	>100	86	93	85	88	81	82	78	80	81	90	90
7	>100	89	93	93	92	88	93	86	96	88	87	91
8	>100	>97	>97	>97	>97	>97	96	>97	>97	>97	89	92
9	>100	>97	>97	>97	>97	>97	>97	>97	>97	96	>97	>97
10	>100	>97	>97	>97	>97	>97	>97	>97	>97	>97	>97	>97
	RF CAL	0	1	2	3	4	5	6	7	8	9	10

LO HARMONICS ORDER

Test conditions: RF IN: 1270.1 MHz; 4.00 dBm.
 LO IN: 1300.01 MHz; +13.00 dBm
 IF OUT: 29.91 MHz; -3.02 dBm

RF HARMONICS ORDER

	(-dBm)	(-dBc)										
0	-	-	12	11	18	19	22	32	31	41	37	46
1	-	33	+0	34	15	44	27	47	51	42	42	53
2	89	57	48	59	53	55	62	62	61	66	63	66
3	>100	77	75	77	68	75	65	85	69	>87	70	86
4	>100	>87	>87	>87	>87	81	>87	>87	>87	>87	>87	>87
5	>100	>87	>87	>87	>87	>87	>87	>87	>87	>87	>87	>87
6	>100	>87	>87	>87	>87	>87	>87	>87	>87	>87	>87	>87
7	>100	>87	>87	>87	>87	>87	>87	>87	>87	>87	>87	>87
8	>100	>87	>87	>87	>87	>87	>87	>87	>87	>87	>87	>87
9	>100	>87	>87	>87	>87	>87	>87	>87	>87	>87	>87	>87
10	>100	>87	>87	>87	>87	>87	>87	>87	>87	>87	>87	>87
	RF CAL	0	1	2	3	4	5	6	7	8	9	10

LO HARMONICS ORDER

Test conditions: RF IN: 1270.1 MHz; -6.00 dBm.
 LO IN: 1300.01 MHz; +13.00 dBm
 IF OUT: 29.91 MHz; -13.06 dBm

- Notes: 1. All Harmonics are in (dBc) relative to IF OUTPUT.
 2. + entry denotes harmonics are in (dBc) above IF OUTPUT.
 3. RF Cal represent the Harmonics level of the RF input signal to the mixer.

REV. X2
 SYM-25DMHW+
 100818
 Page 5 of 5



IF/RF MICROWAVE COMPONENTS • ISO 9001 ISO 14001 AS 9100 CERTIFIED • RoHS compliant
 P.O. Box 350166, Brooklyn, New York 11235-0006 (718) 934-4500 Fax (718) 332-4661



The Design Engineers Search Engine finds the model you need, Instantly • For detailed performance specs & shopping online see minicircuits.com

Frequency Mixer

SYM-25DMHW+

Typical Performance Curves

Conversion Loss @ IF=30MHz

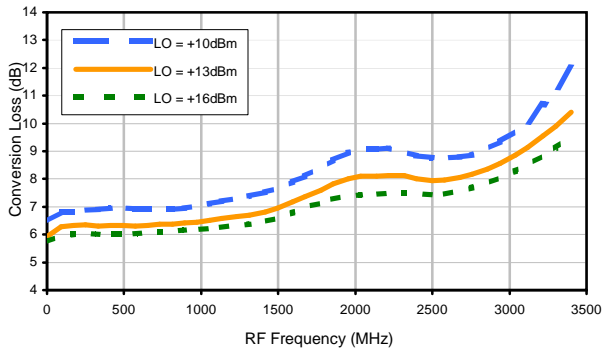

Conversion Loss vs. IF @ RF=1250.1MHz

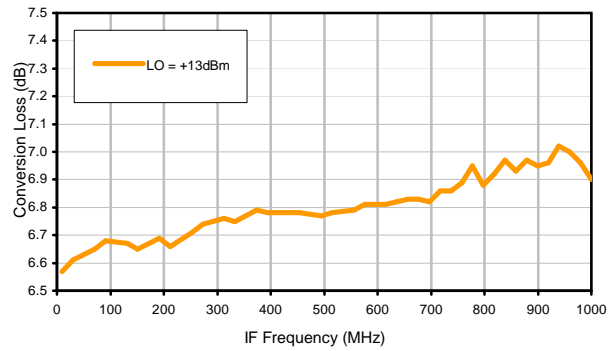

Conversion Loss vs. IF @ RF=40.1MHz

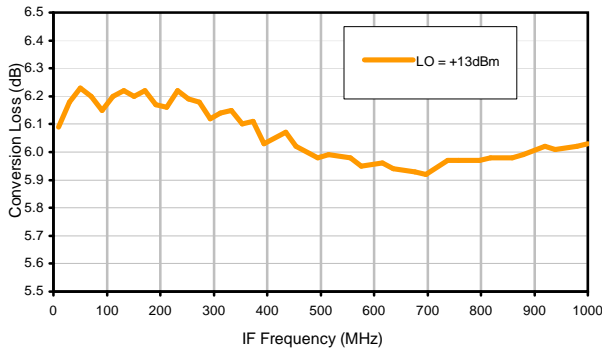

Conversion Loss vs. IF @ RF=2500.1MHz

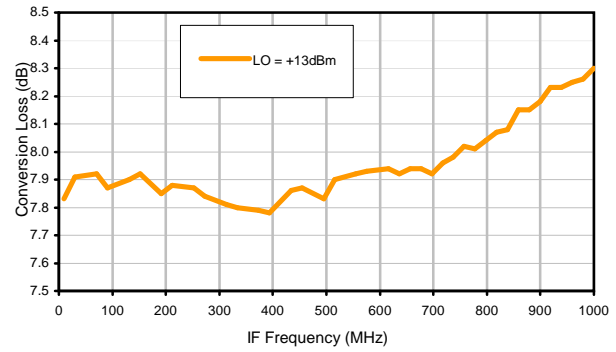

IP3 Input

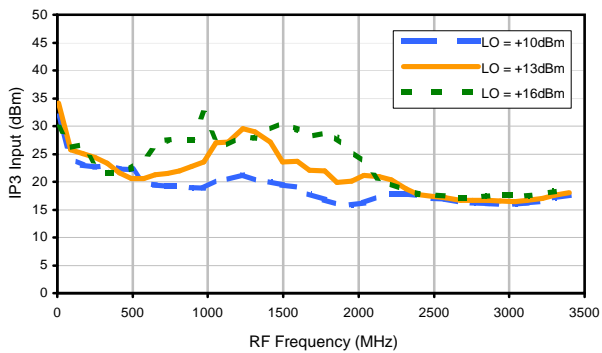

Compression @ RF IN=+9dBm

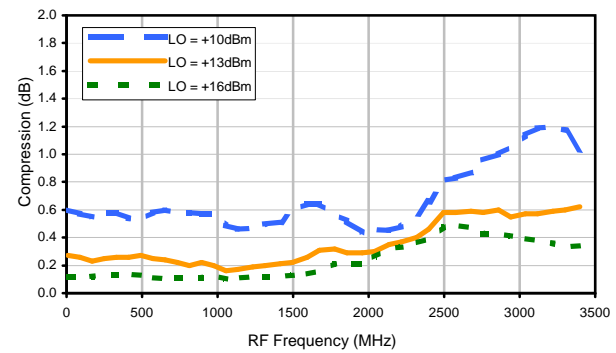

Typical Performance Curves

LO-RF Isolation

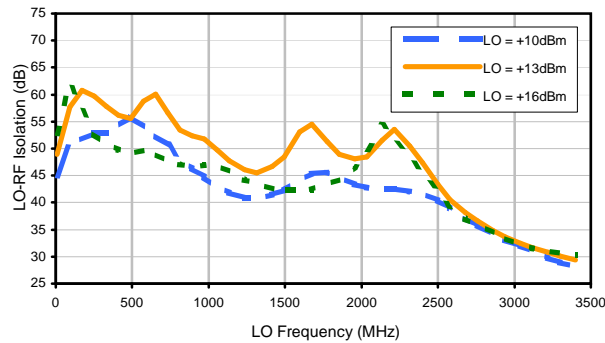

LO-IF Isolation

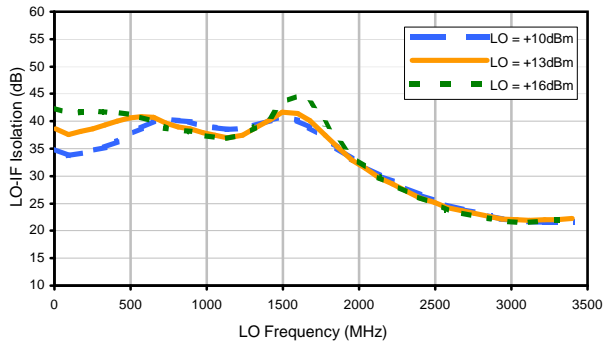

RF-IF Isolation

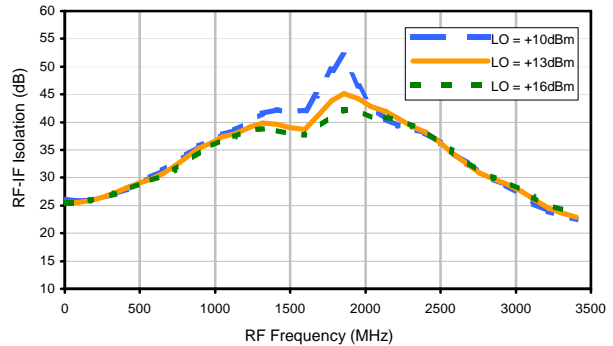

RF VSWR

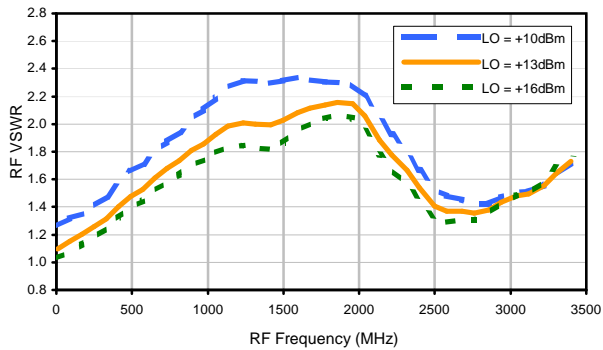

LO VSWR

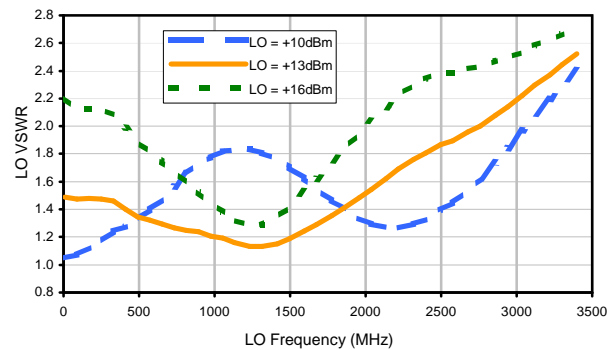

IF VSWR

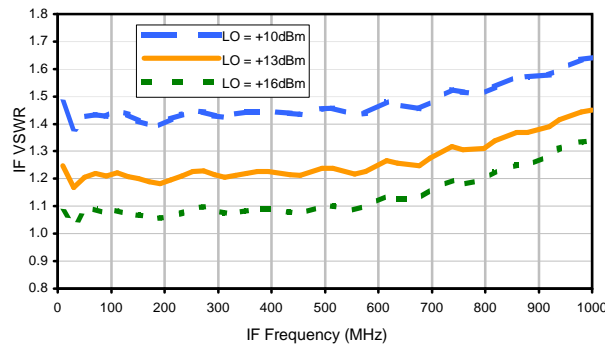

Harmonics Tables

RF HARMONICS ORDER

	(-dBm)	(-dBc)										
0	-	-	24	20	29	30	34	44	45	54	59	62
1	-	32	+0	32	15	50	28	52	50	47	45	58
2	77	49	38	56	45	49	52	59	56	62	59	62
3	>100	65	55	55	55	58	50	71	56	63	56	60
4	>100	79	69	62	66	61	67	62	69	65	71	72
5	>100	81	75	73	63	72	62	73	63	90	67	85
6	>100	86	93	85	88	81	82	78	80	81	90	90
7	>100	89	93	93	92	88	93	86	96	88	87	91
8	>100	>97	>97	>97	>97	>97	96	>97	>97	>97	89	92
9	>100	>97	>97	>97	>97	>97	>97	>97	>97	96	>97	>97
10	>100	>97	>97	>97	>97	>97	>97	>97	>97	>97	>97	>97
	RF CAL	0	1	2	3	4	5	6	7	8	9	10

LO HARMONICS ORDER

Test conditions: RF IN: 1270.1 MHz; 4.00 dBm.
 LO IN: 1300.01 MHz; +13.00 dBm
 IF OUT: 29.91 MHz; -3.02 dBm

RF HARMONICS ORDER

	(-dBm)	(-dBc)										
0	-	-	12	11	18	19	22	32	31	41	37	46
1	-	33	+0	34	15	44	27	47	51	42	42	53
2	89	57	48	59	53	55	62	62	61	66	63	66
3	>100	77	75	77	68	75	65	85	69	>87	70	86
4	>100	>87	>87	>87	>87	81	>87	>87	>87	>87	>87	>87
5	>100	>87	>87	>87	>87	>87	>87	>87	>87	>87	>87	>87
6	>100	>87	>87	>87	>87	>87	>87	>87	>87	>87	>87	>87
7	>100	>87	>87	>87	>87	>87	>87	>87	>87	>87	>87	>87
8	>100	>87	>87	>87	>87	>87	>87	>87	>87	>87	>87	>87
9	>100	>87	>87	>87	>87	>87	>87	>87	>87	>87	>87	>87
10	>100	>87	>87	>87	>87	>87	>87	>87	>87	>87	>87	>87
	RF CAL	0	1	2	3	4	5	6	7	8	9	10

LO HARMONICS ORDER

Test conditions: RF IN: 1270.1 MHz; -6.00 dBm.
 LO IN: 1300.01 MHz; +13.00 dBm
 IF OUT: 29.91 MHz; -13.06 dBm

- Notes: 1. All Harmonics are in (dBc) relative to IF OUTPUT.
 2. + entry denotes harmonics are in (dBc) above IF OUTPUT.
 3. RF Cal represent the Harmonics level of the RF input signal to the mixer.

REV. X2
 SYM-25DMHW+
 100818
 Page 3 of 3



IF/RF MICROWAVE COMPONENTS • ISO 9001 ISO 14001 AS 9100 CERTIFIED • RoHS compliant
 P.O. Box 350166, Brooklyn, New York 11235-0006 (718) 934-4500 Fax (718) 332-4661



The Design Engineers Search Engine finds the model you need, Instantly • For detailed performance specs & shopping online see minicircuits.com

Outline Dimensions

TTT166
TTT167

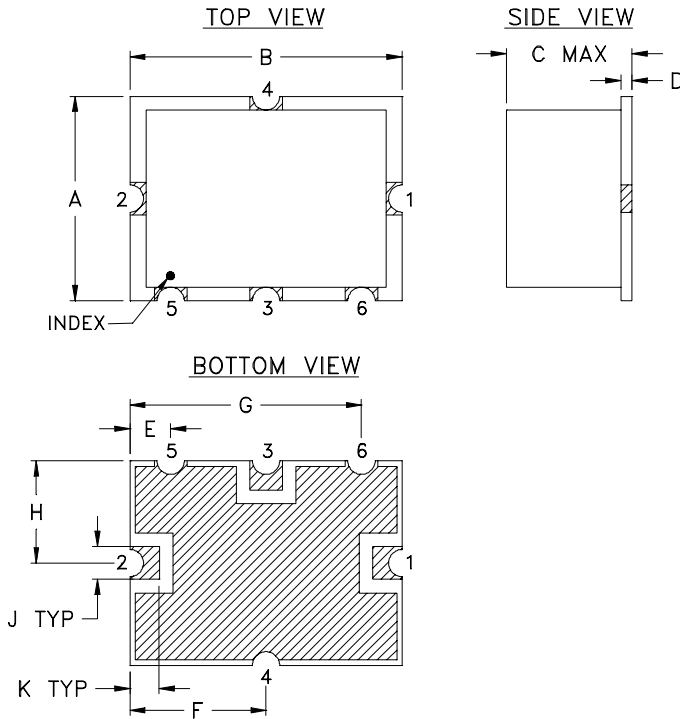

PCB Land Pattern

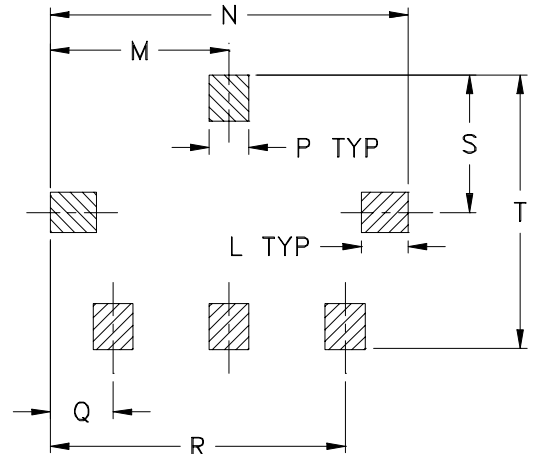

Suggested Layout,
Tolerance to be within $\pm .002$

CASE #	A	B	C	D	E	F	G	H	J	K	L	M	N
TTT166	.38 (9.65)	.50 (12.70)	.15 (3.81)	.020 (0.51)	.075 (1.91)	.250 (6.35)	.425 (10.80)	.187 (4.75)	.050 (1.27)	.050 (1.27)	.070 (1.78)	.270 (6.86)	.540 (13.72)
TTT167			.23 (5.84)										

CASE #	P	Q	R	S	T	WT. GRAM
TTT166	.060 (1.52)	.095 (2.41)	.445 (11.30)	.208 (5.28)	.415 (10.54)	.8
TTT167						.8

Dimensions are in inches (mm). Tolerances: 2 Pl. $\pm .01$; 3 Pl. $\pm .005$

Note:

- Case material: Plastic.
- Base material: Printed wiring laminate.
- Termination finish:
 - For RoHS Case Styles: 3-5 μ inch (.08-.13 microns) Gold over 120-240 μ inch (3.05-6.10 microns) Nickel plate. All models, (+) suffix.
 - For RoHS-5 Case Styles: Tin-Lead plate. All models, no (+) suffix.

Tape & Reel Packaging TR-F12

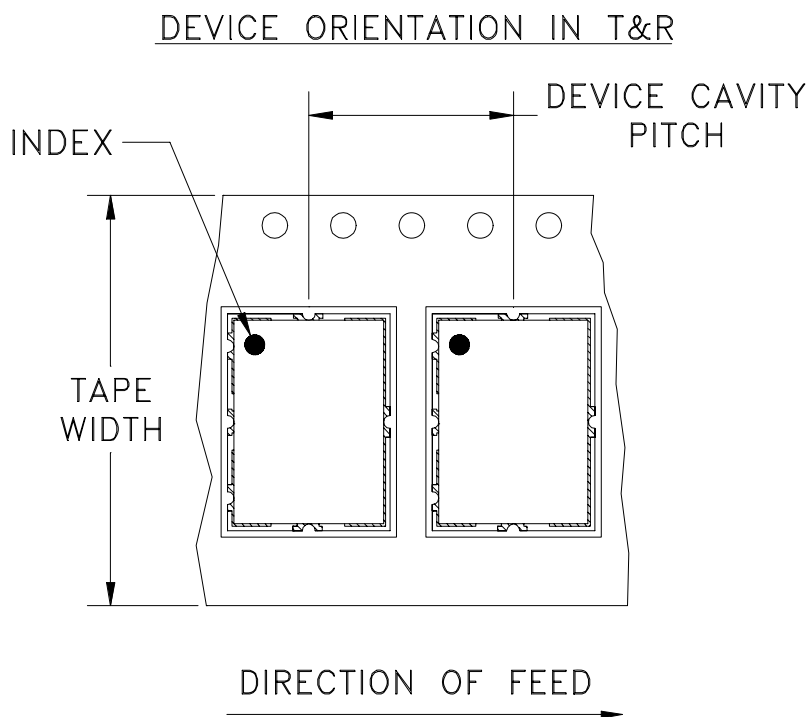

Tape Width, mm	Device Cavity Pitch, mm	Reel Size, inches	Devices per Reel	
24	12	7	Small quantity standards (see note)	10
				20
				50
				100
				200
		13	Standard	500

Note: Please Consult individual model data sheet to determine device per reel availability.

Mini-Circuits carrier tape materials provide protection from ESD (Electro-Static Discharge) during handling and transportation. Tapes are static dissipative and comply with industry standards EIA-481/EIA-541.

Go to: www.minicircuits.com/pages/pdfs/tape.pdf

Mini-Circuits[®]

Distribution Centers NORTH AMERICA 800-654-7949 • 417-335-5935 • Fax 417-335-5945 • EUROPE 44-1252-832600 • Fax 44-1252-837010

Mini-Circuits ISO 9001 & ISO 14001 Certified

INTERNET <http://www.minicircuits.com>

P.O. Box 350166, Brooklyn, New York 11235-0003 (718) 934-4500 Fax (718) 332-4661

THIRD ANGLE PROJECTION

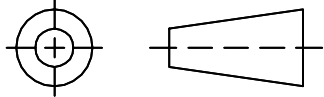

REVISIONS

REV	ECN No.	DESCRIPTION	DATE	DR	AUTH
A	M86762	ADDED CONNECTIONS "lp & lq"	05/23/03	MMG	WL
B	M94598	ADDED CONNECTION "hk"	10/08/04	MMG	HY
C	M102713	UPDATED NOTES & DESCRIPTION	01/14/06	GF	IL
D	M132989	UPDATED NOTE 2	08/24/11	GF	DJ

SUGGESTED MOUNTING CONFIGURATION FOR
TTT166/167 CASE STYLE, "hk"/"lp"/"lq"
"x"/"ck"/"ec" PIN CONNECTIONS

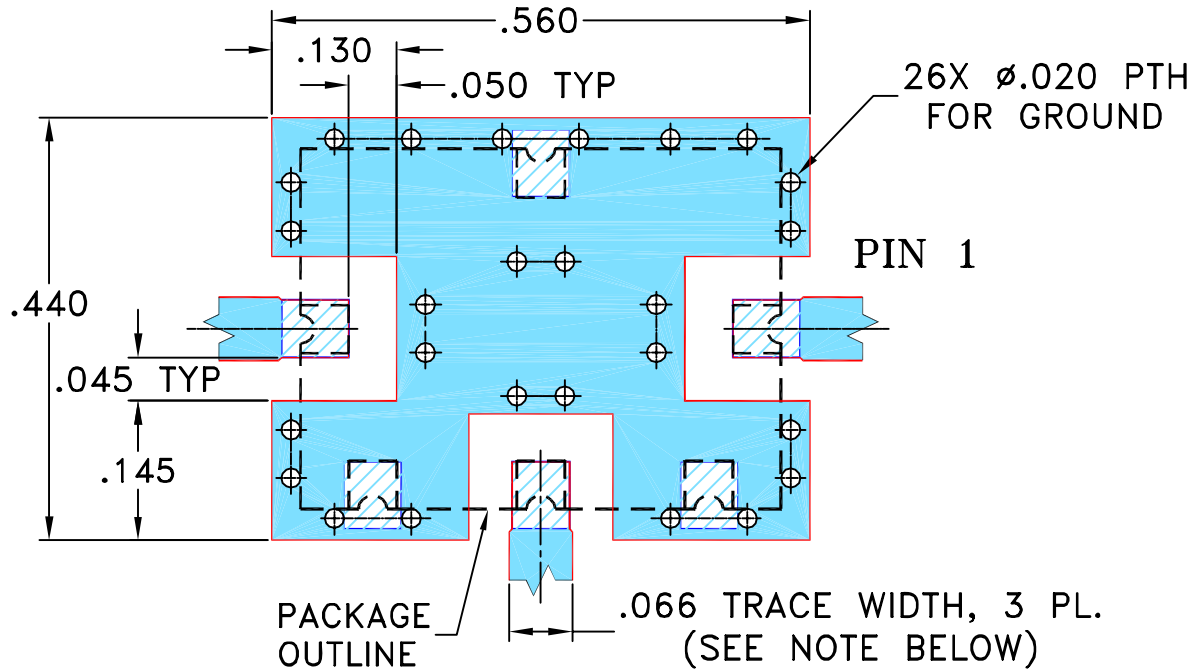

NOTE:

1. TRACE WIDTH IS SHOWN FOR ROGERS R04350B WITH DIELECTRIC THICKNESS .030" ± .002"; COPPER: 1/2 OZ. EACH SIDE. FOR OTHER MATERIALS TRACE WIDTH MAY NEED TO BE MODIFIED.
2. THE USE OF SOLDER MASK OVER THE GROUND AREA UNDER THE UNIT AS SHOWN IS RECOMMENDED TO PREVENT POTENTIAL SHORTING. IF USER CHOOSES TO EXPOSE METAL UNDER THE ENTIRE UNIT GROUND PAD FOR IMPROVED GROUNDING, IT IS RECOMMENDED A SOLDER MASK DAM BE APPLIED AROUND EACH GROUND PAD TO ENSURE FILLET AND CONNECTION AT GROUND PADS.
3. BOTTOM SIDE OF THE PCB IS CONTINUOUS GROUND PLANE.



DENOTES PCB COPPER LAYOUT WITH SMOBC (SOLDER MASK OVER BARE COPPER), SEE NOTE 2.

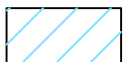

DENOTES COPPER LAND PATTERN FREE OF SOLDER MASK

UNLESS OTHERWISE SPECIFIED

DIMENSIONS ARE IN INCHES
TOLERANCES ON:
2 PL DECIMALS ±
3 PL DECIMALS ± .005
ANGLES ±
FRACTIONS ±

	INITIALS	DATE
DRAWN	GF	03/18/03
CHECKED	IL	04/15/03
APPROVED	DJ	04/15/03



Mini-Circuits®

13 Neptune Avenue
Brooklyn NY 11235

PL, hk/lp/lq/x/ck/ec, TTT166/167,
SYM/HJK/SYAS/SYPD, TB-12

Mini-Circuits®
THIS DOCUMENT AND ITS CONTENTS ARE THE PROPERTY OF MINI-CIRCUITS. EXCEPT FOR USE EXPRESSLY GRANTED, IN WRITING, TO ITS VENDORS, VENDEE AND THE UNITED STATES GOVERNMENT, MINI-CIRCUITS RESERVES ALL PROPRIETARY DESIGN, USE, MANUFACTURING AND REPRODUCTION RIGHTS THERETO. THESE CONTENTS SHALL NOT BE USED, DUPLICATED OR DISCLOSED TO ANY OUTSIDE PARTY, IN WHOLE OR IN PART, WITHOUT WRITTEN PERMISSION OF MINI-CIRCUITS.

SIZE	CODE IDENT	DRAWING NO:	REV:
A	15542	98-PL-079	D
FILE:	98PL079	SCALE: 5:1	SHEET: 1 OF 1

Evaluation Board and Circuit

For Pin Connections Refer to Data Sheet of the DUT

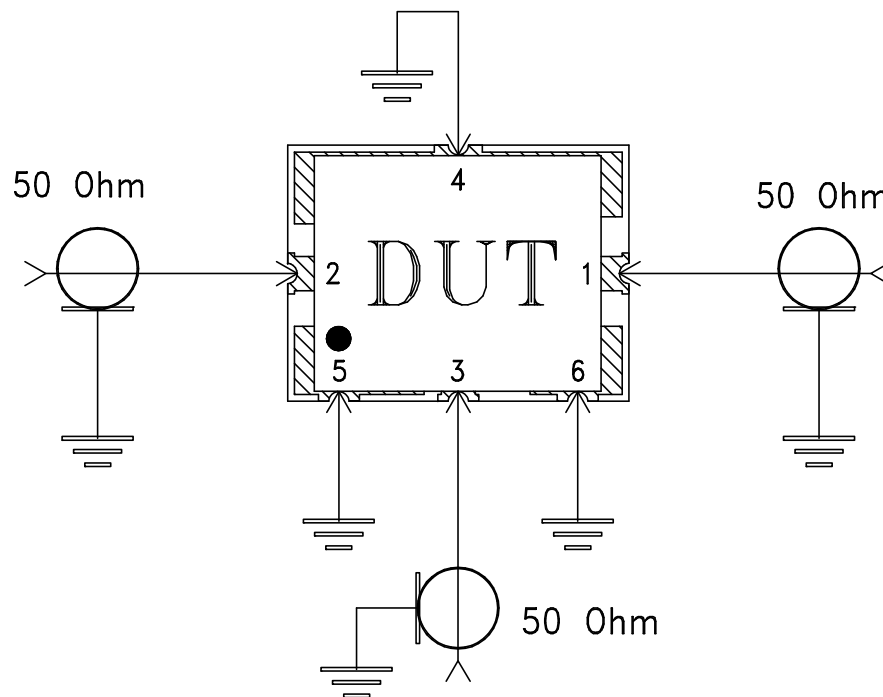
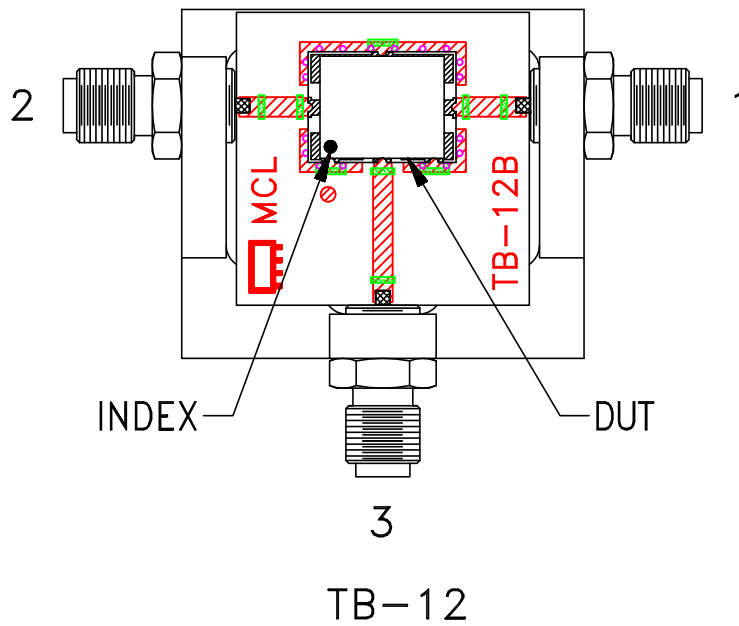

Schematic Diagram

Notes:

1. SMA Female connectors.
2. PCB Material: Rogers R04350 or equivalent, Dielectric Constant=3.5, Thickness=.030 inch.

 **Mini-Circuits®**

All Mini-Circuits products are manufactured under exacting quality assurance and control standards, and are capable of meeting published specifications after being subjected to any or all of the following physical and environmental test.

Specification	Test/Inspection Condition	Reference/Spec
Operating Temperature	-40° to 85°C Ambient Environment	Individual Model Data Sheet
Storage Temperature	-55° to 100° C Ambient Environment	Individual Model Data Sheet
Humidity	90 to 95% RH, 240 hours, 50°C	MIL-STD-202, Method 103, Condition A, Except 50°C and end-point electrical test done within 12 hours
Thermal Shock	-55° to 100°C, 100 cycles	MIL-STD-202, Method 107, Condition A-3, except +100°C
Solder Reflow Heat	Sn-Pb Eutetic Process: 225°C peak Pb-Free Process 245° - 250°C peak	J-STD-020, Table 4-1, 4-2 and 5-2, Figure 5-1
Solderability	10X Magnification	J-STD-002, 95% Coverage
Vibration (High Frequency)	20g peak, 10-2000 Hz, 12 times in each of three perpendicular directions (total 36)	MIL-STD-202, Method 204, Condition D
Mechanical Shock	50g, 11 ms, 1/2-sine, 18 shocks: 3 each direction, each of 3 axes	MIL-STD-202, Method 213, Condition A
Marking Resistance to Solvents	Isopropyl alcohol + mineral spirits at 25°C; terpene defluxer at 25°C; distilled water + proylene glycol monomethyl ether + monoethanolamine at 63°C to 70°C	MIL-STD-202, Method 215