

Features

- Operates DC - 4 GHz on Single Supply
- ASIC TTL / CMOS Driver
- Leadless 4 x 6 mm Chip Scale Plastic Package
- Low DC Power Consumption
- 50 Ohm Nominal Impedance
- Test Boards are Available
- Tape and Reel are Available

Description

M/A-COM's SW90-0002 is a SPDT absorptive pHEMT switch with integral TTL driver. This device is in an MLP plastic surface mount package. This switch offers excellent broadband performance and repeatability from DC to 4 GHz, while maintaining low DC power dissipation. The SW90-0002 is ideally suited for wireless infrastructure applications.

CSP-1

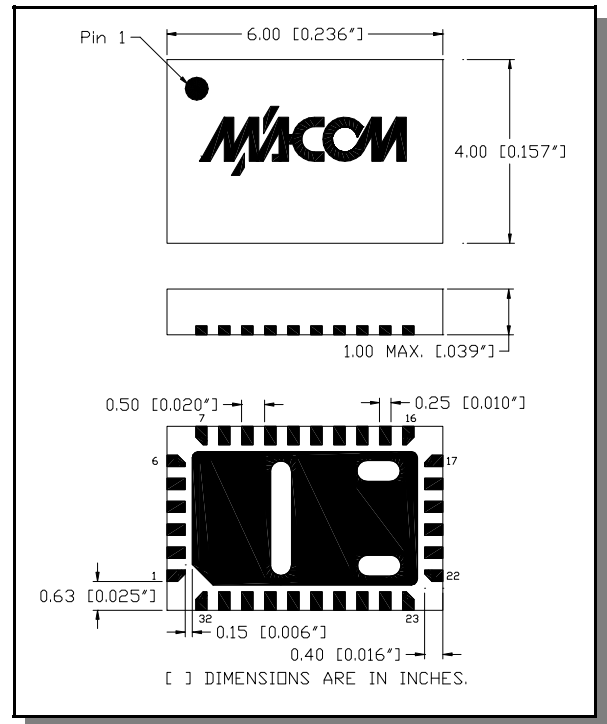

Electrical Specifications: $T_A = 25^\circ\text{C}$

Parameter	Test Conditions	Frequency	Units	Min.	Typ.	Max.
Insertion Loss	RFC—RF1,RF2 (Logic per truth table)	DC - 4.0 GHz	dB	—	—	1.8
Isolation	RF1—RF2 (All Logic "0")	DC - 4.0 GHz	dB	30	—	—
VSWR	On (RFC,RF1, RF2) (Logic per truth table)	DC - 4.0 GHz	Ratio	—	—	2.0:1
VSWR	Off (RF1, RF2) (Logic per truth table)	DC - 4.0 GHz	Ratio	—	—	1.8:1
1 dB Compression	— —	50 MHz	dBm	—	18	—
		0.5 - 4.0 GHz	dBm	—	29	—
Input IP_3	Two-tone inputs up to +5 dBm	50 MHz	dBm	—	36	—
		0.5 - 4.0 GHz	dBm	—	46	—
Switching Speed	Ton (50% Control to 10% RF)		nS	—	31	—
	Toff (50% Control to 90% RF)		nS	—	19	—
	Trise (10% to 90% RF)		nS	—	6	—
	Tfall (90% to 10% RF)		nS	—	2	—
Vcc	—	—	V	4.5	5.0	5.5
Logic "0"	Sink Current is 20 μA max.	—	V	0.0	—	0.8
Logic "1"	Source Current is 20 μA max.	—	V	2.0	—	5.0
Icc	Vcc min to max, Logic "0" or "1"	—	mA	—	5	8

Pin Configuration ^{1,2,3}

Pin No.	Function	Pin No.	Function
1	NC	17	NC
2	GND	18	C1
3	RFC	19	NC
4	GND	20	V _{CC}
5	NC	21	NC
6	NC	22	NC
7	GND	23	CP1
8	RF1	24	CP2
9	GND	25	NC
10	NC	26	V _{EE}
11	NC	27	NC
12	V _{EE}	28	NC
13	NC	29	NC
14	V _{CC}	30	GND
15	NC	31	RF2
16	NC	32	GND

1. NC = No Connection
2. V_{EE} is internally generated and must remain isolated from external power supplies.
3. Connections and external components shown in functional schematic are required. 0.1 μ F Capacitors need to be located near pins 20 & 26.

Functional Schematic

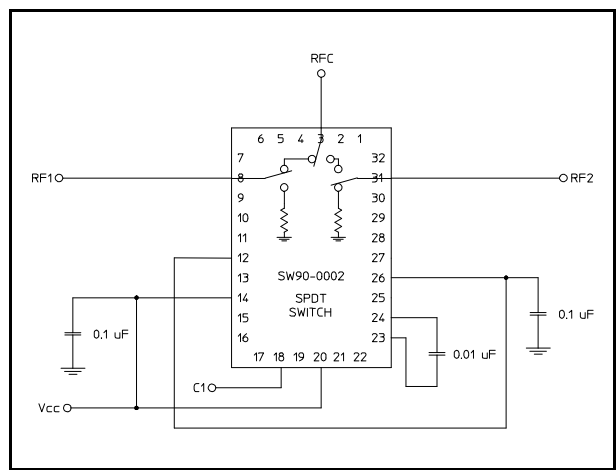
Absolute Maximum Ratings ^{4,5}

Parameter	Absolute Maximum
Max. Input Power 0.05 GHz 0.5 - 4.0 GHz	+27 dBm +34 dBm
Bias Voltages V _{CC} Control Voltage ⁶	+5.5V -0.5V to V _{CC} +0.5V
Operating Temperature	-40°C to +85°C
Storage Temperature	-65°C to +125°C

4. Operation of this device above any one of these parameters may cause permanent damage.
5. When the RF input is applied to the terminated port, the absolute maximum power is +30 dBm.
6. Standard CMOS TTL interface, latch-up will occur if logic signal is applied prior to power supply.

Truth Table

Control Input	Condition of the Switch	
	RF Common to each RF Port	
C1	RF1	RF2
0	Off	On
1	On	Off

"0" = TTL Low "1" = TTL High

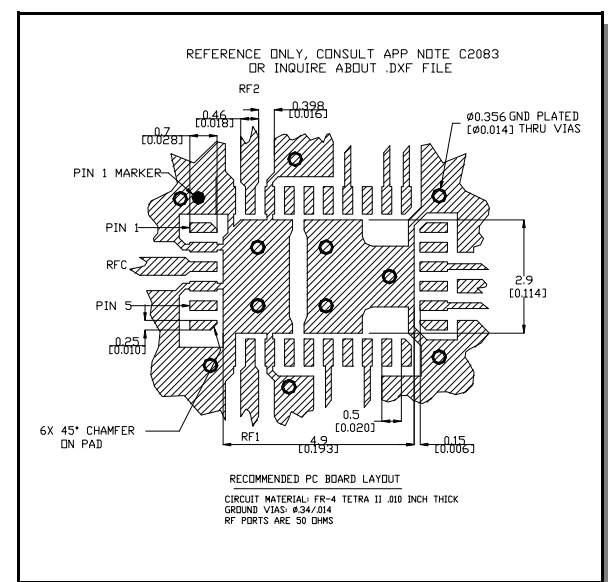
Recommended PCB Layout ⁷

7. Application Note C2083 is available on line at www.macom.com

Specifications subject to change without notice.

- North America: Tel. (800) 366-2266
- Asia/Pacific: Tel. +81-44-844-8296, Fax +81-44-844-8298
- Europe: Tel. +44 (1344) 869 595, Fax +44 (1344) 300 020

Visit www.macom.com for additional data sheets and product information.

Typical Performance Curves

Insertion Loss vs. Frequency

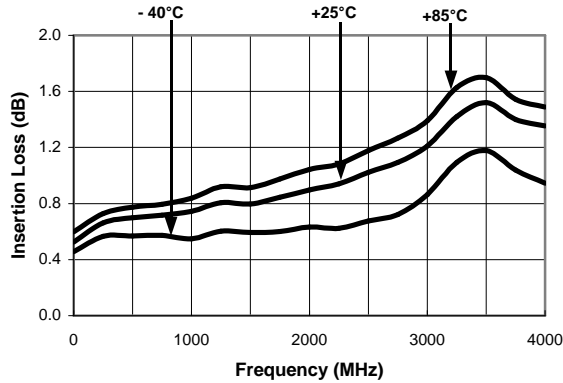

Isolation (dB) vs. Frequency

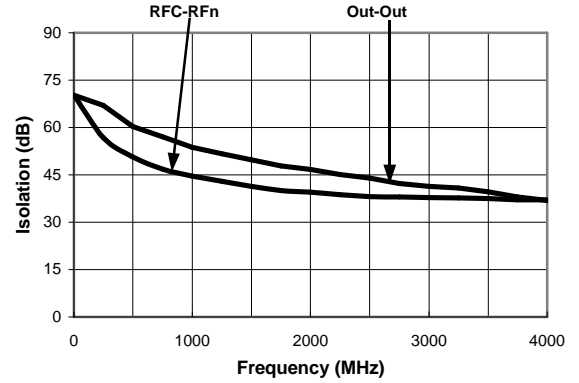

On VSWR vs. Frequency

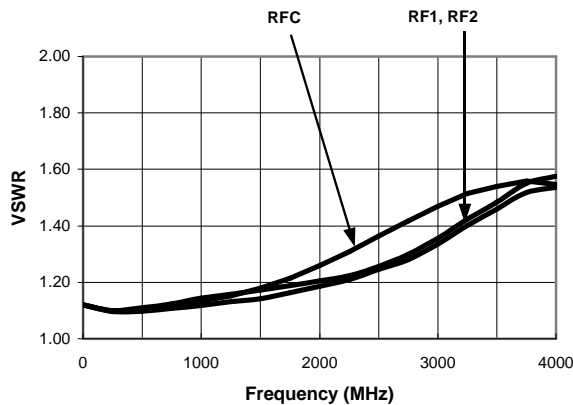

VSWR (Terminations) vs. Frequency

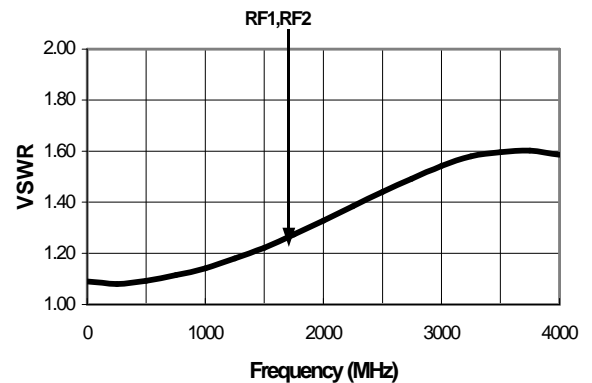

Ordering Information

Part Number	Package
SW90-0002	Bulk Packaging
SW90-0002TR	Tape and Reel (1K Reel)
SW90-0002-TB	Units Mounted on Test Board

Specifications subject to change without notice.

- North America: Tel. (800) 366-2266
- Asia/Pacific: Tel.+81-44-844-8296, Fax +81-44-844-8298
- Europe: Tel. +44 (1344) 869 595, Fax+44 (1344) 300 020

Visit www.macom.com for additional data sheets and product information.