

Power Splitter/Combiner

SCP-4-1W+

4 Way-0° 50Ω

10 to 650 MHz

Maximum Ratings

Operating Temperature	-40°C to 85°C
Storage Temperature	-55°C to 100°C
Power Input (as a splitter)	1W max.
Internal Dissipation	0.25W max.

Permanent damage may occur if any of these limits are exceeded.

Pin Connections

SUM PORT	3
PORT 1	2
PORT 2	4
PORT 3	6
PORT 4	8
GROUND	1,5,7

Outline Drawing

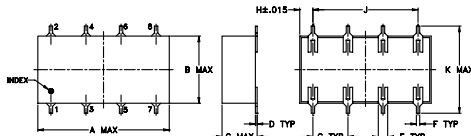

PCB Land Pattern

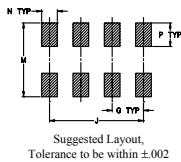

Outline Dimensions (inch/mm)

A	B	C	D	E	F	G	H	J	K	M	N	P	wt
.75	.38	.20	.010	.050	.020	.200	.075	.600	.450	.470	.100	.150	grams
19.05	9.65	5.08	0.25	1.27	0.51	5.08	1.91	15.24	11.43	11.94	2.54	3.81	1.6

Demo Board MCL P/N: TB-36 Suggested PCB Layout (PL-073)

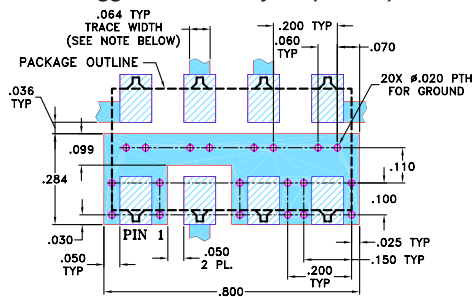

- NOTES: 1. TRACE WIDTH IS SHOWN FOR ROGERS RO4350B WITH DIELECTRIC THICKNESS 0.030" ± 0.002"; COPPER: 1/2 OZ. EACH SIDE. FOR OTHER MATERIALS TRACE WIDTH MAY NEED TO BE MODIFIED.
2. BOTTOM SIDE OF THE PCB IS CONTINUOUS GROUND PLANE.
■ DENOTES PCB COPPER LAYOUT WITH SMOBC (SOLDER MASK OVER BARE COPPER)
■ DENOTES COPPER LAND PATTERN FREE OF SOLDER MASK

Notes

- A. Performance and quality attributes and conditions not expressly stated in this specification document are intended to be excluded and do not form a part of this specification document.
B. Electrical specifications and performance data contained in this specification document are based on Mini-Circuit's applicable established test performance criteria and measurement instructions.
C. The parts covered by this specification document are subject to Mini-Circuits standard limited warranty and terms and conditions (collectively, "Standard Terms"); Purchasers of this part are entitled to the rights and benefits contained therein. For a full statement of the Standard Terms and the exclusive rights and remedies thereunder, please visit Mini-Circuits' website at www.minicircuits.com/MCLStore/terms.jsp

Features

- wideband, 10 to 650 MHz
- excellent amplitude unbalance, 0.4 dB typ.

Applications

- VHF/UHF
- receivers/transmitters
- federal and defense communication



Generic photo used for illustration purposes only

CASE STYLE: YY101

+RoHS Compliant

The +Suffix identifies RoHS Compliance. See our web site for RoHS Compliance methodologies and qualifications

Electrical Specifications

FREQ. RANGE (MHz)	ISOLATION (dB)			INSERTION LOSS (dB) ABOVE 6 dB			PHASE UNBALANCE (Degrees)			AMPLITUDE UNBALANCE (dB)								
	L	M	U	L	M	U	L	M	U	L	M	U						
f_L - f_U	Typ. Min.	Typ. Min.	Typ. Min.	Typ. Max.	Typ. Max.	Typ. Max.	Max.	Max.	Max.	Max.	Max.	Max.						
10-650	34	28	23	18	21	15	0.7	1.0	0.9	1.5	1.1	1.9	3	7	12	0.2	0.4	0.7

L = low range [f_L to $10 f_L$] M = mid range [$10 f_L$ to $f_U/2$] U = upper range [$f_U/2$ to f_U]

Typical Performance Data

Freq. (MHz)	Total Loss ¹ (dB)				Amp. Unbal. (dB)	Isolation (dB)			Phase Unbal. (deg.)	VSWR S	VSWR 1	VSWR 2	VSWR 3	VSWR 4
	S-1	S-2	S-3	S-4		1-2	2-3	3-4						
10.00	6.38	6.36	6.36	6.36	0.02	37.18	42.07	38.05	0.07	1.07	1.13	1.13	1.12	1.12
30.00	6.41	6.39	6.39	6.38	0.02	36.10	42.30	36.46	0.12	1.06	1.12	1.12	1.12	1.12
90.00	6.44	6.43	6.43	6.42	0.02	33.76	39.74	33.67	0.43	1.05	1.12	1.12	1.12	1.12
120.00	6.47	6.46	6.46	6.44	0.03	32.46	38.76	32.19	0.58	1.04	1.12	1.12	1.12	1.12
150.00	6.50	6.49	6.49	6.47	0.03	31.21	38.02	30.82	0.70	1.03	1.12	1.12	1.11	1.12
180.00	6.47	6.47	6.48	6.45	0.03	29.92	37.23	29.49	0.85	1.02	1.11	1.11	1.11	1.11
210.00	6.51	6.52	6.52	6.49	0.04	28.87	36.52	28.36	0.95	1.01	1.11	1.11	1.11	1.11
240.00	6.55	6.56	6.56	6.52	0.04	27.96	35.86	27.40	1.10	1.01	1.10	1.11	1.10	1.10
300.00	6.58	6.59	6.59	6.54	0.05	26.21	34.39	25.59	1.33	1.05	1.09	1.09	1.09	1.09
375.00	6.63	6.65	6.66	6.58	0.08	24.48	32.64	23.81	1.69	1.10	1.07	1.08	1.07	1.08
450.00	6.70	6.75	6.75	6.63	0.12	23.16	31.19	22.46	1.94	1.15	1.06	1.07	1.06	1.06
525.00	6.77	6.86	6.86	6.70	0.15	22.23	30.20	21.51	2.32	1.21	1.04	1.05	1.05	1.04
575.00	6.79	6.88	6.87	6.69	0.19	21.76	29.83	21.04	2.45	1.24	1.03	1.05	1.04	1.04
625.00	6.83	6.95	6.94	6.73	0.22	21.37	29.74	20.65	2.66	1.28	1.03	1.05	1.04	1.03
650.00	6.88	7.01	6.99	6.77	0.25	21.19	29.79	20.47	2.73	1.29	1.03	1.05	1.04	1.03

1. Total Loss = Insertion Loss + 6dB splitter loss.

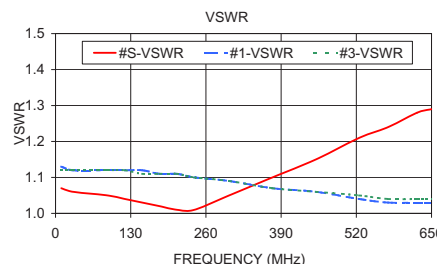
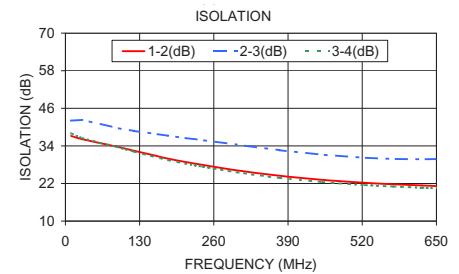
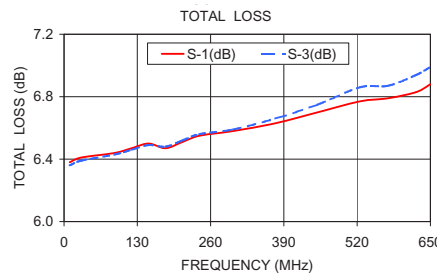

Electrical Schematic



4 Way-0° Power Splitter/Combiner

SCP-4-1W+

Typical Performance Data

TEST CONDITIONS: INPUT POWER = 0dBm @Temperature = +25°C

FREQ. (MHz)	TOTAL LOSS ¹ (dB)				AMP. UNBAL. (dB)	PHASE UNBAL. (deg.)	ISOLATION (dB)			VSWR (:1)				
	S-1	S-2	S-3	S-4			1-2	2-3	3-4	S	1	2	3	4
10	6.37	6.38	6.38	6.39	0.01	0.07	36.75	41.41	36.19	1.08	1.14	1.14	1.14	1.14
20	6.39	6.39	6.40	6.39	0.01	0.05	36.65	42.11	35.86	1.07	1.13	1.13	1.13	1.13
30	6.40	6.40	6.41	6.41	0.01	0.03	35.93	41.57	35.27	1.07	1.13	1.13	1.13	1.13
40	6.41	6.41	6.42	6.41	0.01	0.02	35.17	40.78	34.71	1.07	1.13	1.13	1.13	1.13
50	6.42	6.42	6.43	6.43	0.01	0.01	34.46	40.02	34.15	1.07	1.13	1.12	1.13	1.13
60	6.43	6.43	6.44	6.44	0.01	0.04	33.75	39.39	33.57	1.07	1.12	1.12	1.13	1.13
70	6.44	6.45	6.45	6.45	0.01	0.06	33.10	38.83	32.99	1.07	1.12	1.12	1.13	1.13
80	6.45	6.45	6.46	6.46	0.02	0.05	32.48	38.36	32.42	1.07	1.12	1.12	1.12	1.13
90	6.46	6.46	6.47	6.46	0.01	0.05	31.86	37.90	31.88	1.07	1.12	1.12	1.12	1.12
100	6.47	6.47	6.48	6.47	0.01	0.05	31.30	37.48	31.34	1.07	1.12	1.12	1.12	1.12
125	6.49	6.49	6.50	6.49	0.01	0.09	30.00	36.57	30.11	1.07	1.12	1.12	1.12	1.12
150	6.50	6.51	6.51	6.51	0.01	0.10	28.89	35.79	29.01	1.07	1.11	1.12	1.12	1.12
175	6.51	6.52	6.54	6.52	0.02	0.10	27.92	35.09	28.05	1.07	1.11	1.11	1.11	1.11
200	6.54	6.55	6.55	6.54	0.01	0.12	27.07	34.47	27.22	1.08	1.11	1.11	1.11	1.11
225	6.55	6.57	6.57	6.55	0.02	0.15	26.32	33.93	26.49	1.08	1.10	1.11	1.10	1.10
250	6.56	6.58	6.58	6.56	0.02	0.16	25.67	33.42	25.83	1.08	1.10	1.10	1.10	1.10
275	6.58	6.61	6.61	6.58	0.03	0.17	25.09	32.99	25.26	1.08	1.09	1.10	1.10	1.09
300	6.60	6.63	6.63	6.60	0.03	0.15	24.58	32.59	24.75	1.09	1.09	1.09	1.09	1.09
325	6.62	6.66	6.65	6.61	0.04	0.15	24.13	32.24	24.30	1.09	1.08	1.09	1.09	1.08
350	6.64	6.67	6.66	6.62	0.04	0.15	23.73	31.95	23.91	1.09	1.07	1.09	1.08	1.08
375	6.64	6.69	6.69	6.64	0.05	0.17	23.39	31.69	23.57	1.09	1.07	1.08	1.07	1.07
400	6.67	6.71	6.71	6.65	0.06	0.13	23.10	31.47	23.27	1.10	1.06	1.08	1.07	1.06
425	6.68	6.73	6.73	6.66	0.06	0.13	22.85	31.31	23.02	1.10	1.05	1.07	1.06	1.06
450	6.70	6.75	6.74	6.67	0.08	0.09	22.64	31.19	22.82	1.10	1.05	1.07	1.06	1.05
475	6.71	6.77	6.77	6.69	0.08	0.09	22.49	31.13	22.67	1.10	1.04	1.06	1.05	1.05
500	6.73	6.79	6.79	6.70	0.09	0.09	22.38	31.11	22.56	1.10	1.04	1.06	1.05	1.04
525	6.74	6.81	6.81	6.71	0.10	0.13	22.31	31.15	22.49	1.10	1.03	1.05	1.04	1.04
550	6.75	6.83	6.83	6.72	0.11	0.16	22.27	31.28	22.47	1.11	1.03	1.05	1.04	1.03
575	6.76	6.85	6.85	6.73	0.12	0.21	22.28	31.49	22.48	1.11	1.03	1.04	1.04	1.03
600	6.78	6.87	6.87	6.74	0.13	0.25	22.31	31.78	22.52	1.12	1.03	1.04	1.04	1.03
625	6.79	6.89	6.90	6.76	0.14	0.32	22.38	32.19	22.59	1.12	1.03	1.05	1.04	1.04
650	6.81	6.92	6.92	6.78	0.15	0.42	22.46	32.71	22.67	1.13	1.04	1.05	1.05	1.04
675	6.82	6.95	6.96	6.80	0.16	0.54	22.52	33.43	22.72	1.15	1.05	1.06	1.06	1.05
700	6.85	6.97	6.99	6.82	0.17	0.67	22.55	34.28	22.74	1.17	1.06	1.06	1.07	1.06
725	6.87	7.01	7.02	6.84	0.18	0.80	22.49	35.35	22.69	1.19	1.07	1.08	1.08	1.07
750	6.90	7.05	7.07	6.87	0.20	0.97	22.35	36.37	22.49	1.22	1.08	1.09	1.09	1.08
775	6.94	7.10	7.13	6.92	0.21	1.10	21.99	37.01	22.14	1.26	1.09	1.10	1.10	1.10
800	6.99	7.16	7.19	6.97	0.22	1.38	21.48	36.80	21.60	1.30	1.10	1.12	1.11	1.11
850	7.13	7.32	7.37	7.13	0.24	1.90	19.92	33.45	20.05	1.41	1.13	1.16	1.14	1.14
900	7.34	7.56	7.63	7.36	0.29	2.73	17.95	29.24	18.13	1.56	1.16	1.20	1.18	1.17
950	7.67	7.92	8.00	7.71	0.33	3.74	15.89	25.68	16.18	1.75	1.20	1.26	1.22	1.20
1000	8.14	8.43	8.50	8.20	0.35	5.50	13.96	22.79	14.43	1.98	1.24	1.32	1.25	1.24
1050	8.83	9.16	9.10	8.82	0.34	8.25	12.13	20.55	12.91	2.24	1.29	1.40	1.29	1.27

¹ Total Loss = Insertion Loss+ 6dB Splitter Loss



4 Way-0° Power Splitter/Combiner

SCP-4-1W+

Typical Performance Data

TEST CONDITIONS: INPUT POWER = 0dBm @Temperature = -40°C

FREQ. (MHz)	TOTAL LOSS ¹ (dB)				AMP. UNBAL. (dB)	PHASE UNBAL. (deg.)	ISOLATION (dB)			VSWR (:1)				
	S-1	S-2	S-3	S-4			1-2	2-3	3-4	S	1	2	3	4
10	6.38	6.38	6.38	6.39	0.02	0.09	33.14	40.31	33.32	1.11	1.20	1.19	1.19	1.20
20	6.33	6.33	6.34	6.34	0.01	0.10	37.83	42.28	38.17	1.08	1.13	1.12	1.12	1.13
30	6.33	6.33	6.34	6.34	0.01	0.07	38.63	42.35	38.95	1.07	1.11	1.10	1.10	1.11
40	6.33	6.33	6.34	6.34	0.01	0.11	37.94	41.78	38.34	1.07	1.10	1.10	1.09	1.10
50	6.34	6.34	6.34	6.34	0.01	0.09	36.96	41.14	37.39	1.06	1.10	1.09	1.09	1.10
60	6.35	6.34	6.35	6.35	0.01	0.14	35.98	40.60	36.37	1.06	1.09	1.09	1.09	1.09
70	6.35	6.35	6.36	6.35	0.00	0.13	35.06	40.09	35.44	1.06	1.09	1.09	1.09	1.09
80	6.36	6.36	6.36	6.36	0.00	0.18	34.17	39.60	34.53	1.06	1.09	1.09	1.09	1.09
90	6.37	6.37	6.37	6.36	0.01	0.19	33.39	39.15	33.72	1.06	1.09	1.09	1.09	1.08
100	6.37	6.37	6.37	6.37	0.00	0.23	32.67	38.73	32.99	1.06	1.08	1.09	1.09	1.08
125	6.39	6.39	6.39	6.38	0.01	0.26	31.10	37.75	31.38	1.07	1.08	1.09	1.09	1.08
150	6.40	6.40	6.40	6.39	0.01	0.34	29.80	36.89	30.05	1.07	1.08	1.08	1.08	1.07
175	6.41	6.41	6.42	6.40	0.01	0.40	28.70	36.14	28.93	1.08	1.07	1.07	1.07	1.07
200	6.43	6.43	6.43	6.42	0.02	0.44	27.76	35.47	27.97	1.09	1.07	1.08	1.07	1.07
225	6.45	6.46	6.45	6.44	0.02	0.51	26.94	34.84	27.15	1.10	1.07	1.08	1.07	1.07
250	6.46	6.47	6.46	6.44	0.03	0.61	26.21	34.29	26.42	1.10	1.07	1.08	1.07	1.07
275	6.48	6.49	6.48	6.45	0.03	0.64	25.58	33.77	25.78	1.11	1.06	1.07	1.07	1.06
300	6.49	6.50	6.50	6.47	0.04	0.67	25.03	33.32	25.21	1.11	1.06	1.07	1.06	1.06
325	6.51	6.53	6.52	6.48	0.05	0.74	24.54	32.90	24.72	1.11	1.06	1.07	1.06	1.06
350	6.52	6.54	6.53	6.48	0.06	0.81	24.10	32.55	24.29	1.12	1.05	1.06	1.06	1.05
375	6.53	6.55	6.55	6.50	0.06	0.89	23.74	32.24	23.92	1.12	1.05	1.06	1.05	1.05
400	6.55	6.57	6.56	6.50	0.06	0.94	23.41	31.97	23.59	1.12	1.04	1.06	1.05	1.04
425	6.56	6.59	6.57	6.51	0.07	0.98	23.14	31.75	23.32	1.12	1.04	1.06	1.04	1.04
450	6.57	6.61	6.59	6.52	0.09	1.05	22.91	31.59	23.09	1.12	1.03	1.05	1.04	1.03
475	6.58	6.62	6.61	6.53	0.09	1.13	22.73	31.46	22.91	1.12	1.03	1.04	1.03	1.03
500	6.60	6.64	6.63	6.54	0.10	1.21	22.59	31.39	22.77	1.12	1.02	1.04	1.03	1.02
525	6.61	6.65	6.64	6.55	0.10	1.28	22.52	31.38	22.69	1.12	1.02	1.04	1.03	1.02
550	6.61	6.67	6.66	6.55	0.11	1.39	22.44	31.49	22.63	1.12	1.02	1.04	1.03	1.02
575	6.63	6.68	6.67	6.56	0.12	1.47	22.42	31.63	22.60	1.12	1.02	1.04	1.03	1.02
600	6.63	6.70	6.69	6.57	0.13	1.57	22.42	31.85	22.61	1.12	1.03	1.04	1.03	1.03
625	6.65	6.72	6.71	6.58	0.14	1.65	22.44	32.16	22.62	1.12	1.03	1.04	1.04	1.04
650	6.66	6.74	6.73	6.59	0.15	1.76	22.47	32.56	22.66	1.13	1.04	1.05	1.05	1.04
675	6.68	6.76	6.76	6.61	0.15	1.86	22.48	33.15	22.63	1.14	1.05	1.06	1.06	1.05
700	6.69	6.78	6.79	6.62	0.17	1.98	22.42	33.77	22.58	1.16	1.06	1.07	1.07	1.06
725	6.71	6.81	6.82	6.63	0.18	2.12	22.30	34.51	22.47	1.18	1.07	1.08	1.08	1.07
750	6.74	6.84	6.86	6.67	0.19	2.22	22.09	35.02	22.21	1.21	1.08	1.09	1.09	1.08
775	6.77	6.89	6.91	6.70	0.21	2.39	21.69	35.27	21.79	1.25	1.09	1.10	1.10	1.09
800	6.81	6.94	6.97	6.75	0.22	2.51	21.14	34.89	21.23	1.29	1.10	1.12	1.11	1.11
850	6.94	7.10	7.14	6.89	0.25	2.95	19.58	32.17	19.67	1.41	1.13	1.16	1.14	1.14
900	7.14	7.32	7.38	7.11	0.26	3.33	17.68	28.55	17.80	1.58	1.16	1.21	1.18	1.17
950	7.44	7.65	7.72	7.43	0.28	4.03	15.64	25.28	15.89	1.79	1.20	1.27	1.22	1.20
1000	7.90	8.14	8.19	7.90	0.29	5.73	13.73	22.51	14.16	2.06	1.24	1.33	1.26	1.24
1050	8.56	8.83	8.77	8.49	0.35	8.67	11.92	20.31	12.65	2.36	1.30	1.42	1.30	1.27

¹ Total Loss = Insertion Loss+ 6dB Splitter Loss



4 Way-0° Power Splitter/Combiner

SCP-4-1W+

Typical Performance Data

TEST CONDITIONS: INPUT POWER = 0dBm @Temperature = +85°C

FREQ. (MHz)	TOTAL LOSS ¹ (dB)				AMP. UNBAL. (dB)	PHASE UNBAL. (deg.)	ISOLATION (dB)			VSWR (:1)				
	S-1	S-2	S-3	S-4			1-2	2-3	3-4	S	1	2	3	4
10	6.51	6.51	6.51	6.53	0.02	0.08	35.03	40.52	34.29	1.10	1.19	1.19	1.19	1.19
20	6.52	6.52	6.53	6.54	0.02	0.04	35.89	40.10	34.92	1.10	1.17	1.18	1.18	1.18
30	6.52	6.53	6.54	6.55	0.03	0.06	35.27	39.47	34.43	1.09	1.17	1.18	1.18	1.18
40	6.54	6.55	6.55	6.56	0.02	0.09	34.47	38.80	33.87	1.09	1.17	1.18	1.18	1.18
50	6.55	6.56	6.56	6.58	0.03	0.08	33.76	38.19	33.31	1.09	1.17	1.18	1.18	1.18
60	6.56	6.57	6.58	6.59	0.03	0.06	33.05	37.70	32.71	1.09	1.17	1.18	1.18	1.18
70	6.57	6.58	6.59	6.60	0.03	0.07	32.38	37.22	32.16	1.09	1.17	1.18	1.18	1.18
80	6.58	6.59	6.60	6.60	0.03	0.06	31.72	36.82	31.60	1.09	1.17	1.17	1.18	1.18
90	6.59	6.60	6.61	6.61	0.03	0.07	31.14	36.41	31.05	1.09	1.17	1.17	1.17	1.17
100	6.60	6.61	6.61	6.62	0.03	0.05	30.56	36.04	30.54	1.09	1.17	1.17	1.17	1.17
125	6.62	6.63	6.64	6.64	0.02	0.05	29.30	35.26	29.36	1.09	1.17	1.16	1.16	1.17
150	6.64	6.65	6.66	6.66	0.03	0.07	28.22	34.55	28.32	1.08	1.16	1.16	1.16	1.16
175	6.65	6.67	6.68	6.68	0.03	0.05	27.28	33.94	27.42	1.08	1.15	1.16	1.16	1.16
200	6.67	6.69	6.70	6.69	0.03	0.06	26.47	33.39	26.63	1.08	1.15	1.15	1.15	1.15
225	6.69	6.72	6.72	6.71	0.03	0.08	25.75	32.90	25.92	1.07	1.14	1.14	1.14	1.14
250	6.70	6.74	6.74	6.73	0.03	0.09	25.11	32.47	25.28	1.07	1.13	1.14	1.14	1.14
275	6.73	6.77	6.76	6.75	0.04	0.09	24.55	32.09	24.72	1.07	1.12	1.13	1.13	1.13
300	6.75	6.78	6.78	6.77	0.04	0.06	24.04	31.75	24.22	1.07	1.12	1.13	1.12	1.12
325	6.77	6.81	6.81	6.79	0.05	0.04	23.60	31.44	23.78	1.06	1.11	1.12	1.12	1.11
350	6.78	6.83	6.83	6.80	0.05	0.08	23.20	31.19	23.39	1.06	1.10	1.11	1.11	1.10
375	6.80	6.86	6.85	6.82	0.06	0.07	22.87	30.98	23.06	1.06	1.09	1.11	1.10	1.10
400	6.82	6.88	6.88	6.84	0.05	0.08	22.59	30.81	22.78	1.06	1.08	1.10	1.09	1.09
425	6.84	6.91	6.90	6.86	0.06	0.10	22.37	30.70	22.55	1.06	1.08	1.09	1.09	1.08
450	6.86	6.93	6.92	6.87	0.06	0.17	22.19	30.62	22.37	1.07	1.07	1.09	1.08	1.07
475	6.88	6.96	6.96	6.89	0.08	0.19	22.06	30.60	22.25	1.07	1.06	1.08	1.07	1.06
500	6.90	6.98	6.98	6.90	0.09	0.22	21.98	30.64	22.17	1.07	1.05	1.07	1.06	1.06
525	6.91	7.00	7.00	6.92	0.09	0.26	21.97	30.75	22.16	1.08	1.04	1.06	1.06	1.05
550	6.93	7.03	7.02	6.94	0.10	0.29	21.96	30.99	22.17	1.08	1.04	1.06	1.05	1.04
575	6.95	7.05	7.05	6.95	0.10	0.43	22.02	31.28	22.24	1.09	1.03	1.05	1.04	1.04
600	6.97	7.08	7.08	6.96	0.11	0.47	22.13	31.70	22.34	1.10	1.03	1.05	1.04	1.03
625	6.98	7.10	7.11	6.99	0.13	0.51	22.28	32.25	22.48	1.12	1.03	1.05	1.04	1.04
650	7.00	7.13	7.14	7.01	0.14	0.61	22.46	33.00	22.67	1.13	1.03	1.05	1.04	1.04
675	7.02	7.16	7.18	7.03	0.16	0.74	22.63	34.01	22.81	1.15	1.04	1.05	1.05	1.05
700	7.04	7.19	7.21	7.05	0.17	0.85	22.76	35.30	22.93	1.18	1.05	1.06	1.06	1.06
725	7.07	7.23	7.25	7.08	0.18	0.97	22.83	37.12	22.99	1.20	1.06	1.07	1.07	1.07
750	7.12	7.29	7.31	7.12	0.19	1.22	22.79	39.24	22.90	1.24	1.07	1.08	1.08	1.08
775	7.15	7.33	7.36	7.17	0.21	1.36	22.52	41.47	22.61	1.28	1.09	1.10	1.09	1.09
800	7.20	7.40	7.43	7.23	0.23	1.60	22.04	41.24	22.13	1.32	1.10	1.12	1.11	1.11
850	7.36	7.59	7.64	7.41	0.28	2.15	20.44	34.84	20.56	1.43	1.13	1.15	1.14	1.13
900	7.60	7.84	7.92	7.67	0.32	2.92	18.37	29.52	18.58	1.57	1.16	1.20	1.17	1.17
950	7.95	8.22	8.31	8.05	0.36	4.06	16.21	25.75	16.56	1.74	1.19	1.25	1.21	1.20
1000	8.45	8.77	8.83	8.57	0.38	5.80	14.23	22.82	14.79	1.95	1.24	1.31	1.25	1.23
1050	9.17	9.52	9.45	9.21	0.35	8.45	12.40	20.61	13.28	2.17	1.29	1.39	1.28	1.27

¹ Total Loss = Insertion Loss+ 6dB Splitter Loss



4 Way-0° Power Splitter/Combiner

SCP-4-1W+

Typical Performance Curves

Total Loss

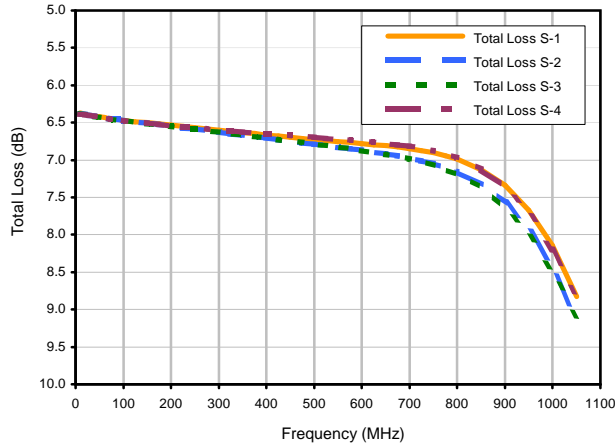

Total Loss S-1 vs. TEMPERATURE

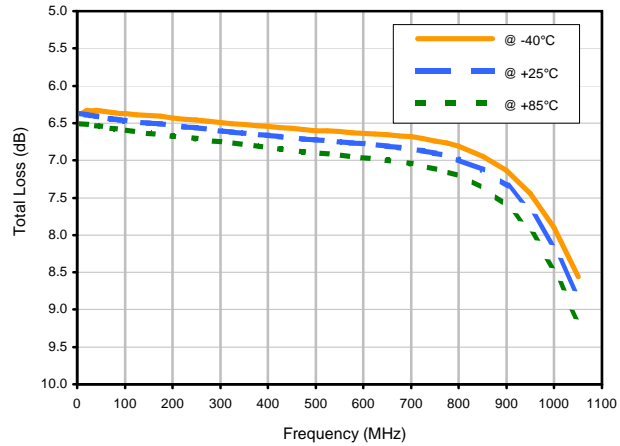

Amplitude Unbalance vs. TEMPERATURE

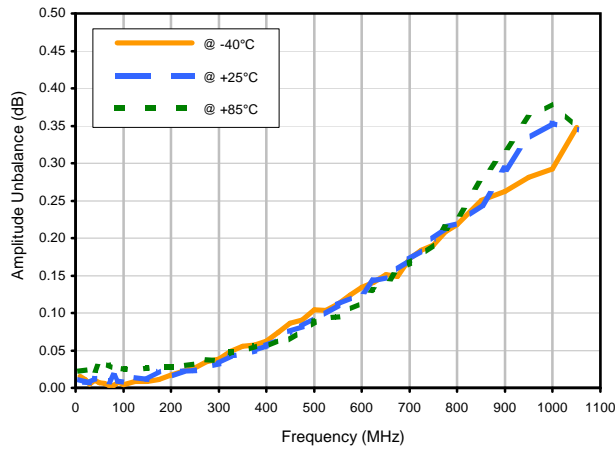

Phase Unbalance vs. TEMPERATURE

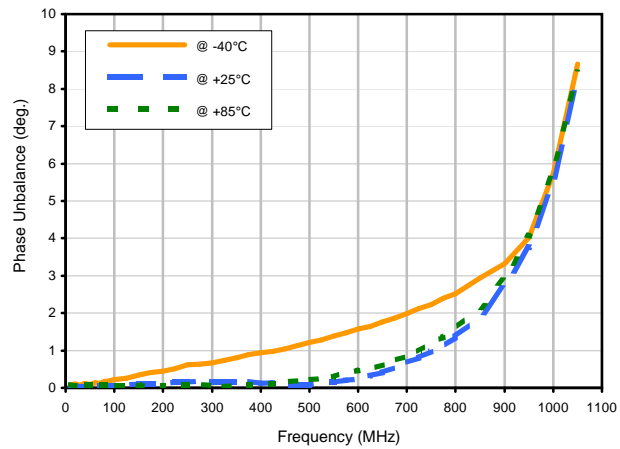

Isolation

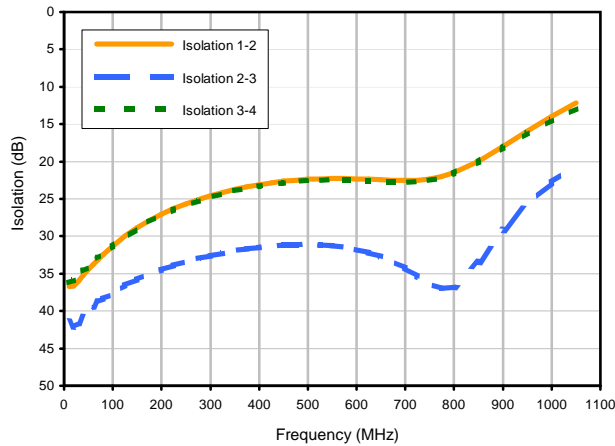

Isolation 1-2 vs. TEMPERATURE

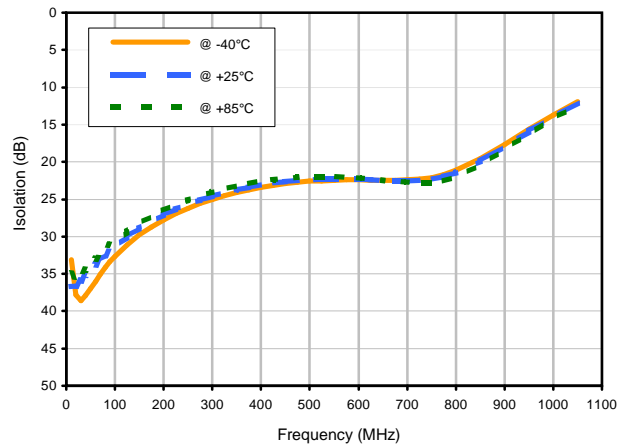

Typical Performance Curves

VSWR

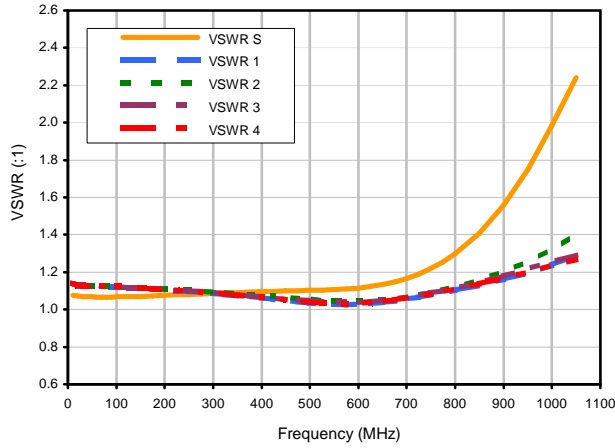

VSWR SUM vs. TEMPERATURE

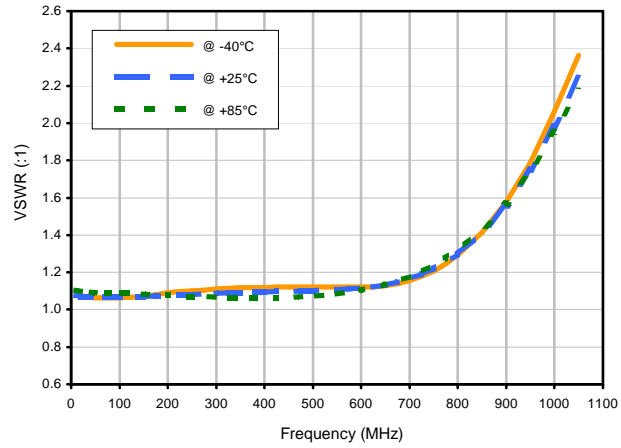

VSWR OUT1 vs. TEMPERATURE

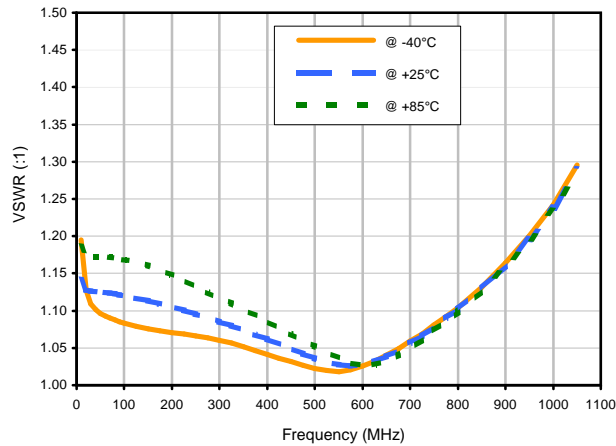

Outline Dimensions

YY101
YY109
YY161

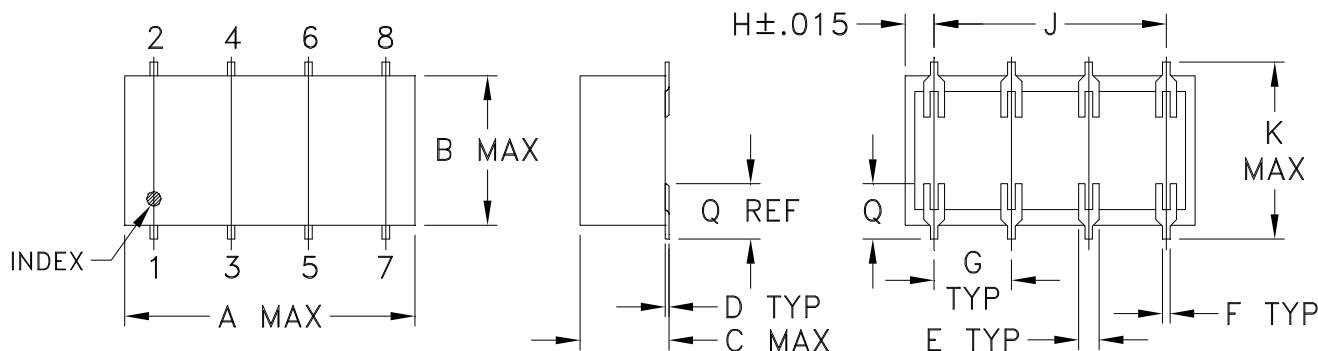

PCB Land Pattern

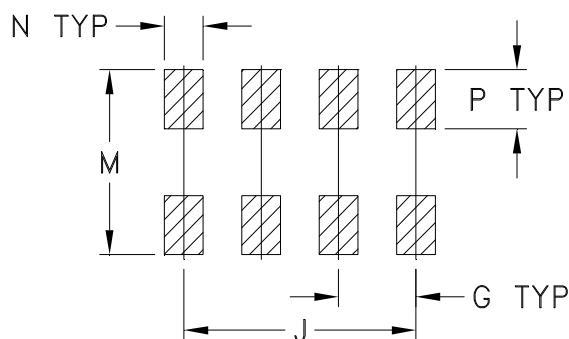

Suggested Layout
Tolerance to be within $\pm .002$

CASE#	A	B	C	D	E	F	G	H	J	K	L	M	N	P	Q	WT. GRAMS
YY101*			.20 (5.08)							.450 (11.43)	-- (11.94)	.470 (11.94)				1.6
YY109*	.75 (19.05)	.38 (9.65)	.20 (5.08)	.010 (0.25)	.050 (1.27)	.020 (0.51)	.200 (5.08)	.075 (1.91)	.600 (15.24)	.720 (18.29)	-- (18.80)	.740 (18.80)	.100 (2.54)	.150 (3.81)	.148 (3.76)	1.6
YY161			.28 (7.11)							.450 (11.43)	-- (11.94)	.470 (11.94)				1.6

Dimensions are in inches (mm). Tolerances: 2 Pl. $\pm .01$; 3 Pl. $\pm .005$

Notes:

- Case material: Plastic.
- Termination finish:
For RoHS Case Styles: Tin plate over Nickel plate.
For RoHS-5 Case Styles: Tin-Lead plate.
- Special Tolerances: Termination thickness $\pm .003$ inch.
- * Denotes: For SCM mixers, long termination version (case YY109) is available upon request, consult factory. To order short termination version (case YY101) add -NL suffix.

Tape & Reel Packaging TR-F5

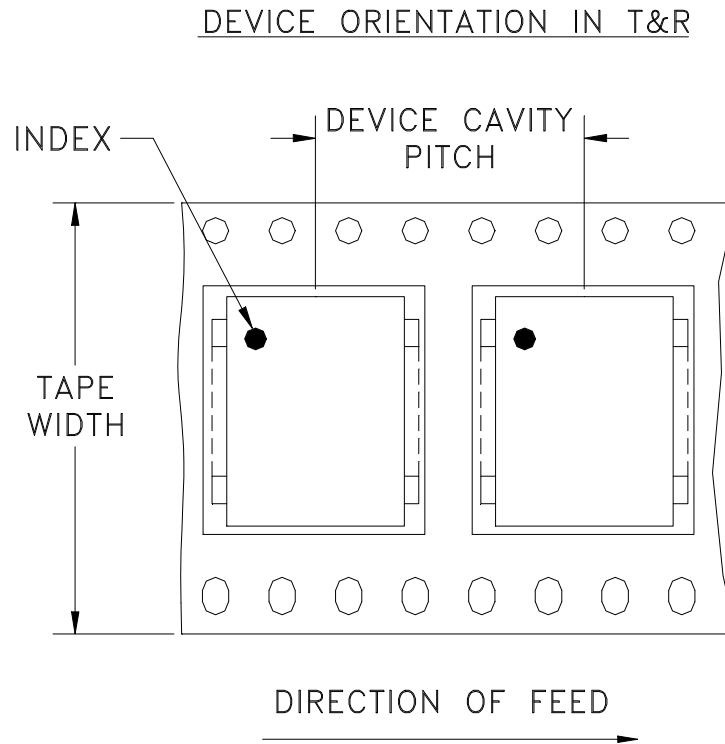

Tape Width, mm	Device Cavity Pitch, mm	Reel Size, inches	Devices per Reel
32	16	13	500

Mini-Circuits carrier tape materials provide protection from ESD (Electro-Static Discharge) during handling and transportation. Tapes are static dissipative and comply with industry standards EIA-481/EIA-541.

Go to: www.minicircuits.com/pages/pdfs/tape.pdf



Distribution Centers NORTH AMERICA 800-654-7949 • 417-335-5935 • Fax 417-335-5945 • EUROPE 44-1252-832600 • Fax 44-1252-837010

Mini-Circuits ISO 9001 & ISO 14001 Certified

INTERNET <http://www.minicircuits.com>

P.O. Box 350166, Brooklyn, New York 11235-0003 (718) 934-4500 Fax (718) 332-4661

THIRD ANGLE PROJECTION

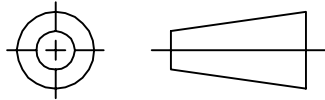

REVISIONS

REV	ECN No.	DESCRIPTION	DATE	DR	AUTH
OR	M82272	NEW RELEASE	08/05/02	MMG	DJ
A	M102713	UPDATED NOTES	01/14/06	GF	IL

**SUGGESTED MOUNTING CONFIGURATION
FOR YY101 CASE STYLE, "bv" PIN CONNECTION**

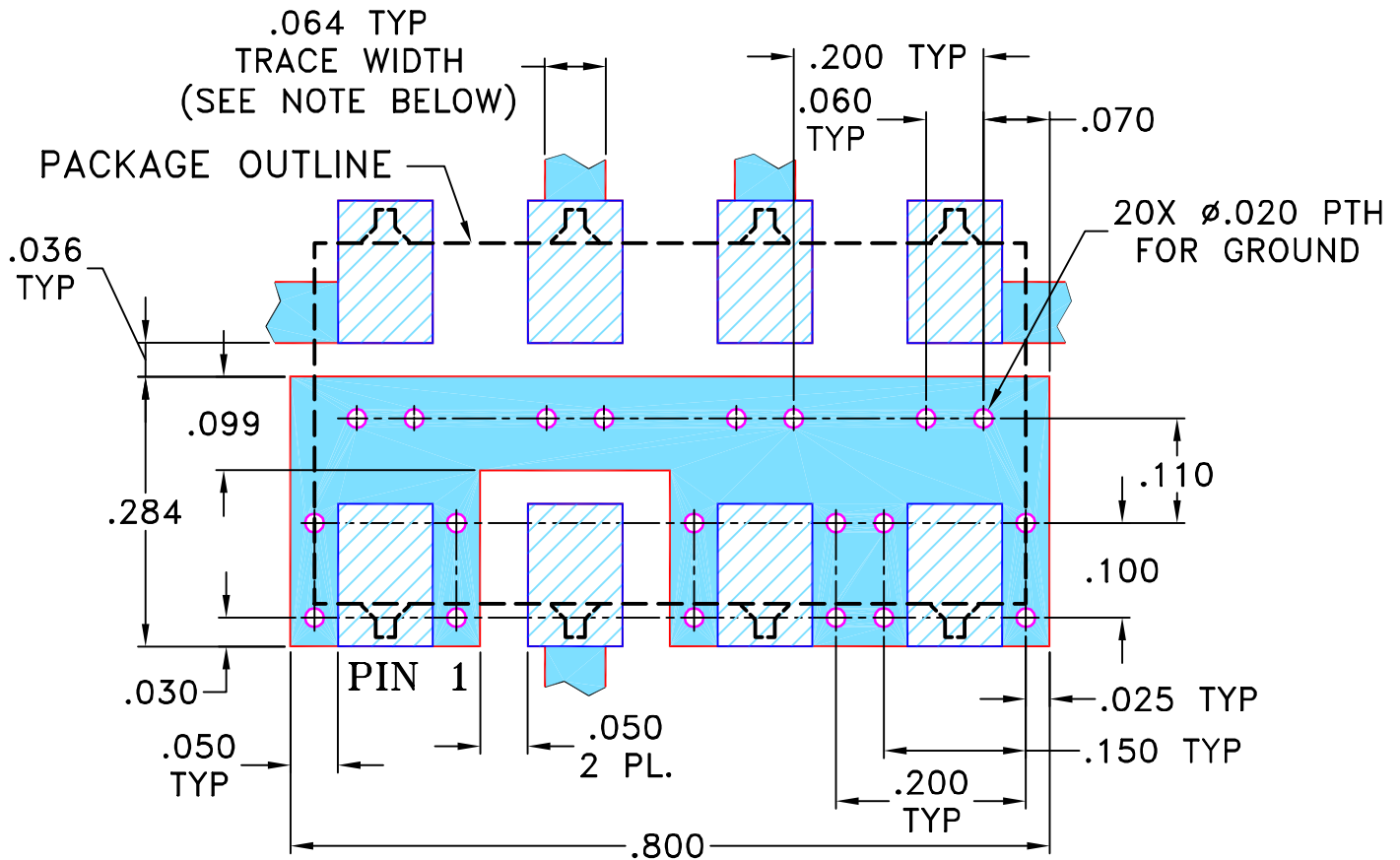

NOTES: 1. TRACE WIDTH IS SHOWN FOR ROGERS RO4350B WITH DIELECTRIC THICKNESS 0.030" ± 0.002"; COPPER: 1/2 OZ. EACH SIDE. FOR OTHER MATERIALS TRACE WIDTH MAY NEED TO BE MODIFIED.
2. BOTTOM SIDE OF THE PCB IS CONTINUOUS GROUND PLANE.

- DENOTES PCB COPPER LAYOUT WITH SMOBC (SOLDER MASK OVER BARE COPPER)
- DENOTES COPPER LAND PATTERN FREE OF SOLDER MASK

UNLESS OTHERWISE SPECIFIED	INITIALS	DATE
DIMENSIONS ARE IN INCHES	DRAWN MMG	07/19/02
TOLERANCES ON:	CHECKED HY	08/01/02
2 PL DECIMALS ±	APPROVED DJ	08/05/02
3 PL DECIMALS ± .005		
ANGLES ±		
FRACTIONS ±		

Mini-Circuits® 13 Neptune Avenue
Brooklyn NY 11235

PL, bv, YY101, SCP-4, TB-36

Mini-Circuits®
 THIS DOCUMENT AND ITS CONTENTS ARE THE PROPERTY OF MINI-CIRCUITS. EXCEPT FOR USE EXPRESSLY GRANTED, IN WRITING, TO ITS VENDORS, VENDEE AND THE UNITED STATES GOVERNMENT, MINI-CIRCUITS RESERVES ALL PROPRIETARY DESIGN, USE, MANUFACTURING AND REPRODUCTION RIGHTS THERETO. THESE CONTENTS SHALL NOT BE USED, DUPLICATED OR DISCLOSED TO ANY OUTSIDE PARTY, IN WHOLE OR IN PART, WITHOUT WRITTEN PERMISSION OF MINI-CIRCUITS.

SIZE A	CODE IDENT 15542	DRAWING NO: 98-PL-073	REV: A
FILE: 98PL073	SCALE: 5:1	SHEET: 1 OF 1	

Evaluation Board and Circuit

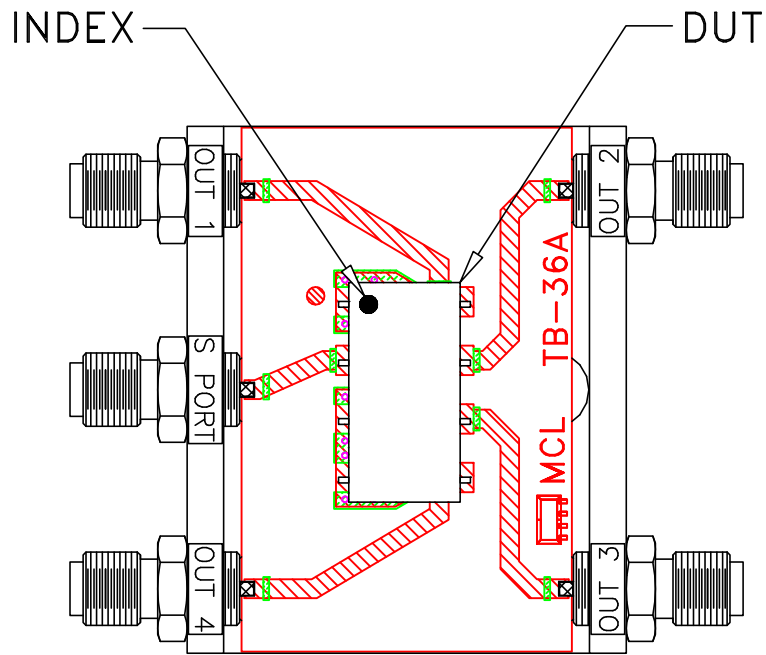

TB-36

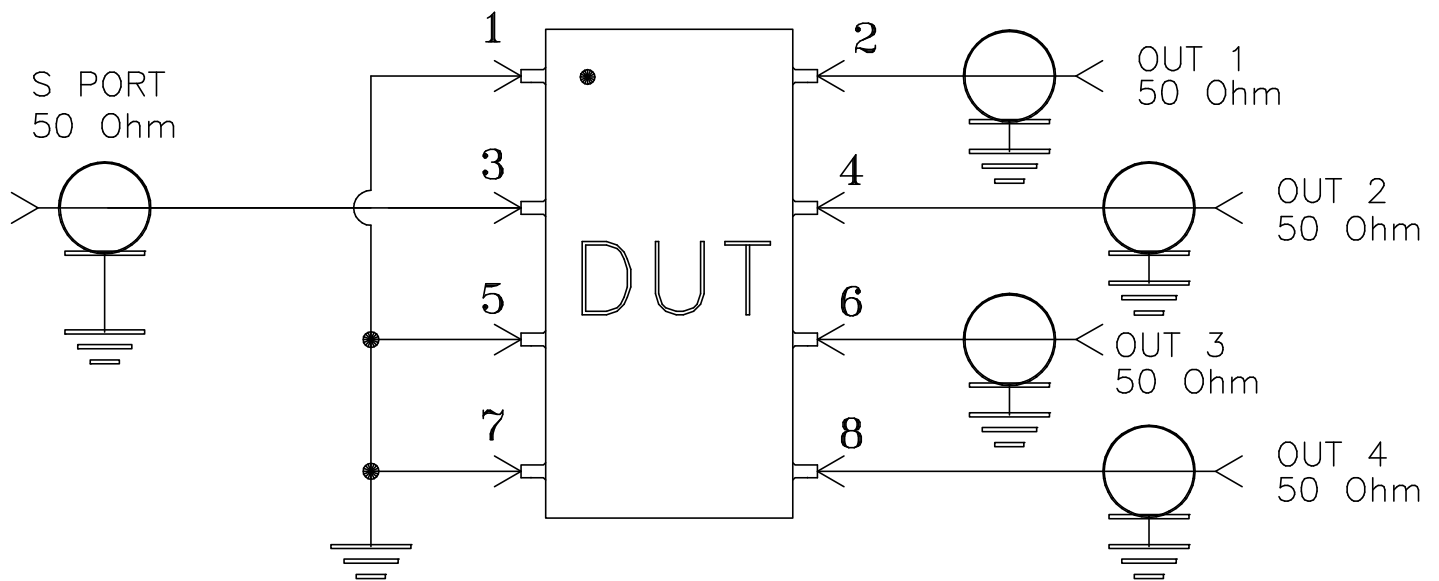

Schematic Diagram

Notes:

1. SMA Female connectors.
2. PCB Material: Rogers R04350 or equivalent, Dielectric Constant=3.5, Thickness=.030 inch.

 **Mini-Circuits®**

All Mini-Circuits products are manufactured under exacting quality assurance and control standards, and are capable of meeting published specifications after being subjected to any or all of the following physical and environmental test.

Specification	Test/Inspection Condition	Reference/Spec
Operating Temperature	-40° to 85°C Ambient Environment	Individual Model Data Sheet
Storage Temperature	-55° to 100° C Ambient Environment	Individual Model Data Sheet
Humidity	90 to 95% RH, 240 hours, 50°C	MIL-STD-202, Method 103, Condition A, Except 50°C and end-point electrical test done within 12 hours
Thermal Shock	-55° to 100°C, 100 cycles	MIL-STD-202, Method 107, Condition A-3, except +100°C
Solder Reflow Heat	Sn-Pb Eutetic Process: 225°C peak Pb-Free Process 245° - 250°C peak	J-STD-020, Table 4-1, 4-2 and 5-2, Figure 5-1
Solderability	10X Magnification	J-STD-002, 95% Coverage
Vibration (High Frequency)	20g peak, 10-2000 Hz, 12 times in each of three perpendicular directions (total 36)	MIL-STD-202, Method 204, Condition D
Mechanical Shock	50g, 11 ms, 1/2-sine, 18 shocks: 3 each direction, each of 3 axes	MIL-STD-202, Method 213, Condition A
Marking Resistance to Solvents	Isopropyl alcohol + mineral spirits at 25°C; terpene defluxer at 25°C; distilled water + proylene glycol monomethyl ether + monoethanolamine at 63°C to 70°C	MIL-STD-202, Method 215