

Surface Mount

Monolithic Amplifier

DC-3 GHz

Features

- Miniature SOT-89 package
- Low noise figure, 2.4 dB typ.
- Internally Matched to 50 Ohms
- Wide bandwidth, DC to 3 GHz
- Excellent package for heat dissipation, exposed metal bottom
- Low thermal resistance for high reliability
- Aqueous washable

Applications

- Cellular
- PCS
- Communication receivers & transmitters

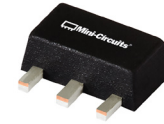

Generic photo used for illustration purposes only

Gali-S66+

CASE STYLE: DF782

+RoHS Compliant

The +Suffix identifies RoHS Compliance. See our web site for RoHS Compliance methodologies and qualifications

General Description

Gali-S66+ (RoHS compliant) is a wideband amplifier offering high dynamic range. Lead finish is SnAgNi. It has repeatable performance from lot to lot, and is enclosed in a SOT-89 package. It uses Darlington configuration and is designed to be rugged for ESD.

simplified schematic and pin description



Function	Pin Number	Description
RF IN	1	RF input pin. This pin requires the use of an external DC blocking capacitor chosen for the frequency of operation.
RF-OUT and DC-IN	3	RF output and bias pin. DC voltage is present on this pin; therefore a DC blocking capacitor is necessary for proper operation. An RF choke is needed to feed DC bias without loss of RF signal due to the bias connection, as shown in "Recommended Application Circuit".
GND	2,4	Connections to ground. Use via holes as shown in "Suggested Layout for PCB Design" to reduce ground path inductance for best performance.

Notes

- A. Performance and quality attributes and conditions not expressly stated in this specification document are intended to be excluded and do not form a part of this specification document.
B. Electrical specifications and performance data contained in this specification document are based on Mini-Circuit's applicable established test performance criteria and measurement instructions.
C. The parts covered by this specification document are subject to Mini-Circuits standard limited warranty and terms and conditions (collectively, "Standard Terms"); Purchasers of this part are entitled to the rights and benefits contained therein. For a full statement of the Standard Terms and the exclusive rights and remedies thereunder, please visit Mini-Circuits' website at www.minicircuits.com/MCLStore/terms.jsp



Electrical Specifications at 25°C and 16mA, unless noted

Parameter		Min.	Typ.	Max.	Units
Frequency Range*		DC		3	GHz
Gain	f=0.1 GHz	—	21.6	—	dB
	f=1 GHz	—	20.3	—	
	f=2 GHz	15	18.2	—	
	f=3 GHz	—	16.4	—	
Input Return Loss	f= DC to 3 GHz		25		dB
Output Return Loss	f= DC to 3 GHz		20		dB
Output Power @ 1 dB compression	f=2 GHz	1.0	3.3	—	dBm
Output IP3	f=2 GHz		19.1		dBm
Noise Figure	f=2 GHz		2.4		dB
Recommended Device Operating Current			16		mA
Device Operating Voltage		3.0	3.5	4.0	V
Device Voltage Variation vs. Temperature at 16 mA			-2.1		mV/°C
Device Voltage Variation vs. Current at 25°C			3.7		mV/mA
Thermal Resistance, junction-to-case ¹			64		°C/W

*Guaranteed specification DC-3 GHz. Low frequency cut off determined by external coupling capacitors.

Absolute Maximum Ratings

Parameter	Ratings
Operating Temperature	-45°C to 85°C
Storage Temperature	-65°C to 150°C
Operating Current	50mA
Input Power	20dBm

Note: Permanent damage may occur if any of these limits are exceeded.

Notes

- A. Performance and quality attributes and conditions not expressly stated in this specification document are intended to be excluded and do not form a part of this specification document.
 B. Electrical specifications and performance data contained in this specification document are based on Mini-Circuit's applicable established test performance criteria and measurement instructions.
 C. The parts covered by this specification document are subject to Mini-Circuits standard limited warranty and terms and conditions (collectively, "Standard Terms"); Purchasers of this part are entitled to the rights and benefits contained therein. For a full statement of the Standard Terms and the exclusive rights and remedies thereunder, please visit Mini-Circuits' website at www.minicircuits.com/MCLStore/terms.jsp



Product Marking

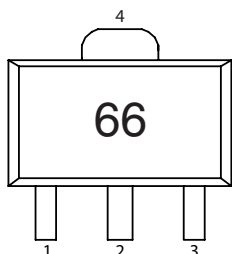

Markings in addition to model number designation may appear for internal quality control purposes.

Additional Detailed Technical Information

Additional information is available on our web site. To access this information enter the model number on our web site home page.

Performance data, graphs, s-parameter data set (.zip file)

Case Style: DF782

Plastic package, exposed paddle, lead finish: Matte-Tin

Tape & Reel: F55

7” reels with 20, 50, 100, 200, 500, 1K devices.

Suggested Layout for PCB Design: PL-019

Evaluation Board: TB-409-S66+

Environmental Ratings: ENV08T2

Recommended Application Circuit

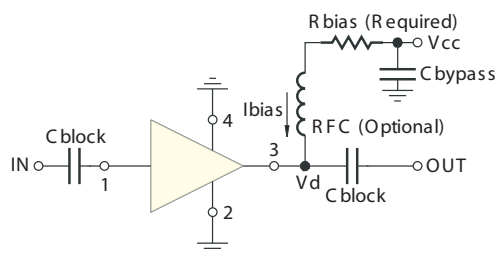

Test Board includes case, connectors, and components (in bold) soldered to PCB

R BIAS	
Vcc	“1%” Res. Values (ohms) for Optimum Biasing
7	187
8	243
9	301
10	374
11	432
12	499
13	562
14	619
15	681
16	750
17	806
18	866
19	931
20	976

Notes

- A. Performance and quality attributes and conditions not expressly stated in this specification document are intended to be excluded and do not form a part of this specification document.
- B. Electrical specifications and performance data contained in this specification document are based on Mini-Circuit's applicable established test performance criteria and measurement instructions.
- C. The parts covered by this specification document are subject to Mini-Circuits standard limited warranty and terms and conditions (collectively, "Standard Terms"); Purchasers of this part are entitled to the rights and benefits contained therein. For a full statement of the Standard Terms and the exclusive rights and remedies thereunder, please visit Mini-Circuits' website at www.minicircuits.com/MCLStore/terms.jsp



ESD Rating

Human Body Model (HBM): Class 1C (1000v to < 2000v) in accordance with ANSI/ESD STM 5.1 - 2001

Machine Model (MM): Class M2 (100V) in accordance with ANSI/ESD STM 5.2 - 1999

MSL Rating

Moisture Sensitivity: MSL1 in accordance with IPC/JEDECJ-STD-020C

No.	Test Required	Condition	Standard	Quantity
1	Visual Inspection	Low Power Microscope Magnification 40x	MIP-IN-0003 (MCT spec)	45 units
2	Electrical Test	Room Temperature	SCD (MCL spec)	45 units
3	SAM Analysis	Less than 10% growth in term of delamination	J-Std-020C (Jedec Standard)	45 units
4	Moisture Sensitivity Level 1	Bake at 125°C for 24 hours Soak at 85°C/85%RH for 168 hours Reflow 3 cycles at 260°C peak	J-Std-020C (Jedec Standard)	45 units

MSL Test Flow Chart

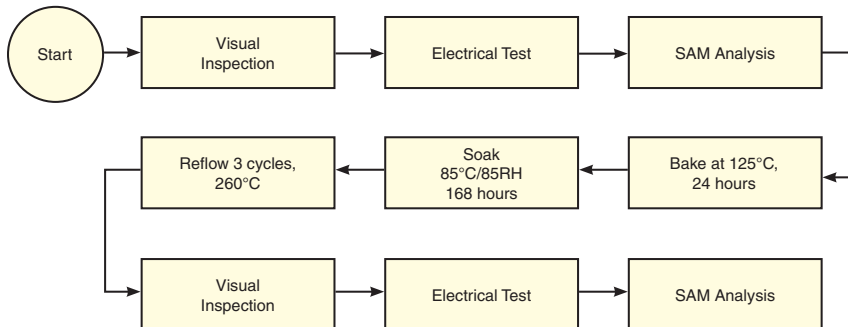

Notes

- A. Performance and quality attributes and conditions not expressly stated in this specification document are intended to be excluded and do not form a part of this specification document.
- B. Electrical specifications and performance data contained in this specification document are based on Mini-Circuit's applicable established test performance criteria and measurement instructions.
- C. The parts covered by this specification document are subject to Mini-Circuits standard limited warranty and terms and conditions (collectively, "Standard Terms"); Purchasers of this part are entitled to the rights and benefits contained therein. For a full statement of the Standard Terms and the exclusive rights and remedies thereunder, please visit Mini-Circuits' website at www.minicircuits.com/MCLStore/terms.jsp



Typical Performance Data

**NOTE: Use PDF Bookmarks to view DATA at required conditions
or to view GRAPHS.**

Definitions:

Input Return Loss = -S11 (dB)

Gain(Power Gain) = S21 (dB)

Reverse Isolation = -S12 (dB)

Output Return Loss = -S22 (dB)

TEST CONDITIONS: Icc = 16mA, Vd = 3.49V @Temperature = +25degC

FREQ	Gain	Isolation	Input Return Loss	Output Return Loss	Stability		FREQ	IP3 Output	1dB Comp. Output	Noise Figure
(MHz)	(dB)	(dB)	(dB)	(dB)	K	Delta	(MHz)	(dBm)	(dBm)	(dB)
50	21.88	24.76	34.31	50.41	1.06	0.72	50	18.85	3.44	2.05
100	22.30	24.54	33.71	30.10	1.03	0.77	100	18.65	3.71	2.26
200	21.93	24.54	32.51	27.52	1.04	0.74	150	19.48	3.63	2.14
400	21.62	24.66	30.01	21.61	1.05	0.70	200	18.28	3.46	1.99
600	21.48	24.40	25.93	18.24	1.04	0.71	250	17.52	3.40	2.13
800	21.10	24.52	23.56	16.03	1.05	0.67	300	18.23	3.02	2.43
1000	20.58	24.11	21.69	14.57	1.04	0.65	350	18.25	3.69	2.16
1200	19.84	24.06	20.21	13.61	1.06	0.60	400	17.42	2.60	2.19
1400	19.45	23.63	18.43	12.86	1.04	0.59	450	17.49	3.32	2.14
1600	18.93	23.60	17.43	12.32	1.06	0.56	500	17.00	3.54	2.26
1800	18.46	23.08	16.31	11.86	1.04	0.56	550	16.91	3.39	2.33
2000	17.85	22.88	16.14	11.56	1.06	0.53	600	16.83	2.79	2.19
2200	17.34	22.66	15.26	11.50	1.06	0.50	650	17.04	2.96	2.17
2400	17.03	22.24	14.45	11.35	1.04	0.51	700	16.84	2.68	2.20
2600	16.54	21.91	14.56	11.42	1.06	0.50	750	16.82	3.36	2.23
2800	16.13	21.77	14.01	11.42	1.07	0.48	800	17.15	3.20	2.25
3000	15.92	21.41	13.31	11.41	1.05	0.48	850	16.46	2.90	2.17
3200	15.61	21.38	12.97	11.65	1.07	0.46	900	16.74	3.38	2.25
3400	15.35	20.96	12.44	11.67	1.05	0.47	950	16.79	2.79	2.32
3600	15.07	20.71	12.60	11.78	1.06	0.47	1000	17.02	2.96	2.21
3800	14.88	20.65	12.26	11.95	1.06	0.46	1100	16.57	2.87	2.18
4000	14.62	20.26	12.32	11.94	1.05	0.47	1200	16.86	2.45	2.26
4200	14.43	20.12	11.95	11.89	1.05	0.47	1300	16.75	2.32	2.21
4400	14.32	19.85	11.71	11.75	1.04	0.48	1400	16.73	2.83	2.36
4600	14.09	19.74	11.76	11.47	1.05	0.48	1500	16.70	2.71	2.36
4800	14.01	19.44	11.45	10.99	1.02	0.50	1600	16.98	2.52	2.37
5000	13.82	19.37	11.30	10.51	1.03	0.50	1700	17.39	2.58	2.24
5500	13.50	19.21	10.62	8.69	1.02	0.53	1800	17.09	2.53	2.41
6000	12.92	19.03	8.93	6.89	0.98	0.55	1900	16.99	2.51	2.23
6500	12.02	19.22	7.26	5.53	0.98	0.57	2000	16.81	2.58	2.24
7000	10.74	19.89	5.93	4.50	1.03	0.58	2100	16.73	2.25	2.29
7500	8.95	20.33	5.14	4.15	1.16	0.56	2200	17.40	2.46	2.24
8000	7.08	20.20	4.77	4.05	1.31	0.55	2300	17.66	2.62	2.29
9000	3.43	18.75	4.34	4.02	1.52	0.54	2400	18.11	2.70	2.32
10000	0.84	15.80	4.19	4.20	1.46	0.53	2500	17.32	2.93	2.25
11000	-0.38	12.28	4.71	4.89	1.30	0.52	2600	17.14	2.84	2.32
12000	-0.76	9.06	5.37	6.11	1.16	0.53	2700	17.08	2.95	2.30
13000	-1.03	6.02	6.24	7.57	1.07	0.60	2800	16.98	2.77	2.28
14000	-2.53	5.17	4.98	5.46	1.04	0.68	2900	16.74	2.90	2.28
15000	-5.14	6.35	3.50	3.55	1.09	0.68	3000	17.29	2.88	2.11

REV. X1

GALI-S66+

120123

Page 1 of 11



IF/RF MICROWAVE COMPONENTS • ISO 9001 ISO 14001 AS 9100 CERTIFIED • RoHS compliant

P.O. Box 350166, Brooklyn, New York 11235-0003 (718) 934-4500 Fax (718) 332-4661



The Design Engineers Search Engine finds the model you need, Instantly • For detailed performance specs & shopping online see



Typical Performance Data

Definitions:

Input Return Loss = -S11 (dB)

Gain(Power Gain) = S21 (dB)

Reverse Isolation = -S12 (dB)

Output Return Loss = -S22 (dB)

TEST CONDITIONS: Icc = 13mA, Vd = 3.47V @Temperature = +25degC

FREQ	Gain	Isolation	Input Return Loss	Output Return Loss	Stability		FREQ	IP3 Output	1dB Comp. Output	Noise Figure
					K	Delta				
(MHz)	(dB)	(dB)	(dB)	(dB)	K	Delta	(MHz)	(dBm)	(dBm)	(dB)
50	20.43	23.35	17.05	16.46	1.05	0.74	50	17.08	0.44	2.12
100	20.33	23.54	18.73	16.33	1.06	0.71	100	16.50	0.30	2.20
200	20.10	23.38	18.77	16.27	1.06	0.70	150	17.02	0.20	2.19
400	20.26	23.25	17.26	16.36	1.04	0.72	200	15.68	0.03	2.19
600	19.76	23.33	16.52	15.87	1.05	0.66	250	15.40	0.89	2.23
800	19.78	22.98	16.26	14.37	1.02	0.68	300	15.68	0.34	2.35
1000	19.01	23.10	16.12	13.30	1.04	0.61	350	16.25	0.66	2.21
1200	18.75	22.63	15.18	12.73	1.01	0.61	400	15.29	0.37	2.35
1400	18.16	22.57	13.78	12.50	1.01	0.56	450	15.39	0.97	2.24
1600	17.97	22.05	13.73	11.95	0.98	0.58	500	14.78	0.03	2.20
1800	17.29	22.04	13.35	11.53	1.00	0.52	550	14.39	0.21	2.33
2000	16.92	21.67	13.18	11.16	0.99	0.52	600	14.33	0.08	2.34
2200	16.57	21.36	12.25	11.14	0.97	0.51	650	14.58	0.09	2.28
2400	16.07	21.33	11.60	11.06	0.99	0.47	700	14.22	0.81	2.18
2600	15.62	21.13	11.76	10.89	1.00	0.46	750	14.14	0.36	2.26
2800	15.49	20.74	11.02	10.96	0.97	0.47	800	14.14	0.07	2.40
3000	15.10	20.62	10.46	11.02	0.97	0.45	850	14.02	0.11	2.29
3200	15.00	20.20	10.54	11.16	0.96	0.47	900	14.21	0.24	2.23
3400	14.61	20.15	10.41	11.14	0.97	0.45	950	13.63	0.71	2.34
3600	14.46	19.76	10.45	11.12	0.96	0.46	1000	13.95	0.57	2.31
3800	14.32	19.59	9.99	11.49	0.95	0.46	1100	14.18	1.16	2.18
4000	14.04	19.50	10.16	11.42	0.97	0.45	1200	14.14	0.87	2.37
4200	13.99	19.10	9.71	11.62	0.94	0.47	1300	14.19	0.41	2.21
4400	13.79	19.10	9.68	11.61	0.96	0.46	1400	13.67	0.82	2.44
4600	13.71	18.75	9.55	11.41	0.93	0.48	1500	14.01	1.05	2.38
4800	13.55	18.69	9.66	11.09	0.94	0.48	1600	14.26	0.95	2.44
5000	13.53	18.39	9.28	10.67	0.91	0.50	1700	14.28	0.70	2.29
5500	13.22	18.13	9.28	9.28	0.91	0.52	1800	14.16	0.86	2.46
6000	12.66	18.12	8.01	7.36	0.89	0.54	1900	14.01	0.70	2.31
6500	11.80	18.39	6.56	5.81	0.87	0.55	2000	14.22	0.87	2.26
7000	10.57	18.68	5.60	4.82	0.90	0.56	2100	13.72	1.02	2.38
7500	8.80	19.45	4.95	4.53	1.06	0.54	2200	14.22	0.31	2.24
8000	6.95	19.56	4.69	4.35	1.22	0.53	2300	14.98	0.31	2.39
9000	3.25	18.73	4.35	4.40	1.56	0.50	2400	15.52	0.15	2.28
10000	0.63	15.95	4.23	4.48	1.52	0.50	2500	14.88	0.32	2.34
11000	-0.61	12.46	4.70	5.09	1.33	0.49	2600	14.64	0.42	2.31
12000	-0.95	9.31	5.28	6.33	1.18	0.50	2700	14.42	0.18	2.38
13000	-1.23	6.12	6.08	7.66	1.07	0.58	2800	14.44	0.49	2.24
14000	-2.65	5.20	4.91	5.50	1.04	0.67	2900	14.42	0.51	2.37
15000	-5.24	6.37	3.47	3.57	1.09	0.68	3000	14.81	0.71	2.05

REV. X1

GALI-S66+

120123

Page 2 of 11



IF/RF MICROWAVE COMPONENTS • ISO 9001 ISO 14001 AS 9100 CERTIFIED RoHS compliant

P.O. Box 350166, Brooklyn, New York 11235-0003 (718) 934-4500 Fax (718) 332-4661



The Design Engineers Search Engine finds the model you need, Instantly • For detailed performance specs & shopping online see



Typical Performance Data

Definitions:

Input Return Loss = -S11 (dB)

Gain(Power Gain) = S21 (dB)

Reverse Isolation = -S12 (dB)

Output Return Loss = -S22 (dB)

TEST CONDITIONS: Icc = 19mA, Vd = 3.51V @Temperature = +25degC

FREQ	Gain	Isolation	Input Return Loss	Output Return Loss	Stability		FREQ	IP3 Output	1dB Comp. Output	Noise Figure
					K	Delta				
(MHz)	(dB)	(dB)	(dB)	(dB)	K	Delta	(MHz)	(dBm)	(dBm)	(dB)
50	23.27	25.98	20.41	19.32	1.05	0.74	50	20.66	6.21	2.02
100	23.06	25.40	18.99	17.25	1.03	0.78	100	20.28	5.99	2.34
200	23.10	25.56	18.36	19.09	1.04	0.77	150	21.08	5.93	2.12
400	22.86	25.58	20.20	17.86	1.04	0.74	200	20.06	5.85	1.92
600	22.23	25.36	19.73	15.54	1.05	0.71	250	19.59	5.74	2.09
800	21.73	25.41	21.03	14.33	1.06	0.66	300	20.00	5.42	2.46
1000	21.16	25.02	20.36	13.21	1.06	0.65	350	20.35	6.10	2.16
1200	20.72	24.84	20.27	12.76	1.07	0.62	400	19.33	5.58	2.08
1400	20.02	24.42	19.47	12.04	1.07	0.60	450	19.27	5.65	2.08
1600	19.42	24.31	18.83	11.83	1.09	0.57	500	19.26	5.75	2.30
1800	18.86	23.84	18.13	11.43	1.09	0.56	550	18.85	5.62	2.32
2000	18.43	23.56	17.70	11.30	1.09	0.55	600	19.05	5.62	2.09
2200	17.90	23.31	17.06	11.29	1.10	0.52	650	19.22	5.79	2.13
2400	17.42	22.82	16.59	11.16	1.09	0.52	700	18.97	5.64	2.24
2600	17.06	22.53	16.34	11.28	1.10	0.52	750	19.03	5.64	2.28
2800	16.67	22.31	15.51	11.34	1.10	0.50	800	19.27	5.66	2.18
3000	16.26	21.92	15.00	11.34	1.09	0.50	850	18.83	5.48	2.10
3200	15.95	21.74	14.77	11.67	1.10	0.48	900	19.27	5.82	2.27
3400	15.61	21.41	14.60	11.64	1.10	0.49	950	18.89	4.99	2.35
3600	15.43	21.13	14.32	11.78	1.09	0.49	1000	19.28	5.25	2.13
3800	15.10	21.02	13.89	11.93	1.11	0.48	1100	19.23	4.87	2.19
4000	14.96	20.71	14.06	11.87	1.10	0.49	1200	19.32	4.72	2.20
4200	14.73	20.54	13.51	11.82	1.10	0.48	1300	19.23	5.05	2.20
4400	14.55	20.23	13.64	11.55	1.09	0.50	1400	19.12	5.02	2.31
4600	14.40	20.12	13.18	11.27	1.09	0.50	1500	19.07	4.83	2.35
4800	14.18	19.90	13.09	10.70	1.08	0.51	1600	19.32	4.91	2.37
5000	14.10	19.78	12.40	10.18	1.07	0.51	1700	19.78	4.90	2.20
5500	13.68	19.64	11.34	8.46	1.06	0.53	1800	19.58	4.88	2.38
6000	13.09	19.56	9.47	6.66	1.04	0.56	1900	19.47	4.86	2.20
6500	12.11	19.80	7.53	5.23	1.03	0.57	2000	19.34	4.69	2.23
7000	10.82	20.39	6.07	4.31	1.09	0.58	2100	18.89	4.84	2.27
7500	9.08	20.67	5.20	3.96	1.20	0.58	2200	19.63	5.12	2.26
8000	7.21	20.38	4.82	3.86	1.32	0.57	2300	19.96	5.30	2.26
9000	3.53	18.77	4.31	3.85	1.51	0.55	2400	19.95	5.33	2.31
10000	0.91	15.70	4.16	4.00	1.44	0.55	2500	19.35	5.37	2.21
11000	-0.28	12.17	4.67	4.69	1.28	0.54	2600	19.17	5.44	2.35
12000	-0.63	8.94	5.37	5.97	1.15	0.55	2700	19.01	5.34	2.28
13000	-0.93	5.94	6.31	7.44	1.06	0.61	2800	18.96	5.26	2.31
14000	-2.47	5.13	5.01	5.43	1.04	0.68	2900	18.64	5.23	2.27
15000	-5.06	6.36	3.51	3.55	1.09	0.69	3000	18.97	5.10	2.15

REV. X1

GALI-S66+

120123

Page 3 of 11



IF/RF MICROWAVE COMPONENTS • ISO 9001 ISO 14001 AS 9100 CERTIFIED • RoHS compliant

P.O. Box 350166, Brooklyn, New York 11235-0003 (718) 934-4500 Fax (718) 332-4661



The Design Engineers Search Engine finds the model you need, Instantly • For detailed performance specs & shopping online see



Typical Performance Data

Definitions:

Input Return Loss = -S11 (dB)

Gain(Power Gain) = S21 (dB)

Reverse Isolation = -S12 (dB)

Output Return Loss = -S22 (dB)

TEST CONDITIONS: Icc = 16mA, Vd = 3.81V @Temperature = -45degC

FREQ	Gain	Isolation	Input Return Loss	Output Return Loss	Stability		FREQ	IP3 Output	1dB Comp. Output	Noise Figure
					K	Delta				
(MHz)	(dB)	(dB)	(dB)	(dB)	K	Delta	(MHz)	(dBm)	(dBm)	(dB)
50	22.94	25.66	21.37	19.53	1.05	0.74	50	17.81	3.77	1.71
100	23.23	25.45	22.45	22.39	1.03	0.78	100	17.32	2.77	1.96
200	23.04	25.46	22.54	19.53	1.04	0.76	150	17.66	3.07	1.78
400	22.60	25.58	21.13	17.05	1.05	0.72	200	17.04	3.26	1.61
600	22.21	25.44	22.55	16.48	1.05	0.69	250	16.88	2.91	1.73
800	21.85	25.29	21.77	15.12	1.05	0.68	300	17.08	2.84	2.13
1000	21.45	24.86	20.82	14.28	1.04	0.68	350	17.42	3.86	1.83
1200	20.84	24.76	19.48	13.07	1.06	0.64	400	16.44	3.49	1.76
1400	20.13	24.59	18.86	12.51	1.07	0.59	450	16.52	2.98	1.75
1600	19.69	24.16	18.26	12.06	1.06	0.59	500	16.43	2.97	1.90
1800	19.24	23.73	17.29	11.77	1.05	0.58	550	16.01	2.68	1.95
2000	18.79	23.32	17.09	11.38	1.05	0.58	600	16.35	2.90	1.76
2200	18.14	23.20	16.48	11.23	1.07	0.55	650	16.29	2.89	1.75
2400	17.74	22.83	15.62	11.23	1.06	0.54	700	16.44	3.02	1.84
2600	17.39	22.47	15.74	11.27	1.07	0.54	750	15.95	2.73	1.88
2800	16.92	22.26	15.12	11.38	1.08	0.52	800	16.75	3.07	1.82
3000	16.57	21.93	14.28	11.61	1.07	0.51	850	16.03	2.85	1.75
3200	16.34	21.64	13.84	11.93	1.07	0.51	900	16.39	2.98	1.87
3400	16.06	21.31	13.37	11.85	1.05	0.51	950	16.16	3.10	1.97
3600	15.85	20.95	13.61	11.76	1.05	0.53	1000	16.46	2.79	1.77
3800	15.51	20.92	13.16	12.02	1.07	0.50	1100	16.49	2.41	1.78
4000	15.36	20.54	13.33	12.01	1.06	0.52	1200	16.40	2.10	1.82
4200	15.08	20.41	12.71	11.87	1.06	0.52	1300	16.60	2.13	1.79
4400	14.98	20.18	12.43	11.80	1.05	0.52	1400	16.23	2.48	1.91
4600	14.79	20.02	12.13	11.30	1.05	0.53	1500	16.16	2.21	1.92
4800	14.71	19.77	11.90	10.98	1.03	0.54	1600	16.42	2.05	1.95
5000	14.57	19.70	11.71	10.32	1.03	0.55	1700	16.74	2.33	1.80
5500	14.42	19.27	10.92	8.71	0.99	0.59	1800	16.71	2.11	1.98
6000	13.85	19.20	8.63	6.55	0.96	0.63	1900	16.66	2.11	1.75
6500	12.83	19.65	6.54	5.08	0.96	0.64	2000	16.42	2.19	1.83
7000	11.48	19.92	5.31	4.24	0.99	0.65	2100	16.16	2.19	1.80
7500	9.67	20.10	4.72	3.96	1.09	0.63	2200	17.05	2.60	1.82
8000	7.92	19.49	4.48	3.91	1.15	0.61	2300	17.48	2.29	1.82
9000	4.29	17.96	3.92	3.68	1.27	0.60	2400	17.77	2.31	1.85
10000	1.48	15.54	3.61	3.70	1.24	0.60	2500	17.50	2.57	1.78
11000	0.28	12.18	4.25	4.51	1.16	0.57	2600	17.39	2.79	1.88
12000	-0.10	8.90	4.92	5.57	1.07	0.60	2700	17.37	2.85	1.83
13000	-0.68	6.09	5.29	6.40	1.00	0.66	2800	17.49	2.74	1.82
14000	-1.85	4.75	4.79	5.53	0.98	0.73	2900	17.11	2.59	1.82
15000	-4.73	6.24	3.02	3.08	1.02	0.75	3000	17.27	2.73	1.66

REV. X1

GALI-S66+

120123

Page 4 of 11



IF/RF MICROWAVE COMPONENTS • ISO 9001 ISO 14001 AS 9100 CERTIFIED • RoHS compliant

P.O. Box 350166, Brooklyn, New York 11235-0003 (718) 934-4500 Fax (718) 332-4661



The Design Engineers Search Engine finds the model you need, Instantly • For detailed performance specs & shopping online see



Typical Performance Data

Definitions:

Input Return Loss = -S11 (dB)

Gain(Power Gain) = S21 (dB)

Reverse Isolation = -S12 (dB)

Output Return Loss = -S22 (dB)

TEST CONDITIONS: Icc = 13mA, Vd = 3.80V @Temperature = -45degC

FREQ	Gain	Isolation	Input Return Loss	Output Return Loss	Stability		FREQ	IP3 Output	1dB Comp. Output	Noise Figure
					K	Delta				
(MHz)	(dB)	(dB)	(dB)	(dB)	K	Delta	(MHz)	(dBm)	(dBm)	(dB)
50	21.17	24.43	22.68	21.54	1.07	0.69	50	16.40	0.44	1.75
100	21.61	23.94	23.96	24.63	1.03	0.77	100	15.31	0.38	1.87
200	21.46	24.18	22.76	24.72	1.05	0.73	150	15.81	0.36	1.81
400	21.04	24.25	22.46	19.72	1.06	0.69	200	14.77	0.51	1.78
600	20.69	23.93	19.54	18.25	1.04	0.68	250	14.73	0.46	1.80
800	20.45	23.80	19.61	15.41	1.03	0.67	300	14.76	0.61	2.03
1000	20.19	23.39	19.11	14.75	1.02	0.67	350	15.20	0.35	1.84
1200	19.67	23.44	18.09	13.74	1.03	0.62	400	14.69	0.23	1.92
1400	18.93	23.04	15.90	13.01	1.02	0.59	450	14.35	0.01	1.82
1600	18.67	23.06	15.25	12.37	1.02	0.56	500	14.14	0.17	1.84
1800	18.32	22.57	14.23	12.01	0.99	0.57	550	13.71	0.07	1.96
2000	17.99	22.53	14.48	11.66	1.01	0.55	600	13.27	0.60	1.90
2200	17.33	22.38	13.56	11.37	1.02	0.50	650	13.90	0.02	1.84
2400	16.95	21.84	12.66	11.27	0.99	0.51	700	13.49	0.14	1.78
2600	16.68	21.67	13.02	11.31	1.01	0.51	750	13.35	0.09	1.86
2800	16.23	21.50	12.28	11.22	1.01	0.48	800	13.57	0.15	1.94
3000	15.86	21.03	11.47	11.43	0.99	0.48	850	12.97	0.18	1.84
3200	15.71	21.02	11.31	11.62	1.00	0.47	900	13.57	0.31	1.83
3400	15.49	20.57	10.98	11.71	0.98	0.49	950	13.07	0.14	1.93
3600	15.36	20.42	11.19	11.58	0.98	0.49	1000	13.48	0.38	1.87
3800	14.99	20.25	10.82	11.69	0.99	0.48	1100	13.28	0.52	1.74
4000	14.93	20.03	10.94	11.96	0.99	0.49	1200	13.44	0.84	1.90
4200	14.65	19.89	10.38	11.86	0.98	0.48	1300	13.64	0.88	1.79
4400	14.57	19.56	10.03	11.92	0.96	0.50	1400	13.27	1.26	2.00
4600	14.40	19.49	9.90	11.61	0.97	0.50	1500	13.20	1.39	1.95
4800	14.36	19.15	9.87	11.26	0.95	0.52	1600	13.44	1.88	1.99
5000	14.24	19.11	9.63	10.77	0.94	0.52	1700	13.61	1.35	1.83
5500	14.18	18.71	9.57	9.23	0.92	0.57	1800	13.24	0.89	2.00
6000	13.66	18.61	7.74	6.90	0.88	0.61	1900	13.20	1.06	1.82
6500	12.66	18.72	5.93	5.38	0.85	0.62	2000	13.35	1.01	1.85
7000	11.31	19.33	4.94	4.62	0.90	0.62	2100	12.99	1.46	1.87
7500	9.52	19.70	4.53	4.32	1.03	0.60	2200	13.65	1.17	1.82
8000	7.79	19.31	4.35	4.29	1.12	0.58	2300	13.88	0.93	1.88
9000	4.13	18.02	3.92	3.97	1.29	0.57	2400	14.68	0.84	1.85
10000	1.36	15.74	3.64	3.95	1.27	0.57	2500	14.42	0.54	1.85
11000	0.10	12.41	4.23	4.76	1.18	0.53	2600	14.26	0.75	1.83
12000	-0.29	9.09	4.87	5.84	1.08	0.56	2700	14.24	0.59	1.91
13000	-0.87	6.20	5.18	6.54	1.00	0.64	2800	14.19	0.40	1.78
14000	-1.94	4.75	4.73	5.59	0.98	0.72	2900	14.07	0.41	1.87
15000	-4.81	6.22	2.99	3.09	1.02	0.75	3000	14.30	0.58	1.62

REV. X1

GALI-S66+

120123

Page 5 of 11



IF/RF MICROWAVE COMPONENTS • ISO 9001 ISO 14001 AS 9100 CERTIFIED • RoHS compliant

P.O. Box 350166, Brooklyn, New York 11235-0003 (718) 934-4500 Fax (718) 332-4661



The Design Engineers Search Engine finds the model you need, Instantly • For detailed performance specs & shopping online see



Typical Performance Data

Definitions:

Input Return Loss = -S11 (dB)

Gain(Power Gain) = S21 (dB)

Reverse Isolation = -S12 (dB)

Output Return Loss = -S22 (dB)

TEST CONDITIONS: Icc = 19mA, Vd = 3.82V @Temperature = -45degC

FREQ	Gain	Isolation	Input Return Loss	Output Return Loss	Stability		FREQ	IP3 Output	1dB Comp. Output	Noise Figure
					K	Delta				
(MHz)	(dB)	(dB)	(dB)	(dB)	K	Delta	(MHz)	(dBm)	(dBm)	(dB)
50	24.10	27.05	15.62	13.07	1.04	0.75	50	19.87	5.53	1.71
100	23.90	26.85	15.28	14.11	1.04	0.75	100	19.04	5.62	2.00
200	23.99	26.69	15.56	14.49	1.04	0.76	150	19.88	5.57	1.77
400	23.71	26.46	15.77	12.99	1.03	0.76	200	19.16	5.01	1.52
600	23.09	26.51	15.59	12.81	1.06	0.71	250	19.03	5.27	1.70
800	22.55	26.29	17.12	12.35	1.06	0.68	300	19.28	5.44	2.14
1000	21.96	25.88	17.04	12.27	1.07	0.67	350	19.66	6.08	1.82
1200	21.49	25.40	17.58	11.55	1.06	0.66	400	19.11	5.68	1.65
1400	20.82	25.22	17.13	11.08	1.08	0.63	450	19.09	5.53	1.70
1600	20.21	24.88	17.98	11.15	1.09	0.60	500	19.04	5.50	1.96
1800	19.65	24.52	17.49	11.11	1.10	0.59	550	18.81	5.23	1.96
2000	19.20	24.02	17.43	10.94	1.08	0.59	600	18.66	5.15	1.68
2200	18.64	23.69	17.29	10.81	1.09	0.57	650	18.92	5.64	1.70
2400	18.16	23.36	16.86	10.80	1.10	0.56	700	19.08	5.27	1.90
2600	17.77	22.93	16.86	11.00	1.10	0.56	750	18.92	5.51	1.91
2800	17.39	22.56	16.27	11.10	1.09	0.55	800	19.35	5.51	1.76
3000	16.96	22.28	15.97	11.30	1.10	0.54	850	18.71	5.37	1.69
3200	16.64	21.98	15.31	11.68	1.10	0.53	900	18.98	5.50	1.90
3400	16.31	21.74	15.24	11.66	1.10	0.53	950	18.77	5.39	1.97
3600	16.09	21.36	14.81	11.65	1.08	0.53	1000	19.22	5.48	1.71
3800	15.76	21.26	14.66	11.77	1.10	0.52	1100	19.24	5.29	1.80
4000	15.58	20.91	14.62	11.83	1.09	0.53	1200	19.12	4.97	1.77
4200	15.37	20.73	14.09	11.66	1.09	0.53	1300	19.37	4.97	1.80
4400	15.20	20.52	14.14	11.52	1.09	0.54	1400	19.15	5.00	1.87
4600	15.04	20.29	13.40	11.00	1.07	0.55	1500	19.06	4.85	1.94
4800	14.84	20.17	13.42	10.65	1.08	0.55	1600	19.32	4.64	1.92
5000	14.80	19.93	12.74	10.02	1.05	0.57	1700	19.81	4.70	1.79
5500	14.57	19.68	11.54	8.42	1.03	0.60	1800	19.65	4.73	1.96
6000	13.95	19.62	8.97	6.35	1.00	0.63	1900	19.55	4.86	1.75
6500	12.95	19.93	6.81	4.81	1.00	0.66	2000	19.45	4.55	1.82
7000	11.56	20.20	5.45	4.03	1.02	0.66	2100	19.16	4.79	1.79
7500	9.78	20.21	4.79	3.76	1.10	0.64	2200	19.91	4.99	1.83
8000	8.00	19.62	4.53	3.75	1.17	0.62	2300	20.18	5.10	1.79
9000	4.36	17.98	3.89	3.55	1.27	0.62	2400	20.48	5.21	1.87
10000	1.57	15.49	3.56	3.53	1.23	0.62	2500	19.92	5.36	1.75
11000	0.38	12.11	4.21	4.34	1.15	0.59	2600	19.92	5.23	1.87
12000	0.02	8.83	4.93	5.44	1.06	0.62	2700	19.85	5.22	1.79
13000	-0.60	6.02	5.36	6.34	1.00	0.67	2800	19.82	5.12	1.83
14000	-1.77	4.74	4.82	5.49	0.98	0.74	2900	19.43	5.26	1.77
15000	-4.68	6.22	3.03	3.09	1.02	0.75	3000	19.53	5.22	1.73

REV. X1

GALI-S66+

120123

Page 6 of 11



IF/RF MICROWAVE COMPONENTS • ISO 9001 ISO 14001 AS 9100 CERTIFIED • RoHS compliant

P.O. Box 350166, Brooklyn, New York 11235-0003 (718) 934-4500 Fax (718) 332-4661



The Design Engineers Search Engine finds the model you need, Instantly • For detailed performance specs & shopping online see



Typical Performance Data

Definitions:

Input Return Loss = -S11 (dB)

Gain(Power Gain) = S21 (dB)

Reverse Isolation = -S12 (dB)

Output Return Loss = -S22 (dB)

TEST CONDITIONS: Icc = 16mA, Vd = 3.20V @Temperature = +85degC

FREQ	Gain	Isolation	Input Return Loss	Output Return Loss	Stability		FREQ	IP3 Output	1dB Comp. Output	Noise Figure
					K	Delta				
(MHz)	(dB)	(dB)	(dB)	(dB)	K	Delta	(MHz)	(dBm)	(dBm)	(dB)
50	21.36	24.48	26.10	22.36	1.06	0.70	50	19.94	3.64	2.46
100	21.59	24.04	27.70	27.98	1.04	0.76	100	19.48	3.81	2.63
200	21.38	24.11	30.34	23.95	1.05	0.73	150	20.57	3.82	2.56
400	20.99	24.19	26.32	19.16	1.06	0.69	200	18.55	3.89	2.47
600	20.75	23.88	23.95	17.52	1.04	0.69	250	18.11	3.76	2.55
800	20.20	23.73	21.17	15.55	1.04	0.65	300	18.79	3.52	2.81
1000	19.88	23.56	18.73	14.41	1.03	0.63	350	19.12	3.89	2.58
1200	19.22	23.54	17.43	13.43	1.05	0.58	400	17.87	3.54	2.63
1400	18.79	23.13	17.29	12.75	1.04	0.58	450	17.98	3.58	2.60
1600	18.09	22.86	16.51	12.20	1.05	0.54	500	17.59	3.55	2.65
1800	17.72	22.53	15.77	11.68	1.04	0.53	550	17.07	3.40	2.73
2000	17.17	22.43	14.87	11.34	1.05	0.50	600	17.04	2.97	2.61
2200	16.60	22.20	14.71	11.22	1.07	0.48	650	17.39	2.62	2.62
2400	16.33	21.80	14.18	11.10	1.05	0.48	700	17.40	2.59	2.61
2600	15.89	21.74	13.35	11.13	1.06	0.45	750	17.24	2.86	2.67
2800	15.46	21.50	13.05	11.15	1.07	0.44	800	17.52	2.90	2.72
3000	15.19	21.13	12.80	11.26	1.06	0.44	850	16.91	2.69	2.64
3200	14.79	20.88	12.35	11.50	1.07	0.43	900	16.98	2.61	2.69
3400	14.58	20.61	12.10	11.58	1.06	0.44	950	16.81	3.02	2.82
3600	14.32	20.44	11.65	11.67	1.06	0.43	1000	17.03	3.31	2.67
3800	14.03	20.25	11.86	11.96	1.08	0.43	1100	17.12	2.97	2.64
4000	13.85	20.02	11.63	11.92	1.07	0.43	1200	16.98	2.49	2.74
4200	13.63	19.77	11.92	11.97	1.08	0.44	1300	16.99	2.29	2.66
4400	13.59	19.56	12.00	11.83	1.07	0.45	1400	16.79	2.57	2.85
4600	13.34	19.42	11.92	11.51	1.07	0.45	1500	17.09	2.40	2.82
4800	13.23	19.14	11.70	11.04	1.05	0.46	1600	17.33	2.43	2.86
5000	13.11	19.12	11.30	10.57	1.05	0.46	1700	17.73	2.44	2.73
5500	12.74	18.88	10.27	8.98	1.02	0.47	1800	17.37	2.67	2.86
6000	12.14	18.81	9.23	7.27	1.01	0.49	1900	17.45	2.66	2.76
6500	11.22	18.80	8.01	5.99	1.02	0.51	2000	17.16	2.57	2.70
7000	9.78	19.10	6.78	5.10	1.09	0.51	2100	16.92	2.53	2.85
7500	7.96	19.51	5.87	4.78	1.25	0.50	2200	17.62	2.96	2.73
8000	6.08	19.16	5.38	4.44	1.36	0.50	2300	17.93	2.92	2.82
9000	2.61	17.94	4.66	4.30	1.56	0.50	2400	18.22	3.22	2.81
10000	0.28	15.34	4.48	4.52	1.51	0.49	2500	17.44	3.36	2.77
11000	-1.04	12.30	5.06	5.03	1.40	0.48	2600	17.22	3.18	2.85
12000	-1.53	9.27	5.45	6.18	1.24	0.49	2700	17.26	2.89	2.81
13000	-1.64	6.16	6.69	8.03	1.14	0.55	2800	17.10	2.92	2.78
14000	-3.15	5.48	5.08	5.46	1.11	0.65	2900	16.70	2.97	2.81
15000	-5.74	6.74	3.42	3.59	1.15	0.66	3000	16.81	2.97	2.60

REV. X1

GALI-S66+

120123

Page 7 of 11



IF/RF MICROWAVE COMPONENTS • ISO 9001 ISO 14001 AS 9100 CERTIFIED • RoHS compliant

P.O. Box 350166, Brooklyn, New York 11235-0003 (718) 934-4500 Fax (718) 332-4661



The Design Engineers Search Engine finds the model you need, Instantly • For detailed performance specs & shopping online see



Typical Performance Data

Definitions:

Input Return Loss = -S11 (dB)

Gain(Power Gain) = S21 (dB)

Reverse Isolation = -S12 (dB)

Output Return Loss = -S22 (dB)

TEST CONDITIONS: Icc = 13mA, Vd = 3.17V @Temperature = +85degC

FREQ	Gain	Isolation	Input Return Loss	Output Return Loss	Stability		FREQ	IP3 Output	1dB Comp. Output	Noise Figure
					K	Delta				
(MHz)	(dB)	(dB)	(dB)	(dB)	K	Delta	(MHz)	(dBm)	(dBm)	(dB)
50	19.59	22.83	14.79	13.09	1.05	0.73	50	17.53	0.51	2.54
100	19.83	22.77	16.05	15.52	1.05	0.74	100	17.26	0.24	2.59
200	19.92	23.01	17.34	14.27	1.05	0.72	150	17.92	0.48	2.62
400	19.39	23.08	15.26	13.05	1.06	0.68	200	16.48	0.03	2.63
600	19.24	22.81	14.99	13.47	1.04	0.67	250	16.22	0.36	2.65
800	18.57	22.72	13.89	12.83	1.04	0.62	300	15.99	0.28	2.74
1000	18.42	22.32	13.83	12.68	1.01	0.62	350	16.73	1.23	2.63
1200	17.87	22.26	13.06	11.80	1.01	0.58	400	15.99	0.22	2.81
1400	17.48	21.91	12.55	11.65	0.99	0.56	450	15.46	0.10	2.70
1600	16.94	21.82	12.44	11.22	1.00	0.52	500	15.60	0.51	2.63
1800	16.70	21.46	12.45	11.00	0.98	0.52	550	14.68	0.57	2.76
2000	16.32	21.31	12.36	10.60	0.98	0.50	600	14.71	0.07	2.80
2200	15.72	21.25	11.50	10.45	0.99	0.46	650	14.96	0.34	2.76
2400	15.47	20.75	11.22	10.46	0.97	0.47	700	14.86	0.40	2.61
2600	15.18	20.61	11.20	10.42	0.97	0.46	750	14.47	0.38	2.68
2800	14.66	20.49	10.42	10.34	0.98	0.43	800	14.93	0.65	2.86
3000	14.40	20.13	10.10	10.58	0.96	0.43	850	14.19	0.44	2.77
3200	14.03	20.06	9.84	10.69	0.98	0.41	900	14.46	0.22	2.71
3400	13.89	19.71	9.92	10.89	0.97	0.42	950	14.62	0.34	2.82
3600	13.72	19.53	9.83	10.90	0.97	0.42	1000	14.48	0.17	2.80
3800	13.33	19.40	9.40	11.28	0.98	0.41	1100	14.71	0.19	2.66
4000	13.35	19.16	9.85	11.24	0.98	0.43	1200	14.66	0.69	2.85
4200	13.09	19.02	9.56	11.36	0.98	0.42	1300	14.51	0.27	2.70
4400	13.07	18.69	9.77	11.51	0.97	0.44	1400	14.52	0.88	2.94
4600	12.87	18.62	9.59	11.33	0.97	0.43	1500	14.63	0.59	2.87
4800	12.80	18.21	9.68	11.18	0.95	0.45	1600	14.82	0.69	2.94
5000	12.69	18.25	9.27	10.76	0.94	0.44	1700	15.15	0.41	2.80
5500	12.39	17.91	8.95	9.45	0.92	0.47	1800	14.47	0.61	2.94
6000	11.93	17.76	8.36	7.75	0.90	0.49	1900	14.51	0.24	2.84
6500	10.99	17.70	7.27	6.41	0.90	0.50	2000	14.54	0.51	2.74
7000	9.58	18.29	6.39	5.56	1.00	0.49	2100	14.30	0.42	2.92
7500	7.77	18.69	5.70	5.18	1.16	0.48	2200	15.05	0.58	2.74
8000	5.92	18.68	5.27	4.88	1.31	0.48	2300	15.59	0.30	2.92
9000	2.46	17.81	4.69	4.67	1.58	0.47	2400	16.04	0.15	2.81
10000	0.10	15.46	4.50	4.87	1.55	0.46	2500	15.43	0.28	2.86
11000	-1.22	12.53	5.07	5.29	1.44	0.45	2600	15.07	0.09	2.85
12000	-1.76	9.50	5.40	6.35	1.27	0.47	2700	14.99	0.26	2.93
13000	-1.81	6.29	6.56	8.18	1.15	0.53	2800	15.06	0.38	2.80
14000	-3.27	5.51	5.04	5.49	1.12	0.64	2900	14.65	0.20	2.91
15000	-5.86	6.71	3.42	3.60	1.15	0.66	3000	15.13	0.25	2.58

REV. X1
GALI-S66+
120123
Page 8 of 11



IF/RF MICROWAVE COMPONENTS • ISO 9001 ISO 14001 AS 9100 CERTIFIED • RoHS compliant
P.O. Box 350166, Brooklyn, New York 11235-0003 (718) 934-4500 Fax (718) 332-4661



The Design Engineers Search Engine finds the model you need, Instantly • For detailed performance specs & shopping online see



Typical Performance Data

Definitions:

Input Return Loss = -S11 (dB)

Gain(Power Gain) = S21 (dB)

Reverse Isolation = -S12 (dB)

Output Return Loss = -S22 (dB)

TEST CONDITIONS: Icc = 19mA, Vd = 3.22V @Temperature = +85degC

FREQ	Gain	Isolation	Input Return Loss	Output Return Loss	Stability		FREQ	IP3 Output	1dB Comp. Output	Noise Figure
					K	Delta				
(MHz)	(dB)	(dB)	(dB)	(dB)	K	Delta	(MHz)	(dBm)	(dBm)	(dB)
50	22.44	24.83	28.87	25.42	1.04	0.76	50	21.06	5.96	2.40
100	22.58	25.07	23.79	25.05	1.04	0.75	100	20.87	6.10	2.67
200	22.39	24.89	24.68	24.02	1.04	0.75	150	21.96	6.37	2.52
400	21.99	24.78	27.28	19.57	1.04	0.73	200	20.73	5.91	2.35
600	21.50	24.90	25.19	17.44	1.06	0.67	250	20.03	6.18	2.52
800	21.10	24.79	24.09	15.20	1.06	0.65	300	20.35	5.69	2.84
1000	20.64	24.55	22.69	14.29	1.06	0.63	350	20.76	6.01	2.57
1200	20.02	24.14	20.77	13.27	1.06	0.61	400	19.73	5.55	2.52
1400	19.33	24.03	19.87	12.52	1.08	0.57	450	19.63	5.59	2.54
1600	18.79	23.75	19.02	11.98	1.08	0.55	500	19.56	5.45	2.67
1800	18.28	23.51	18.08	11.58	1.09	0.53	550	19.18	5.70	2.72
2000	17.78	23.04	17.04	11.26	1.08	0.52	600	19.13	5.12	2.53
2200	17.17	22.81	16.50	11.16	1.10	0.49	650	19.36	5.47	2.57
2400	16.73	22.56	15.86	11.09	1.10	0.48	700	19.27	5.41	2.64
2600	16.36	22.21	15.16	11.21	1.09	0.47	750	19.01	5.57	2.67
2800	15.90	21.88	14.53	11.25	1.10	0.46	800	19.41	5.17	2.61
3000	15.52	21.71	14.34	11.33	1.11	0.45	850	19.01	5.14	2.56
3200	15.23	21.43	14.08	11.62	1.12	0.45	900	19.19	5.07	2.71
3400	14.95	21.20	13.89	11.67	1.12	0.44	950	18.91	5.45	2.80
3600	14.74	20.87	13.32	11.82	1.10	0.45	1000	19.29	5.40	2.59
3800	14.41	20.78	13.54	12.06	1.13	0.44	1100	19.16	5.21	2.63
4000	14.26	20.48	13.26	12.02	1.11	0.44	1200	19.12	5.09	2.68
4200	13.98	20.23	13.34	11.97	1.12	0.45	1300	19.33	5.23	2.65
4400	13.82	20.13	13.43	11.73	1.12	0.45	1400	18.99	5.15	2.78
4600	13.63	19.88	13.15	11.32	1.11	0.46	1500	18.96	4.88	2.80
4800	13.48	19.75	13.10	10.83	1.11	0.46	1600	19.36	5.04	2.81
5000	13.33	19.52	12.24	10.22	1.09	0.47	1700	19.82	5.02	2.69
5500	12.98	19.37	11.30	8.57	1.07	0.49	1800	19.54	4.79	2.87
6000	12.32	19.25	9.79	6.98	1.05	0.50	1900	19.28	5.15	2.72
6500	11.33	19.46	8.32	5.77	1.08	0.51	2000	19.20	5.12	2.68
7000	9.90	19.70	6.99	4.90	1.16	0.52	2100	18.86	5.03	2.79
7500	8.08	19.79	5.96	4.53	1.27	0.52	2200	19.40	4.99	2.72
8000	6.22	19.48	5.41	4.26	1.39	0.52	2300	19.68	5.36	2.77
9000	2.74	18.06	4.63	4.10	1.55	0.51	2400	19.56	5.37	2.79
10000	0.39	15.25	4.44	4.38	1.48	0.51	2500	18.90	5.45	2.72
11000	-0.93	12.22	5.07	4.90	1.38	0.49	2600	18.58	5.28	2.85
12000	-1.39	9.16	5.49	6.00	1.23	0.51	2700	18.80	5.31	2.76
13000	-1.53	6.09	6.73	8.00	1.14	0.56	2800	18.45	5.29	2.80
14000	-3.06	5.47	5.08	5.40	1.11	0.65	2900	18.11	5.14	2.76
15000	-5.71	6.72	3.44	3.59	1.15	0.66	3000	18.19	5.20	2.63

REV. X1
GALI-S66+
120123
Page 9 of 11



IF/RF MICROWAVE COMPONENTS • ISO 9001 ISO 14001 AS 9100 CERTIFIED • RoHS compliant
P.O. Box 350166, Brooklyn, New York 11235-0003 (718) 934-4500 Fax (718) 332-4661



The Design Engineers Search Engine finds the model you need, Instantly • For detailed performance specs & shopping online see



Typical Performance Curves

GAIN vs. TEMPERATURE

INPUT POWER = -27dBm, CURRENT = 16mA

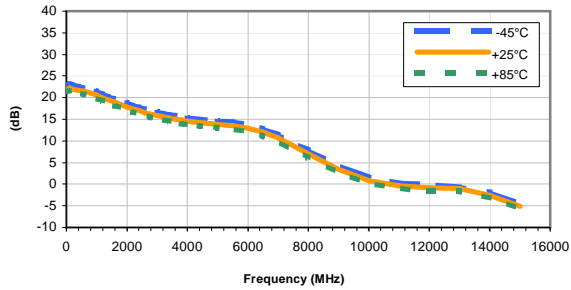

GAIN vs. CURRENT

INPUT POWER = -27dBm, Temperature = +25°C

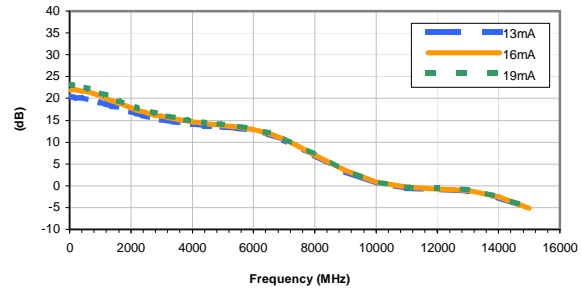

ISOLATION vs. TEMPERATURE

INPUT POWER = -27dBm, CURRENT = 16mA

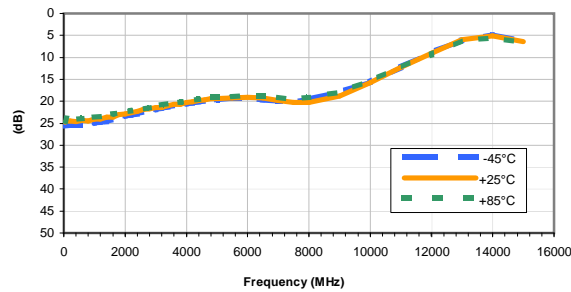

ISOLATION vs. CURRENT

INPUT POWER = -27dBm, Temperature = +25°C

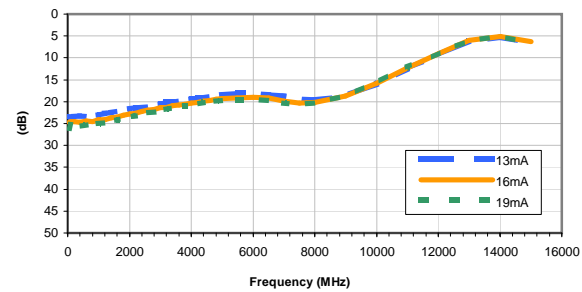

INPUT RETURN LOSS vs. TEMPERATURE

INPUT POWER = -27dBm, CURRENT = 16mA

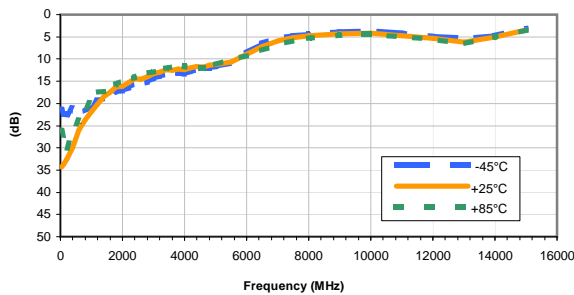

INPUT RETURN LOSS vs. CURRENT

INPUT POWER = -27dBm, Temperature = +25°C

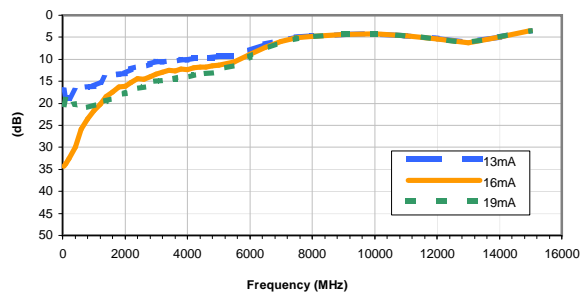

OUTPUT RETURN LOSS vs. TEMPERATURE

INPUT POWER = -27dBm, CURRENT = 16mA

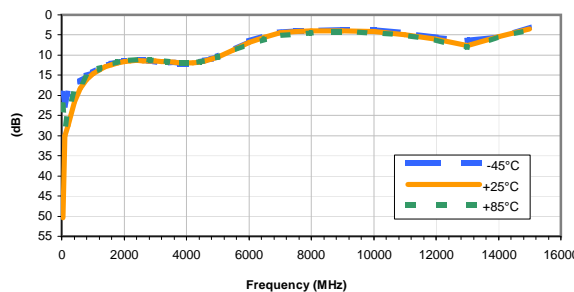

OUTPUT RETURN LOSS vs. CURRENT

INPUT POWER = -27dBm, Temperature = +25°C

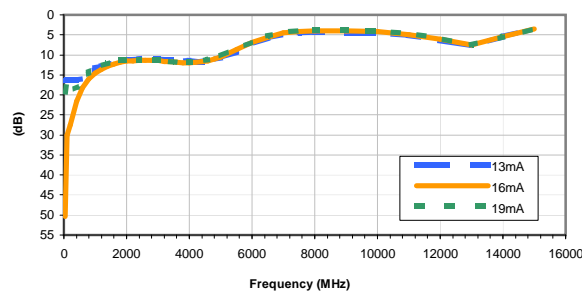

IF/RF MICROWAVE COMPONENTS • ISO 9001 ISO 14001 AS 9100 CERTIFIED • RoHS compliant
P.O. Box 350166, Brooklyn, New York 11235-0003 (718) 934-4500 Fax (718) 332-4661



The Design Engineers Search Engine finds the model you need, Instantly • For detailed performance specs & shopping online see



Typical Performance Curves

OUTPUT IP3 vs. TEMPERATURE

INPUT POWER = -27dBm, CURRENT = 16mA

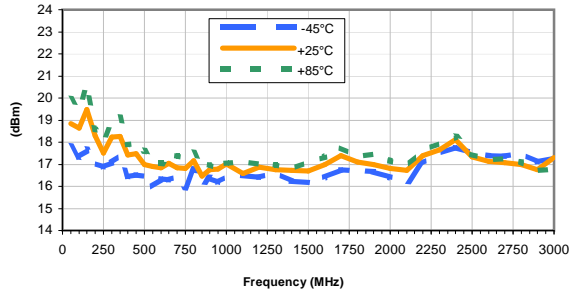

OUTPUT IP3 vs. CURRENT

INPUT POWER = -27dBm, Temperature = +25°C

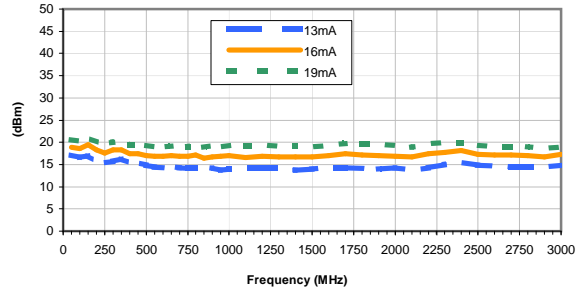

OUTPUT POWER at 1dB Compression vs. TEMPERATURE

CURRENT = 16mA

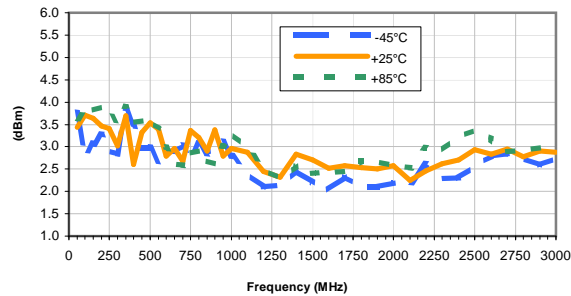

OUTPUT POWER at 1dB Compression vs. CURRENT

Temperature = +25°C

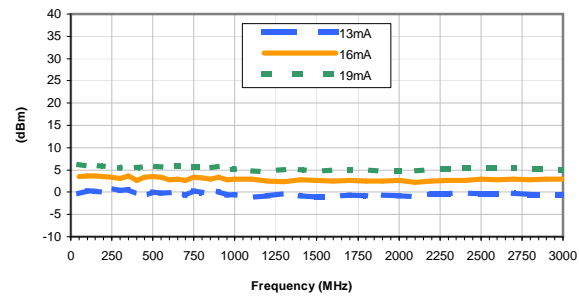

Noise Figure vs. TEMPERATURE

CURRENT = 16mA

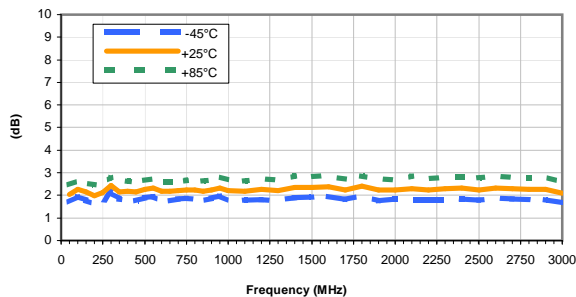

Noise Figure vs. CURRENT

Temperature = +25°C

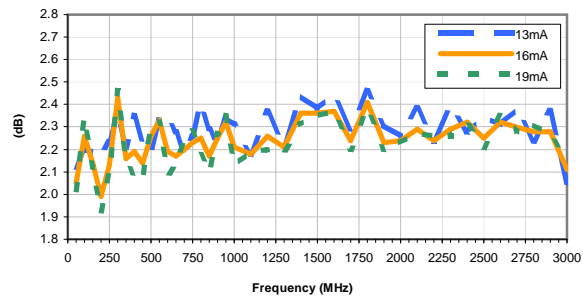

Typical Performance Curves

GAIN vs. TEMPERATURE

INPUT POWER = -27dBm, CURRENT = 16mA

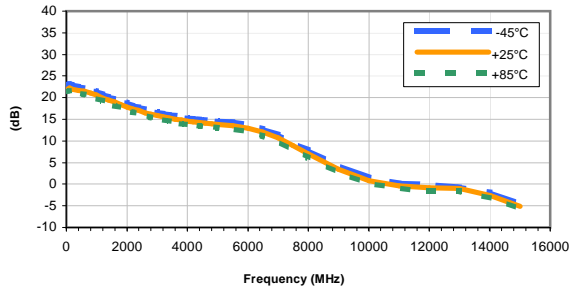

GAIN vs. CURRENT

INPUT POWER = -27dBm, Temperature = +25°C

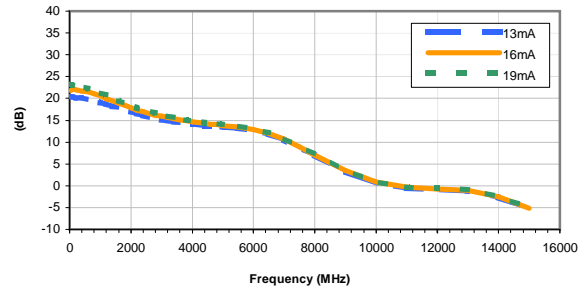

ISOLATION vs. TEMPERATURE

INPUT POWER = -27dBm, CURRENT = 16mA

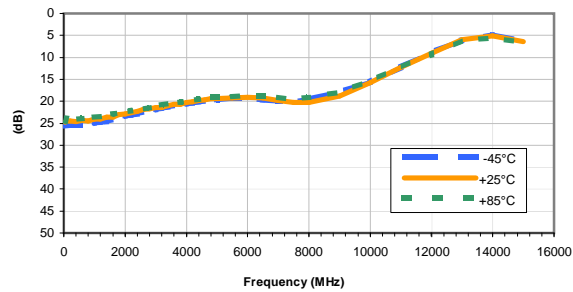

ISOLATION vs. CURRENT

INPUT POWER = -27dBm, Temperature = +25°C

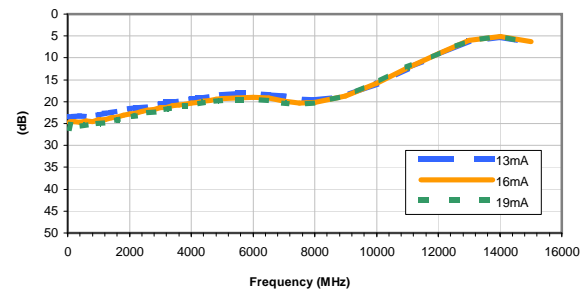

INPUT RETURN LOSS vs. TEMPERATURE

INPUT POWER = -27dBm, CURRENT = 16mA

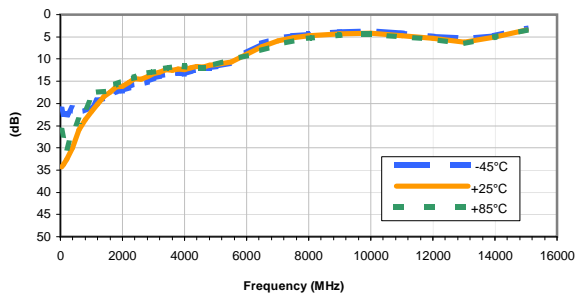

INPUT RETURN LOSS vs. CURRENT

INPUT POWER = -27dBm, Temperature = +25°C

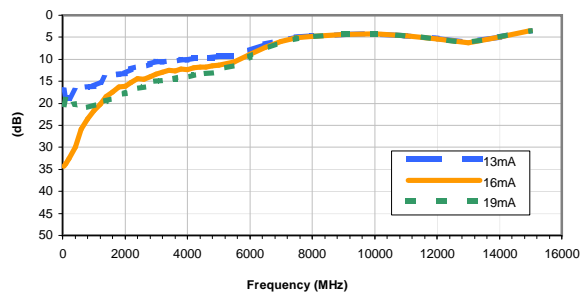

OUTPUT RETURN LOSS vs. TEMPERATURE

INPUT POWER = -27dBm, CURRENT = 16mA

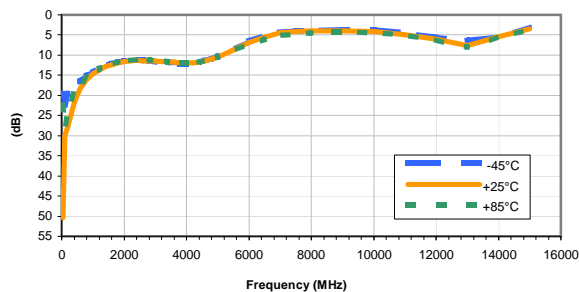

OUTPUT RETURN LOSS vs. CURRENT

INPUT POWER = -27dBm, Temperature = +25°C

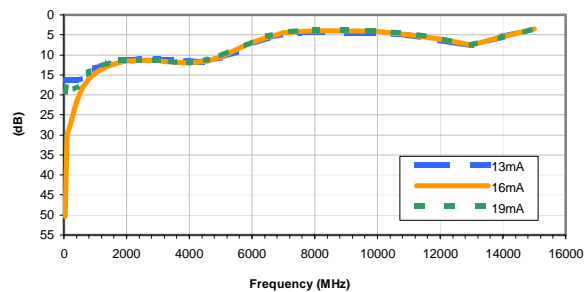

IF/RF MICROWAVE COMPONENTS • ISO 9001 ISO 14001 AS 9100 CERTIFIED • RoHS compliant
P.O. Box 350166, Brooklyn, New York 11235-0003 (718) 934-4500 Fax (718) 332-4661



The Design Engineers Search Engine finds the model you need, Instantly • For detailed performance specs & shopping online see



Typical Performance Curves

OUTPUT IP3 vs. TEMPERATURE

INPUT POWER = -27dBm, CURRENT = 16mA

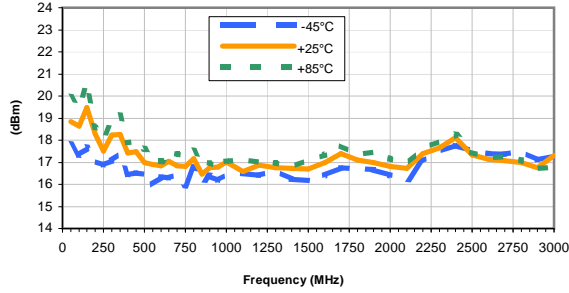

OUTPUT IP3 vs. CURRENT

INPUT POWER = -27dBm, Temperature = +25°C

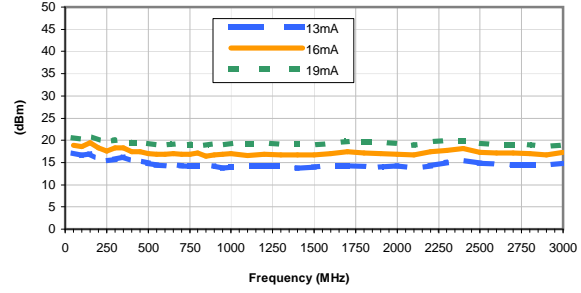

OUTPUT POWER at 1dB Compression vs. TEMPERATURE

CURRENT = 16mA

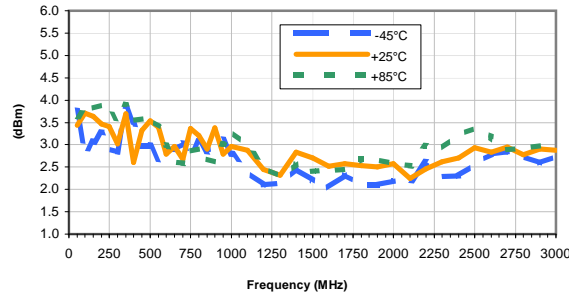

OUTPUT POWER at 1dB Compression vs. CURRENT

Temperature = +25°C

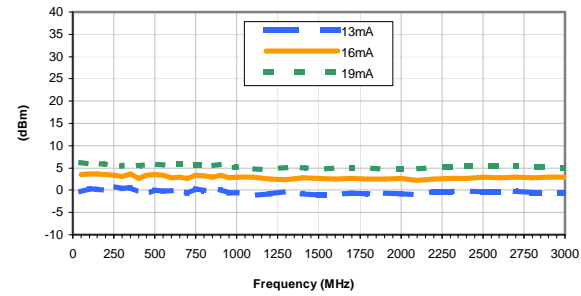

Noise Figure vs. TEMPERATURE

CURRENT = 16mA

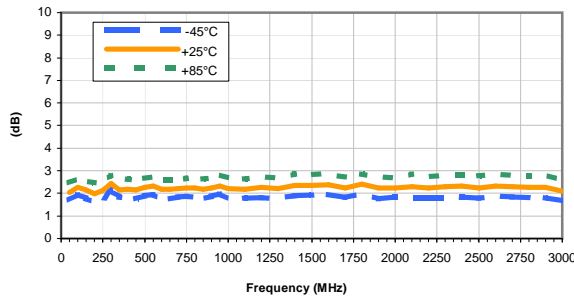

Noise Figure vs. CURRENT

Temperature = +25°C

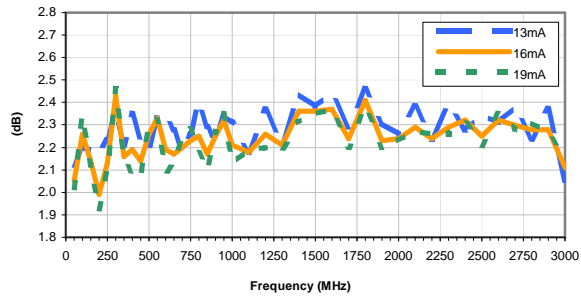

IF/RF MICROWAVE COMPONENTS • ISO 9001 ISO 14001 AS 9100 CERTIFIED • RoHS compliant
P.O. Box 350166, Brooklyn, New York 11235-0003 (718) 934-4500 Fax (718) 332-4661



The Design Engineers Search Engine finds the model you need, Instantly • For detailed performance specs & shopping online see



Outline Dimensions

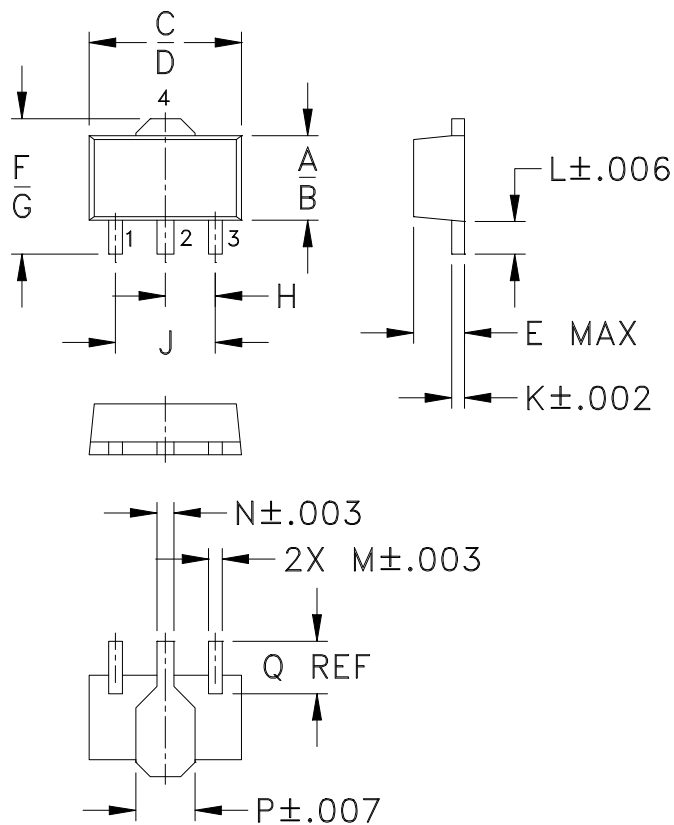

PCB Land Pattern

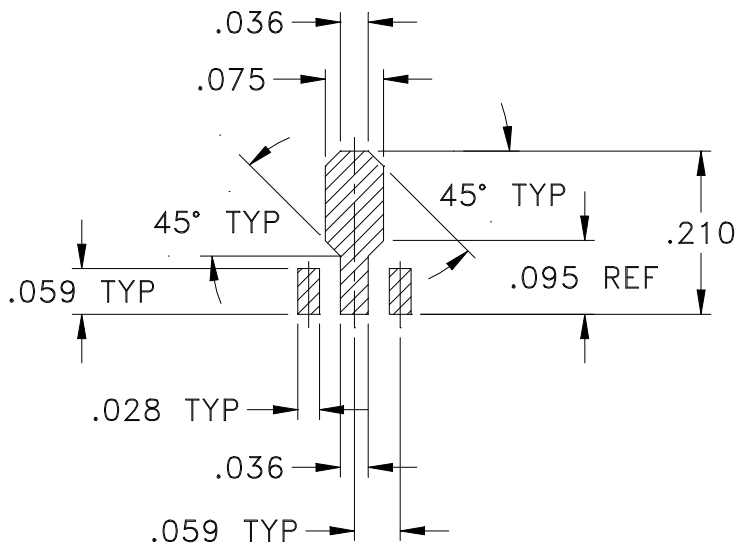

Suggested Layout,
Tolerance to be within $\pm .002$

CASE #	A	B	C	D	E	F	G	H	J	K	L	M
DF782	.102 (2.59)	.090 (2.29)	.181 (4.60)	.173 (4.39)	.063 (1.60)	.167 (4.24)	.155 (3.94)	.059 (1.50)	.118 (3.00)	.015 (0.38)	.041 (1.04)	.016 (0.41)

CASE #	N	P	Q	WT. GRAM
DF782	.019 (0.48)	.065 (1.65)	.062 (1.57)	.2

Dimensions are in inches (mm). Tolerances: 2 Pl. $\pm .01$; 3Pl. $\pm .005$

Notes:

- Case material: Plastic.
- Termination finish:
 For RoHS Case Styles: Tin-Silver alloy plate over Nickel barrier or Matte-Tin.
 All models, (+) suffix. See model Data sheet.
 For RoHS-5 Case Styles: Tin-Lead plate. All models, no (+) suffix.



INTERNET <http://www.minicircuits.com>

P.O. Box 350166, Brooklyn, New York 11235-0003 (718) 934-4500 Fax (718) 332-4661

Distribution Centers NORTH AMERICA 800-654-7949 • 417-335-5935 • Fax 417-335-5945 • EUROPE 44-1252-832600 • Fax 44-1252-837010

Mini-Circuits ISO 9001 & ISO 14001 Certified

Tape & Reel Packaging TR-F55

DEVICE ORIENTATION IN T&R

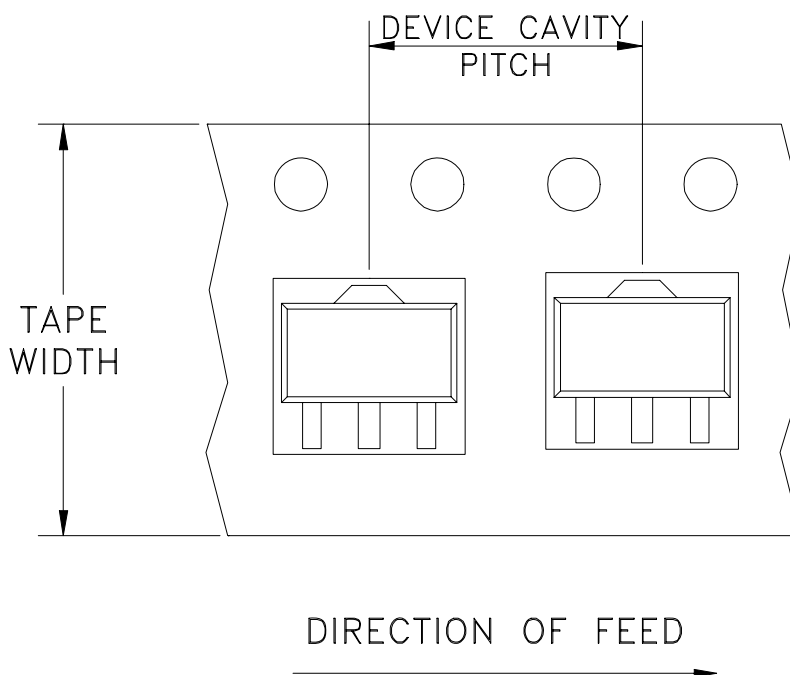

Tape Width, mm	Device Cavity Pitch, mm	Reel Size, inches	Devices per Reel	
12	8	7	Small quantity standard (see note)	20
				50
				100
				200
				500
			Standard	1000

Note: Please consult individual model data sheet to determine device per reel availability.

Mini-Circuits carrier tape materials provide protection from ESD (Electro-Static Discharge) during handling and transportation. Tapes are static dissipative and comply with industry standards EIA-481/EIA-541.

Go to: www.minicircuits.com/pages/pdfs/tape.pdf



INTERNET <http://www.minicircuits.com>

P.O. Box 350166, Brooklyn, New York 11235-0003 (718) 934-4500 Fax (718) 332-4661

Distribution Centers NORTH AMERICA 800-654-7949 • 417-335-5935 • Fax 417-335-5945 • EUROPE 44-1252-832600 • Fax 44-1252-837010

Mini-Circuits ISO 9001 & ISO 14001 Certified

THIRD ANGLE PROJECTION

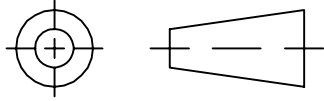

REVISIONS

REV	ECN No.	DESCRIPTION	DATE	DR	AUTH
A	M76190	CHANGED DISCRIPTION	04/01	GF	CT
B	M82575	UPDATED DRAWING	08/05/02	AV	LC
C	M102713	ADDED NOTE 2 & "...WITH SMOBC"	01/17/06	MMG	IL
D	M108434	UPDATED DRAWING PER TB-409+	11/14/06	PW	IG

SUGGESTED MOUNTING CONFIGURATION
FOR DF782 CASE STYLE, "mz" PIN CONNECTION

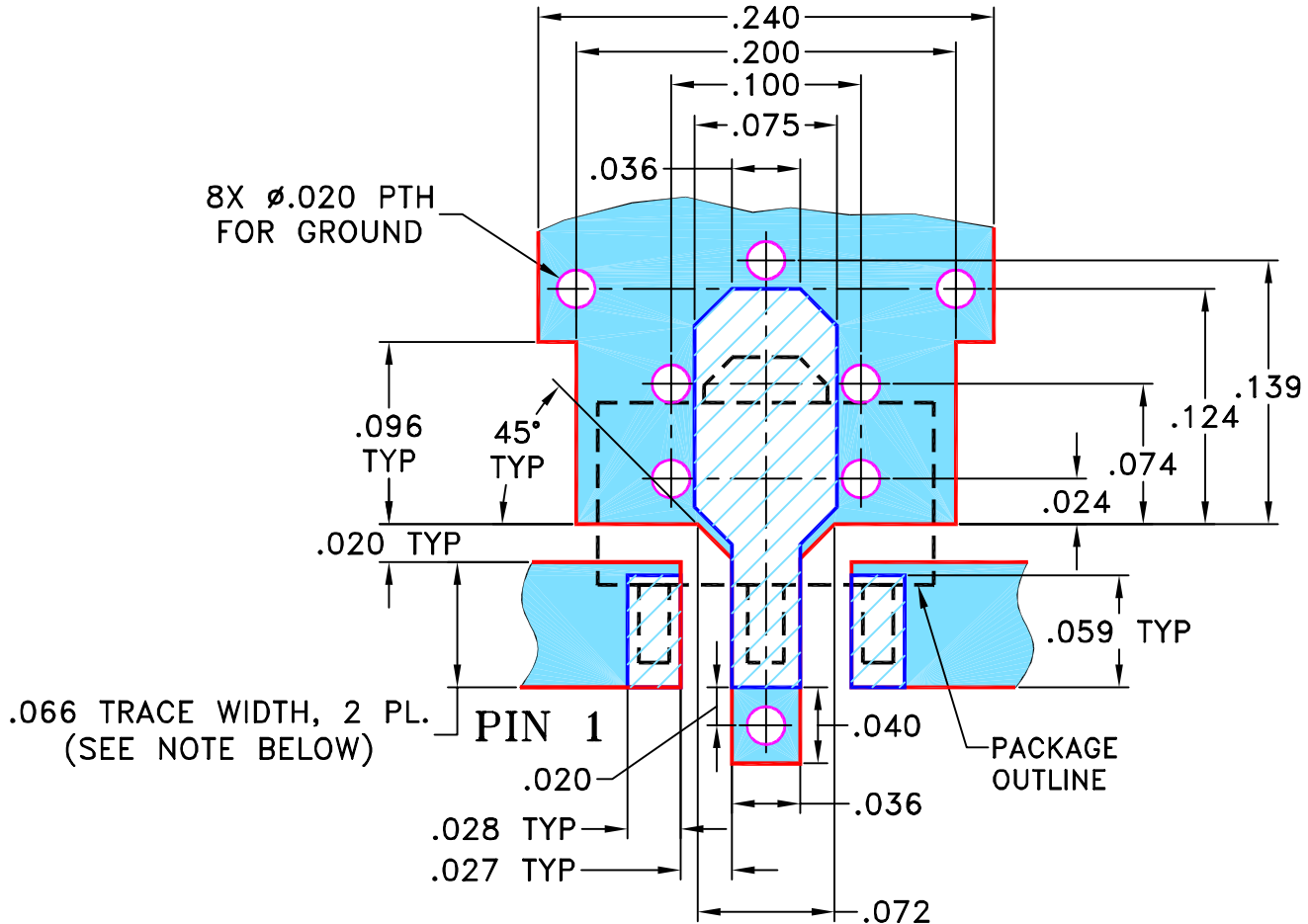

- NOTES:** 1. TRACE WIDTH IS SHOWN FOR ROGERS R04350B WITH DIELECTRIC THICKNESS .030" ± .002"; COPPER: 1/2 OZ. EACH SIDE. FOR OTHER MATERIALS TRACE WIDTH MAY NEED TO BE MODIFIED.
2. BOTTOM SIDE OF THE PCB IS CONTINUOUS GROUND PLANE.



DENOTES PCB COPPER LAYOUT WITH SMOBC (SOLDER MASK OVER BARE COPPER)



DENOTES COPPER LAND PATTERN FREE OF SOLDER MASK

UNLESS OTHERWISE SPECIFIED

INITIALS

DATE

DIMENSIONS ARE IN INCHES

TOLERANCES ON:

2 PL DECIMALS ±

3 PL DECIMALS ± .005

ANGLES ±

FRACTIONS ±



Mini-Circuits®

THIS DOCUMENT AND ITS CONTENTS ARE THE PROPERTY OF MINI-CIRCUITS. EXCEPT FOR USE EXPRESSLY GRANTED, IN WRITING, TO ITS VENDORS, VENDEE AND THE UNITED STATES GOVERNMENT, MINI-CIRCUITS RESERVES ALL PROPRIETARY DESIGN, USE, MANUFACTURING AND REPRODUCTION RIGHTS THERETO. THESE CONTENTS SHALL NOT BE USED, DUPLICATED OR DISCLOSED TO ANY OUTSIDE PARTY, IN WHOLE OR IN PART, WITHOUT WRITTEN PERMISSION OF MINI-CIRCUITS.

ASHEETA1.DWG REV:A DATE:01/12/95



Mini-Circuits®

13 Neptune Avenue
Brooklyn NY 11235

PL, mz, DF782, GALI, TB-409-XXX+

SIZE	CODE IDENT	DRAWING NO:	REV:
A	15542	98-PL-019	D
FILE:	98PL019	SCALE:	10:1
		SHEET:	1 OF 1

Evaluation Board and Circuit

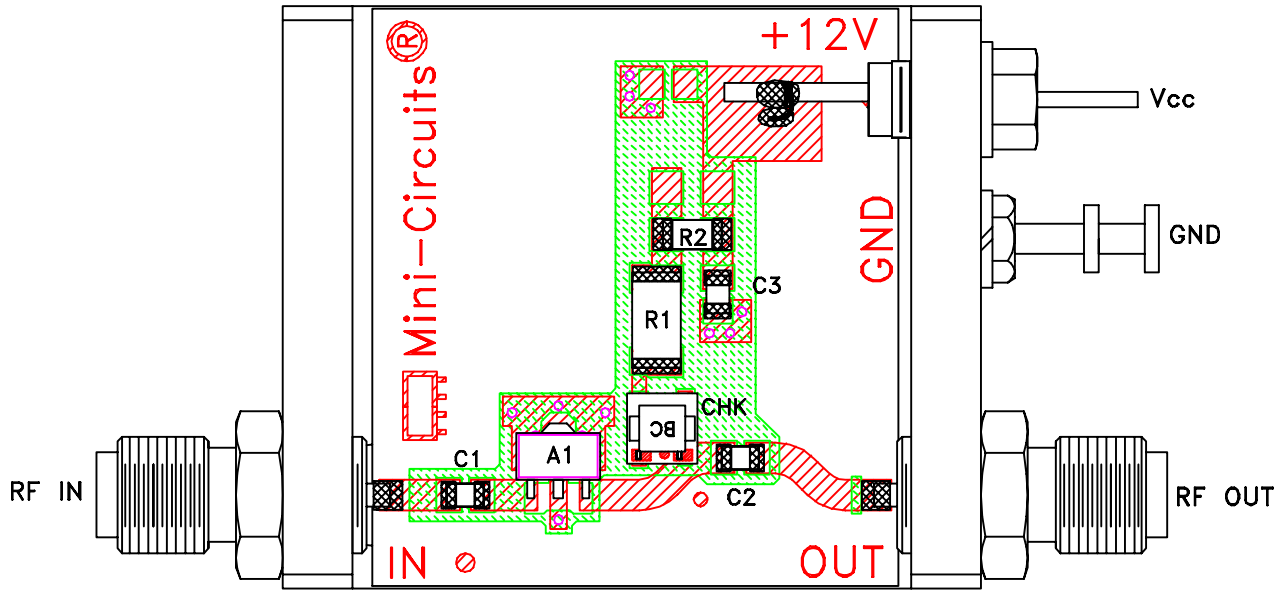

TB-409-S66+

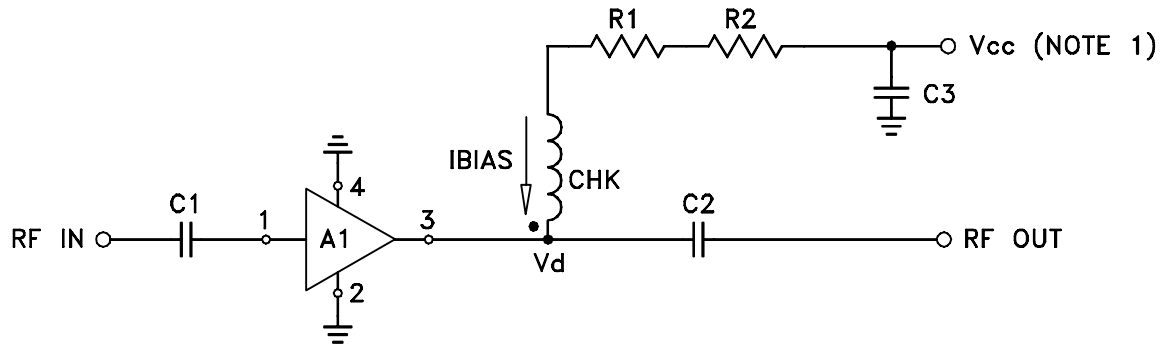

COMPONENT	VALUE
A1	Gali-S66(+)
C1 (NOTE 4)	2400 pF
C2 (NOTE 4)	2400 pF
C3 (bypass)	0.1 μ F
R1	523 Ohms, 0.75W
R2	8.25 Ohms, 0.25W
CHK	Mini-Circuits TCCH-80+

Schematic Diagram

NOTE:

1. Vcc voltage: $+12 \pm 0.2V$.
2. SMA Female connectors.
3. PCB material: Rogers R04350 or equivalent, dielectric constant=3.5, dielectric thickness=.030 inch.
4. Capacitors, C1 & C2 should be free of resonance up to the highest frequency specified.

 **Mini-Circuits®**

All Mini-Circuits products are manufactured under exacting quality assurance and control standards, and are capable of meeting published specifications after being subjected to any or all of the following physical and environmental test.

Specification	Test/Inspection Condition	Reference/Spec
Operating Temperature	-45° to 85°C or -40° to 85°C Ambient Environment	Individual Model Data Sheet
Storage Temperature	-65° to 150° C Ambient Environment	Individual Model Data Sheet
Thermal Shock	-55° to 100°C, 100 cycles	MIL-STD-202, Method 107, Condition A-3, except +100°C
Mechanical Shock	1.5Kg, 0.5 ms, 5 shock pulses, Y1 direction only	MIL-STD-883, Method 2002, Condition B, except Y1 direction only
Vibration (Variable Frequency)	50g peak	MIL-STD-883, Method 2007, Condition B
Autoclave	15 psig, 100% RH, 121°C, 96 hours	JESD22-A102, Condition C
HAST	130°C, 85% RH, 96 hours	JESD22-A110
Solderability	10X Magnification	J-STD-002, Para 4.2.5, Test S, 95% Coverage
Solder Reflow Heat	Sn-Pb Eutetic Process: 240°C peak Pb-Free Process: 260°C peak	J-STD-020, Table 4-1, 4-2 and 5-2; Figure 5-1
Moisture Sensitivity: Level 1	Bake at 125°C for 24 hours Soak at 85°C/85% RH for 168 hours, Reflow 3 cycles at 260°C peak	J-STD-020
Marking Resistance to Solvents	Isopropyl alcohol + mineral spirits at 25°C; terpene defluxer at 25°C; distilled water + proylene glycol monomethyl ether +	MIL-STD-202, Method 215



All Mini-Circuits products are manufactured under exacting quality assurance and control standards, and are capable of meeting published specifications after being subjected to any or all of the following physical and environmental test.

Specification	Test/Inspection Condition	Reference/Spec
	monoethanolamine at 63°C to 70°C	