

Monolithic Amplifier

DC-5 GHz

Product Features

- DC-5 GHz
- Output power, 15.8 dBm typ.
- Internally Matched to 50 Ohms
- Excellent package for heat dissipation, exposed metal bottom
- Flat output power to 10 GHz
- Aqueous washable
- Protected by US Patent 6,943,629



Generic photo used for illustration purposes only

LEE-49+

CASE STYLE: FG873

+RoHS Compliant

The +Suffix identifies RoHS Compliance. See our web site for RoHS Compliance methodologies and qualifications

Typical Applications

- Cellular
- PCS
- Communication receivers & transmitters
- Satellite communication, military

General Description

LEE-49+ (RoHS compliant) is a wideband amplifier offering high dynamic range. It has repeatable performance from lot to lot. It is enclosed in a 3X3mm MCLP molded plastic package.

simplified schematic and pin description

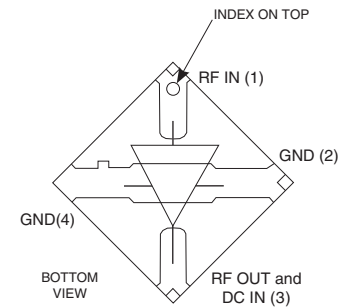
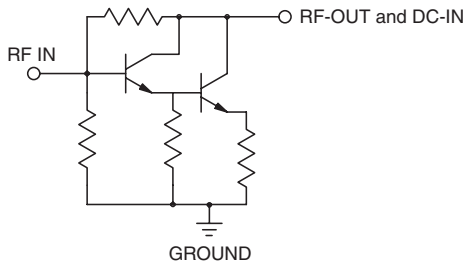

Function	Pin Number	Description
RF IN	1	RF input pin. This pin requires the use of an external DC blocking capacitor chosen for the frequency of operation.
RF-OUT and DC-IN	3	RF output and bias pin. DC voltage is present on this pin; therefore a DC blocking capacitor is necessary for proper operation. An RF choke is needed to feed DC bias without loss of RF signal due to the bias connection, as shown in "Recommended Application Circuit".
GND	2,4	Connections to ground. Use via holes as shown in "Suggested Layout for PCB Design" to reduce ground path inductance for best performance.

Notes

- A. Performance and quality attributes and conditions not expressly stated in this specification document are intended to be excluded and do not form a part of this specification document.
 B. Electrical specifications and performance data contained in this specification document are based on Mini-Circuit's applicable established test performance criteria and measurement instructions.
 C. The parts covered by this specification document are subject to Mini-Circuits standard limited warranty and terms and conditions (collectively, "Standard Terms"); Purchasers of this part are entitled to the rights and benefits contained therein. For a full statement of the Standard Terms and the exclusive rights and remedies thereunder, please visit Mini-Circuits' website at www.minicircuits.com/MCLStore/terms.jsp



Electrical Specifications at 25°C and 65mA, unless noted

Parameter		Min.	Typ.	Max.	Units
Frequency Range*		DC		5	GHz
Gain	f=0.1 GHz	—	14.0	—	dB
	f=1 GHz	—	13.9	—	
	f=2 GHz	12.0	14.3	—	
	f=4 GHz	—	14.0	—	
	f=5 GHz	—	13.1	—	
	f=8 GHz	—	7.8	—	
Input Return Loss	f= DC to 3 GHz		12.5		dB
	f= 3 to 5 GHz		21		
Output Return Loss	f= DC to 3 GHz		15.5		dB
	f= 3 to 5 GHz		15.5		
Output Power @ 1 dB compression	f= 2 GHz	15.8	16.7	—	dBm
	f= 5 GHz	9.7	10.7	—	
Output IP3			33		dBm
Noise Figure			5.5		dB
Recommended Device Operating Current			65		mA
Device Operating Voltage		4.2	4.9	5.3	V
Device Voltage Variation vs. Temperature at 65 mA			-2.9		mV/°C
Device Voltage Variation vs. Current at 25°C			10.4		mV/mA
Thermal Resistance, junction-to-case ¹			151		°C/W

*Guaranteed specification DC-5 GHz. Low frequency cut off determined by external coupling capacitors.

Absolute Maximum Ratings

Parameter	Ratings
Operating Temperature*	-45°C to 85°C
Storage Temperature	-65°C to 150°C
Operating Current	85mA
Input Power	15dBm

Note: Permanent damage may occur if any of these limits are exceeded.
 These ratings are not intended for continuous normal operation.
¹Case is defined as ground leads.
 *Based on typical case temperature rise 5°C above ambient.

Notes

- A. Performance and quality attributes and conditions not expressly stated in this specification document are intended to be excluded and do not form a part of this specification document.
- B. Electrical specifications and performance data contained in this specification document are based on Mini-Circuit's applicable established test performance criteria and measurement instructions.
- C. The parts covered by this specification document are subject to Mini-Circuits standard limited warranty and terms and conditions (collectively, "Standard Terms"); Purchasers of this part are entitled to the rights and benefits contained therein. For a full statement of the Standard Terms and the exclusive rights and remedies thereunder, please visit Mini-Circuits' website at www.minicircuits.com/MCLStore/terms.jsp



Product Marking

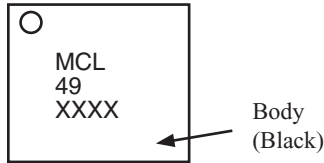

Markings in addition to model number designation may appear for internal quality control purposes.

Additional Detailed Technical Information

Additional information is available on our web site. To access this information enter the model number on our web site home page.

Performance data, graphs, s-parameter data set (.zip file)

Case Style: FG873

Plastic package, exposed paddle, lead finish: Matte-Tin

Tape & Reel: F68

7" Reels with 20, 50, 100, 200, 500, 1K devices

13" Reels with 2K, 3K, 4K devices

Suggested Layout for PCB Design: PL-252

Evaluation Board: TB-413-49+

Environmental Ratings: ENV08T2

Recommended Application Circuit

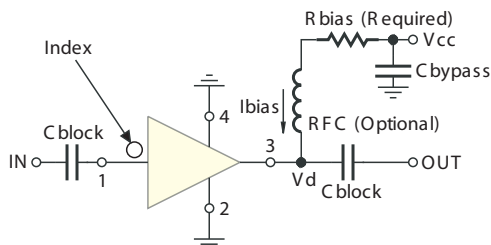

Test Board includes case, connectors, and components (in bold) soldered to PCB

R BIAS	
Vcc	"1%" Res. Values (ohms) for Optimum Biasing
7	34.8
8	48.7
9	63.4
10	78.7
11	95.3
12	110
13	127
14	140
15	158
16	174
17	191
18	205
19	221
20	232

Notes

- A. Performance and quality attributes and conditions not expressly stated in this specification document are intended to be excluded and do not form a part of this specification document.
- B. Electrical specifications and performance data contained in this specification document are based on Mini-Circuit's applicable established test performance criteria and measurement instructions.
- C. The parts covered by this specification document are subject to Mini-Circuits standard limited warranty and terms and conditions (collectively, "Standard Terms"); Purchasers of this part are entitled to the rights and benefits contained therein. For a full statement of the Standard Terms and the exclusive rights and remedies thereunder, please visit Mini-Circuits' website at www.minicircuits.com/MCLStore/terms.jsp



ESD Rating

Human Body Model (HBM): Class 1A (250v to < 500v) in accordance with ANSI/ESD STM 5.1 - 2001

Machine Model (MM): Class M1 (< 100v) in accordance with ANSI/ESD STM 5.2 - 1999

MSL Rating

Moisture Sensitivity: MSL1 in accordance with IPC/JEDECJ-STD-020C

No.	Test Required	Condition	Standard	Quantity
1	Visual Inspection	Low Power Microscope Magnification 40x	MIP-IN-0003 (MCT spec)	45 units
2	Electrical Test	Room Temperature	SCD (MCL spec)	45 units
3	SAM Analysis	Less than 10% growth in term of delamination	J-Std-020C (Jedec Standard)	45 units
4	Moisture Sensitivity Level 1	Bake at 125°C for 24 hours Soak at 85°C/85%RH for 168 hours Reflow 3 cycles at 260°C peak	J-Std-020C (Jedec Standard)	45 units

MSL Test Flow Chart



Notes

- A. Performance and quality attributes and conditions not expressly stated in this specification document are intended to be excluded and do not form a part of this specification document.
- B. Electrical specifications and performance data contained in this specification document are based on Mini-Circuit's applicable established test performance criteria and measurement instructions.
- C. The parts covered by this specification document are subject to Mini-Circuits standard limited warranty and terms and conditions (collectively, "Standard Terms"); Purchasers of this part are entitled to the rights and benefits contained therein. For a full statement of the Standard Terms and the exclusive rights and remedies thereunder, please visit Mini-Circuits' website at www.minicircuits.com/MCLStore/terms.jsp



Typical Performance Data

**NOTE: Use PDF Bookmarks to view DATA at required conditions
or to view GRAPHS.**

Definitions:

Input Return Loss = -S11 (dB)

Gain(Power Gain) = S21 (dB)

Reverse Isolation = -S12 (dB)

Output Return Loss = -S22 (dB)

TEST CONDITIONS: Icc = 65mA, Vd = 4.96V @Temperature = +25degC

FREQ	Gain	Isolation	Input Return Loss	Output Return Loss	Stability		FREQ	IP3 Output	1dB Comp. Output	Noise Figure
(MHz)	(dB)	(dB)	(dB)	(dB)	K	Delta	(MHz)	(dBm)	(dBm)	(dB)
50	14.01	18.42	11.07	14.85	1.09	0.65	50	33.51	16.96	4.73
100	13.98	18.43	11.02	14.87	1.09	0.65	100	33.47	17.24	4.92
200	13.96	18.45	11.06	14.87	1.10	0.65	200	33.52	16.92	4.48
400	13.95	18.49	11.15	14.88	1.10	0.64	300	33.59	16.90	4.89
600	13.94	18.49	11.22	14.81	1.10	0.64	400	33.06	17.20	4.67
800	13.97	18.50	11.35	14.75	1.10	0.64	500	32.93	17.09	4.97
1000	14.00	18.50	11.50	14.69	1.10	0.64	600	32.83	17.00	4.58
1200	14.04	18.50	11.71	14.58	1.10	0.65	700	33.00	17.15	4.95
1400	14.09	18.50	11.93	14.42	1.10	0.65	800	33.19	17.24	4.69
1600	14.15	18.49	12.20	14.24	1.10	0.65	900	33.12	17.16	4.87
1800	14.20	18.50	12.49	14.06	1.10	0.66	1000	32.84	17.28	4.72
2000	14.26	18.48	12.88	13.90	1.09	0.66	1100	32.59	16.94	4.81
2200	14.31	18.47	13.42	13.76	1.09	0.66	1200	32.41	16.67	4.80
2400	14.35	18.46	14.02	13.63	1.09	0.66	1300	32.13	16.75	4.79
2600	14.37	18.43	14.75	13.51	1.09	0.66	1400	31.72	16.72	4.89
2800	14.39	18.40	15.65	13.39	1.08	0.66	1500	31.49	16.73	4.99
3000	14.39	18.37	16.62	13.23	1.08	0.66	1600	31.82	16.68	4.96
3200	14.35	18.34	17.65	13.15	1.08	0.65	1700	32.22	16.76	4.73
3400	14.30	18.30	18.67	13.02	1.08	0.65	1800	31.79	16.58	4.85
3600	14.21	18.25	19.37	12.91	1.07	0.64	1900	31.23	16.64	4.67
3800	14.09	18.20	19.83	12.86	1.07	0.63	2000	30.88	16.70	4.93
4000	13.92	18.16	19.76	12.77	1.07	0.62	2100	30.44	16.61	4.76
4200	13.72	18.12	19.26	12.70	1.08	0.60	2200	30.07	16.55	4.93
4400	13.52	18.06	18.33	12.56	1.08	0.59	2300	29.75	16.57	4.77
4600	13.25	18.00	17.52	12.43	1.08	0.57	2400	29.31	16.32	5.07
4800	12.97	17.95	16.75	12.32	1.09	0.55	2500	28.83	16.18	4.80
5000	12.69	17.90	15.79	12.10	1.09	0.54	2600	28.58	15.99	5.10
5200	12.39	17.84	15.02	11.92	1.10	0.52	2700	28.33	15.81	4.90
5400	12.06	17.81	14.30	11.74	1.12	0.51	2800	28.13	15.55	5.09
5600	11.74	17.77	13.53	11.55	1.13	0.49	3000	27.54	15.09	5.08
6000	11.02	17.70	12.19	11.11	1.16	0.46	3200	26.73	14.60	5.09
6500	10.11	17.64	10.60	10.34	1.19	0.43	3400	26.12	14.17	5.13
7000	9.14	17.64	9.38	9.70	1.24	0.39	3600	25.36	13.67	5.14
7500	8.12	17.67	8.38	9.19	1.30	0.36	3800	24.75	13.13	5.24
8000	7.07	17.73	7.59	8.84	1.38	0.34	4000	24.18	12.60	5.28
9000	4.95	17.82	6.54	8.36	1.59	0.30	4200	23.53	12.16	5.34
10000	2.88	17.92	5.80	7.42	1.83	0.30	4400	22.99	11.69	5.31
11000	0.52	18.20	4.91	5.92	2.04	0.34	4600	22.49	11.43	5.55
12000	-2.17	18.95	3.88	4.48	2.24	0.40	4800	22.11	10.96	5.63
13000	-4.70	19.71	3.15	3.52	2.33	0.46	5000	21.76	10.49	5.77

REV. X1
LEE-49+
120124

Page 1 of 11



IF/RF MICROWAVE COMPONENTS • ISO 9001 ISO 14001 AS 9100 CERTIFIED • RoHS compliant

P.O. Box 350166, Brooklyn, New York 11235-0003 (718) 934-4500 Fax (718) 332-4661



The Design Engineers Search Engine finds the model you need, Instantly • For detailed performance specs & shopping online see



Typical Performance Data

Definitions:

Input Return Loss = -S11 (dB)

Gain(Power Gain) = S21 (dB)

Reverse Isolation = -S12 (dB)

Output Return Loss = -S22 (dB)

TEST CONDITIONS: Icc = 52mA, Vd = 4.87V @Temperature = +25degC

FREQ	Gain	Isolation	Input Return Loss	Output Return Loss	Stability		FREQ	IP3 Output	1dB Comp. Output	Noise Figure
					K	Delta				
(MHz)	(dB)	(dB)	(dB)	(dB)	K	Delta	(MHz)	(dBm)	(dBm)	(dB)
50	13.82	1.10	0.65	15.76	1.10	0.65	50	29.56	14.22	4.63
100	13.78	1.10	0.64	15.72	1.10	0.64	100	29.48	14.39	4.84
200	13.78	1.10	0.64	15.77	1.10	0.64	200	29.50	14.07	4.43
400	13.77	1.10	0.64	15.78	1.10	0.64	300	29.59	13.93	4.83
600	13.76	1.10	0.64	15.66	1.10	0.64	400	29.19	14.33	4.62
800	13.79	1.11	0.64	15.59	1.11	0.64	500	29.20	14.27	4.88
1000	13.81	1.10	0.64	15.45	1.10	0.64	600	29.12	14.20	4.48
1200	13.87	1.10	0.64	15.33	1.10	0.64	700	29.37	14.35	4.83
1400	13.92	1.10	0.64	15.13	1.10	0.64	800	29.59	14.28	4.59
1600	13.99	1.10	0.65	14.95	1.10	0.65	900	29.54	14.29	4.74
1800	14.04	1.10	0.65	14.70	1.10	0.65	1000	29.36	14.36	4.61
2000	14.11	1.09	0.66	14.50	1.09	0.66	1100	29.18	14.25	4.69
2200	14.17	1.09	0.66	14.34	1.09	0.66	1200	29.09	13.95	4.69
2400	14.20	1.09	0.66	14.15	1.09	0.66	1300	28.97	14.09	4.67
2600	14.23	1.09	0.66	14.01	1.09	0.66	1400	28.65	14.14	4.79
2800	14.25	1.08	0.66	13.87	1.08	0.66	1500	28.56	14.13	4.87
3000	14.25	1.08	0.66	13.68	1.08	0.66	1600	28.85	14.05	4.84
3200	14.22	1.08	0.65	13.61	1.08	0.65	1700	29.28	14.15	4.62
3400	14.16	1.07	0.65	13.46	1.07	0.65	1800	29.10	13.96	4.76
3600	14.07	1.07	0.64	13.33	1.07	0.64	1900	28.78	14.13	4.59
3800	13.95	1.07	0.63	13.32	1.07	0.63	2000	28.61	14.19	4.83
4000	13.78	1.07	0.61	13.24	1.07	0.61	2100	28.39	14.35	4.70
4200	13.58	1.07	0.60	13.20	1.07	0.60	2200	28.19	14.43	4.82
4400	13.36	1.08	0.58	13.09	1.08	0.58	2300	28.03	14.70	4.67
4600	13.09	1.08	0.57	12.95	1.08	0.57	2400	27.78	14.60	4.95
4800	12.80	1.09	0.55	12.87	1.09	0.55	2500	27.46	14.56	4.67
5000	12.53	1.10	0.53	12.66	1.10	0.53	2600	27.27	14.38	4.98
5200	12.22	1.11	0.52	12.50	1.11	0.52	2700	27.11	14.33	4.79
5400	11.89	1.12	0.50	12.35	1.12	0.50	2800	26.93	14.20	4.94
5600	11.56	1.14	0.48	12.16	1.14	0.48	3000	26.45	14.00	4.95
6000	10.83	1.17	0.45	11.69	1.17	0.45	3200	25.70	13.58	4.97
6500	9.93	1.21	0.41	10.96	1.21	0.41	3400	25.10	13.38	4.96
7000	8.96	1.26	0.38	10.29	1.26	0.38	3600	24.36	12.89	4.99
7500	7.95	1.33	0.35	9.73	1.33	0.35	3800	23.76	12.35	5.09
8000	6.90	1.41	0.32	9.38	1.41	0.32	4000	23.24	11.87	5.18
9000	4.82	1.62	0.29	8.79	1.62	0.29	4200	22.60	11.38	5.19
10000	2.76	1.86	0.29	7.74	1.86	0.29	4400	22.06	11.05	5.17
11000	0.43	2.09	0.32	6.13	2.09	0.32	4600	21.59	10.61	5.41
12000	-2.25	2.27	0.39	4.60	2.27	0.39	4800	21.24	10.09	5.47
13000	-4.81	2.37	0.45	3.57	2.37	0.45	5000	20.91	9.74	5.63

REV. X1
LEE-49+
120124



IF/RF MICROWAVE COMPONENTS • ISO 9001 ISO 14001 AS 9100 CERTIFIED • RoHS compliant
P.O. Box 350166, Brooklyn, New York 11235-0003 (718) 934-4500 Fax (718) 332-4661



The Design Engineers Search Engine finds the model you need, Instantly • For detailed performance specs & shopping online see



Typical Performance Data

Definitions:

Input Return Loss = -S11 (dB)

Gain(Power Gain) = S21 (dB)

Reverse Isolation = -S12 (dB)

Output Return Loss = -S22 (dB)

TEST CONDITIONS: Icc = 78mA, Vd = 5.04V @Temperature = +25degC

FREQ	Gain	Isolation	Input Return Loss	Output Return Loss	Stability		FREQ	IP3 Output	1dB Comp. Output	Noise Figure
					K	Delta				
(MHz)	(dB)	(dB)	(dB)	(dB)	K	Delta	(MHz)	(dBm)	(dBm)	(dB)
50	14.11	18.55	10.80	14.42	1.09	0.66	50	36.27	18.95	4.78
100	14.08	18.53	10.77	14.41	1.09	0.65	100	36.27	19.12	5.03
200	14.06	18.55	10.82	14.43	1.09	0.65	200	36.33	18.94	4.57
400	14.05	18.59	10.90	14.45	1.10	0.65	300	36.46	18.90	4.99
600	14.04	18.61	10.96	14.39	1.10	0.65	400	35.71	19.07	4.74
800	14.06	18.60	11.09	14.34	1.10	0.65	500	35.48	19.00	5.05
1000	14.09	18.61	11.23	14.27	1.10	0.65	600	35.30	18.91	4.66
1200	14.14	18.61	11.43	14.18	1.10	0.65	700	35.42	19.04	5.04
1400	14.18	18.60	11.63	14.05	1.10	0.65	800	35.55	19.01	4.78
1600	14.23	18.60	11.90	13.89	1.10	0.66	900	35.40	19.01	4.95
1800	14.28	18.60	12.18	13.74	1.09	0.66	1000	35.03	19.04	4.79
2000	14.34	18.57	12.56	13.59	1.09	0.66	1100	34.66	18.87	4.88
2200	14.39	18.57	13.07	13.47	1.09	0.66	1200	34.40	18.53	4.86
2400	14.42	18.55	13.62	13.36	1.09	0.67	1300	34.00	18.58	4.88
2600	14.46	18.53	14.33	13.25	1.09	0.67	1400	33.45	18.59	4.99
2800	14.47	18.50	15.18	13.14	1.08	0.66	1500	33.13	18.54	5.05
3000	14.46	18.47	16.11	12.99	1.08	0.66	1600	33.46	18.47	5.06
3200	14.43	18.44	17.15	12.92	1.08	0.66	1700	33.80	18.45	4.78
3400	14.37	18.39	18.17	12.79	1.08	0.65	1800	33.20	18.20	4.95
3600	14.28	18.34	18.99	12.67	1.07	0.64	1900	32.51	18.17	4.78
3800	14.17	18.30	19.63	12.61	1.07	0.63	2000	32.05	18.06	5.04
4000	14.01	18.25	19.76	12.52	1.07	0.62	2100	31.55	17.79	4.86
4200	13.81	18.21	19.42	12.43	1.08	0.60	2200	31.08	17.60	5.04
4400	13.60	18.15	18.61	12.31	1.08	0.59	2300	30.70	17.48	4.85
4600	13.35	18.08	17.84	12.15	1.08	0.57	2400	30.20	17.16	5.17
4800	13.06	18.03	17.06	12.02	1.09	0.56	2500	29.67	16.96	4.88
5000	12.79	17.96	16.09	11.80	1.09	0.54	2600	29.40	16.82	5.20
5200	12.49	17.91	15.28	11.61	1.10	0.53	2700	29.15	16.54	5.00
5400	12.16	17.87	14.54	11.44	1.11	0.51	2800	28.91	16.31	5.17
5600	11.85	17.83	13.75	11.22	1.12	0.49	3000	28.30	15.79	5.20
6000	11.13	17.75	12.36	10.76	1.15	0.47	3200	27.48	15.19	5.20
6500	10.22	17.68	10.71	10.02	1.18	0.43	3400	26.87	14.76	5.22
7000	9.25	17.66	9.47	9.40	1.23	0.40	3600	26.13	14.24	5.26
7500	8.23	17.69	8.44	8.90	1.29	0.37	3800	25.51	13.71	5.37
8000	7.16	17.73	7.63	8.57	1.36	0.35	4000	24.92	13.20	5.40
9000	5.04	17.81	6.57	8.12	1.57	0.31	4200	24.26	12.70	5.45
10000	2.95	17.91	5.81	7.23	1.80	0.31	4400	23.72	12.27	5.44
11000	0.58	18.20	4.92	5.80	2.02	0.34	4600	23.21	11.89	5.66
12000	-2.12	18.93	3.87	4.42	2.21	0.40	4800	22.82	11.43	5.76
13000	-4.64	19.69	3.15	3.49	2.31	0.46	5000	22.45	10.99	5.93

REV. X1
LEE-49+
120124

Page 3 of 11



IF/RF MICROWAVE COMPONENTS • ISO 9001 ISO 14001 AS 9100 CERTIFIED • RoHS compliant

P.O. Box 350166, Brooklyn, New York 11235-0003 (718) 934-4500 Fax (718) 332-4661



The Design Engineers Search Engine finds the model you need, Instantly • For detailed performance specs & shopping online see



Typical Performance Data

Definitions:

Input Return Loss = -S11 (dB)

Gain(Power Gain) = S21 (dB)

Reverse Isolation = -S12 (dB)

Output Return Loss = -S22 (dB)

TEST CONDITIONS: Icc = 65mA, Vd = 5.28V @Temperature = -45degC

FREQ	Gain	Isolation	Input Return Loss	Output Return Loss	Stability		FREQ	IP3 Output	1dB Comp. Output	Noise Figure
					K	Delta				
(MHz)	(dB)	(dB)	(dB)	(dB)	K	Delta	(MHz)	(dBm)	(dBm)	(dB)
50	14.10	18.52	10.65	14.19	1.09	0.66	50	33.97	16.67	4.01
100	14.09	18.54	10.80	14.44	1.09	0.65	100	33.88	16.91	4.24
200	14.09	18.54	10.99	14.69	1.09	0.65	200	33.93	16.59	3.81
400	14.03	18.60	10.57	13.93	1.10	0.65	300	34.13	16.59	4.19
600	14.04	18.59	10.64	13.95	1.10	0.65	400	33.61	16.94	3.95
800	14.06	18.59	10.77	13.93	1.10	0.65	500	33.54	16.82	4.26
1000	14.10	18.59	10.96	13.99	1.10	0.65	600	33.48	16.75	3.86
1200	14.13	18.59	11.05	13.85	1.09	0.66	700	33.72	16.91	4.22
1400	14.17	18.58	11.17	13.70	1.09	0.66	800	33.95	16.98	3.98
1600	14.22	18.57	11.37	13.52	1.09	0.66	900	33.91	16.86	4.14
1800	14.28	18.57	11.66	13.46	1.09	0.67	1000	33.66	16.97	3.99
2000	14.34	18.54	11.98	13.33	1.09	0.67	1100	33.47	16.74	4.05
2200	14.38	18.53	12.14	13.00	1.08	0.67	1200	33.33	16.40	4.05
2400	14.42	18.52	12.58	12.95	1.08	0.68	1300	33.19	16.57	4.05
2600	14.46	18.50	13.08	12.80	1.08	0.68	1400	32.80	16.56	4.17
2800	14.50	18.47	13.78	12.80	1.08	0.68	1500	32.64	16.59	4.23
3000	14.53	18.42	14.58	12.80	1.07	0.68	1600	32.88	16.54	4.21
3200	14.54	18.38	15.45	12.81	1.07	0.68	1700	33.45	16.58	3.95
3400	14.52	18.34	16.25	12.64	1.07	0.67	1800	33.22	16.43	4.11
3600	14.49	18.31	17.00	12.39	1.06	0.67	1900	32.71	16.56	3.91
3800	14.42	18.26	17.77	12.33	1.06	0.66	2000	32.48	16.69	4.20
4000	14.34	18.22	18.26	12.26	1.06	0.66	2100	32.12	16.71	3.97
4200	14.20	18.17	18.08	12.08	1.06	0.65	2200	31.81	16.83	4.20
4400	14.06	18.12	17.64	11.83	1.06	0.64	2300	31.57	16.95	4.00
4600	13.87	18.07	17.31	11.66	1.06	0.62	2400	31.18	16.84	4.33
4800	13.66	18.02	16.90	11.57	1.06	0.61	2500	30.66	16.76	4.01
5000	13.46	17.96	16.23	11.35	1.06	0.60	2600	30.43	16.69	4.35
5200	13.21	17.91	15.75	11.09	1.06	0.58	2700	30.18	16.50	4.12
5400	12.96	17.85	15.32	10.98	1.07	0.57	2800	30.00	16.36	4.33
5600	12.73	17.79	14.73	10.86	1.07	0.56	3000	29.53	15.97	4.32
6000	12.15	17.66	13.07	10.39	1.08	0.53	3200	28.75	15.62	4.34
6500	11.38	17.56	11.00	9.65	1.09	0.51	3400	28.16	15.25	4.34
7000	10.49	17.56	9.25	8.88	1.11	0.48	3600	27.39	14.78	4.33
7500	9.47	17.63	8.03	8.09	1.14	0.45	3800	26.72	14.27	4.41
8000	8.41	17.73	7.24	7.67	1.19	0.41	4000	26.15	13.80	4.49
9000	6.44	17.65	6.51	7.72	1.34	0.36	4200	25.52	13.31	4.53
10000	4.38	17.64	5.52	7.10	1.50	0.36	4400	24.98	12.93	4.49
11000	1.79	18.09	4.56	5.17	1.65	0.40	4600	24.40	12.59	4.68
12000	-0.97	18.85	3.65	4.04	1.78	0.44	4800	23.90	12.17	4.77
13000	-2.92	18.94	3.10	3.82	1.82	0.45	5000	23.46	11.72	4.92

REV. X1
LEE-49+
120124

Page 4 of 11



IF/RF MICROWAVE COMPONENTS • ISO 9001 ISO 14001 AS 9100 CERTIFIED • RoHS compliant

P.O. Box 350166, Brooklyn, New York 11235-0003 (718) 934-4500 Fax (718) 332-4661



The Design Engineers Search Engine finds the model you need, Instantly • For detailed performance specs & shopping online see



Typical Performance Data

Definitions:

Input Return Loss = -S11 (dB)

Gain(Power Gain) = S21 (dB)

Reverse Isolation = -S12 (dB)

Output Return Loss = -S22 (dB)

TEST CONDITIONS: Icc = 52mA, Vd = 5.18V @Temperature = -45degC

FREQ	Gain	Isolation	Input Return Loss	Output Return Loss	Stability		FREQ	IP3 Output	1dB Comp. Output	Noise Figure
					K	Delta				
(MHz)	(dB)	(dB)	(dB)	(dB)	K	Delta	(MHz)	(dBm)	(dBm)	(dB)
50	13.94	18.34	11.07	14.92	1.09	0.65	50	29.74	13.71	4.05
100	13.92	18.34	11.25	15.18	1.09	0.65	100	29.59	13.98	4.22
200	13.93	18.37	11.42	15.47	1.10	0.65	200	29.58	13.75	3.81
400	13.87	18.43	10.97	14.62	1.10	0.64	300	29.74	13.68	4.14
600	13.88	18.43	11.06	14.60	1.10	0.64	400	29.45	13.99	3.91
800	13.90	18.42	11.20	14.56	1.10	0.65	500	29.45	13.92	4.20
1000	13.94	18.42	11.40	14.64	1.10	0.65	600	29.41	13.90	3.82
1200	13.99	18.42	11.47	14.49	1.10	0.65	700	29.70	13.96	4.15
1400	14.03	18.41	11.64	14.28	1.09	0.65	800	29.91	13.95	3.93
1600	14.08	18.40	11.82	14.06	1.09	0.66	900	29.91	14.07	4.08
1800	14.13	18.40	12.17	13.98	1.09	0.66	1000	29.68	14.10	3.93
2000	14.21	18.38	12.48	13.85	1.09	0.67	1100	29.53	13.84	4.01
2200	14.25	18.38	12.64	13.46	1.09	0.67	1200	29.46	13.54	4.00
2400	14.30	18.36	13.15	13.38	1.08	0.67	1300	29.42	13.73	4.01
2600	14.35	18.34	13.66	13.22	1.08	0.67	1400	29.16	13.77	4.11
2800	14.39	18.30	14.39	13.21	1.08	0.68	1500	29.13	13.71	4.16
3000	14.42	18.26	15.27	13.19	1.07	0.68	1600	29.34	13.75	4.15
3200	14.43	18.23	16.12	13.20	1.07	0.67	1700	29.78	13.79	3.92
3400	14.41	18.19	16.97	13.00	1.07	0.67	1800	29.72	13.64	4.03
3600	14.38	18.14	17.69	12.76	1.06	0.67	1900	29.52	13.81	3.85
3800	14.32	18.10	18.32	12.71	1.06	0.66	2000	29.43	14.00	4.14
4000	14.22	18.07	18.66	12.63	1.06	0.65	2100	29.32	14.06	3.92
4200	14.08	18.03	18.25	12.49	1.06	0.64	2200	29.24	14.39	4.11
4400	13.94	17.97	17.64	12.23	1.05	0.63	2300	29.24	14.61	3.95
4600	13.74	17.93	17.16	12.07	1.05	0.62	2400	29.09	14.65	4.25
4800	13.53	17.88	16.65	12.00	1.06	0.61	2500	28.82	14.78	3.96
5000	13.32	17.82	15.91	11.79	1.06	0.59	2600	28.74	14.69	4.28
5200	13.08	17.79	15.43	11.55	1.06	0.58	2700	28.61	14.64	4.05
5400	12.82	17.73	14.99	11.44	1.07	0.56	2800	28.52	14.58	4.25
5600	12.58	17.67	14.39	11.33	1.07	0.55	3000	28.21	14.55	4.23
6000	11.99	17.57	12.80	10.91	1.09	0.53	3200	27.56	14.41	4.25
6500	11.21	17.49	10.81	10.16	1.10	0.50	3400	27.04	14.27	4.25
7000	10.32	17.50	9.13	9.39	1.12	0.47	3600	26.28	13.82	4.25
7500	9.31	17.58	7.95	8.58	1.15	0.44	3800	25.66	13.35	4.33
8000	8.24	17.69	7.19	8.10	1.21	0.40	4000	25.12	13.01	4.42
9000	6.29	17.64	6.47	8.15	1.36	0.34	4200	24.51	12.54	4.42
10000	4.25	17.64	5.50	7.45	1.53	0.34	4400	23.93	12.24	4.40
11000	1.70	18.09	4.56	5.38	1.68	0.38	4600	23.38	11.89	4.58
12000	-1.06	18.85	3.65	4.16	1.81	0.42	4800	22.92	11.45	4.67
13000	-3.02	18.94	3.09	3.89	1.84	0.44	5000	22.52	11.04	4.81

REV. X1
LEE-49+
120124

Page 5 of 11



IF/RF MICROWAVE COMPONENTS • ISO 9001 ISO 14001 AS 9100 CERTIFIED • RoHS compliant
P.O. Box 350166, Brooklyn, New York 11235-0003 (718) 934-4500 Fax (718) 332-4661



The Design Engineers Search Engine finds the model you need, Instantly • For detailed performance specs & shopping online see



Typical Performance Data

Definitions:

Input Return Loss = -S11 (dB)

Gain(Power Gain) = S21 (dB)

Reverse Isolation = -S12 (dB)

Output Return Loss = -S22 (dB)

TEST CONDITIONS: Icc = 78mA, Vd = 5.36V @Temperature = -45degC

FREQ	Gain	Isolation	Input Return Loss	Output Return Loss	Stability		FREQ	IP3 Output	1dB Comp. Output	Noise Figure
					K	Delta				
(MHz)	(dB)	(dB)	(dB)	(dB)	K	Delta	(MHz)	(dBm)	(dBm)	(dB)
50	14.19	18.64	10.43	13.82	1.09	0.66	50	37.01	18.87	4.07
100	14.18	18.62	10.57	14.06	1.09	0.66	100	36.97	19.05	4.29
200	14.18	18.62	10.77	14.31	1.09	0.66	200	37.00	18.74	3.88
400	14.12	18.69	10.36	13.59	1.09	0.65	300	37.18	18.71	4.25
600	14.13	18.70	10.43	13.61	1.09	0.65	400	36.50	19.01	4.01
800	14.15	18.69	10.55	13.58	1.09	0.66	500	36.33	19.00	4.31
1000	14.18	18.68	10.73	13.64	1.09	0.66	600	36.22	18.85	3.93
1200	14.21	18.68	10.80	13.52	1.09	0.66	700	36.44	19.01	4.27
1400	14.25	18.67	10.94	13.39	1.09	0.66	800	36.62	19.03	4.03
1600	14.30	18.67	11.13	13.22	1.09	0.67	900	36.59	18.97	4.20
1800	14.36	18.66	11.42	13.18	1.09	0.67	1000	36.26	19.05	4.03
2000	14.41	18.63	11.71	13.09	1.09	0.67	1100	35.97	18.80	4.15
2200	14.45	18.64	11.86	12.77	1.08	0.68	1200	35.76	18.44	4.13
2400	14.49	18.61	12.30	12.72	1.08	0.68	1300	35.47	18.56	4.13
2600	14.53	18.59	12.75	12.60	1.08	0.68	1400	34.89	18.55	4.23
2800	14.56	18.56	13.43	12.60	1.08	0.68	1500	34.63	18.54	4.28
3000	14.60	18.51	14.22	12.60	1.07	0.68	1600	34.93	18.51	4.29
3200	14.60	18.47	15.05	12.62	1.07	0.68	1700	35.51	18.52	4.03
3400	14.59	18.43	15.86	12.44	1.07	0.67	1800	35.08	18.33	4.20
3600	14.55	18.38	16.61	12.20	1.06	0.67	1900	34.39	18.36	3.98
3800	14.49	18.35	17.38	12.14	1.06	0.66	2000	34.01	18.43	4.28
4000	14.41	18.30	17.99	12.07	1.06	0.66	2100	33.53	18.34	4.02
4200	14.27	18.26	17.90	11.89	1.06	0.65	2200	33.11	18.26	4.28
4400	14.13	18.21	17.60	11.63	1.06	0.64	2300	32.74	18.21	4.07
4600	13.95	18.15	17.36	11.44	1.06	0.63	2400	32.25	17.98	4.40
4800	13.73	18.09	17.03	11.35	1.06	0.61	2500	31.65	17.82	4.10
5000	13.54	18.03	16.39	11.12	1.06	0.60	2600	31.38	17.67	4.43
5200	13.30	17.99	15.95	10.85	1.06	0.59	2700	31.11	17.43	4.17
5400	13.05	17.92	15.53	10.73	1.06	0.57	2800	30.88	17.22	4.41
5600	12.83	17.85	14.93	10.60	1.07	0.56	3000	30.37	16.74	4.42
6000	12.26	17.71	13.23	10.12	1.07	0.54	3200	29.55	16.26	4.41
6500	11.49	17.61	11.11	9.38	1.08	0.51	3400	28.97	15.87	4.42
7000	10.60	17.58	9.33	8.62	1.10	0.49	3600	28.21	15.40	4.41
7500	9.59	17.65	8.09	7.83	1.12	0.46	3800	27.54	14.92	4.49
8000	8.52	17.74	7.29	7.42	1.17	0.42	4000	26.94	14.38	4.59
9000	6.53	17.65	6.54	7.49	1.32	0.37	4200	26.29	13.97	4.62
10000	4.46	17.64	5.52	6.89	1.48	0.37	4400	25.76	13.58	4.59
11000	1.86	18.08	4.55	5.04	1.62	0.41	4600	25.19	13.18	4.78
12000	-0.90	18.84	3.65	3.97	1.76	0.44	4800	24.69	12.77	4.89
13000	-2.84	18.91	3.10	3.77	1.80	0.45	5000	24.24	12.28	5.05

REV. X1
LEE-49+
120124
Page 6 of 11



IF/RF MICROWAVE COMPONENTS • ISO 9001 ISO 14001 AS 9100 CERTIFIED • RoHS compliant
P.O. Box 350166, Brooklyn, New York 11235-0003 (718) 934-4500 Fax (718) 332-4661



The Design Engineers Search Engine finds the model you need, Instantly • For detailed performance specs & shopping online see



Typical Performance Data

Definitions:

Input Return Loss = -S11 (dB)

Gain(Power Gain) = S21 (dB)

Reverse Isolation = -S12 (dB)

Output Return Loss = -S22 (dB)

TEST CONDITIONS: Icc = 65mA, Vd = 4.70V @Temperature = +85degC

FREQ	Gain	Isolation	Input Return Loss	Output Return Loss	Stability		FREQ	IP3 Output	1dB Comp. Output	Noise Figure
					K	Delta				
(MHz)	(dB)	(dB)	(dB)	(dB)	K	Delta	(MHz)	(dBm)	(dBm)	(dB)
50	13.92	18.34	11.42	15.48	1.09	0.65	50	33.26	17.18	5.18
100	13.88	18.37	11.26	15.21	1.09	0.65	100	33.22	17.41	5.45
200	13.85	18.41	11.05	14.88	1.10	0.65	200	33.34	17.22	5.03
400	13.85	18.41	11.42	15.35	1.10	0.64	300	33.42	17.12	5.47
600	13.86	18.41	11.68	15.50	1.10	0.64	400	32.77	17.32	5.22
800	13.89	18.42	11.91	15.59	1.10	0.64	500	32.58	17.29	5.54
1000	13.94	18.41	12.26	15.67	1.10	0.64	600	32.44	17.16	5.14
1200	13.99	18.41	12.55	15.60	1.10	0.65	700	32.61	17.30	5.52
1400	14.04	18.41	12.84	15.41	1.10	0.65	800	32.71	17.33	5.25
1600	14.09	18.41	13.12	15.11	1.10	0.65	900	32.60	17.26	5.43
1800	14.14	18.41	13.44	14.77	1.10	0.66	1000	32.25	17.29	5.27
2000	14.20	18.41	13.82	14.42	1.09	0.66	1100	31.97	17.07	5.37
2200	14.23	18.40	14.43	14.19	1.09	0.66	1200	31.72	16.73	5.37
2400	14.25	18.38	15.18	13.97	1.09	0.66	1300	31.38	16.78	5.38
2600	14.26	18.37	16.08	13.79	1.09	0.66	1400	30.92	16.84	5.48
2800	14.23	18.35	17.19	13.66	1.08	0.66	1500	30.71	16.77	5.56
3000	14.19	18.31	18.46	13.50	1.08	0.66	1600	31.06	16.64	5.52
3200	14.11	18.29	19.80	13.49	1.08	0.65	1700	31.33	16.73	5.30
3400	14.01	18.24	20.99	13.46	1.08	0.65	1800	30.75	16.52	5.44
3600	13.86	18.18	21.38	13.44	1.07	0.64	1900	30.14	16.46	5.28
3800	13.68	18.14	21.16	13.46	1.07	0.63	2000	29.73	16.47	5.53
4000	13.46	18.10	20.42	13.45	1.07	0.62	2100	29.25	16.28	5.35
4200	13.20	18.04	19.47	13.43	1.08	0.60	2200	28.81	16.11	5.53
4400	12.92	17.99	18.32	13.30	1.08	0.59	2300	28.43	16.01	5.36
4600	12.60	17.93	17.32	13.11	1.08	0.57	2400	27.98	15.72	5.67
4800	12.27	17.88	16.42	12.99	1.09	0.55	2500	27.55	15.47	5.39
5000	11.93	17.83	15.32	12.71	1.09	0.54	2600	27.28	15.34	5.71
5200	11.57	17.79	14.40	12.46	1.10	0.52	2700	27.01	15.06	5.50
5400	11.18	17.78	13.58	12.24	1.12	0.51	2800	26.74	14.77	5.69
5600	10.79	17.77	12.77	12.00	1.13	0.49	3000	26.11	14.23	5.67
6000	10.00	17.72	11.56	11.46	1.16	0.46	3200	25.29	13.67	5.70
6500	9.01	17.70	10.34	10.75	1.19	0.43	3400	24.65	13.20	5.76
7000	8.03	17.69	9.57	10.22	1.24	0.39	3600	23.93	12.68	5.77
7500	7.01	17.68	8.76	9.90	1.30	0.36	3800	23.33	12.10	5.88
8000	5.99	17.70	7.95	9.86	1.38	0.34	4000	22.76	11.70	5.91
9000	3.87	17.85	6.76	8.97	1.59	0.30	4200	22.17	11.07	5.99
10000	1.58	18.27	5.86	7.11	1.83	0.30	4400	21.66	10.82	5.98
11000	-0.63	18.42	5.04	6.15	2.04	0.34	4600	21.25	10.43	6.22
12000	-2.82	18.80	4.16	5.07	2.24	0.40	4800	20.94	9.97	6.32
13000	-5.61	19.81	3.33	3.58	2.33	0.46	5000	20.61	9.55	6.47

REV. X1
LEE-49+
120124
Page 7 of 11



IF/RF MICROWAVE COMPONENTS • ISO 9001 ISO 14001 AS 9100 CERTIFIED • RoHS compliant
P.O. Box 350166, Brooklyn, New York 11235-0003 (718) 934-4500 Fax (718) 332-4661



The Design Engineers Search Engine finds the model you need, Instantly • For detailed performance specs & shopping online see



Typical Performance Data

Definitions:

Input Return Loss = -S11 (dB)

Gain(Power Gain) = S21 (dB)

Reverse Isolation = -S12 (dB)

Output Return Loss = -S22 (dB)

TEST CONDITIONS: Icc = 52mA, Vd = 4.61V @Temperature = +85degC

FREQ	Gain	Isolation	Input Return Loss	Output Return Loss	Stability		FREQ	IP3 Output	1dB Comp. Output	Noise Figure
					K	Delta				
(MHz)	(dB)	(dB)	(dB)	(dB)	K	Delta	(MHz)	(dBm)	(dBm)	(dB)
50	13.71	18.12	11.97	16.48	13.71	13.71	50	29.52	14.51	5.09
100	13.68	18.16	11.77	16.20	13.68	13.68	100	29.48	14.69	5.36
200	13.65	18.21	11.58	15.80	13.65	13.65	200	29.60	14.50	4.98
400	13.65	18.22	11.98	16.33	13.65	13.65	300	29.67	14.27	5.37
600	13.67	18.23	12.26	16.47	13.67	13.67	400	29.15	14.65	5.17
800	13.70	18.22	12.50	16.58	13.70	13.70	500	29.11	14.57	5.45
1000	13.75	18.22	12.84	16.62	13.75	13.75	600	28.97	14.56	5.09
1200	13.79	18.21	13.17	16.52	13.79	13.79	700	29.23	14.68	5.41
1400	13.86	18.22	13.52	16.26	13.86	13.86	800	29.39	14.66	5.19
1600	13.92	18.23	13.84	15.91	13.92	13.92	900	29.33	14.51	5.36
1800	13.98	18.24	14.20	15.48	13.98	13.98	1000	29.11	14.63	5.21
2000	14.03	18.21	14.60	15.08	14.03	14.03	1100	28.92	14.41	5.29
2200	14.07	18.21	15.30	14.82	14.07	14.07	1200	28.79	14.12	5.29
2400	14.09	18.21	16.12	14.54	14.09	14.09	1300	28.59	14.27	5.31
2600	14.10	18.18	17.07	14.33	14.10	14.10	1400	28.31	14.35	5.41
2800	14.08	18.16	18.29	14.19	14.08	14.08	1500	28.18	14.33	5.51
3000	14.05	18.13	19.58	14.01	14.05	14.05	1600	28.50	14.26	5.44
3200	13.96	18.10	20.77	14.00	13.96	13.96	1700	28.86	14.33	5.26
3400	13.86	18.06	21.54	13.97	13.86	13.86	1800	28.60	14.16	5.34
3600	13.70	18.01	21.32	13.95	13.70	13.70	1900	28.17	14.28	5.20
3800	13.51	17.96	20.62	14.00	13.51	13.51	2000	27.91	14.32	5.43
4000	13.30	17.93	19.59	13.99	13.30	13.30	2100	27.63	14.46	5.29
4200	13.02	17.89	18.63	14.00	13.02	13.02	2200	27.32	14.44	5.42
4400	12.75	17.84	17.51	13.90	12.75	12.75	2300	27.09	14.58	5.33
4600	12.42	17.78	16.66	13.73	12.42	12.42	2400	26.72	14.35	5.58
4800	12.07	17.74	15.84	13.62	12.07	12.07	2500	26.38	14.12	5.32
5000	11.75	17.70	14.82	13.34	11.75	11.75	2600	26.14	13.95	5.59
5200	11.37	17.66	14.00	13.10	11.37	11.37	2700	25.92	13.82	5.44
5400	10.99	17.66	13.21	12.89	10.99	10.99	2800	25.69	13.61	5.58
5600	10.60	17.66	12.47	12.67	10.60	10.60	3000	25.09	13.26	5.57
6000	9.80	17.63	11.35	12.09	9.80	9.80	3200	24.29	12.77	5.60
6500	8.83	17.64	10.18	11.35	8.83	8.83	3400	23.68	12.44	5.64
7000	7.84	17.63	9.45	10.78	7.84	7.84	3600	22.96	11.95	5.68
7500	6.84	17.64	8.68	10.42	6.84	6.84	3800	22.40	11.37	5.76
8000	5.83	17.68	7.89	10.38	5.83	5.83	4000	21.84	10.81	5.80
9000	3.74	17.84	6.73	9.40	3.74	3.74	4200	21.27	10.40	5.88
10000	1.48	18.28	5.86	7.37	1.48	1.48	4400	20.79	10.13	5.87
11000	-0.72	18.45	5.03	6.32	-0.72	-0.72	4600	20.38	9.60	6.10
12000	-2.90	18.82	4.15	5.16	-2.90	-2.90	4800	20.12	9.07	6.16
13000	-5.72	19.84	3.33	3.62	-5.72	-5.72	5000	19.85	8.70	6.31

REV. X1
LEE-49+
120124

Page 8 of 11



IF/RF MICROWAVE COMPONENTS • ISO 9001 ISO 14001 AS 9100 CERTIFIED • RoHS compliant
P.O. Box 350166, Brooklyn, New York 11235-0003 (718) 934-4500 Fax (718) 332-4661



The Design Engineers Search Engine finds the model you need, Instantly • For detailed performance specs & shopping online see



Typical Performance Data

Definitions:

Input Return Loss = -S11 (dB)

Gain(Power Gain) = S21 (dB)

Reverse Isolation = -S12 (dB)

Output Return Loss = -S22 (dB)

TEST CONDITIONS: Icc = 78mA, Vd = 4.78V @Temperature = +85degC

FREQ	Gain	Isolation	Input Return Loss	Output Return Loss	Stability		FREQ	IP3 Output	1dB Comp. Output	Noise Figure
					K	Delta				
(MHz)	(dB)	(dB)	(dB)	(dB)	K	Delta	(MHz)	(dBm)	(dBm)	(dB)
50	14.03	18.45	11.14	14.94	1.09	0.65	50	35.90	18.93	5.25
100	13.99	18.48	10.95	14.73	1.09	0.65	100	35.89	19.13	5.53
200	13.96	18.51	10.78	14.39	1.10	0.65	200	36.03	18.98	5.12
400	13.96	18.52	11.14	14.84	1.10	0.64	300	36.10	18.88	5.55
600	13.97	18.52	11.37	15.02	1.10	0.64	400	35.29	19.05	5.31
800	14.00	18.53	11.60	15.08	1.10	0.64	500	34.99	18.98	5.60
1000	14.04	18.52	11.93	15.19	1.10	0.64	600	34.74	18.86	5.21
1200	14.09	18.52	12.23	15.12	1.10	0.64	700	34.80	18.91	5.59
1400	14.14	18.51	12.48	14.98	1.10	0.65	800	34.83	18.95	5.34
1600	14.19	18.52	12.76	14.69	1.10	0.65	900	34.60	18.90	5.53
1800	14.23	18.52	13.04	14.40	1.10	0.65	1000	34.17	18.89	5.37
2000	14.29	18.51	13.44	14.08	1.09	0.66	1100	33.76	18.72	5.47
2200	14.32	18.51	14.01	13.87	1.09	0.66	1200	33.44	18.48	5.45
2400	14.33	18.49	14.69	13.68	1.09	0.66	1300	32.97	18.42	5.45
2600	14.34	18.48	15.58	13.51	1.09	0.65	1400	32.43	18.41	5.57
2800	14.32	18.45	16.65	13.39	1.09	0.65	1500	32.16	18.33	5.65
3000	14.28	18.41	17.85	13.25	1.09	0.64	1600	32.48	18.21	5.62
3200	14.20	18.38	19.23	13.23	1.09	0.63	1700	32.65	18.14	5.39
3400	14.10	18.33	20.55	13.22	1.09	0.62	1800	31.92	17.88	5.54
3600	13.95	18.29	21.27	13.19	1.09	0.61	1900	31.23	17.70	5.37
3800	13.77	18.24	21.36	13.19	1.09	0.60	2000	30.73	17.54	5.63
4000	13.56	18.19	20.84	13.17	1.09	0.58	2100	30.19	17.24	5.43
4200	13.29	18.14	19.92	13.14	1.10	0.56	2200	29.71	16.98	5.63
4400	13.02	18.08	18.77	13.00	1.11	0.55	2300	29.29	16.78	5.48
4600	12.71	18.01	17.74	12.81	1.12	0.53	2400	28.78	16.47	5.78
4800	12.37	17.96	16.76	12.65	1.13	0.51	2500	28.33	16.24	5.47
5000	12.04	17.90	15.63	12.39	1.14	0.50	2600	28.05	16.03	5.82
5200	11.67	17.86	14.64	12.10	1.15	0.48	2700	27.77	15.76	5.60
5400	11.29	17.83	13.79	11.90	1.17	0.46	2800	27.49	15.48	5.78
5600	10.90	17.82	12.96	11.65	1.19	0.44	3000	26.84	14.91	5.77
6000	10.11	17.77	11.70	11.13	1.24	0.41	3200	26.00	14.27	5.80
6500	9.11	17.74	10.44	10.42	1.29	0.37	3400	25.39	13.81	5.86
7000	8.13	17.71	9.64	9.92	1.36	0.34	3600	24.65	13.32	5.89
7500	7.11	17.69	8.82	9.61	1.45	0.31	3800	24.05	12.74	6.01
8000	6.08	17.71	7.99	9.58	1.55	0.29	4000	23.46	12.26	6.05
9000	3.94	17.85	6.78	8.74	1.82	0.28	4200	22.85	11.73	6.11
10000	1.64	18.27	5.87	6.97	2.12	0.29	4400	22.36	11.30	6.11
11000	-0.57	18.40	5.04	6.07	2.38	0.31	4600	21.93	10.97	6.35
12000	-2.77	18.78	4.16	5.01	2.57	0.36	4800	21.59	10.53	6.45
13000	-5.56	19.78	3.34	3.56	2.74	0.45	5000	21.25	10.07	6.59

REV. X1
LEE-49+
120124
Page 9 of 11



IF/RF MICROWAVE COMPONENTS • ISO 9001 ISO 14001 AS 9100 CERTIFIED • RoHS compliant
P.O. Box 350166, Brooklyn, New York 11235-0003 (718) 934-4500 Fax (718) 332-4661



The Design Engineers Search Engine finds the model you need, Instantly • For detailed performance specs & shopping online see



Typical Performance Curves

GAIN vs. TEMPERATURE

INPUT POWER = -15dBm, CURRENT = 65mA

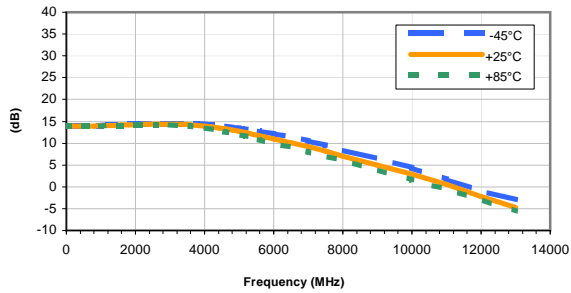

GAIN vs. CURRENT

INPUT POWER = -15dBm, Temperature = +25°C

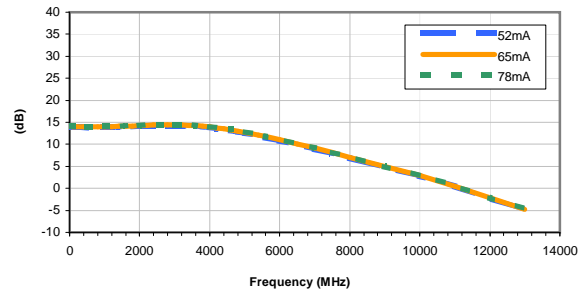

ISOLATION vs. TEMPERATURE

INPUT POWER = -15dBm, CURRENT = 65mA

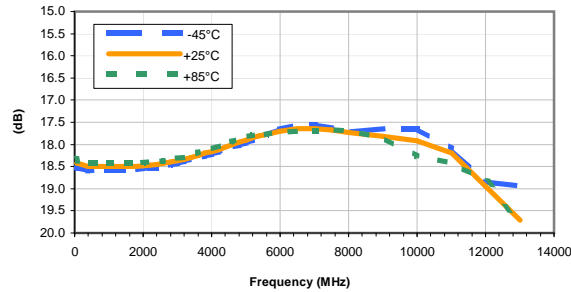

ISOLATION vs. CURRENT

INPUT POWER = -15dBm, Temperature = +25°C

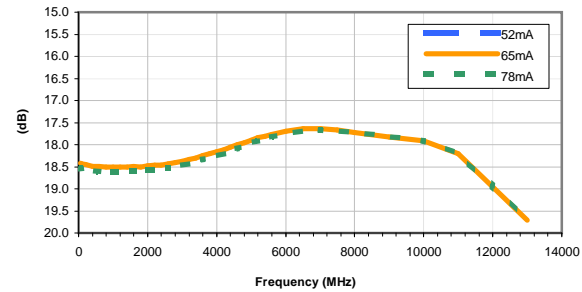

INPUT RETURN LOSS vs. TEMPERATURE

INPUT POWER = -15dBm, CURRENT = 65mA

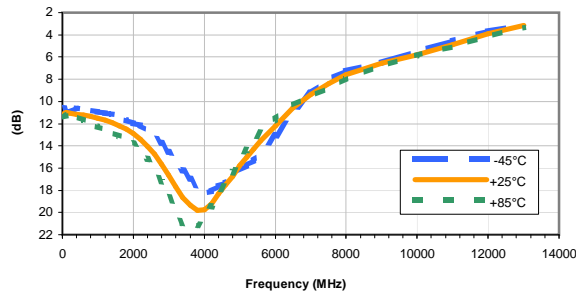

INPUT RETURN LOSS vs. CURRENT

INPUT POWER = -15dBm, Temperature = +25°C

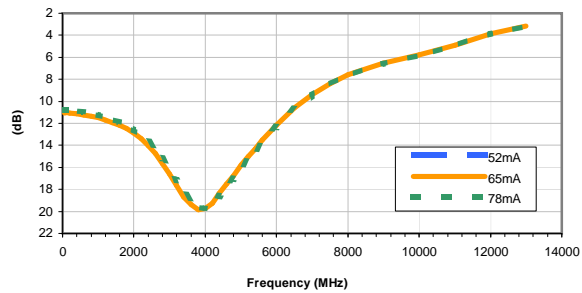

OUTPUT RETURN LOSS vs. TEMPERATURE

INPUT POWER = -15dBm, CURRENT = 65mA

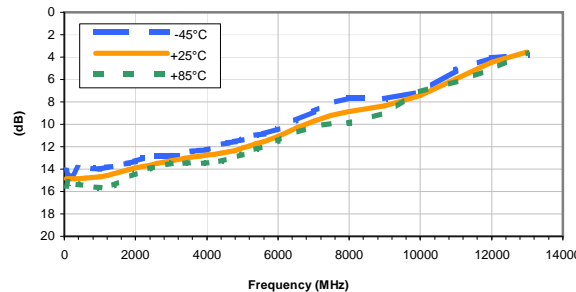

OUTPUT RETURN LOSS vs. CURRENT

INPUT POWER = -15dBm, Temperature = +25°C

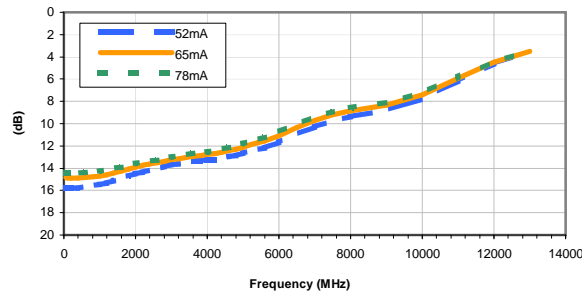

Typical Performance Curves

OUTPUT IP3 vs. TEMPERATURE

INPUT POWER = -15dBm, CURRENT = 65mA

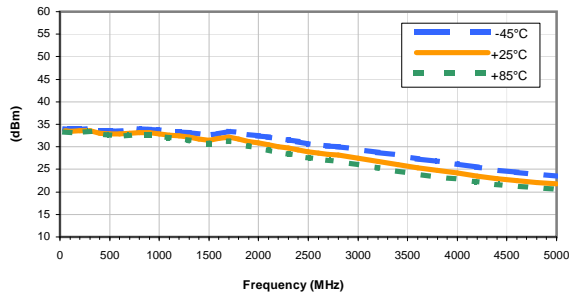

OUTPUT IP-3 vs. CURRENT

INPUT POWER = -15dBm, Temperature = +25°C

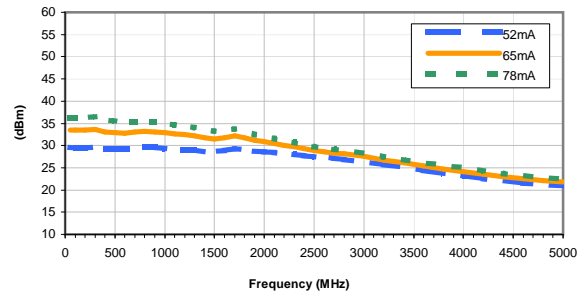

OUTPUT POWER at 1dB Compression vs. TEMPERATURE

CURRENT = 65mA

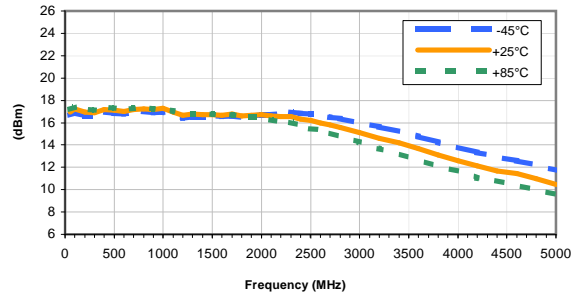

OUTPUT POWER at 1dB Compression vs. CURRENT

Temperature = +25°C

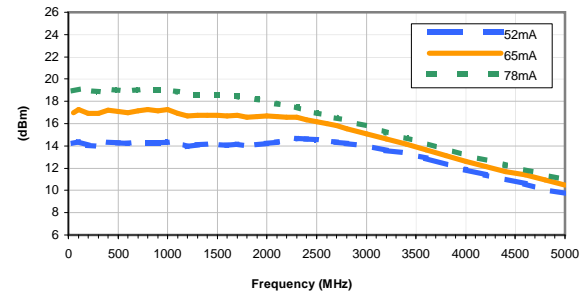

Noise Figure vs. TEMPERATURE

CURRENT = 65mA

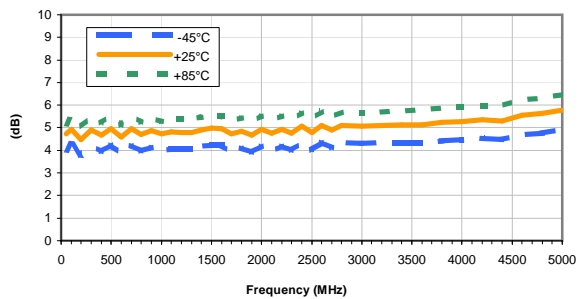

Noise Figure vs. CURRENT

Temperature = +25°C

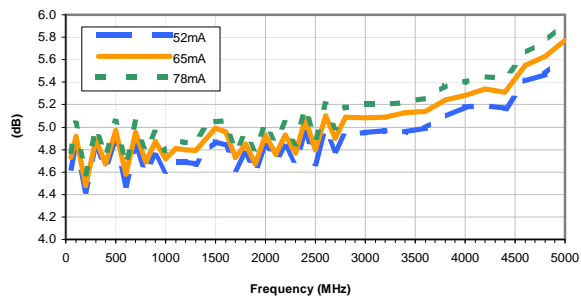

Typical Performance Curves

GAIN vs. TEMPERATURE

INPUT POWER = -15dBm, CURRENT = 65mA

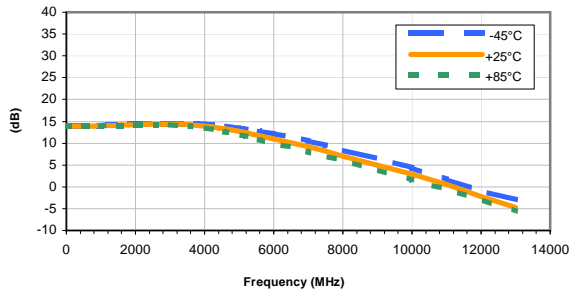

GAIN vs. CURRENT

INPUT POWER = -15dBm, Temperature = +25°C

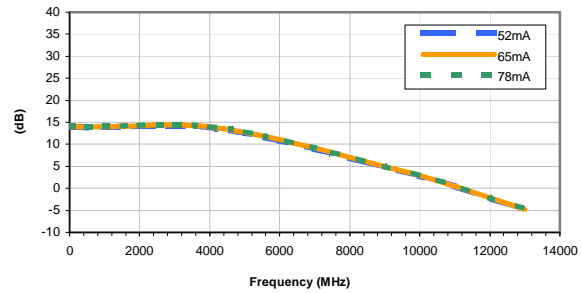

ISOLATION vs. TEMPERATURE

INPUT POWER = -15dBm, CURRENT = 65mA

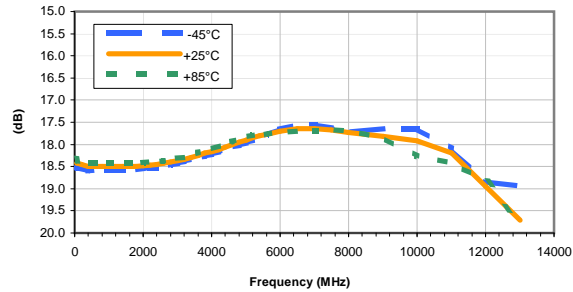

ISOLATION vs. CURRENT

INPUT POWER = -15dBm, Temperature = +25°C

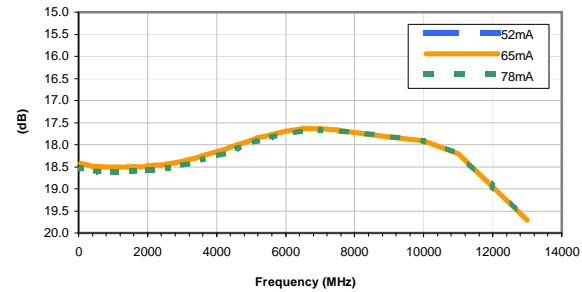

INPUT RETURN LOSS vs. TEMPERATURE

INPUT POWER = -15dBm, CURRENT = 65mA

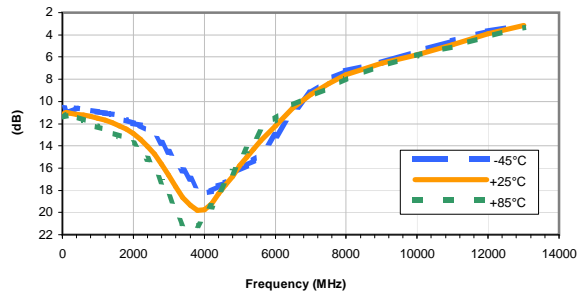

INPUT RETURN LOSS vs. CURRENT

INPUT POWER = -15dBm, Temperature = +25°C

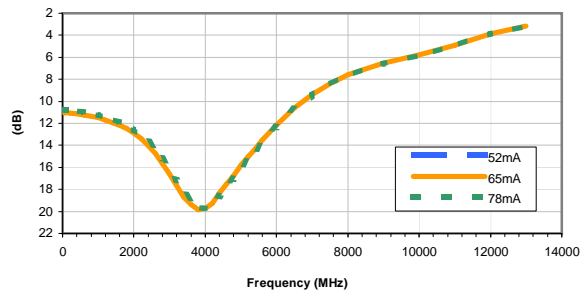

OUTPUT RETURN LOSS vs. TEMPERATURE

INPUT POWER = -15dBm, CURRENT = 65mA

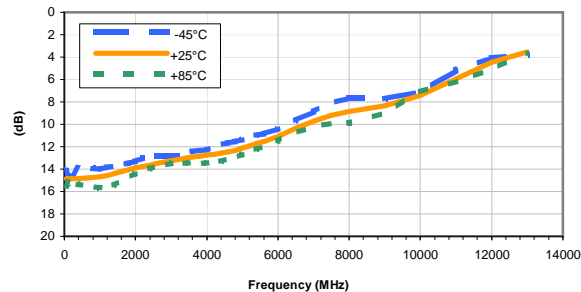

OUTPUT RETURN LOSS vs. CURRENT

INPUT POWER = -15dBm, Temperature = +25°C

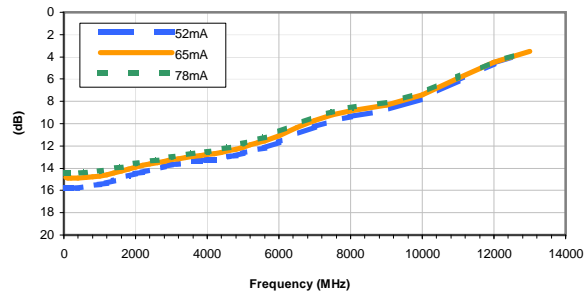

Typical Performance Curves

OUTPUT IP3 vs. TEMPERATURE

INPUT POWER = -15dBm, CURRENT = 65mA

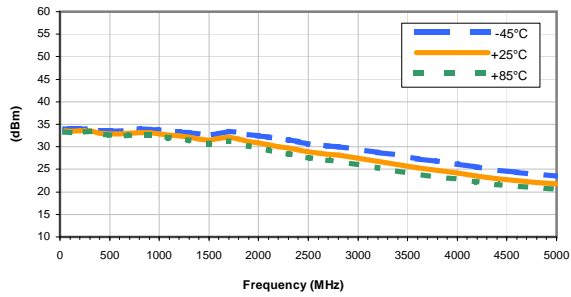

OUTPUT IP-3 vs. CURRENT

INPUT POWER = -15dBm, Temperature = +25°C

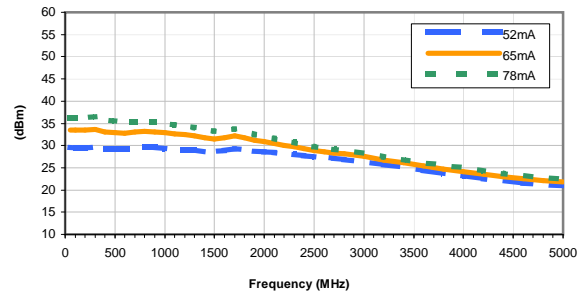

OUTPUT POWER at 1dB Compression vs. TEMPERATURE

CURRENT = 65mA

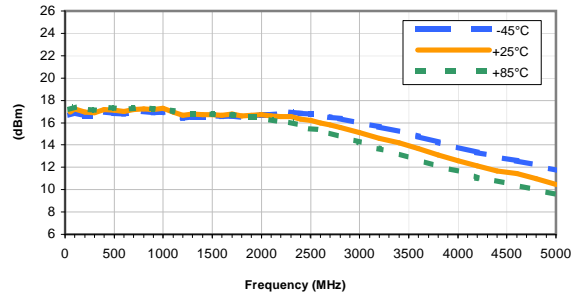

OUTPUT POWER at 1dB Compression vs. CURRENT

Temperature = +25°C

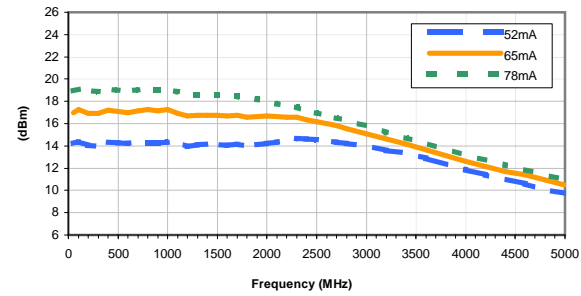

Noise Figure vs. TEMPERATURE

CURRENT = 65mA

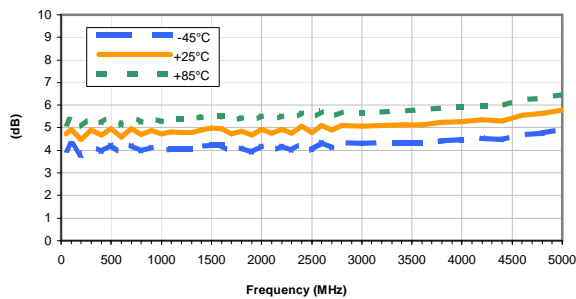

Noise Figure vs. CURRENT

Temperature = +25°C

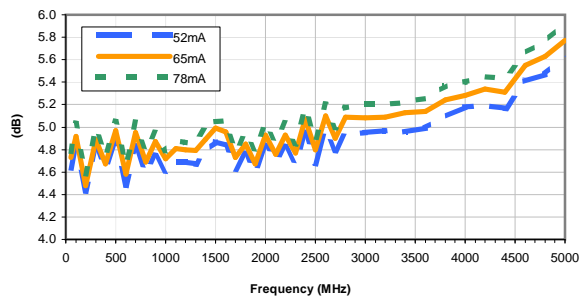

Outline Dimensions

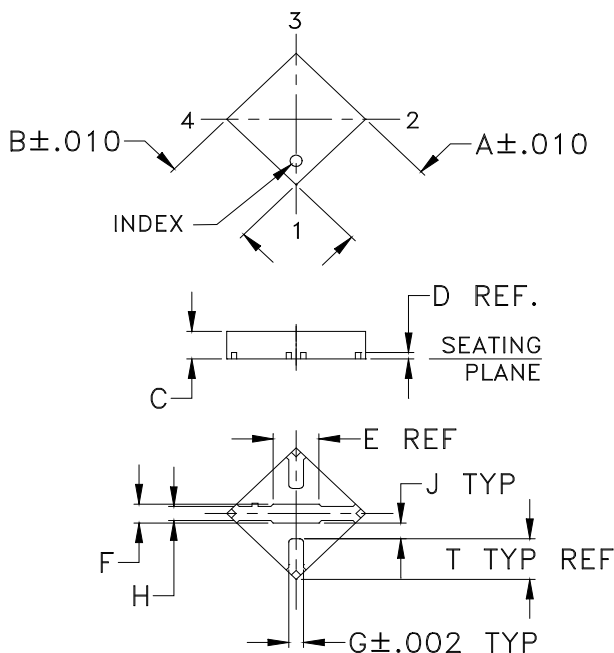

PCB Land Pattern

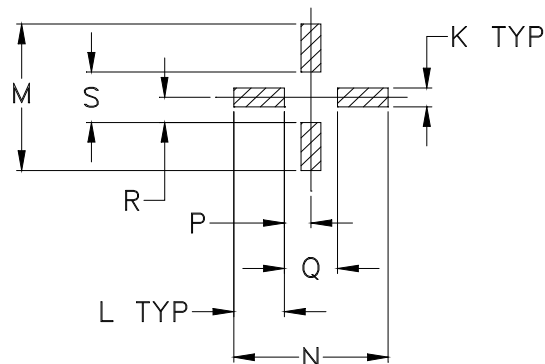

Suggested Layout,
Tolerance to be within $\pm .002$

CASE #	A	B	C	D	E	F	G	H	J	K	L	M	N	P
FG873	.118 (3.00)	.118 (3.00)	.035 (0.89)	.008 (0.20)	.07 (1.78)	.024 (0.60)	.017 (0.43)	.018 (0.46)	.021 (0.52)	.024 (0.61)	.061 (1.55)	.186 (4.72)	.186 (4.72)	.032 (0.81)

CASE #	Q	R	S	T	WT. GRAM
FG873	.064 (1.63)	.032 (0.81)	.064 (1.63)	.050 (1.27)	.02

Dimensions are in inches (mm). Tolerances: 2 Pl. $\pm .01$; 3Pl. $\pm .004$

Notes:

- Case material: Plastic.
- Termination finish:

For RoHS Case Styles: Tin-Silver alloy plate over Nickel barrier or Matte-Tin per Data Sheet.
All models, (+) suffix.

For RoHS-5 Case Styles: Tin-Lead plate. All models, no (+) suffix.



P.O. Box 350166, Brooklyn, New York 11235-0003 (718) 934-4500 Fax (718) 332-4661 For detailed performance specs & shopping online see Mini-Circuits web site



The Design Engineers Search Engine Provides ACTUAL Data Instantly From MINI-CIRCUITS At: www.minicircuits.com

RF/IF MICROWAVE COMPONENTS

Tape & Reel Packaging TR-F68

DEVICE ORIENTATION IN T&R

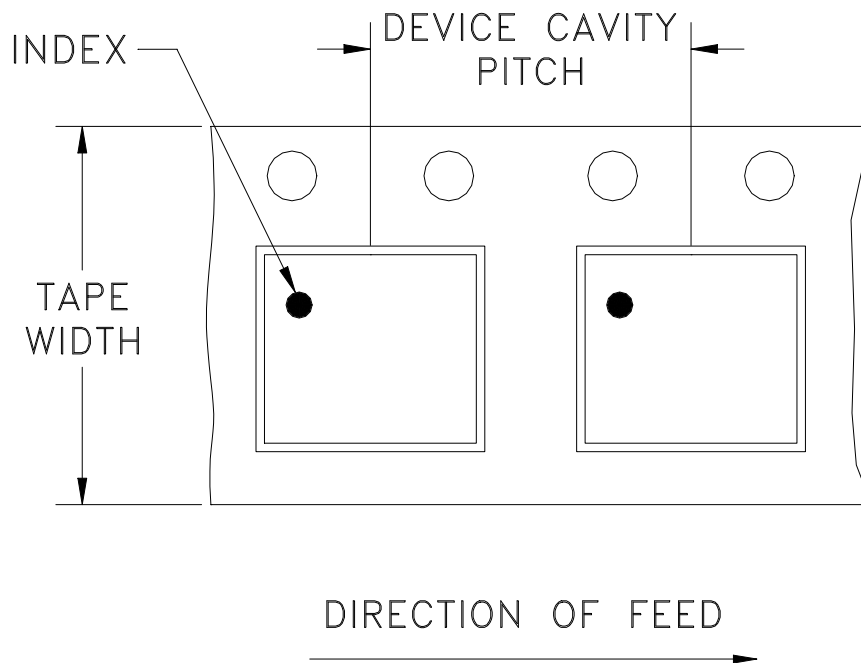

Tape Width, mm	Device Cavity Pitch, mm	Reel Size, inches	Devices per Reel see note	
12	8	7	Small quantity standard	20
				50
				100
				200
				500
		7	Standard	1000
		13	Standard	2000
				3000
4000				

Mini-Circuits carrier tape materials provide protection from ESD (Electro-Static Discharge) during handling and transportation. Tapes are static dissipative and comply with industry standards EIA-481/EIA-541.

Go to: www.minicircuits.com/pages/pdfs/tape.pdf



INTERNET <http://www.minicircuits.com>

P.O. Box 350166, Brooklyn, New York 11235-0003 (718) 934-4500 Fax (718) 332-4661

Distribution Centers NORTH AMERICA 800-654-7949 • 417-335-5935 • Fax 417-335-5945 • EUROPE 44-1252-832600 • Fax 44-1252-837010

Mini-Circuits ISO 9001 & ISO 14001 Certified

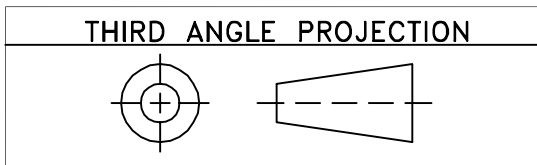

REVISIONS					
REV	ECN No.	DESCRIPTION	DATE	DR	AUTH
OR	M108436	NEW RELEASE	11/14/06	PW	IG

SUGGESTED MOUNTING CONFIGURATION
FOR FG873 CASE STYLE, "cb" PIN CONNECTION

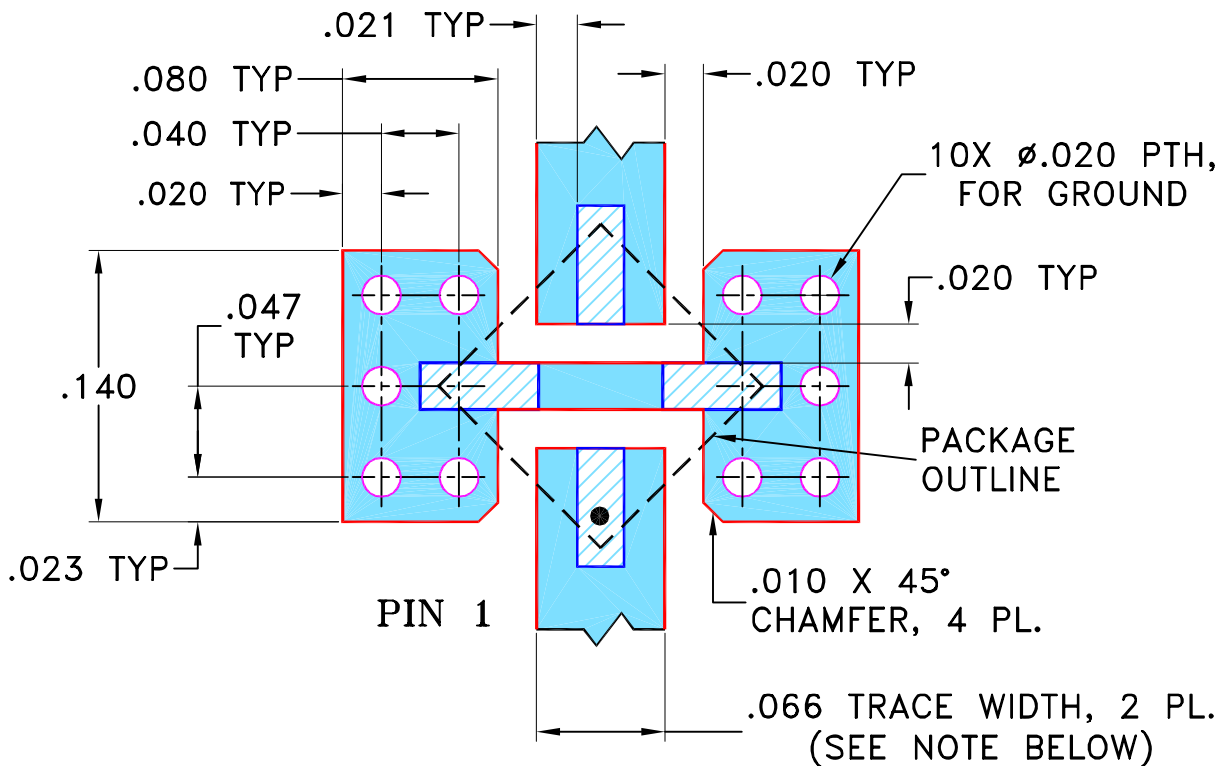

NOTES:

- TRACE WIDTH IS SHOWN FOR ROGERS R04350B WITH DIELECTRIC THICKNESS $.030" \pm .002"$; COPPER: 1/2 OZ. EACH SIDE. FOR OTHER MATERIALS TRACE WIDTH MAY NEED TO BE MODIFIED.
- BOTTOM SIDE OF THE PCB IS CONTINUOUS GROUND PLANE.



DENOTES PCB COPPER LAYOUT WITH SMOBC (SOLDER MASK OVER BARE COPPER)

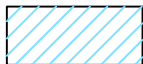

DENOTES COPPER LAND PATTERN FREE OF SOLDER MASK

UNLESS OTHERWISE SPECIFIED	INITIALS	DATE
DIMENSIONS ARE IN INCHES TOLERANCES ON: 2 PL DECIMALS \pm 3 PL DECIMALS \pm .005 ANGLES \pm FRACTIONS \pm	DRAWN	PW 11/11/06
	CHECKED	IL 11/14/06
	APPROVED	IG 11/14/06



Mini-Circuits®

13 Neptune Avenue
Brooklyn NY 11235

PL, cb, FG873, LEE, TB-413-XX+

SIZE A	CODE IDENT 15542	DRAWING NO: 98-PL-252	REV: OR
FILE: 98PL252	SCALE: 10:1	SHEET: 1 OF 1	

Mini-Circuits®
THIS DOCUMENT AND ITS CONTENTS ARE THE PROPERTY OF MINI-CIRCUITS. EXCEPT FOR USE EXPRESSLY GRANTED, IN WRITING, TO ITS VENDORS, VENDEE AND THE UNITED STATES GOVERNMENT, MINI-CIRCUITS RESERVES ALL PROPRIETARY DESIGN, USE, MANUFACTURING AND REPRODUCTION RIGHTS THERETO. THESE CONTENTS SHALL NOT BE USED, DUPLICATED OR DISCLOSED TO ANY OUTSIDE PARTY, IN WHOLE OR IN PART, WITHOUT WRITTEN PERMISSION OF MINI-CIRCUITS.

Evaluation Board and Circuit

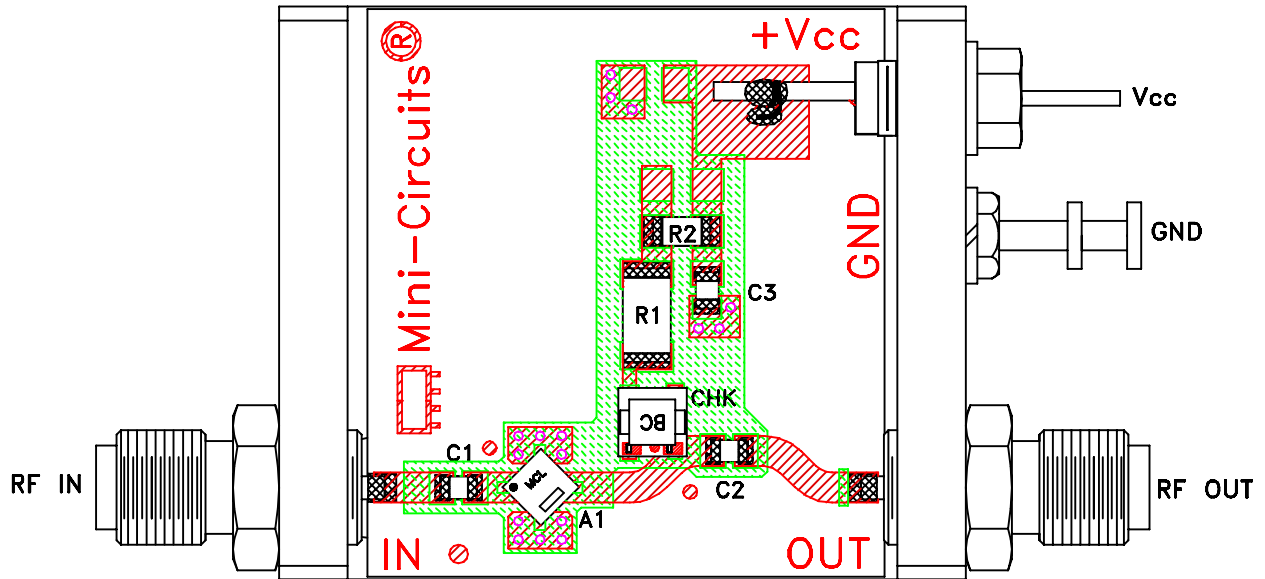

TB-413-49+

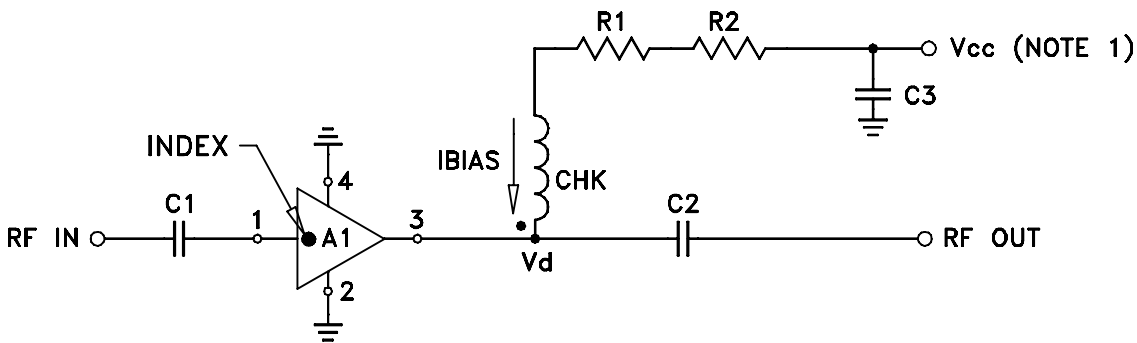

COMPONENT	VALUE
A1	LEE-49(+)
C1 (NOTE 4)	2400 pF
C2 (NOTE 4)	2400 pF
C3 (bypass)	0.1 uF
R1	110 Ohms, 0.75W
R2	0 Ohm, 0.25W
CHK	Mini-Circuits TCCH-80+

Schematic Diagram

NOTES:

1. Vcc voltage: $+12 \pm 0.2V$.
2. SMA Female connectors.
3. PCB material: Rogers R04350 or equivalent, dielectric constant=3.5, dielectric thickness=.030 inch.
4. Capacitors, C1 & C2 should be free of resonance up to the highest frequency specified.

 **Mini-Circuits®**

All Mini-Circuits products are manufactured under exacting quality assurance and control standards, and are capable of meeting published specifications after being subjected to any or all of the following physical and environmental test.

Specification	Test/Inspection Condition	Reference/Spec
Operating Temperature	-45° to 85°C or -40° to 85°C Ambient Environment	Individual Model Data Sheet
Storage Temperature	-65° to 150° C Ambient Environment	Individual Model Data Sheet
Thermal Shock	-55° to 100°C, 100 cycles	MIL-STD-202, Method 107, Condition A-3, except +100°C
Mechanical Shock	1.5Kg, 0.5 ms, 5 shock pulses, Y1 direction only	MIL-STD-883, Method 2002, Condition B, except Y1 direction only
Vibration (Variable Frequency)	50g peak	MIL-STD-883, Method 2007, Condition B
Autoclave	15 psig, 100% RH, 121°C, 96 hours	JESD22-A102, Condition C
HAST	130°C, 85% RH, 96 hours	JESD22-A110
Solderability	10X Magnification	J-STD-002, Para 4.2.5, Test S, 95% Coverage
Solder Reflow Heat	Sn-Pb Eutetic Process: 240°C peak Pb-Free Process: 260°C peak	J-STD-020, Table 4-1, 4-2 and 5-2; Figure 5-1
Moisture Sensitivity: Level 1	Bake at 125°C for 24 hours Soak at 85°C/85% RH for 168 hours, Reflow 3 cycles at 260°C peak	J-STD-020
Marking Resistance to Solvents	Isopropyl alcohol + mineral spirits at 25°C; terpene defluxer at 25°C; distilled water + proylene glycol monomethyl ether +	MIL-STD-202, Method 215



All Mini-Circuits products are manufactured under exacting quality assurance and control standards, and are capable of meeting published specifications after being subjected to any or all of the following physical and environmental test.

Specification	Test/Inspection Condition	Reference/Spec
	monoethanolamine at 63°C to 70°C	