

50Ω 0.7 to 2.4 GHz

The Big Deal

- Industry leading High IP3, 46 dBm typ.
- Integrated optimization circuits
- Linearity with low current consumption



Ceramic Package

 LTE Performance

Product Overview

The HXG-242+ (RoHS compliant) is an advanced amplifier module combining high dynamic range MMIC technology and optimization circuits to provide industry leading linearity over a focused frequency range. It is packaged in a Mini-Circuits System in Package (MSiP) module (6.4mm x 7.0mm x 2.4mm) using a sealed ceramic cover and having gold over Ni for excellent solderability.

Key Features

Feature	Advantages
Optimized Frequency Range	Covering primary wireless communications bands: Cellular, PCS, LTE
Extremely High IP3 vs. Current 46.6 dBm typ at 1500 MHz versus DC Power Consumption of 146mA	The HXG-242+ offers industry leading IP3 performance relative to device size and power consumption. The combination of the design and E-PHEMT provides enhanced linearity as evidence in the IP3. This feature makes this amplifier ideal for use in: <ul style="list-style-type: none"> • Driver amplifiers for complex waveform up converter paths • Drivers in linearized transmit systems • Secondary amplifiers in ultra High Dynamic range receivers
No External Matching Components Required	Unlike competing products, Mini-Circuits HXG-242+ provides Input and Output Return Loss of 10 dB up to 1.5 GHz without the need for any external matching components
Low Noise Figure: 2.4dB typ.	A unique feature of the HXG-242+ which separates this design from all competitors is the low noise figure performance in combination with the high dynamic range.

Notes

- A. Performance and quality attributes and conditions not expressly stated in this specification document are intended to be excluded and do not form a part of this specification document.
B. Electrical specifications and performance data contained in this specification document are based on Mini-Circuit's applicable established test performance criteria and measurement instructions.
C. The parts covered by this specification document are subject to Mini-Circuits standard limited warranty and terms and conditions (collectively, "Standard Terms"); Purchasers of this part are entitled to the rights and benefits contained therein. For a full statement of the Standard Terms and the exclusive rights and remedies thereunder, please visit Mini-Circuits' website at www.minicircuits.com/MCLStore/terms.jsp



Ultra High IP3 Amplifier Module 0.7-2.4 GHz

Product Features

- Ultra High IP3, +46 dBm typ. at 1.5 GHz
- Gain, 14.3 dB typ. at 2 GHz
- High Pout, P1dB +23 dBm typ.
- Low noise figure, 2.4 dB
- Internally matched for optimized IP3 performance
- No external matching components required

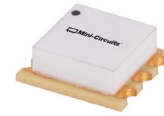

Generic photo used for illustration purposes only

HXG-242+

CASE STYLE: LZ1671

Typical Applications

- Base station infrastructure
- Portable Wireless
- LTE

+RoHS Compliant

The +Suffix identifies RoHS Compliance. See our web site for RoHS Compliance methodologies and qualifications

 LTE Performance

General Description

The HXG-242+ (RoHS compliant) is an advanced amplifier module in a Mini-Circuits System in Package (MSiP) which includes internal matching networks to offer extremely high dynamic range module. It is housed in a ceramic package 6.4mm x 7.0mm x 2.4mm.

simplified schematic and pin description

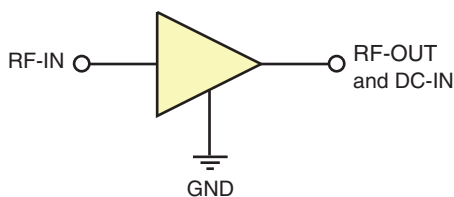

Function	Pin Number	Description
RF IN	2	RF input pin. This pin requires the use of an external DC blocking capacitor chosen for the frequency of operation.
RF-OUT and DC-IN	5	RF output and bias pin. DC voltage is present on this pin; therefore a DC blocking capacitor is necessary for proper operation. An RF choke is needed to feed DC bias without loss of RF signal due to the bias connection, as shown in "Recommended Application Circuit", Fig. 2
GND	1,3,4,6	Connections to ground. Use via holes as shown in "Suggested Layout for PCB Design" to reduce ground path inductance for best performance.

Notes

- A. Performance and quality attributes and conditions not expressly stated in this specification document are intended to be excluded and do not form a part of this specification document.
 B. Electrical specifications and performance data contained in this specification document are based on Mini-Circuit's applicable established test performance criteria and measurement instructions.
 C. The parts covered by this specification document are subject to Mini-Circuits standard limited warranty and terms and conditions (collectively, "Standard Terms"); Purchasers of this part are entitled to the rights and benefits contained therein. For a full statement of the Standard Terms and the exclusive rights and remedies thereunder, please visit Mini-Circuits' website at www.minicircuits.com/MCLStore/terms.jsp



Electrical Specifications⁽¹⁾ at 25°C and 5V, unless noted

Parameter	Condition (GHz)	Min.	Typ.	Max.	Units
Frequency Range		0.7		2.4	GHz
Gain	0.7	—	16.0	—	dB
	0.9	—	15.9	—	
	1.2	—	15.3	—	
	1.5	—	14.9	—	
	1.8	13.0	14.4	15.8	
	2.1	—	14.0	—	
Input Return Loss	0.7		17.5		dB
	0.9		15.8		
	1.2		13.7		
	1.5		11.6		
	1.8		9.7		
	2.1		7.8		
Output Return Loss	0.7		19.1		dB
	0.9		18.8		
	1.2		18.2		
	1.5		17.9		
	1.8		16.5		
	2.1		14.7		
Reverse Isolation	2.0		20.0		dB
Output Power @ 1 dB compression	0.7		22.2		dBm
	0.9		22.3		
	1.2		22.6		
	1.5		22.9		
	1.8		23.0		
	2.1		23.2		
Output IP3	0.7	—	41.3	—	dBm
	0.9	—	41.7	—	
	1.2	—	44.2	—	
	1.5	42.0	45.7	—	
	1.8	42.0	44.4	—	
	2.1	—	45.0	—	
Noise Figure	0.7		2.2		dB
	0.9		2.3		
	1.2		2.3		
	1.5		2.3		
	1.8		2.4		
	2.1		2.5		
Device Operating Voltage (V _o)		4.8	5.0	5.2	V
Device Operating Current		110	140	180	mA
Device Current Variation vs. Temperature ⁽²⁾			+14		μA/°C
Device Current Variation vs Voltage			0.05		mA/mV
Thermal Resistance, junction-to-ground lead			85		°C/W

⁽¹⁾ Measured on Mini-Circuits Characterization test board TB-640+. See Characterization Test Circuit (Fig.1)

⁽²⁾ Current at 85°C — Current at -45°C/130

Absolute Maximum Ratings

Parameter	Ratings
Operating Temperature (ground lead)	-40°C to 85°C
Storage Temperature	-65°C to 150°C
Operating Current at 5V	210 mA
Power Dissipation	1 W
Input Power (CW)	24 dBm
DC Voltage on Pin 3	6 V

Note:

Permanent damage may occur if any of these limits are exceeded.
Electrical maximum ratings are not intended for continuous normal operation.

Notes

- A. Performance and quality attributes and conditions not expressly stated in this specification document are intended to be excluded and do not form a part of this specification document.
- B. Electrical specifications and performance data contained in this specification document are based on Mini-Circuit's applicable established test performance criteria and measurement instructions.
- C. The parts covered by this specification document are subject to Mini-Circuits standard limited warranty and terms and conditions (collectively, "Standard Terms"); Purchasers of this part are entitled to the rights and benefits contained therein. For a full statement of the Standard Terms and the exclusive rights and remedies thereunder, please visit Mini-Circuits' website at www.minicircuits.com/MCLStore/terms.jsp

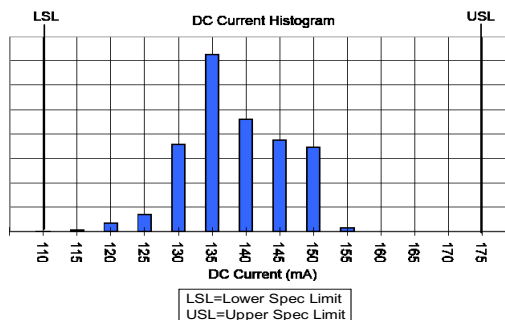

Characterization Test Circuit

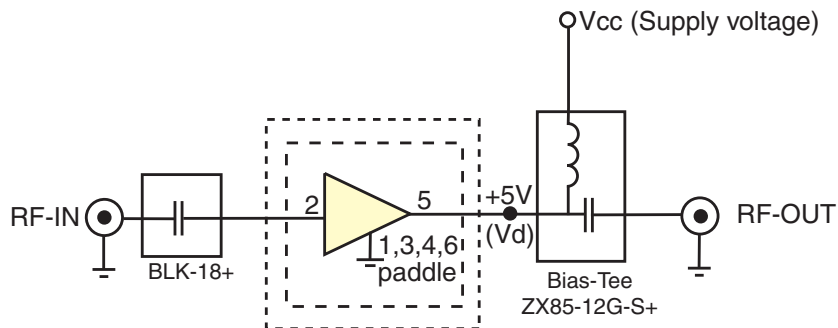

Fig 1. Block Diagram of Test Circuit used for characterization. (DUT soldered on Mini-Circuits Characterization test board TB-640+) Gain, Return loss, Output power at 1dB compression (P1 dB) , output IP3 (OIP3) and noise figure measured using Agilent’s N5242A PNA-X microwave network analyzer.

Conditions:

1. Gain and Return loss: Pin= -25dBm
2. Output IP3 (OIP3): Two tones, spaced 1 MHz apart, 5 dBm/tone at output.

Recommended Application Circuit

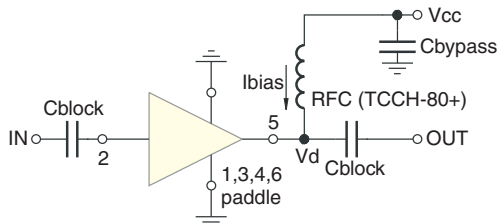
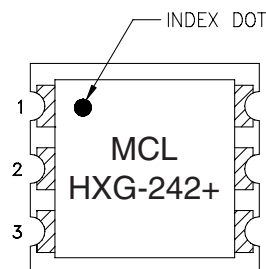

Fig 2. Test Board includes case, connectors, and components soldered to PCB

Product Marking



Markings in addition to model number designation may appear for internal quality control purposes.

Notes

- A. Performance and quality attributes and conditions not expressly stated in this specification document are intended to be excluded and do not form a part of this specification document.
- B. Electrical specifications and performance data contained in this specification document are based on Mini-Circuit’s applicable established test performance criteria and measurement instructions.
- C. The parts covered by this specification document are subject to Mini-Circuits standard limited warranty and terms and conditions (collectively, “Standard Terms”); Purchasers of this part are entitled to the rights and benefits contained therein. For a full statement of the Standard Terms and the exclusive rights and remedies thereunder, please visit Mini-Circuits’ website at www.minicircuits.com/MCLStore/terms.jsp



Additional Detailed Technical Information	
<i>additional information is available on our dash board. To access this information click here</i>	
Performance Data	Data Table
	Swept Graphs
	S-Parameter (S2P Files) Data Set (.zip file)
Case Style	LZ1671 <i>Ceramic package, exposed paddle, lead finish: gold plating over nickel</i>
Tape & Reel Standard quantities available on reel	F78 <i>7" reels with 20, 50, 100, 200 and 13" with 500, or 1K devices.</i>
Suggested Layout for PCB Design	PL-350
Evaluation Board	TB-641-242+
Environmental Ratings	ENV-59

ESD Rating

Human Body Model (HBM): Class 1A (250 to <500V) in accordance with ANSI/ESD STM 5.1-2001

Machine Model (MM): Class M1 (<100V) in accordance with ANSI/ESD STM 5.2-1999 passes 25V

Notes

- A. Performance and quality attributes and conditions not expressly stated in this specification document are intended to be excluded and do not form a part of this specification document.
 B. Electrical specifications and performance data contained in this specification document are based on Mini-Circuit's applicable established test performance criteria and measurement instructions.
 C. The parts covered by this specification document are subject to Mini-Circuits standard limited warranty and terms and conditions (collectively, "Standard Terms"); Purchasers of this part are entitled to the rights and benefits contained therein. For a full statement of the Standard Terms and the exclusive rights and remedies thereunder, please visit Mini-Circuits' website at www.minicircuits.com/MCLStore/terms.jsp



Typical Performance Data

NOTE: Use PDF Bookmarks to view DATA at required conditions

Definitions:

Input Return Loss = -S11 (dB)

Gain(Power Gain) = S21 (dB)

Reverse Isolation = -S12 (dB)

Output Return Loss = -S22 (dB)

TEST CONDITIONS: Vd = 5.00V, Id = 145.16mA @ Temperature = +25degC

FREQ	Gain	Isolation	Input Return Loss	Output Return Loss	Stability		IP-3 Output	1dB Comp. Output	Noise Figure
					K	Measure			
(MHz)	(dB)	(dB)	(dB)	(dB)			(dBm)	(dBm)	(dB)
500	16.33	20.73	18.07	18.73	1.12	0.66	41.42	22.87	1.89
600	16.18	20.70	18.27	18.17	1.13	0.67	41.36	22.81	1.99
700	16.10	20.63	17.34	17.08	1.12	0.67	40.74	22.74	1.95
800	15.97	20.57	16.84	16.20	1.13	0.68	43.11	22.97	2.06
900	15.83	20.50	16.37	16.08	1.13	0.69	41.52	22.82	2.05
1000	15.75	20.46	15.59	15.41	1.11	0.69	43.22	23.10	2.14
1050	15.66	20.46	15.75	14.97	1.13	0.70	43.58	23.05	2.15
1100	15.60	20.33	15.21	14.59	1.12	0.70	45.68	23.19	2.09
1150	15.57	20.30	14.64	14.29	1.13	0.71	43.97	23.17	2.18
1200	15.45	20.27	14.61	14.35	1.12	0.71	44.67	23.05	2.15
1250	15.45	20.25	14.11	13.84	1.12	0.71	44.67	23.07	2.17
1300	15.35	20.23	14.18	13.91	1.12	0.72	43.46	23.06	2.19
1350	15.25	20.21	13.99	13.78	1.12	0.72	45.57	23.16	2.18
1400	15.20	20.10	13.46	13.33	1.12	0.72	47.25	23.27	2.22
1450	15.12	20.02	13.14	13.32	1.12	0.73	46.61	23.42	2.26
1500	15.06	20.06	13.00	13.38	1.12	0.73	44.72	23.40	2.28
1550	15.03	19.95	12.65	13.05	1.11	0.73	45.54	23.24	2.26
1600	14.94	19.91	12.40	12.90	1.12	0.75	50.85	23.54	2.26
1650	14.82	19.91	12.13	12.74	1.11	0.75	47.38	23.58	2.31
1700	14.75	19.86	12.24	12.88	1.11	0.75	49.71	23.54	2.23
1750	14.67	19.79	11.87	12.69	1.11	0.76	45.40	23.48	2.15
1800	14.66	19.74	11.42	12.57	1.12	0.76	45.25	23.39	2.35
1850	14.65	19.67	11.14	12.49	1.11	0.76	46.27	23.71	2.29
1900	14.49	19.58	11.01	12.68	1.11	0.77	45.80	23.63	2.24
1950	14.40	19.57	10.90	12.63	1.11	0.78	46.10	23.74	2.49
2000	14.40	19.55	10.54	12.66	1.10	0.79	48.53	23.64	2.39
2050	14.25	19.50	10.57	12.81	1.09	0.79	48.46	23.59	2.35
2100	14.22	19.39	10.13	12.28	1.10	0.79	49.53	23.79	2.35
2150	14.11	19.39	9.95	12.68	1.10	0.81	49.03	23.73	2.37
2200	14.07	19.29	9.67	12.62	1.09	0.81	47.11	23.83	2.37
2250	14.01	19.20	9.47	12.38	1.08	0.81	46.55	23.83	2.42
2300	13.94	19.11	9.09	12.84	1.09	0.82	45.11	23.90	2.43
2350	13.89	19.15	8.91	12.85	1.08	0.82	46.73	23.99	2.29
2400	13.81	19.05	8.52	12.81	1.07	0.83	48.48	23.85	2.38
2500	13.71	18.94	8.16	12.87	1.06	0.84	47.08	23.90	2.53
2600	13.54	18.84	7.74	13.06	1.05	0.85	46.52	23.87	2.51
2700	13.44	18.74	7.21	13.46	1.02	0.86	46.21	23.88	2.63
2800	13.30	18.68	6.74	13.21	0.99	0.88	44.81	23.85	2.68
2900	13.19	18.48	6.27	13.57	0.97	0.89	47.87	23.70	2.68
3000	13.04	18.43	5.73	13.58	0.94	0.90	45.38	23.70	2.78

Typical Performance Data

Definitions:

Input Return Loss = -S11 (dB)

Gain(Power Gain) = S21 (dB)

Reverse Isolation = -S12 (dB)

Output Return Loss = -S22 (dB)

TEST CONDITIONS: Vd = 4.75V, Id = 133.07mA @ Temperature = +25degC

FREQ	Gain	Isolation	Input Return Loss	Output Return Loss	Stability		IP-3 Output	1dB Comp. Output	Noise Figure
					K	Measure			
(MHz)	(dB)	(dB)	(dB)	(dB)	K	Measure	(dBm)	(dBm)	(dB)
500	16.22	20.66	18.17	18.65	1.12	0.66	42.98	22.33	1.89
600	16.09	20.64	18.39	18.16	1.12	0.67	42.46	22.29	1.98
700	16.00	20.53	17.46	16.92	1.12	0.67	41.42	22.21	1.95
800	15.87	20.49	16.95	16.36	1.13	0.68	42.95	22.44	2.02
900	15.74	20.44	16.50	15.71	1.13	0.69	41.50	22.30	2.02
1000	15.66	20.38	15.66	15.06	1.12	0.69	43.06	22.55	2.09
1050	15.55	20.37	15.84	14.89	1.13	0.70	42.36	22.51	2.13
1100	15.49	20.24	15.28	14.67	1.12	0.70	42.40	22.65	2.07
1150	15.46	20.22	14.70	14.30	1.13	0.71	42.25	22.62	2.17
1200	15.36	20.17	14.70	14.25	1.12	0.71	42.30	22.52	2.17
1250	15.35	20.17	14.18	13.65	1.13	0.72	41.96	22.51	2.12
1300	15.25	20.13	14.24	13.77	1.12	0.72	41.55	22.51	2.15
1350	15.15	20.12	14.07	13.87	1.12	0.72	42.38	22.60	2.13
1400	15.11	20.00	13.53	13.38	1.12	0.72	42.56	22.71	2.17
1450	15.03	19.95	13.23	13.10	1.12	0.73	42.27	22.83	2.23
1500	14.96	19.95	13.07	13.07	1.12	0.74	41.51	22.82	2.30
1550	14.93	19.85	12.73	12.68	1.11	0.73	42.33	22.67	2.23
1600	14.85	19.83	12.49	12.92	1.12	0.74	43.50	22.94	2.30
1650	14.73	19.78	12.20	12.79	1.11	0.75	43.57	22.99	2.28
1700	14.65	19.77	12.33	12.83	1.11	0.75	42.80	22.96	2.19
1750	14.58	19.70	11.94	12.93	1.11	0.76	41.56	22.89	2.10
1800	14.56	19.61	11.50	12.59	1.12	0.77	42.01	22.83	2.31
1850	14.54	19.56	11.22	12.57	1.11	0.77	42.04	23.08	2.24
1900	14.41	19.48	11.08	12.56	1.11	0.77	42.34	23.02	2.23
1950	14.30	19.45	10.97	12.50	1.11	0.78	40.93	23.14	2.40
2000	14.30	19.44	10.61	12.58	1.10	0.79	43.01	23.04	2.35
2050	14.17	19.42	10.61	12.75	1.09	0.79	42.48	22.99	2.32
2100	14.14	19.26	10.18	12.56	1.10	0.79	42.32	23.17	2.34
2150	14.02	19.30	10.01	12.74	1.10	0.80	42.42	23.10	2.33
2200	13.98	19.17	9.74	12.64	1.09	0.80	42.81	23.21	2.33
2250	13.92	19.11	9.54	12.63	1.08	0.81	41.61	23.20	2.40
2300	13.84	19.00	9.15	12.66	1.09	0.82	41.55	23.26	2.38
2350	13.81	19.03	8.96	13.06	1.08	0.82	42.32	23.35	2.31
2400	13.72	18.94	8.58	12.92	1.07	0.83	42.37	23.21	2.31
2500	13.63	18.81	8.21	13.01	1.06	0.84	42.00	23.24	2.46
2600	13.46	18.70	7.78	13.37	1.05	0.85	42.14	23.26	2.53
2700	13.37	18.63	7.25	13.44	1.02	0.86	41.47	23.26	2.55
2800	13.22	18.55	6.77	13.55	0.99	0.88	41.72	23.21	2.64
2900	13.11	18.38	6.31	13.90	0.97	0.88	42.75	23.12	2.62
3000	12.97	18.32	5.75	13.96	0.94	0.90	42.58	23.08	2.74

Typical Performance Data

Definitions:

Input Return Loss = -S11 (dB)

Gain(Power Gain) = S21 (dB)

Reverse Isolation = -S12 (dB)

Output Return Loss = -S22 (dB)

TEST CONDITIONS: Vd = 5.25V, Id = 158.18mA @ Temperature = +25degC

FREQ	Gain	Isolation	Input Return Loss	Output Return Loss	Stability		IP-3 Output	1dB Comp. Output	Noise Figure
					K	Measure			
(MHz)	(dB)	(dB)	(dB)	(dB)	K	Measure	(dBm)	(dBm)	(dB)
500	16.40	20.81	17.95	18.60	1.12	0.66	40.77	23.33	1.98
600	16.26	20.78	18.14	18.65	1.13	0.67	41.41	23.28	2.03
700	16.18	20.72	17.27	17.11	1.12	0.67	40.69	23.22	1.97
800	16.04	20.64	16.74	16.60	1.13	0.68	42.05	23.46	2.07
900	15.92	20.57	16.31	15.93	1.13	0.69	41.21	23.30	2.08
1000	15.84	20.54	15.51	15.23	1.12	0.69	42.29	23.60	2.17
1050	15.73	20.58	15.68	15.41	1.13	0.70	43.09	23.53	2.17
1100	15.67	20.40	15.15	14.56	1.12	0.70	44.29	23.71	2.12
1150	15.64	20.39	14.56	14.53	1.13	0.71	44.40	23.67	2.19
1200	15.52	20.36	14.55	14.15	1.12	0.71	43.29	23.56	2.23
1250	15.53	20.34	14.05	14.04	1.13	0.72	44.27	23.58	2.18
1300	15.42	20.31	14.09	13.86	1.12	0.72	43.18	23.55	2.22
1350	15.32	20.29	13.93	13.90	1.12	0.72	44.14	23.69	2.19
1400	15.27	20.18	13.39	13.47	1.12	0.72	45.07	23.80	2.24
1450	15.19	20.09	13.08	13.28	1.11	0.73	47.90	23.95	2.29
1500	15.12	20.13	12.95	13.51	1.12	0.74	48.80	23.93	2.31
1550	15.11	20.03	12.61	12.93	1.11	0.73	44.36	23.75	2.31
1600	15.01	19.97	12.35	12.93	1.12	0.75	46.66	24.08	2.35
1650	14.89	19.93	12.08	12.82	1.11	0.74	45.93	24.11	2.35
1700	14.82	19.92	12.19	12.80	1.11	0.75	48.49	24.08	2.29
1750	14.76	19.87	11.80	12.85	1.11	0.76	45.58	24.00	2.17
1800	14.73	19.80	11.39	12.56	1.12	0.77	45.69	23.92	2.38
1850	14.71	19.73	11.10	12.28	1.11	0.77	47.63	24.25	2.32
1900	14.57	19.63	10.95	12.36	1.11	0.77	48.02	24.18	2.29
1950	14.47	19.62	10.86	12.54	1.11	0.78	50.45	24.28	2.48
2000	14.46	19.62	10.49	12.68	1.10	0.79	45.17	24.15	2.42
2050	14.32	19.60	10.50	12.67	1.10	0.79	46.30	24.11	2.39
2100	14.30	19.43	10.07	12.24	1.10	0.79	48.02	24.35	2.38
2150	14.18	19.47	9.92	12.74	1.10	0.80	46.74	24.27	2.36
2200	14.12	19.33	9.62	12.47	1.09	0.81	47.90	24.38	2.42
2250	14.08	19.26	9.43	12.47	1.08	0.81	48.59	24.39	2.46
2300	13.98	19.21	9.06	12.66	1.09	0.82	45.59	24.51	2.47
2350	13.96	19.21	8.87	12.72	1.08	0.82	46.98	24.56	2.32
2400	13.87	19.10	8.50	12.58	1.07	0.83	45.58	24.40	2.41
2500	13.77	19.01	8.13	12.88	1.06	0.84	45.52	24.46	2.54
2600	13.61	18.91	7.71	13.06	1.04	0.85	46.97	24.41	2.60
2700	13.49	18.79	7.19	13.18	1.02	0.86	43.56	24.43	2.68
2800	13.37	18.76	6.71	13.40	0.99	0.88	42.71	24.40	2.69
2900	13.24	18.56	6.25	13.37	0.97	0.88	43.27	24.23	2.71
3000	13.09	18.52	5.72	13.63	0.94	0.90	42.49	24.24	2.82

Typical Performance Data

Definitions:

Input Return Loss = -S11 (dB)

Gain(Power Gain) = S21 (dB)

Reverse Isolation = -S12 (dB)

Output Return Loss = -S22 (dB)

TEST CONDITIONS: Vd = 5.00V, Id = 146.26mA @ Temperature = -45degC

FREQ	Gain	Isolation	Input Return Loss	Output Return Loss	Stability		IP-3 Output	1dB Comp. Output	Noise Figure
					K	Measure			
(MHz)	(dB)	(dB)	(dB)	(dB)	K	Measure	(dBm)	(dBm)	(dB)
500	15.79	20.20	20.85	17.72	1.12	0.64	38.35	22.93	1.63
600	15.66	20.17	21.10	17.87	1.13	0.66	38.15	22.90	1.84
700	15.60	20.12	19.85	17.36	1.13	0.65	38.02	22.87	1.64
800	15.51	20.04	19.60	16.63	1.13	0.66	38.83	23.05	1.77
900	15.41	20.01	19.10	16.58	1.13	0.66	37.88	22.93	1.75
1000	15.34	19.98	18.09	16.22	1.13	0.67	39.50	23.13	1.83
1050	15.26	20.01	18.30	15.94	1.14	0.68	39.01	23.10	1.87
1100	15.22	19.89	17.64	15.31	1.13	0.67	40.32	23.21	1.78
1150	15.21	19.86	17.01	15.04	1.13	0.68	40.20	23.19	1.85
1200	15.11	19.87	17.06	15.16	1.13	0.69	39.89	23.09	1.90
1250	15.12	19.83	16.42	14.70	1.13	0.69	39.99	23.08	1.86
1300	15.03	19.81	16.57	14.83	1.13	0.69	39.41	23.11	1.90
1350	14.95	19.78	16.30	15.04	1.13	0.69	40.34	23.19	1.87
1400	14.91	19.67	15.64	14.72	1.13	0.70	40.59	23.29	1.92
1450	14.85	19.64	15.28	14.54	1.13	0.70	42.23	23.39	1.92
1500	14.80	19.67	15.08	14.45	1.13	0.71	41.26	23.39	1.99
1550	14.80	19.57	14.76	14.04	1.12	0.70	40.53	23.25	1.94
1600	14.72	19.54	14.47	13.98	1.13	0.72	42.03	23.52	1.96
1650	14.61	19.50	14.17	14.16	1.12	0.71	41.89	23.55	2.01
1700	14.56	19.49	14.31	14.15	1.12	0.72	42.55	23.53	1.91
1750	14.50	19.45	13.79	14.19	1.12	0.72	41.11	23.44	1.83
1800	14.49	19.39	13.23	14.04	1.13	0.73	41.19	23.38	2.03
1850	14.48	19.34	12.87	14.06	1.12	0.74	43.68	23.65	1.91
1900	14.35	19.23	12.72	13.97	1.12	0.74	43.66	23.59	1.96
1950	14.26	19.24	12.59	13.86	1.12	0.75	43.90	23.70	2.09
2000	14.28	19.27	12.11	14.04	1.12	0.76	42.57	23.64	2.01
2050	14.13	19.22	12.15	13.98	1.11	0.75	42.75	23.59	2.03
2100	14.14	19.13	11.63	13.87	1.11	0.76	43.29	23.78	1.99
2150	14.02	19.13	11.40	13.90	1.11	0.77	44.04	23.70	1.95
2200	13.99	18.99	11.07	14.10	1.10	0.77	42.77	23.81	2.03
2250	13.94	18.97	10.82	13.97	1.09	0.77	46.84	23.81	2.05
2300	13.85	18.87	10.36	13.92	1.10	0.78	46.89	23.82	2.02
2350	13.84	18.88	10.13	14.04	1.09	0.78	44.75	23.93	1.93
2400	13.75	18.82	9.67	13.98	1.08	0.79	43.67	23.84	1.99
2500	13.67	18.72	9.25	14.04	1.07	0.80	47.15	23.86	2.14
2600	13.51	18.66	8.74	14.34	1.06	0.80	45.48	23.91	2.17
2700	13.41	18.55	8.13	14.28	1.03	0.81	48.14	23.93	2.22
2800	13.30	18.53	7.53	14.01	1.00	0.83	47.96	23.93	2.26
2900	13.19	18.34	7.02	13.89	0.98	0.83	45.17	23.82	2.23
3000	13.04	18.30	6.41	13.72	0.95	0.84	45.33	23.72	2.38

*Typical Performance Data***Definitions:**

Input Return Loss = -S11 (dB)

Gain(Power Gain) = S21 (dB)

Reverse Isolation = -S12 (dB)

Output Return Loss = -S22 (dB)

TEST CONDITIONS: Vd = 4.75V, Id = 133.22mA @ Temperature = -45degC

FREQ	Gain	Isolation	Input Return Loss	Output Return Loss	Stability		IP-3 Output	1dB Comp. Output	Noise Figure
					K	Measure			
(MHz)	(dB)	(dB)	(dB)	(dB)	K	Measure	(dBm)	(dBm)	(dB)
500	15.68	20.12	20.88	17.80	1.12	0.64	38.62	22.36	1.56
600	15.56	20.11	21.14	17.83	1.13	0.65	38.43	22.32	1.75
700	15.49	20.02	19.93	17.15	1.13	0.65	38.21	22.28	1.67
800	15.40	19.97	19.67	16.85	1.13	0.67	38.99	22.44	1.74
900	15.30	19.93	19.15	16.14	1.13	0.66	38.50	22.35	1.74
1000	15.24	19.90	18.16	15.85	1.12	0.67	39.72	22.52	1.80
1050	15.16	19.92	18.38	15.67	1.14	0.68	39.70	22.52	1.85
1100	15.11	19.82	17.73	15.59	1.13	0.67	41.16	22.60	1.74
1150	15.10	19.74	17.10	15.10	1.13	0.68	40.74	22.57	1.84
1200	15.01	19.77	17.15	15.20	1.13	0.69	40.41	22.50	1.86
1250	15.01	19.76	16.47	14.88	1.13	0.69	40.32	22.49	1.85
1300	14.93	19.71	16.63	14.79	1.13	0.69	39.92	22.51	1.85
1350	14.86	19.70	16.38	14.99	1.13	0.69	40.34	22.57	1.83
1400	14.81	19.60	15.73	14.56	1.13	0.70	41.39	22.66	1.87
1450	14.75	19.55	15.38	14.34	1.13	0.70	42.91	22.75	1.93
1500	14.70	19.58	15.18	14.33	1.13	0.71	41.38	22.75	1.94
1550	14.70	19.50	14.85	14.18	1.12	0.71	40.52	22.64	1.91
1600	14.62	19.43	14.57	13.92	1.13	0.71	42.92	22.87	1.91
1650	14.52	19.43	14.24	14.20	1.12	0.72	42.19	22.91	1.94
1700	14.47	19.42	14.40	14.28	1.12	0.72	43.44	22.90	1.86
1750	14.41	19.36	13.86	14.00	1.12	0.72	40.64	22.84	1.79
1800	14.40	19.30	13.32	13.74	1.13	0.74	41.88	22.78	1.99
1850	14.38	19.27	12.94	13.82	1.12	0.74	43.53	23.00	1.93
1900	14.26	19.15	12.79	13.99	1.12	0.74	42.44	22.93	1.92
1950	14.18	19.16	12.64	13.99	1.12	0.74	42.36	23.03	2.10
2000	14.19	19.18	12.17	14.13	1.12	0.75	42.40	22.99	2.04
2050	14.05	19.14	12.20	14.13	1.11	0.76	42.17	22.95	1.95
2100	14.05	19.01	11.71	13.89	1.11	0.76	43.51	23.10	1.97
2150	13.94	19.06	11.48	14.11	1.11	0.77	43.09	23.04	1.95
2200	13.90	18.88	11.13	13.93	1.10	0.77	44.25	23.11	2.03
2250	13.86	18.84	10.87	13.82	1.10	0.77	44.50	23.10	2.05
2300	13.78	18.80	10.41	14.05	1.10	0.78	44.68	23.08	2.04
2350	13.75	18.83	10.18	14.26	1.09	0.78	44.45	23.20	1.87
2400	13.67	18.73	9.72	13.94	1.08	0.79	44.02	23.13	1.97
2500	13.59	18.65	9.29	13.89	1.07	0.80	44.48	23.13	2.11
2600	13.43	18.58	8.79	14.36	1.06	0.80	43.58	23.23	2.11
2700	13.33	18.49	8.17	14.51	1.03	0.82	48.21	23.20	2.20
2800	13.22	18.43	7.58	13.81	1.00	0.83	46.26	23.20	2.20
2900	13.12	18.26	7.05	14.00	0.98	0.83	47.39	23.14	2.17
3000	12.97	18.23	6.45	13.78	0.95	0.84	47.96	23.06	2.28

Typical Performance Data

Definitions:

Input Return Loss = -S11 (dB)

Gain(Power Gain) = S21 (dB)

Reverse Isolation = -S12 (dB)

Output Return Loss = -S22 (dB)

TEST CONDITIONS: Vd = 5.25V, Id = 160.75mA @ Temperature = -45degC

FREQ	Gain	Isolation	Input Return Loss	Output Return Loss	Stability		IP-3 Output	1dB Comp. Output	Noise Figure
					K	Measure			
(MHz)	(dB)	(dB)	(dB)	(dB)	K	Measure	(dBm)	(dBm)	(dB)
500	15.86	20.27	20.84	17.97	1.12	0.64	37.90	23.50	1.65
600	15.74	20.22	21.07	17.89	1.13	0.65	37.78	23.46	1.81
700	15.69	20.18	19.81	17.38	1.13	0.65	37.63	23.41	1.69
800	15.58	20.12	19.55	16.97	1.13	0.66	38.55	23.60	1.76
900	15.48	20.06	19.04	16.36	1.13	0.66	37.92	23.48	1.79
1000	15.42	20.04	18.03	15.81	1.12	0.67	39.18	23.72	1.84
1050	15.34	20.05	18.25	15.78	1.14	0.67	38.62	23.67	1.86
1100	15.29	19.93	17.58	15.68	1.13	0.67	39.63	23.79	1.82
1150	15.28	19.92	16.97	15.32	1.13	0.68	39.93	23.76	1.90
1200	15.17	19.90	17.03	15.00	1.13	0.68	39.46	23.67	1.91
1250	15.19	19.89	16.37	14.86	1.13	0.69	39.96	23.66	1.91
1300	15.10	19.83	16.53	14.81	1.13	0.69	38.98	23.69	1.92
1350	15.02	19.82	16.26	14.93	1.13	0.69	39.80	23.76	1.86
1400	14.98	19.76	15.61	14.62	1.13	0.70	39.95	23.86	1.93
1450	14.91	19.72	15.26	14.30	1.13	0.70	40.80	23.97	1.97
1500	14.86	19.73	15.04	14.52	1.13	0.71	40.80	23.97	2.02
1550	14.86	19.64	14.72	14.15	1.12	0.71	39.97	23.81	1.94
1600	14.78	19.61	14.44	13.98	1.13	0.72	41.17	24.12	2.00
1650	14.68	19.57	14.11	14.19	1.12	0.72	40.96	24.15	1.99
1700	14.63	19.54	14.27	14.21	1.12	0.72	41.82	24.15	1.91
1750	14.57	19.49	13.75	14.17	1.12	0.72	40.63	24.08	1.85
1800	14.56	19.46	13.20	14.02	1.13	0.73	40.71	24.00	2.05
1850	14.54	19.43	12.82	13.87	1.12	0.74	42.51	24.27	1.97
1900	14.42	19.28	12.69	13.87	1.12	0.74	43.47	24.19	1.91
1950	14.33	19.31	12.55	14.27	1.12	0.75	42.42	24.32	2.10
2000	14.34	19.28	12.07	13.89	1.11	0.75	40.86	24.26	2.06
2050	14.20	19.26	12.12	14.01	1.11	0.75	41.64	24.21	2.02
2100	14.20	19.14	11.61	13.59	1.11	0.76	42.20	24.42	1.98
2150	14.07	19.14	11.39	13.87	1.11	0.77	42.85	24.35	2.00
2200	14.05	19.04	11.05	13.89	1.10	0.77	42.44	24.48	2.03
2250	14.00	19.00	10.78	13.99	1.09	0.77	43.78	24.47	2.11
2300	13.92	18.89	10.34	14.00	1.10	0.78	46.50	24.53	2.12
2350	13.89	18.95	10.11	14.14	1.09	0.78	43.48	24.64	1.93
2400	13.81	18.86	9.66	13.89	1.08	0.79	43.59	24.51	2.01
2500	13.73	18.78	9.24	14.04	1.07	0.80	44.75	24.54	2.17
2600	13.57	18.73	8.73	14.22	1.05	0.80	43.23	24.58	2.21
2700	13.47	18.59	8.11	14.07	1.03	0.82	44.07	24.58	2.25
2800	13.35	18.58	7.51	13.92	1.00	0.83	43.51	24.58	2.33
2900	13.25	18.40	7.01	13.93	0.98	0.83	43.13	24.46	2.29
3000	13.10	18.35	6.41	13.76	0.95	0.84	43.64	24.43	2.36

Typical Performance Data

Definitions:

Input Return Loss = -S11 (dB)

Gain(Power Gain) = S21 (dB)

Reverse Isolation = -S12 (dB)

Output Return Loss = -S22 (dB)

TEST CONDITIONS: Vd = 5.00V, Id = 148.00mA @ Temperature = +85degC

FREQ	Gain	Isolation	Input Return Loss	Output Return Loss	Stability		IP-3 Output	1dB Comp. Output	Noise Figure
					K	Measure			
(MHz)	(dB)	(dB)	(dB)	(dB)	K	Measure	(dBm)	(dBm)	(dB)
500	16.62	21.12	15.64	17.96	1.11	0.67	46.22	22.79	2.22
600	16.46	21.07	15.82	17.40	1.12	0.68	45.94	22.73	2.31
700	16.37	20.96	15.19	16.31	1.11	0.68	43.86	22.68	2.22
800	16.21	20.92	14.68	15.59	1.12	0.70	46.59	22.94	2.30
900	16.05	20.84	14.29	14.92	1.12	0.70	44.91	22.76	2.34
1000	15.96	20.78	13.69	14.28	1.11	0.71	48.42	23.10	2.45
1050	15.85	20.79	13.84	14.28	1.12	0.72	49.23	23.01	2.43
1100	15.79	20.66	13.41	13.98	1.11	0.72	47.27	23.20	2.37
1150	15.73	20.60	12.93	13.56	1.12	0.73	49.20	23.18	2.46
1200	15.62	20.58	12.91	13.22	1.11	0.73	54.87	23.05	2.49
1250	15.60	20.52	12.51	13.18	1.11	0.74	46.84	23.05	2.48
1300	15.49	20.51	12.53	12.84	1.11	0.74	48.40	23.05	2.49
1350	15.38	20.45	12.42	12.91	1.11	0.74	49.55	23.17	2.46
1400	15.33	20.34	11.98	12.58	1.11	0.75	48.66	23.28	2.50
1450	15.24	20.28	11.75	12.37	1.11	0.75	46.02	23.43	2.59
1500	15.17	20.28	11.65	12.49	1.10	0.75	45.82	23.42	2.62
1550	15.13	20.17	11.35	12.14	1.10	0.76	51.93	23.23	2.57
1600	15.02	20.11	11.14	12.04	1.11	0.77	45.95	23.56	2.59
1650	14.89	20.08	10.92	11.84	1.10	0.77	46.17	23.56	2.59
1700	14.82	20.06	11.01	12.17	1.10	0.77	45.56	23.53	2.59
1750	14.74	20.00	10.69	12.02	1.10	0.78	49.30	23.45	2.45
1800	14.72	19.93	10.33	11.80	1.11	0.79	49.29	23.39	2.67
1850	14.68	19.87	10.11	11.88	1.10	0.79	45.35	23.68	2.58
1900	14.53	19.75	9.99	11.68	1.10	0.79	45.24	23.60	2.66
1950	14.42	19.75	9.93	11.87	1.10	0.80	44.13	23.69	2.75
2000	14.43	19.70	9.63	11.84	1.09	0.81	48.30	23.57	2.70
2050	14.27	19.68	9.66	12.01	1.09	0.81	47.29	23.50	2.68
2100	14.25	19.53	9.27	11.67	1.09	0.82	45.99	23.72	2.71
2150	14.11	19.53	9.14	11.87	1.09	0.83	46.22	23.64	2.72
2200	14.06	19.39	8.90	11.93	1.08	0.83	45.28	23.72	2.74
2250	13.99	19.37	8.73	11.65	1.07	0.83	43.20	23.71	2.79
2300	13.91	19.20	8.39	11.71	1.08	0.84	43.24	23.81	2.82
2350	13.86	19.26	8.28	12.06	1.08	0.84	44.15	23.87	2.68
2400	13.77	19.17	7.95	12.06	1.07	0.85	44.87	23.72	2.73
2500	13.67	19.08	7.64	12.38	1.06	0.87	42.99	23.75	2.89
2600	13.49	18.93	7.29	12.59	1.05	0.88	44.67	23.71	2.96
2700	13.38	18.82	6.79	12.96	1.02	0.89	43.30	23.71	2.99
2800	13.23	18.78	6.37	13.12	0.99	0.91	42.56	23.70	3.07
2900	13.10	18.55	5.93	13.27	0.97	0.92	43.58	23.53	3.09
3000	12.94	18.52	5.43	13.52	0.95	0.94	41.05	23.54	3.20

Typical Performance Data

Definitions:

Input Return Loss = -S11 (dB)

Gain(Power Gain) = S21 (dB)

Reverse Isolation = -S12 (dB)

Output Return Loss = -S22 (dB)

TEST CONDITIONS: Vd = 4.75V, Id = 135.23mA @ Temperature = +85degC

FREQ	Gain	Isolation	Input Return Loss	Output Return Loss	Stability		IP-3 Output	1dB Comp. Output	Noise Figure
					K	Measure			
(MHz)	(dB)	(dB)	(dB)	(dB)	K	Measure	(dBm)	(dBm)	(dB)
500	16.52	21.01	15.76	18.24	1.11	0.67	44.52	22.31	2.12
600	16.37	20.98	15.95	17.43	1.12	0.68	46.57	22.24	2.25
700	16.26	20.86	15.30	16.24	1.11	0.69	44.43	22.18	2.19
800	16.11	20.82	14.79	15.71	1.12	0.70	44.50	22.43	2.26
900	15.97	20.72	14.42	14.86	1.12	0.70	43.55	22.28	2.29
1000	15.86	20.65	13.78	14.08	1.11	0.71	43.95	22.59	2.39
1050	15.75	20.68	13.93	14.19	1.12	0.72	44.46	22.52	2.39
1100	15.68	20.53	13.52	13.86	1.11	0.71	43.39	22.68	2.32
1150	15.64	20.47	13.02	13.33	1.12	0.73	42.79	22.65	2.43
1200	15.51	20.43	13.00	13.29	1.11	0.73	44.45	22.53	2.43
1250	15.52	20.42	12.60	12.94	1.11	0.73	42.81	22.53	2.42
1300	15.40	20.37	12.64	12.98	1.11	0.74	42.87	22.55	2.47
1350	15.29	20.36	12.52	12.70	1.11	0.74	43.51	22.64	2.44
1400	15.24	20.22	12.08	12.67	1.11	0.74	43.02	22.76	2.46
1450	15.14	20.13	11.83	12.34	1.10	0.75	42.77	22.89	2.53
1500	15.07	20.15	11.73	12.50	1.11	0.76	42.04	22.88	2.54
1550	15.04	20.04	11.43	11.92	1.10	0.76	43.68	22.69	2.51
1600	14.93	19.99	11.23	12.04	1.11	0.77	43.52	23.00	2.57
1650	14.81	19.96	10.99	11.81	1.10	0.77	43.84	23.02	2.59
1700	14.72	19.98	11.10	12.14	1.10	0.77	44.15	22.98	2.45
1750	14.65	19.85	10.77	11.95	1.10	0.78	43.05	22.92	2.41
1800	14.62	19.77	10.42	11.68	1.11	0.78	43.54	22.85	2.64
1850	14.59	19.72	10.19	11.73	1.10	0.79	42.27	23.12	2.58
1900	14.45	19.60	10.07	11.44	1.10	0.79	41.89	23.04	2.55
1950	14.34	19.56	10.01	11.69	1.10	0.80	41.64	23.16	2.72
2000	14.34	19.53	9.70	11.74	1.09	0.81	44.11	23.04	2.66
2050	14.19	19.50	9.73	11.90	1.09	0.81	43.65	22.96	2.64
2100	14.15	19.41	9.33	11.55	1.09	0.81	43.16	23.17	2.67
2150	14.03	19.40	9.20	12.06	1.09	0.83	43.07	23.10	2.63
2200	13.98	19.24	8.97	12.00	1.08	0.83	42.65	23.17	2.70
2250	13.91	19.16	8.80	11.77	1.08	0.83	41.76	23.19	2.75
2300	13.83	19.06	8.46	12.24	1.08	0.84	41.20	23.26	2.72
2350	13.78	19.10	8.34	12.44	1.08	0.85	42.04	23.32	2.60
2400	13.69	19.02	8.01	12.25	1.07	0.85	43.58	23.17	2.69
2500	13.59	18.91	7.70	12.66	1.06	0.87	41.87	23.21	2.83
2600	13.42	18.76	7.33	12.89	1.04	0.87	42.40	23.18	2.88
2700	13.30	18.65	6.83	13.22	1.02	0.89	42.42	23.19	2.96
2800	13.16	18.59	6.41	13.46	0.99	0.91	41.44	23.15	3.05
2900	13.04	18.37	5.96	13.71	0.97	0.92	42.91	23.03	3.00
3000	12.88	18.33	5.45	14.15	0.95	0.94	42.30	23.00	3.12

Typical Performance Data

Definitions:

Input Return Loss = -S11 (dB)

Gain(Power Gain) = S21 (dB)

Reverse Isolation = -S12 (dB)

Output Return Loss = -S22 (dB)

TEST CONDITIONS: Vd = 5.25V, Id = 160.80mA @ Temperature = +85degC

FREQ	Gain	Isolation	Input Return Loss	Output Return Loss	Stability		IP-3 Output	1dB Comp. Output	Noise Figure
					K	Measure			
(MHz)	(dB)	(dB)	(dB)	(dB)	K	Measure	(dBm)	(dBm)	(dB)
500	16.68	21.19	15.53	17.98	1.11	0.67	44.47	23.24	2.23
600	16.53	21.12	15.70	17.53	1.12	0.68	44.49	23.18	2.37
700	16.42	21.06	15.11	16.51	1.11	0.69	43.66	23.12	2.30
800	16.27	20.99	14.59	15.71	1.12	0.70	45.41	23.39	2.37
900	16.12	20.94	14.21	15.11	1.12	0.71	44.31	23.20	2.39
1000	16.03	20.85	13.61	14.29	1.10	0.71	45.93	23.56	2.46
1050	15.91	20.86	13.75	14.06	1.12	0.72	46.44	23.49	2.52
1100	15.84	20.70	13.36	13.86	1.11	0.72	46.77	23.69	2.43
1150	15.81	20.66	12.86	13.34	1.12	0.73	47.35	23.66	2.55
1200	15.67	20.65	12.83	13.44	1.11	0.73	47.91	23.54	2.54
1250	15.67	20.62	12.45	13.31	1.11	0.74	47.47	23.53	2.53
1300	15.55	20.57	12.46	13.15	1.11	0.74	50.19	23.54	2.56
1350	15.45	20.55	12.34	12.91	1.11	0.74	46.62	23.66	2.55
1400	15.39	20.43	11.92	12.79	1.11	0.75	46.05	23.78	2.56
1450	15.30	20.36	11.69	12.51	1.11	0.75	45.82	23.93	2.65
1500	15.23	20.34	11.59	12.51	1.11	0.76	46.98	23.92	2.70
1550	15.19	20.24	11.29	12.24	1.10	0.76	45.50	23.72	2.66
1600	15.09	20.20	11.08	12.08	1.11	0.77	45.25	24.06	2.65
1650	14.96	20.15	10.86	11.99	1.10	0.77	44.25	24.06	2.66
1700	14.88	20.17	10.94	12.04	1.10	0.78	45.02	24.03	2.61
1750	14.80	20.10	10.63	12.01	1.10	0.78	46.06	23.96	2.53
1800	14.77	19.99	10.29	11.82	1.11	0.79	44.11	23.88	2.75
1850	14.75	19.94	10.05	11.59	1.10	0.79	44.84	24.19	2.67
1900	14.59	19.85	9.94	11.58	1.10	0.79	43.42	24.11	2.72
1950	14.48	19.83	9.88	11.78	1.10	0.80	44.16	24.19	2.77
2000	14.49	19.78	9.57	11.76	1.09	0.81	44.31	24.04	2.81
2050	14.33	19.76	9.61	12.00	1.08	0.81	44.04	23.97	2.77
2100	14.30	19.66	9.21	11.56	1.09	0.82	43.15	24.18	2.78
2150	14.16	19.61	9.09	11.81	1.09	0.83	43.40	24.12	2.81
2200	14.11	19.49	8.85	11.79	1.08	0.83	44.19	24.19	2.83
2250	14.05	19.46	8.69	11.84	1.07	0.83	42.34	24.21	2.85
2300	13.97	19.33	8.35	11.79	1.08	0.84	42.63	24.32	2.92
2350	13.92	19.34	8.25	11.98	1.08	0.85	42.89	24.36	2.75
2400	13.84	19.25	7.91	11.94	1.06	0.85	41.73	24.19	2.81
2500	13.72	19.19	7.61	12.51	1.06	0.87	41.49	24.22	2.96
2600	13.54	19.01	7.26	12.58	1.04	0.87	42.11	24.19	3.02
2700	13.42	18.93	6.77	12.67	1.02	0.89	41.54	24.19	3.10
2800	13.27	18.87	6.35	12.80	0.99	0.91	40.62	24.14	3.16
2900	13.15	18.67	5.91	13.25	0.97	0.92	40.61	23.98	3.18
3000	12.99	18.64	5.42	13.30	0.95	0.94	40.07	24.01	3.30

Typical Performance Curves

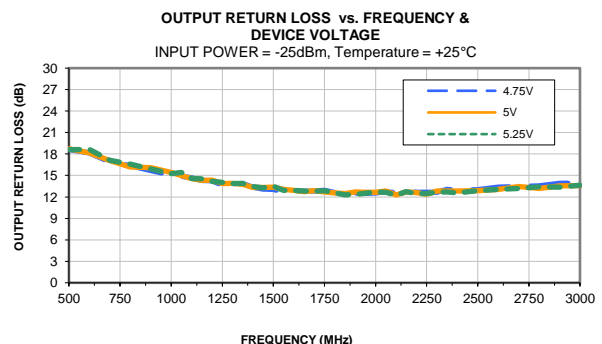
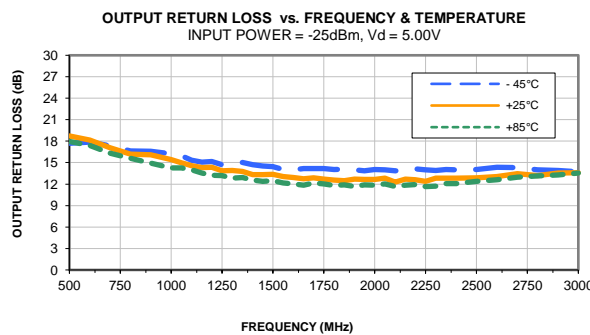
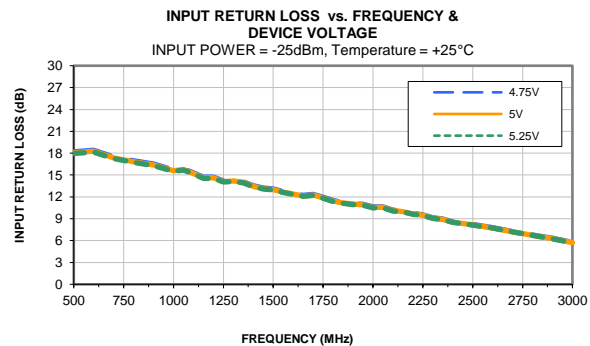
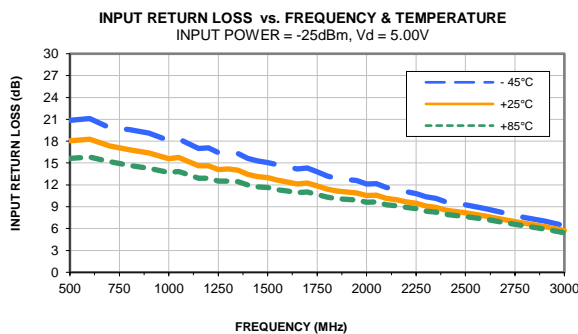
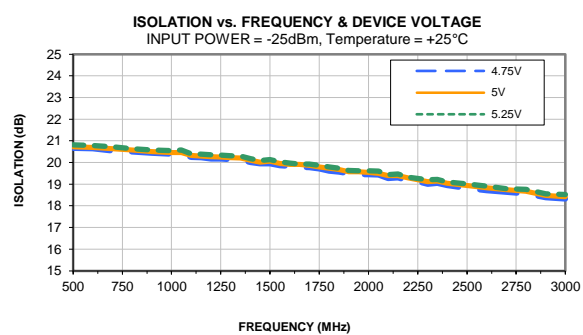
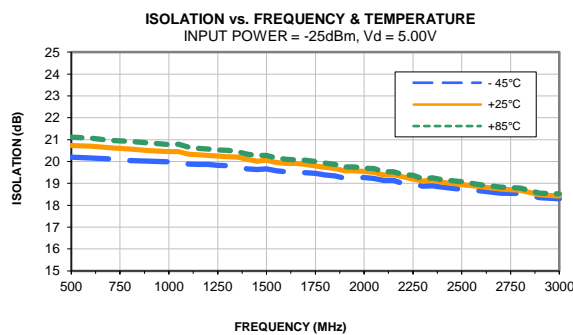
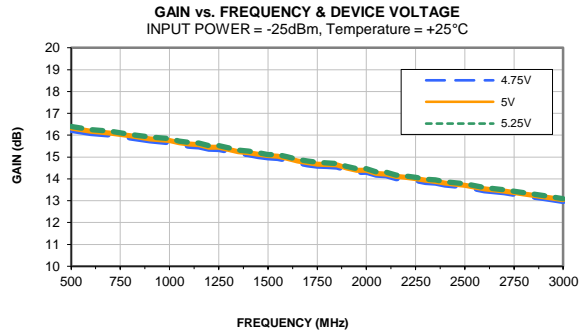
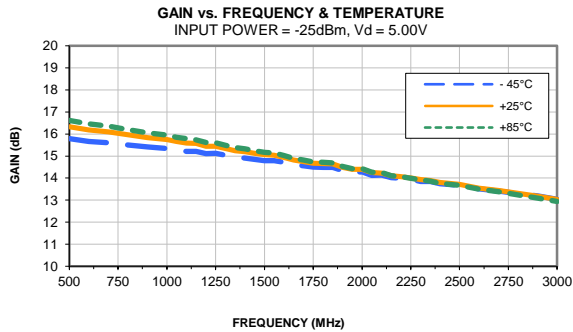

Typical Performance Curves

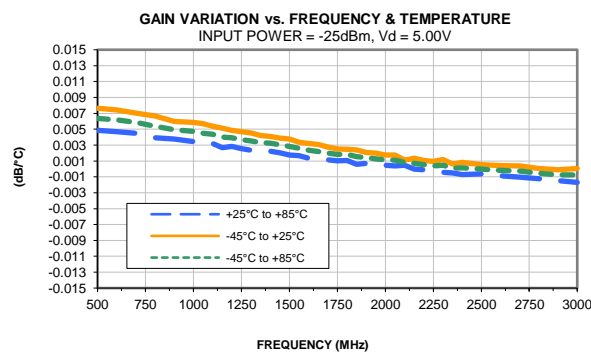
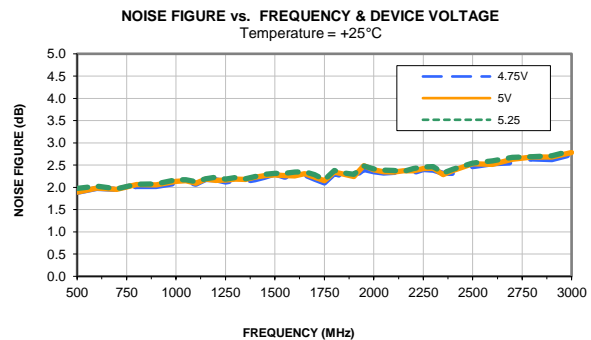
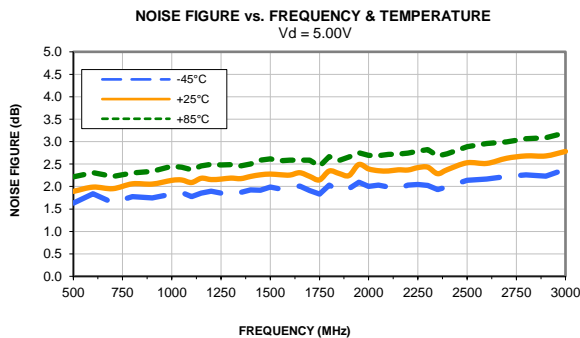
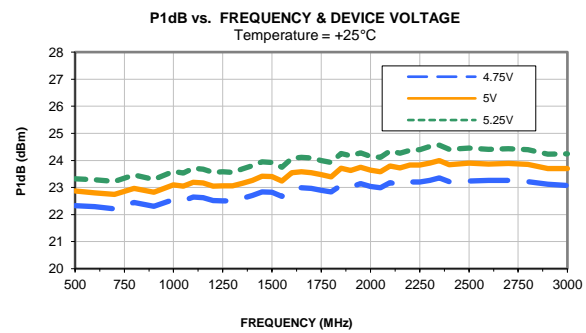
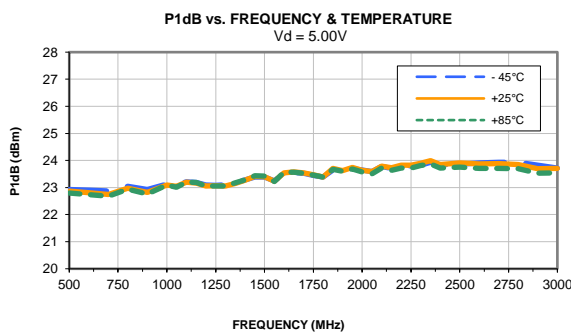
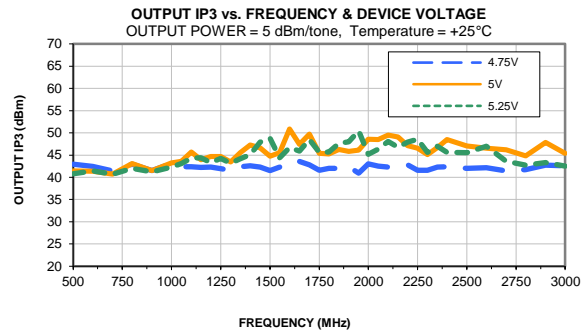
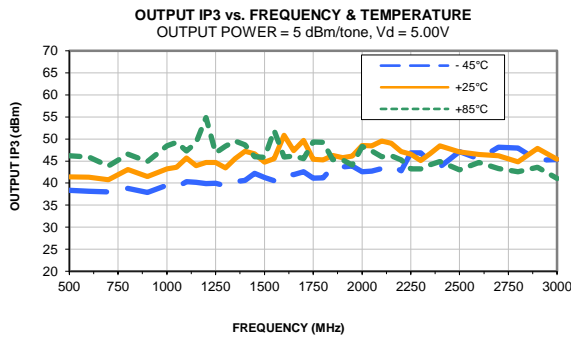

Outline Dimensions

LZ1671

PCB Land Pattern

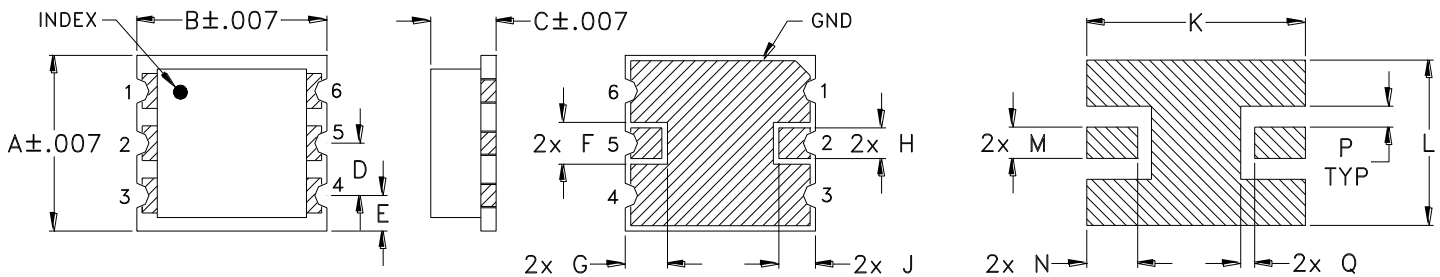

Suggested Layout
Pattern to be within $\nabla .002$

CASE #	A	B	C	D	E	F	G	H	J	K	L	M
LZ1671	.252 (6.40)	.274 (6.96)	.094 (2.40)	.075 (1.91)	.051 (1.30)	.060 (1.53)	.061 (1.55)	.044 (1.12)	.053 (1.35)	.290 (7.37)	.237 (6.02)	.045 (1.14)

CASE #	N	P	Q	R	WT. GRAM
LZ1671	.060 (1.52)	.030 (.76)	.020 (.51)	-	0.20

Dimensions are in inches (mm). Tolerances: 3 Pl. $\pm .003$ unless otherwise specified

Notes:

1. Case material: Ceramic.
2. Base material: 20 mil thk laminate.
3. Termination finish: 3-5 μ inch (0.075-0.125 microns) gold plating over 120-240 μ inch (3-6 microns) low stress electroless nickel.



INTERNET <http://www.minicircuits.com>

P.O. Box 350166, Brooklyn, New York 11235-0003 (718) 934-4500 Fax (718) 332-4661

Distribution Centers NORTH AMERICA 800-654-7949 • 417-335-5935 • Fax 417-335-5945 • EUROPE 44-1252-832600 • Fax 44-1252-837010

Mini-Circuits ISO 9001 & ISO 14001 Certified

Tape & Reel Packaging TR-F78

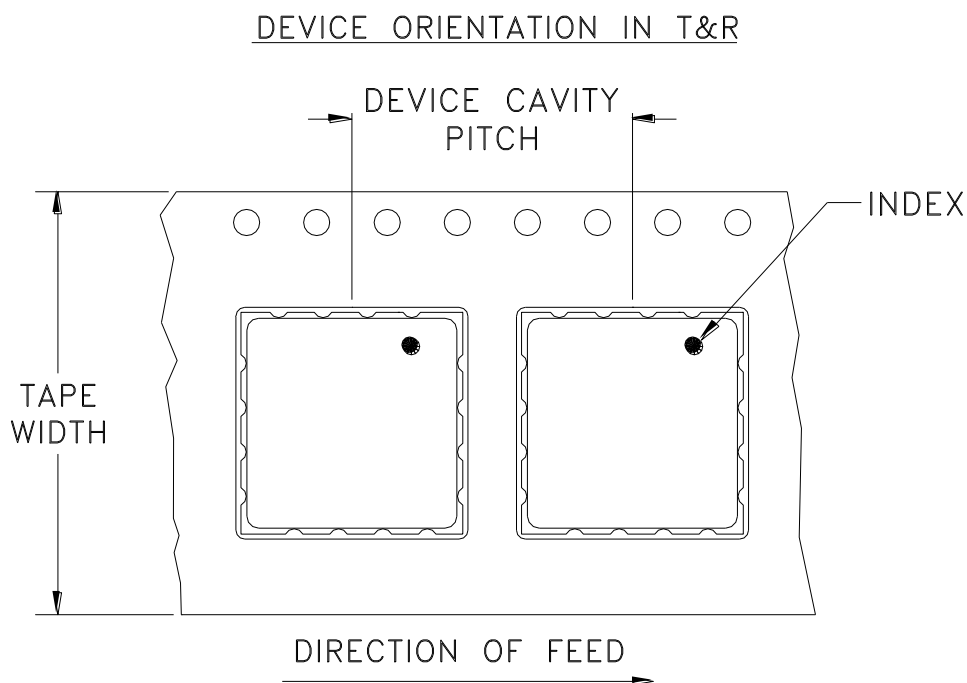

Tape Width, mm	Device Cavity Pitch, mm	Reel Size, inches	Devices per Reel see note
16	12	7	10
			20
			50
			100
		13	200
			500, 1000

Note: Please consult individual model data sheet to determine device per reel availability.

Mini-Circuits carrier tape materials provide protection from ESD (Electro-Static Discharge) during handling and transportation. Tapes are static dissipative and comply with industry standards EIA-481/EIA-541.

Go to: www.minicircuits.com/pages/pdfs/tape.pdf



INTERNET <http://www.minicircuits.com>

P.O. Box 350166, Brooklyn, New York 11235-0003 (718) 934-4500 Fax (718) 332-4661

Distribution Centers NORTH AMERICA 800-654-7949 • 417-335-5935 • Fax 417-335-5945 • EUROPE 44-1252-832600 • Fax 44-1252-837010

Mini-Circuits ISO 9001 & ISO 14001 Certified

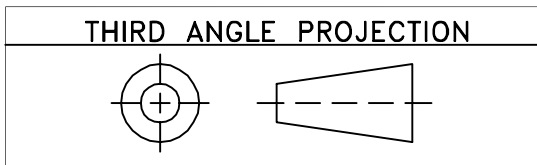

REVISIONS					
REV OR	ECN No.	DESCRIPTION	DATE	DR	AUTH
	M133067	NEW RELEASE	10/31/11	IL	DJ

SUGGESTED MOUNTING CONFIGURATION FOR LZ1671 CASE STYLE, "06AM03" PIN CODE

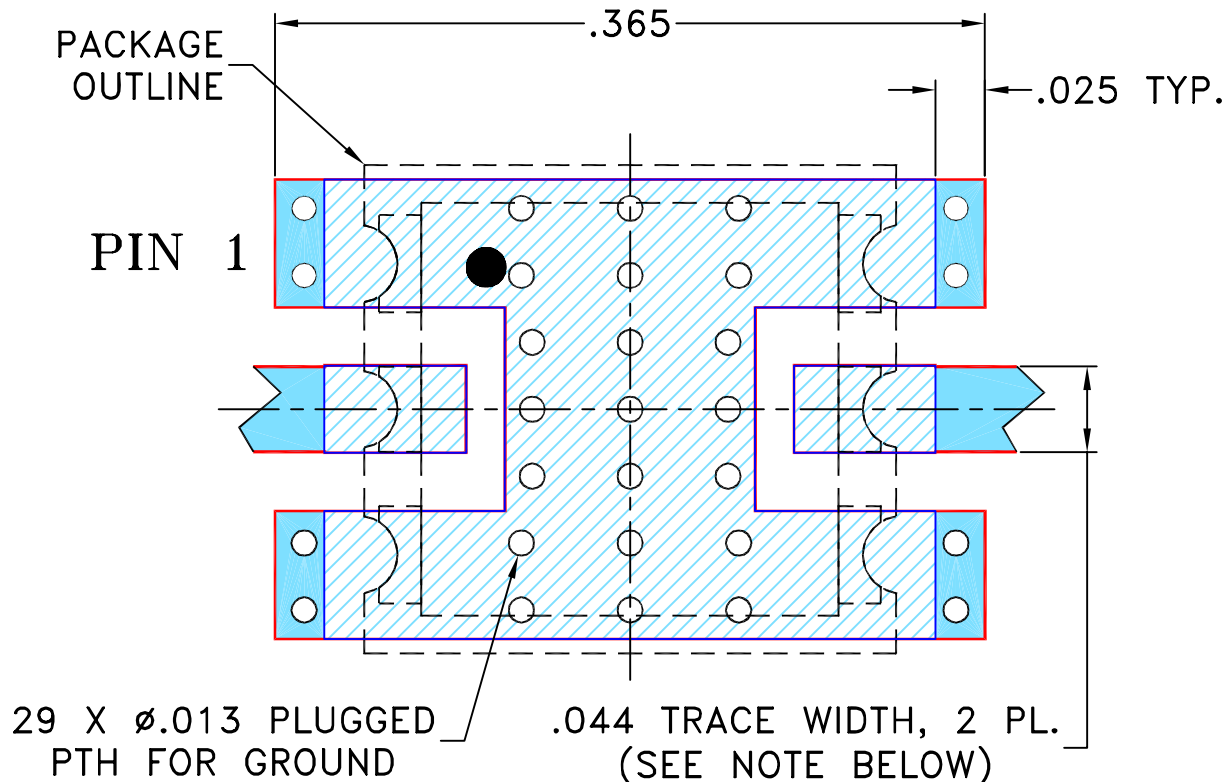

NOTES:

- TRACE WIDTH IS SHOWN FOR ROGERS R04350B WITH DIELECTRIC THICKNESS .020" ± .0015"; COPPER: 1/2 OZ. EACH SIDE. FOR OTHER MATERIALS TRACE WIDTH MAY NEED TO BE MODIFIED.
- BOTTOM SIDE OF THE PCB IS CONTINUOUS GROUND PLANE.



DENOTES PCB COPPER LAYOUT WITH SMOBC (SOLDER MASK OVER BARE COPPER)



DENOTES COPPER LAND PATTERN FREE OF SOLDER MASK

UNLESS OTHERWISE SPECIFIED	INITIALS	DATE
DIMENSIONS ARE IN INCHES TOLERANCES ON: 2 PL DECIMALS ± 3 PL DECIMALS ± .005 ANGLES ± FRACTIONS ±	DRAWN	IL 08/04/11
	CHECKED	AV 10/31/11
	APPROVED	DJ 10/31/11



Mini-Circuits®

13 Neptune Avenue
Brooklyn NY 11235

PL, 06AM03, LZ1671, TB-641+

Mini-Circuits®
 THIS DOCUMENT AND ITS CONTENTS ARE THE PROPERTY OF MINI-CIRCUITS. EXCEPT FOR USE EXPRESSLY GRANTED, IN WRITING, TO ITS VENDORS, VENDEE AND THE UNITED STATES GOVERNMENT, MINI-CIRCUITS RESERVES ALL PROPRIETARY DESIGN, USE, MANUFACTURING AND REPRODUCTION RIGHTS THERETO. THESE CONTENTS SHALL NOT BE USED, DUPLICATED OR DISCLOSED TO ANY OUTSIDE PARTY, IN WHOLE OR IN PART, WITHOUT WRITTEN PERMISSION OF MINI-CIRCUITS.

ASHEETA1.DWG REV:A DATE:01/12/95

SIZE	CODE IDENT	DRAWING NO:	REV:
A	15542	98-PL-350	OR
FILE:	98PL350	SCALE: 10:1	SHEET: 1 OF 1

Evaluation Board and Circuit

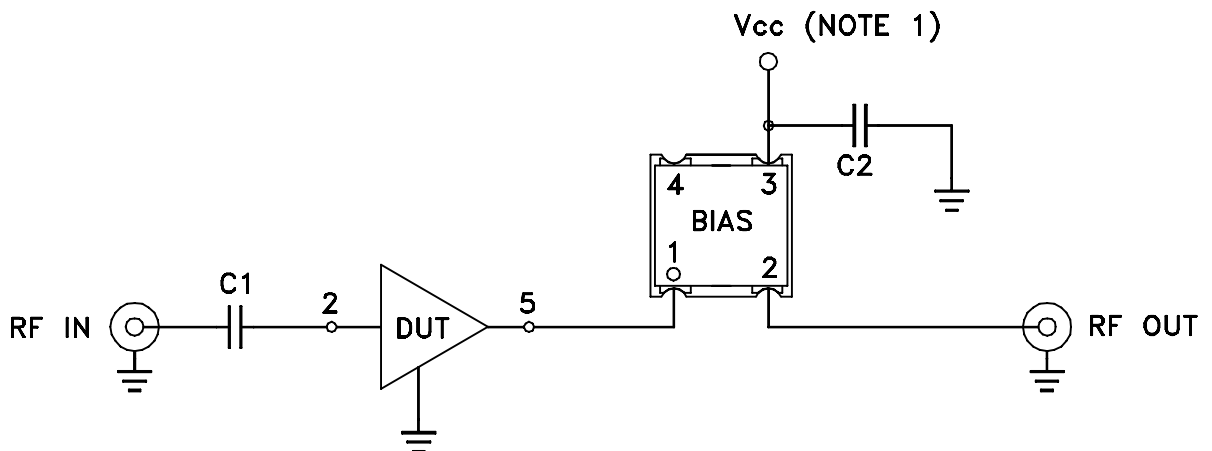
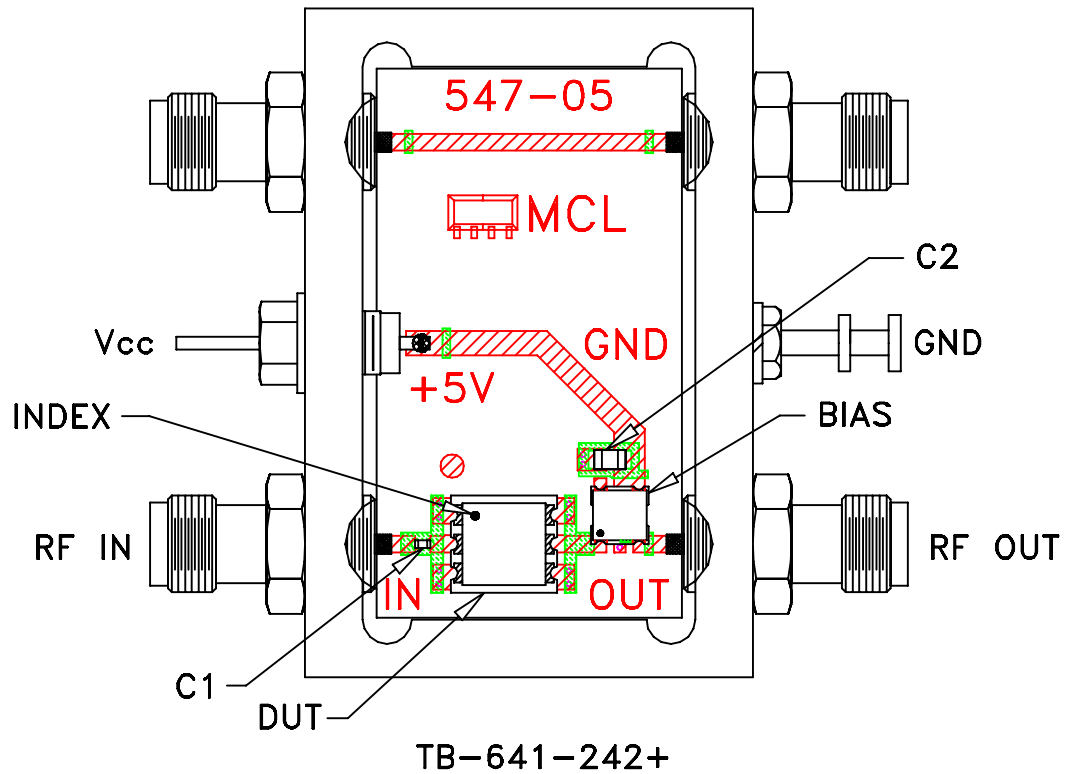

COMPONENT	DESCRIPTION
DUT	HXG-242+
C1	0.001 μ F
C2	0.01 μ F
BIAS TEE	Mini-Circuits TCBT-14+

Schematic Diagram

NOTES:

1. Vcc voltage: +5V.
2. SMA Female connectors.
3. PCB material: Rogers R04350 or equivalent, dielectric constant=3.5, dielectric thickness=.020 inch.

 Mini-Circuits®



All Mini-Circuits products are manufactured under exacting quality assurance and control standards, and are capable of meeting published specifications after being subjected to any or all of the following physical and environmental test.

Specification	Test/Inspection Condition	Reference/Spec
Operating Temperature	-40° to 85°C	Individual Model Data Sheet
Storage Temperature	-65° to 150° C Ambient Environment	Individual Model Data Sheet
HTOL	1000 hours at 85°C	MIL-STD-883, Method 1005, Condition B
Temperature Cycling	-65° to 150°C, 500 cycles	JESD22-A104, condition C
Autoclave	121°C, 100% RH, 15 PSIG, 96 hours	JESD22-A102, Condition C
High Temp Storage	150°C 168 hours	JESD22-A103, condition B
Solderability, SMT Method	Steam Aging: 8 hours. Solder Reflow for SnAgCu: 245°C+5°C, SnPb: 225°C+5°C	JESD22-B102, Method 2
Marking Resistance to Solvents	Solution A, B, C. Continue with reflow at Tmax: 260°C	JESD22-B017D