



Product Description

The SGA6289Z is a high performance SiGe HBT MMIC Amplifier. A Darlington configuration featuring one-micron emitters provides high F_T and excellent thermal performance. The heterojunction increases breakdown voltage and minimizes leakage current between junctions. Cancellation of emitter junction non-linearities results in higher suppression of intermodulation products. Only two DC-blocking capacitors, a bias resistor, and an optional RF choke are required for operation.

Features

- Broadband Operation: DC to 4500 MHz
- Cascadable 50Ω
- Operates from Single Supply
- Low Thermal Resistance Package

Applications

- PA Driver Amplifier
- Cellular, PCS, GSM, UMTS
- IF Amplifier
- Wireless Data, Satellite

Optimum Technology Matching® Applied

- GaAs HBT
- GaAs MESFET
- InGaP HBT
- SiGe BiCMOS
- Si BiCMOS
- SiGe HBT
- GaAs pHEMT
- Si CMOS
- Si BJT
- GaN HEMT
- InP HBT
- RF MEMS
- LDMOS

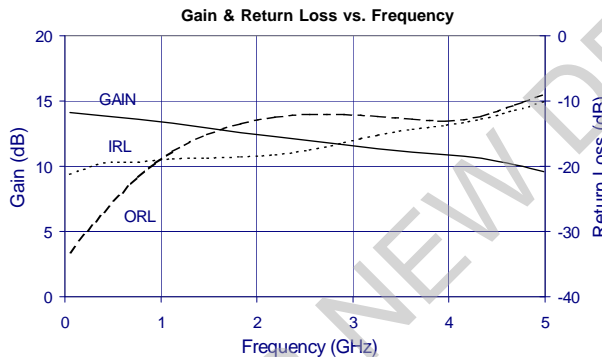

Parameter	Specification			Unit	Condition
	Min.	Typ.	Max.		
Small Signal Gain	12.3	13.9	15.1	dB	850 MHz
		12.6		dB	1950 MHz
		12.2		dB	2400 MHz
Output Power at 1dB Compression		18.1		dBm	850 MHz
		17.8		dBm	1950 MHz
Output Third Intercept Point		34.4		dBm	850 MHz
		32.0		dBm	1950 MHz
Bandwidth Determined by Return Loss		4500		MHz	>10 dB
Input Return Loss		18.5		dB	1950 MHz
Output Return Loss		13.1		dB	1950 MHz
Noise Figure		4.0		dB	1950 MHz
Device Operating Voltage	3.6	4.0	4.4	V	
Device Operating Current	67	75	83	mA	
Thermal Resistance (Junction - Lead)		97		°C/W	

Test Conditions: $V_S=8V$, $I_D=75\text{ mA Typ.}$, OIP_3 Tone Spacing = 1 MHz, P_{OUT} per tone = 0 dBm, $R_{BIAS}=51\Omega$, $T_L=25^\circ\text{C}$, $Z_S=Z_L=50\Omega$

Absolute Maximum Ratings

Parameter	Rating	Unit
Max Device Current (I_D)	150	mA
Max Device Voltage (V_D)	6	V
Max RF Input Power	+18	dBm
Max Junction Temp (T_J)	+150	°C
Operating Temp Range (T_L)	-40 to +85	°C
Max Storage Temp	+150	°C
Moisture Sensitivity Level	MSL 2	



Caution! ESD sensitive device.

Exceeding any one or a combination of the Absolute Maximum Rating conditions may cause permanent damage to the device. Extended application of Absolute Maximum Rating conditions to the device may reduce device reliability. Specified typical performance or functional operation of the device under Absolute Maximum Rating conditions is not implied.

RoHS status based on EU Directive 2002/95/EC (at time of this document revision).

The information in this publication is believed to be accurate and reliable. However, no responsibility is assumed by RF Micro Devices, Inc. ("RFMD") for its use, nor for any infringement of patents, or other rights of third parties, resulting from its use. No license is granted by implication or otherwise under any patent or patent rights of RFMD. RFMD reserves the right to change component circuitry, recommended application circuitry and specifications at any time without prior notice.

Operation of this device beyond any one of these limits may cause permanent damage. For reliable continuous operation, the device voltage and current must not exceed the maximum operating values specified in the table on page one.

Bias Conditions should also satisfy the following expression:

$$I_D V_D < (T_J - T_L) / R_{TH, j-l}$$

Typical Performance at Key Operating Frequencies

Parameter	Unit	100 MHz	500 MHz	850 MHz	1950 MHz	2400 MHz	3500 MHz
Small Signal Gain	dB	13.5	14.0	13.9	12.6	12.2	10.6
Output Third Order Intercept Point	dBm	36.0	35.0	34.4	32.0	31.2	28.2
Output Power at 1dB Compression	dBm	18.7	18.6	18.1	17.8	17.1	15.6
Input Return Loss	dB	20.8	19.5	19.3	18.5	17.9	14.7
Output Return Loss	dB	32.8	25.6	20.6	13.1	12.2	12.6
Reverse Isolation	dB	17.4	18.6	18.9	19.2	19.1	18.1
Noise Figure	dB	3.9	3.8	3.7	4.0	4.6	5.1

Test Conditions: $V_S = 8V$, $I_D = 75\text{ mA Typ.}$, OIP_3 Tone Spacing = 1MHz, P_{OUT} per tone = 0dBm, $R_{BIAS} = 51\Omega$, $T_L = 25^\circ\text{C}$, $Z_S = Z_L = 50\Omega$

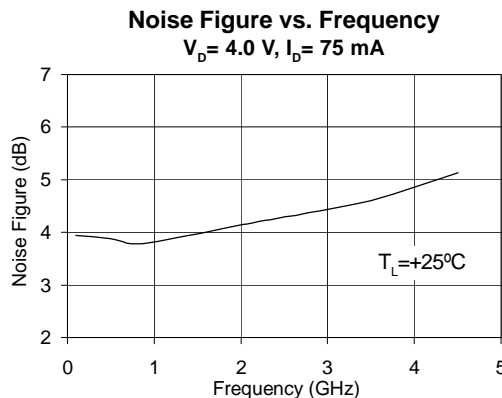
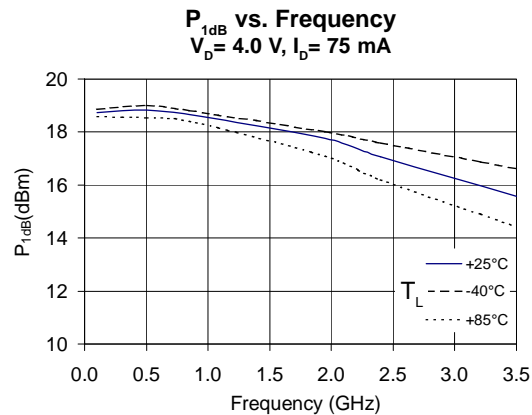
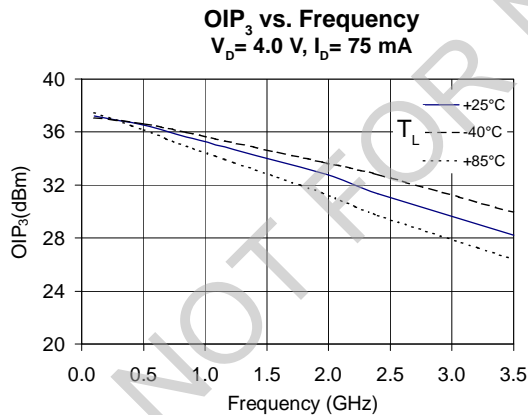

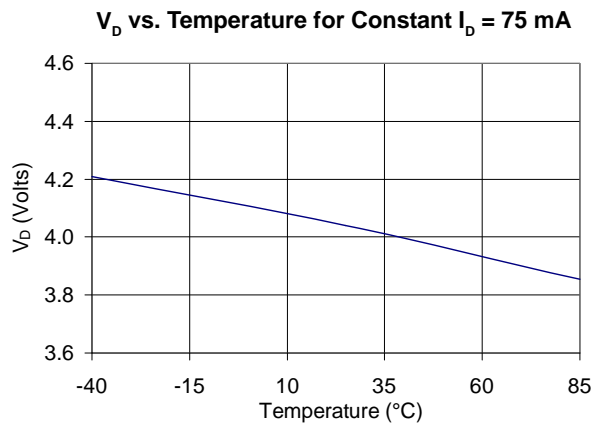
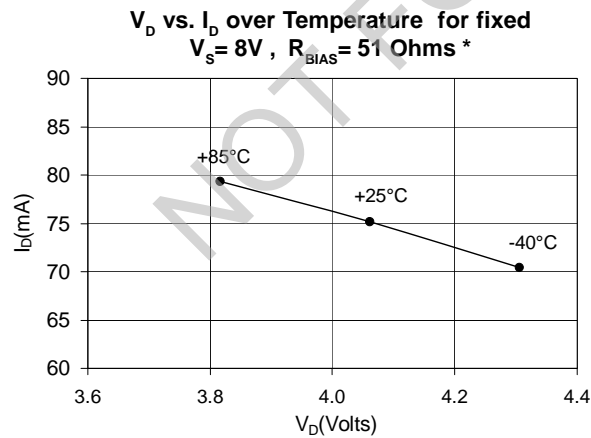
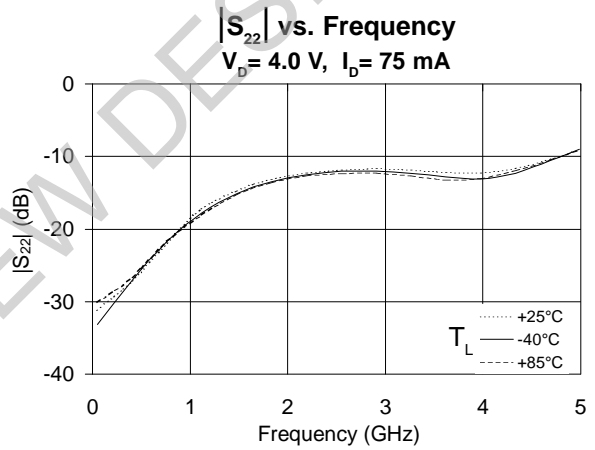
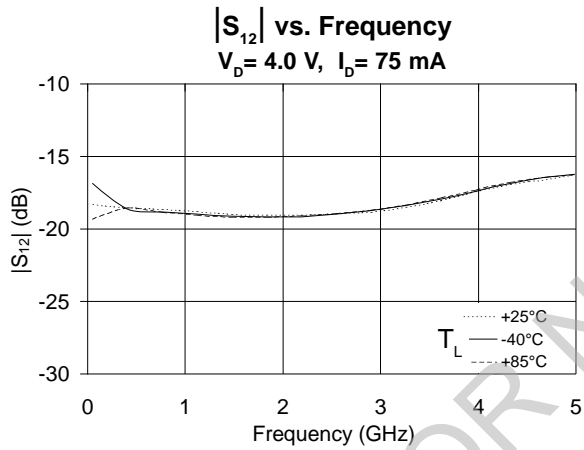
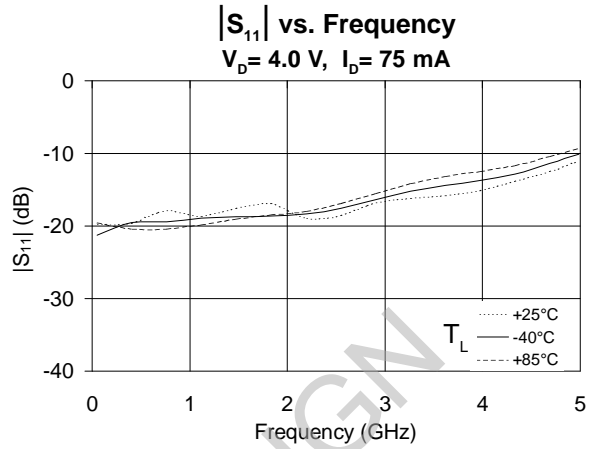
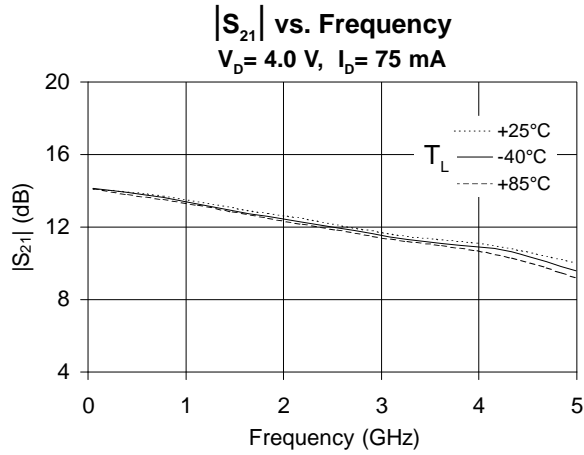

* Note: In the applications circuit on page 4, R_{BIAS} compensates for voltage and current variation over temperature.

Pin	Function	Description
1	RF IN	RF input pin. This pin requires the use of an external DC-blocking capacitor chosen for the frequency of operation.
2, 4	GND	Connection to ground. For optimum RF performance use via holes as close to ground leads as possible to reduce lead inductance.
3	RF OUT/BIAS	RF output and bias pin. DC voltage is present on this pin, therefore a DC-blocking capacitor is necessary for proper operation.

Suggested Pad Layout

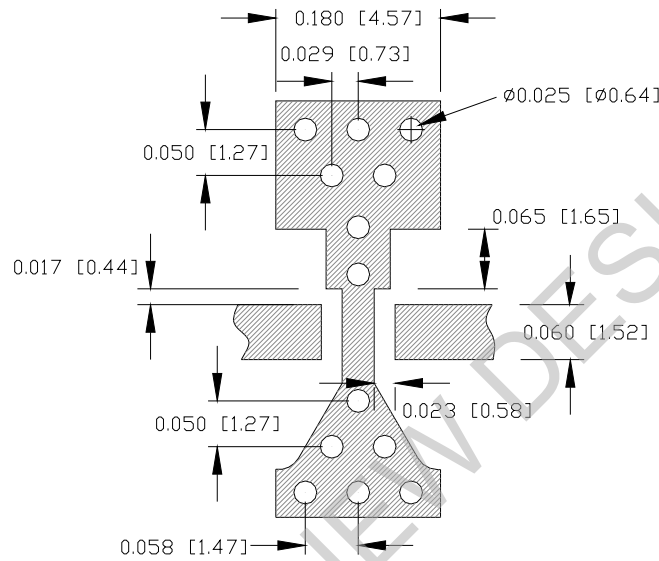

Package Drawing

Dimensions in inches (millimeters)

Refer to drawing posted at www.rfmd.com for tolerances.

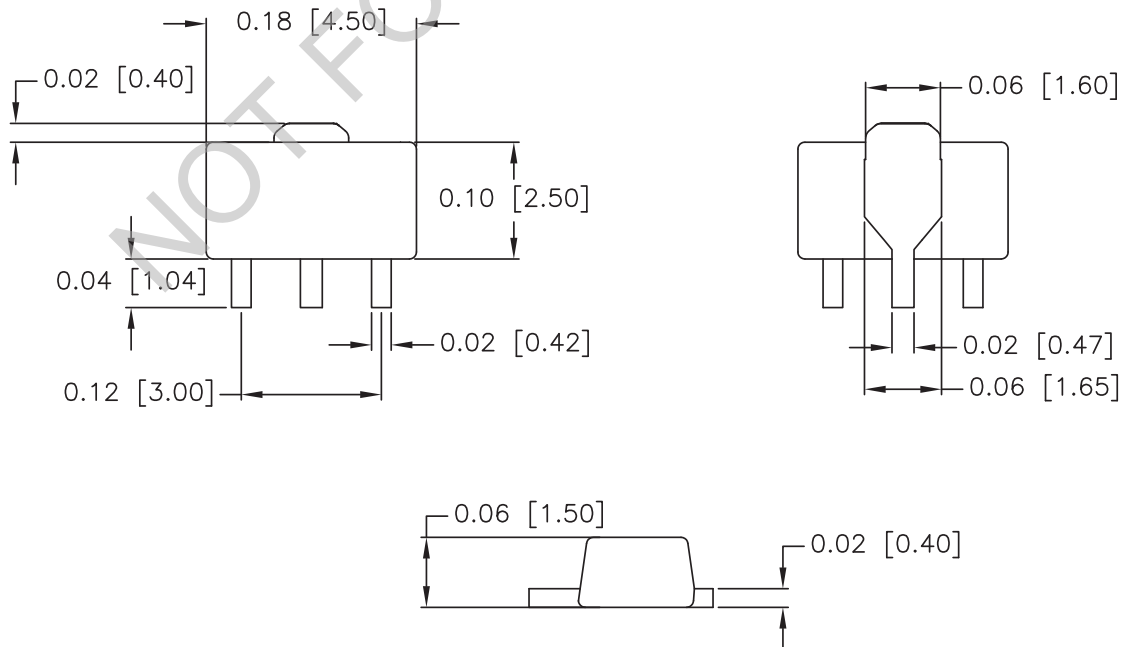

Application Schematic

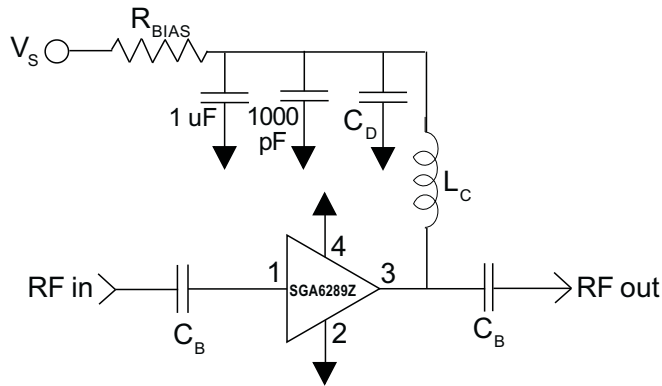

Reference Designator	Frequency (Mhz)				
	500	850	1950	2400	3500
C _B	220 pF	100 pF	68 pF	56 pF	39 pF
C _D	100 pF	68 pF	22 pF	22 pF	15 pF
L _C	68 nH	33 nH	22 nH	18 nH	15 nH

Recommended Bias Resistor Values for I _D =75mA					
$R_{BIAS} = (V_S - V_D) / I_D$					
Supply Voltage(V _S)	6 V	8 V	10 V	12 V	
R _{BIAS}	27 Ω	51 Ω	82 Ω	110 Ω	

Note: R_{BIAS} provides DC bias stability over temperature.

Evaluation Board Layout

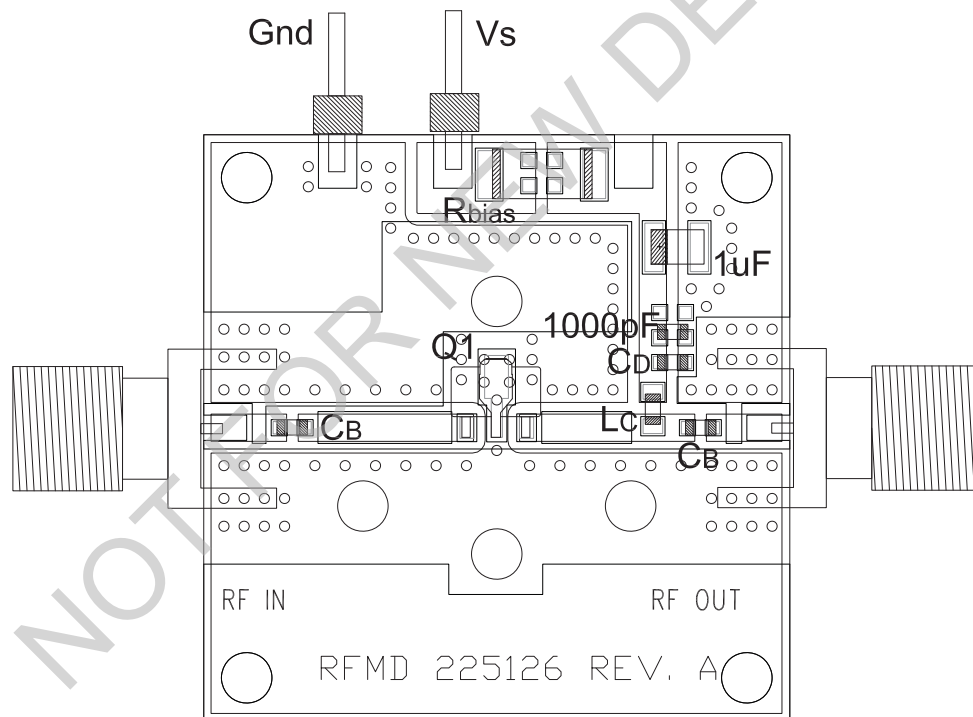

Mounting Instructions:

1. Solder the copper pad on the backside of the device package to the ground plane.
2. Use a large ground pad area with many plated through-holes as shown.
3. We recommend 1 or 2 ounce copper. Measurements for this data sheet were made on a 31mil thick FR-4 board with 1 ounce copper on both sides.

Part Identification

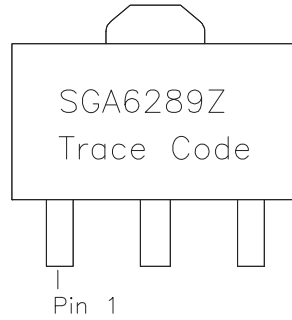

Ordering Information

Ordering Code	Description
SGA6289Z	13" Reel with 3000 pieces
SGA6289ZSQ	Sample bag with 25 pieces
SGA6289ZSR	7" Reel with 100 pieces
SGA6289ZPCK1	850MHz, 8V Operation PCBA with 5-piece sample bag

NOT FOR NEW DESIGN

Mouser Electronics

Authorized Distributor

Click to View Pricing, Inventory, Delivery & Lifecycle Information:

[Qorvo:](#)

[SGA6289Z](#)