

V.H.F. POWER TRANSISTORS

N-P-N silicon planar epitaxial transistors intended for use in class-A, B or C operated mobile transmitters with a nominal supply voltage of 13,5 V. The transistors are resistance stabilized and guaranteed to withstand severe load mismatch conditions with a supply over-voltage to 16,5 V. The BFQ43 and BFQ43S are especially suited as driver transistors for the BLW31 in a two-stage wideband or semi-wideband v.h.f. amplifier delivering 28 W output power.

The BFQ43 and BFQ43S have a TO-39 metal envelope with the emitter connected to the case which enables excellent heatsinking and emitter grounding.

QUICK REFERENCE DATA

R.F. performance up to $T_h = 25^\circ\text{C}$

mode of operation	V_{CE} V	f MHz	P_L W	G_p dB	η %	\bar{Z}_i Ω	\bar{Y}_L mS
c.w. class-B	13,5	175	4	> 12	> 55	$3,2 + j0,03$	$53 - j29$
c.w. class-B	12,5	175	4	typ. 12	typ. 60	—	—

MECHANICAL DATA

Dimensions in mm

Fig.1 TO-39/3; emitter connected to case.

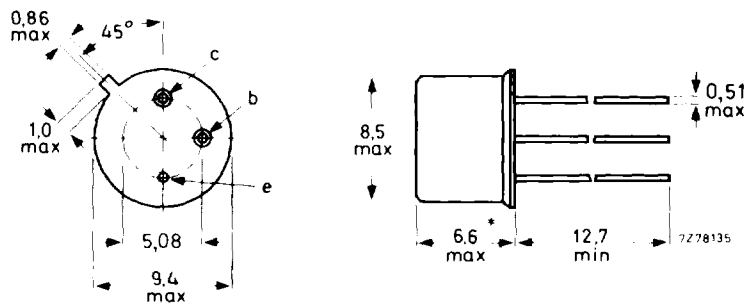

Maximum lead diameter is guaranteed only for 12,7 mm.

* Max. 4,9 for BFQ43S.

PRODUCT SAFETY This device incorporates beryllium oxide, the dust of which is toxic. The device is entirely safe provided that the BeO disc is not damaged.

RATINGS

Limiting values in accordance with the Absolute Maximum System (IEC 134)

Collector-emitter voltage ($V_{BE} = 0$)
peak value

V_{CESM} max. 36 V

Collector-emitter voltage (open base)

V_{CEO} max. 18 V

Emitter-base voltage (open collector)

V_{EBO} max. 4 V

Collector current (average)

$I_{C(AV)}$ max. 1,25 A

Collector current (peak value); $f > 1$ MHz

I_{CM} max. 3,75 A

Total power dissipation up to $T_{mb} = 25$ °C

P_{tot} max. 12 W

Storage temperature

T_{stg} -65 to + 175 °C

Operating junction temperature

T_j max. 200 °C

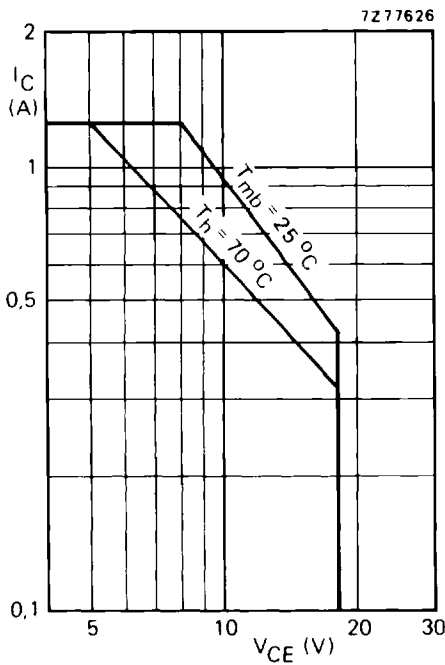
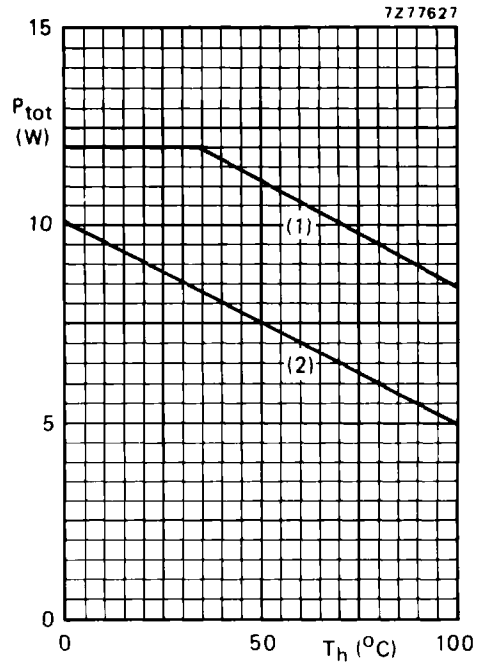

Fig. 2 D.C. SOAR.



- (1) Short-time r.f. operation during mismatch; $f \geq 1$ MHz.
- (2) Continuous d.c. and r.f. operation; derate by 0,05 W/K.

Fig. 3 Total power dissipation; $V_{CE} \leq 16,5$ V.

THERMAL RESISTANCE (dissipation = 4 W; $T_{mb} = 82$ °C, i.e. $T_h = 70$ °C)

From junction to mounting base

$R_{th\ j-mb}$ = 18 K/W

From mounting base to heatsink

$R_{th\ mb-h}$ = 3 K/W

CHARACTERISTICS

 $T_j = 25\text{ }^\circ\text{C}$

Collector-emitter breakdown voltage

 $V_{BE} = 0; I_C = 5\text{ mA}$ $V_{(BR)CES} > 36\text{ V}$

Collector-emitter breakdown voltage

open base; $I_C = 50\text{ mA}$ $V_{(BR)CEO} > 18\text{ V}$

Emitter-base breakdown voltage

open collector; $I_E = 2\text{ mA}$ $V_{(BR)EBO} > 4\text{ V}$

Collector cut-off current

 $V_{BE} = 0; V_{CE} = 18\text{ V}$ $I_{CES} < 2\text{ mA}$ Second breakdown energy; $L = 25\text{ mH}; f = 50\text{ Hz}$

open base

 $ESBO > 0,5\text{ mJ}$ $R_{BE} = 10\text{ }\Omega$ $ESBR > 0,5\text{ mJ}$

D.C. current gain *

 $I_C = 0,5\text{ A}; V_{CE} = 5\text{ V}$ h_{FE} typ. 40
10 to 80

Collector-emitter saturation voltage *

 $I_C = 1,5\text{ A}; I_B = 0,3\text{ A}$ V_{CEsat} typ. 0,9 VTransition frequency at $f = 100\text{ MHz}$ * $-I_E = 0,5\text{ A}; V_{CB} = 13,5\text{ V}$ f_T typ. 750 MHz $-I_E = 1,5\text{ A}; V_{CB} = 13,5\text{ V}$ f_T typ. 625 MHzCollector capacitance at $f = 1\text{ MHz}$ $I_E = I_e = 0; V_{CB} = 13,5\text{ V}$ C_C typ. 15 pFFeedback capacitance at $f = 1\text{ MHz}$ $I_C = 20\text{ mA}; V_{CE} = 13,5\text{ V}$ C_{re} typ. 7,3 pF* Measured under pulse conditions: $t_p \leq 200\text{ }\mu\text{s}; \delta \leq 0,02$.

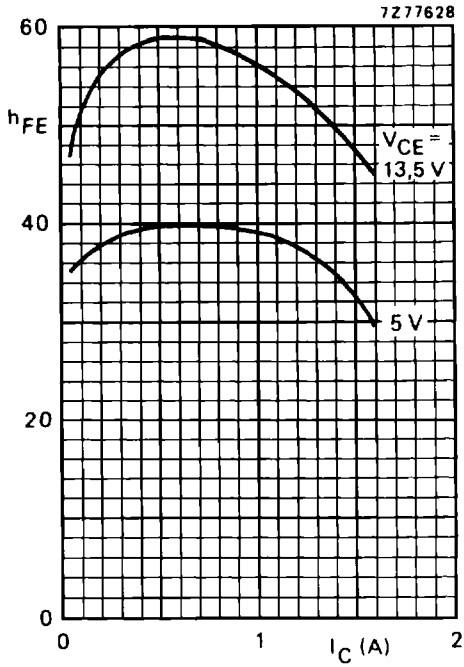

Fig. 4 Typical values; $T_j = 25\text{ }^\circ\text{C}$.

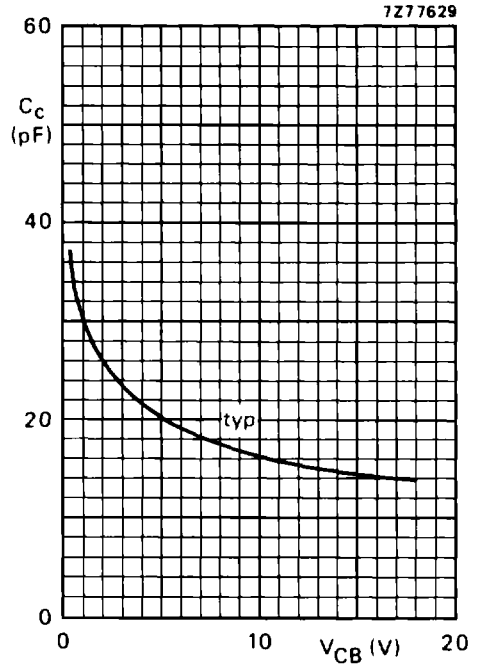

Fig. 5 $I_E = I_e = 0$; $f = 1\text{ MHz}$; $T_j = 25\text{ }^\circ\text{C}$.

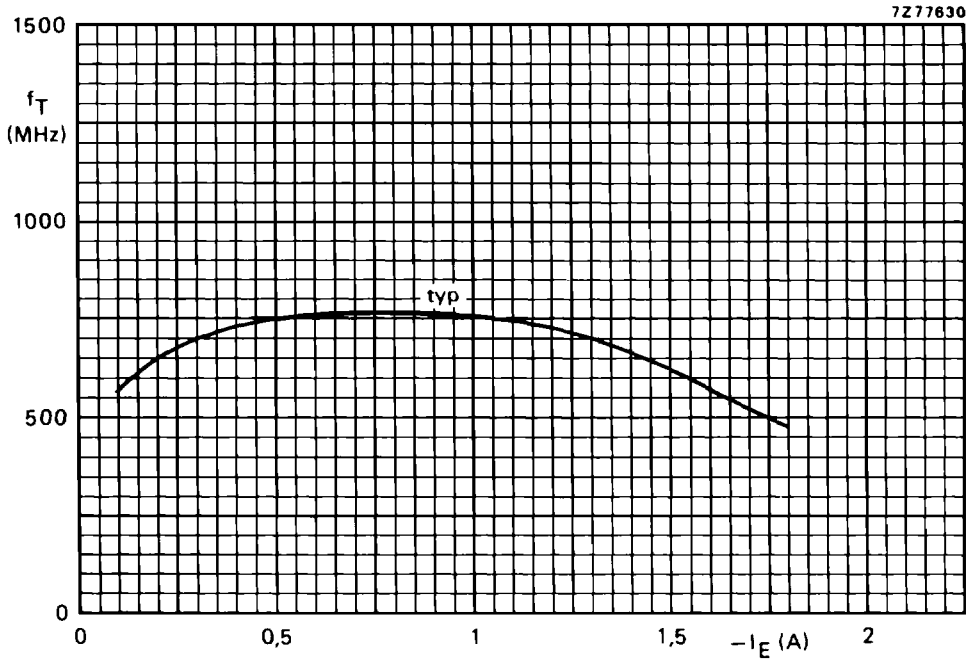

Fig. 6 $V_{CB} = 13.5\text{ V}$; $f = 100\text{ MHz}$; $T_j = 25\text{ }^\circ\text{C}$.

APPLICATION INFORMATION

R.F. performance in c.w. operation (unneutralized common-emitter class-B circuit)

 $T_h = 25\text{ }^\circ\text{C}$

f (MHz)	V_{CE} (V)	P_L (W)	P_S (W)	G_p (dB)	I_C (A)	η (%)	\bar{z}_i (Ω)	\bar{Y}_L (mS)
175	13,5	4	< 0,25	> 12	< 0,54	> 55	3,2 + j0,03	53 - j29
175	12,5	4	-	typ. 12	-	typ. 60	-	-

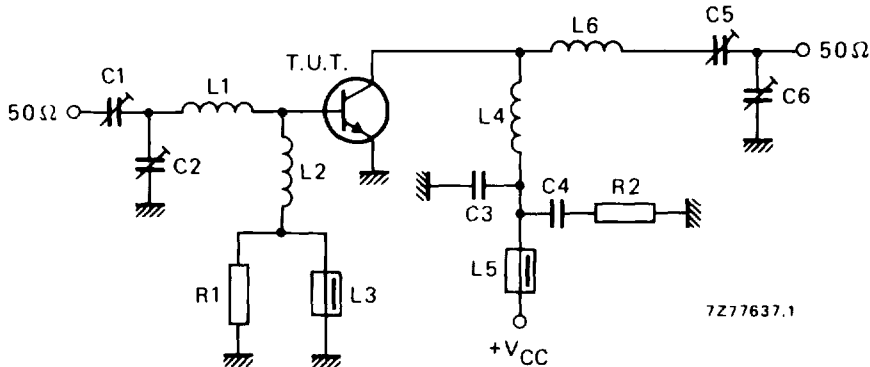

Fig. 7 Test circuit; c.w. class-B.

List of components:

C1 = C5 = 2,5 to 20 pF film dielectric trimmer (cat. no. 2222 809 07004)

C2 = C6 = 4 to 40 pF film dielectric trimmer (cat. no. 2222 809 07008)

C3 = 100 pF ceramic capacitor

C4 = 100 nF polyester capacitor

L1 = 2 turns Cu wire (1,0 mm); int. dia. 4,0 mm; length 3 mm; leads 2 x 5 mm

L2 = 7 turns enamelled Cu wire (0,5 mm); int. dia. 3,0 mm; length 4 mm; leads 2 x 5 mm

L3 = L5 = Ferroxcube wide-band h.f. choke, grade 3B (cat. no. 4312 020 36640)

L4 = 4 turns enamelled Cu wire (1,0 mm); int. dia. 5,5 mm; length 5 mm; leads 2 x 5 mm

L6 = 5 turns enamelled Cu wire (1,0 mm); int. dia. 5,5 mm; length 7,5 mm; leads 2 x 5 mm

R1 = R2 = 10 Ω carbon resistor

Component layout and printed-circuit board for 175 MHz test circuit are shown in Fig. 8.

APPLICATION INFORMATION (continued)

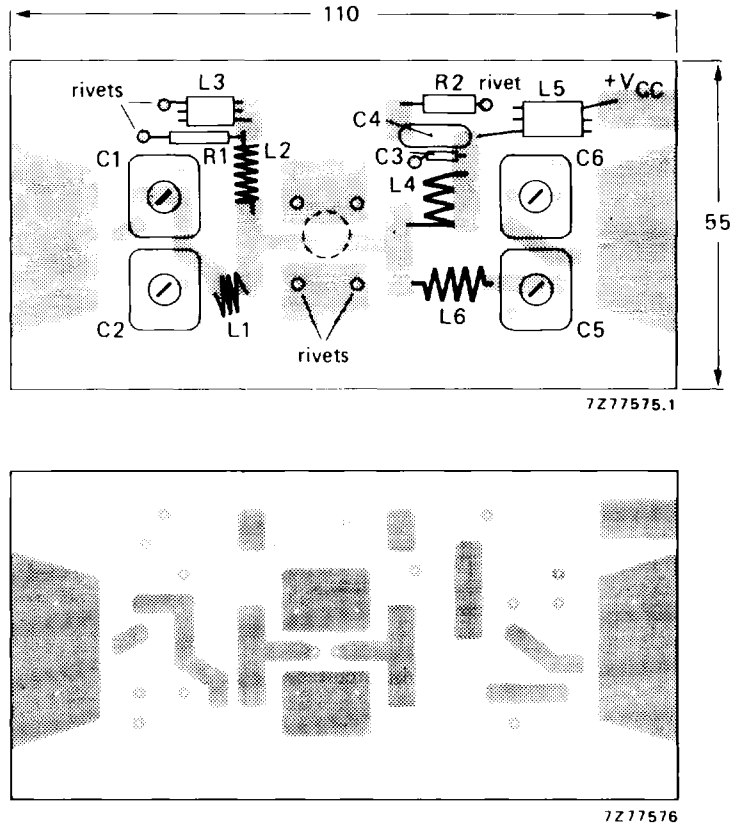

Fig. 8 Component layout and printed-circuit board for 175 MHz test circuit.

The circuit and the components are situated on one side of the epoxy fibre-glass board, the other side being fully metallized to serve as earth. Earth connections are made by means of hollow rivets.

Material of printed-circuit board: 1,6 mm epoxy fibre-glass.

The case is directly grounded on the printed-circuit board.

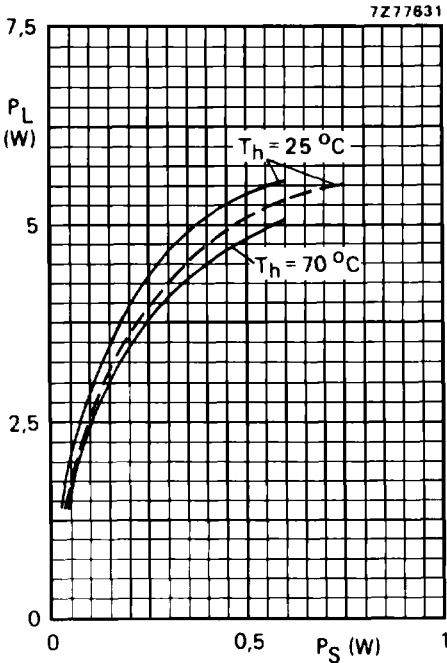

Fig. 9 Typical values; $f = 175\text{ MHz}$;
— $V_{CE} = 13.5\text{ V}$; --- $V_{CE} = 12.5\text{ V}$.

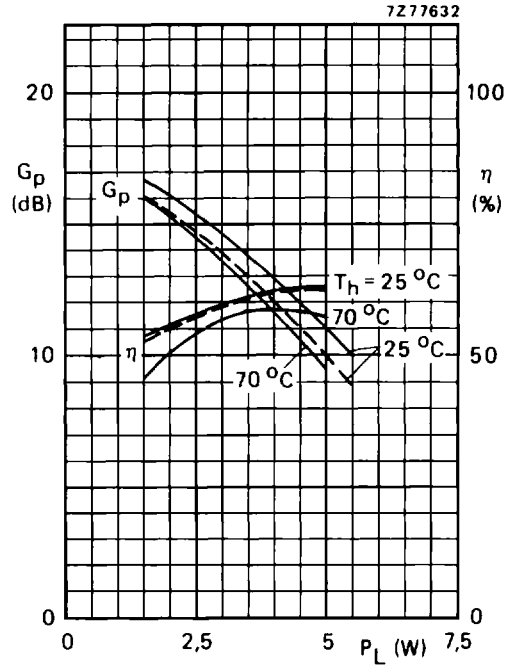

Fig. 10 Typical values; $f = 175\text{ MHz}$;
— $V_{CE} = 13.5\text{ V}$; --- $V_{CE} = 12.5\text{ V}$.

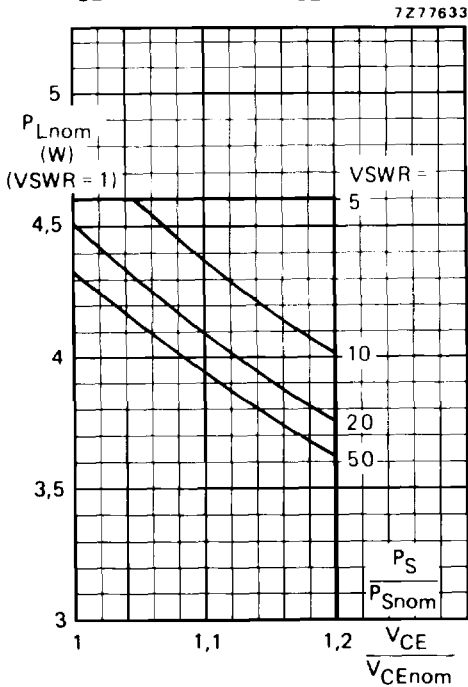

Fig. 11 R.F. SOAR (short-time operation during mismatch); $f = 175\text{ MHz}$; $T_h = 70^\circ\text{C}$.
 $R_{th\text{ mb-h}} = 3\text{ K/W}$; $V_{CEnom} = 13.5\text{ or }12.5\text{ V}$;
 $P_S = P_{Snom}$ at $V_{CE} = V_{CEnom}$ and $VSWR = 1$.

The transistor has been developed for use with unstabilized supply voltages. As the output power and drive power increase with the supply voltage, the nominal output power must be derated in accordance with the graph for safe operation at supply voltages other than the nominal. The graph shows the permissible output power under nominal conditions ($VSWR = 1$), as a function of the expected supply over-voltage ratio with $VSWR$ as parameter.

The graph applies to the situation in which the drive (P_S/P_{Snom}) increases linearly with supply over-voltage ratio.

OPERATING NOTE Below 140 MHz a base-emitter resistor of $10\ \Omega$ is recommended to avoid oscillation. This resistor must be effective for r.f. only.

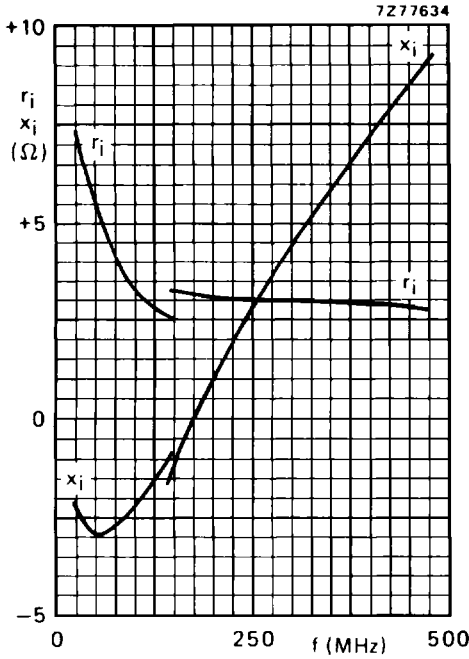

Fig. 12.

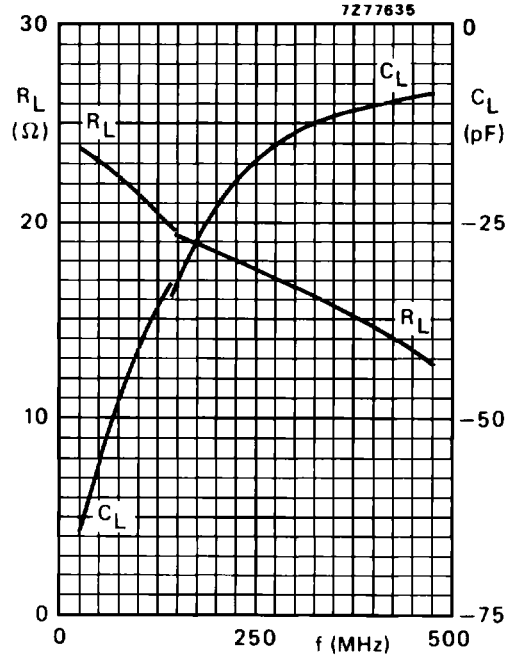
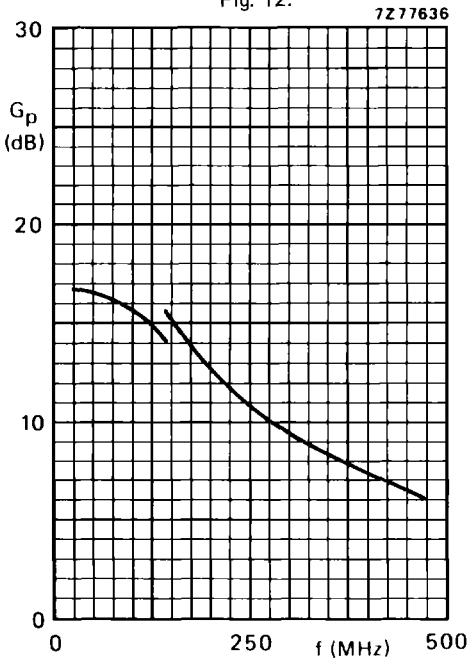

Fig. 13.



Conditions for Figs 12, 13 and 14:
Typical values; $V_{CE} = 13,5\text{ V}$; $P_L = 4\text{ W}$;
 $T_h = 25\text{ }^\circ\text{C}$.

Fig. 14.