

SP5T RF Switch

JSW5-272DR+

50Ω 5 to 2700 MHz High Power 3W

The Big Deal

- High Port count in super small size
- Single Positive Supply Voltage, 2.5 – 4.8V
- High Power P0.1dB, 3W typ.
- Low Insertion Loss, 0.6 dB at 1 GHz

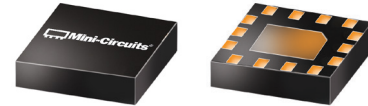

CASE STYLE: MT1817

Product Overview

JSW5-272DR+ is a high power reflective SP5T RF switch, with reflective short on output ports in the off condition. Made using Silicon-on-Insulator process, it has very high IP3, a built-in CMOS driver and negative voltage generator. Its tiny 2x2mm, 14-lead case enables wideband performance in tight spaces and dense PCB layouts.

Key Features

Feature	Advantages
Wideband operation 5-2700 MHz	Enables a single component to be used in a vast array of applications from VHF up to 2.7 GHz.
High IIP3: 55 dBm typ.	Results in little or negligible inter-modulation generation, meeting requirements for digital communication signals.
Low Loss, 0.6 dB at 1 GHz High input power, 3W	Low loss and high power capability enable a single switch to be used for a variety of applications, saving inventory.
Built in negative voltage generator	Operates with a single positive supply voltage; no need for DC blocking capacitors, unless external DC is present at the RF ports.
Built-in CMOS driver	No need for external driver, saving PCB space and cost.
Tiny MCLP package 2 x 2mm, 14-lead	Provides low inductance, repeatable transitions, and excellent thermal contact to PCB.



SP5T RF Switch

50Ω 5-2700 MHz

Reflective RF Switch with internal driver.

Single Supply Voltage, +2.5V to +4.8V, High Power 3W

Product Features

- High Isolation, 37 dB typ. at 1 GHz
- Low insertion loss, 0.6 dB typ. at 1 GHz
- High IP3, 59 dBm typ. at 1 GHz
- Low current consumption, 40 μ A typ.
- High Power, P0.1dB 3W typ.



JSW5-272DR+

CASE STYLE: MT1817

Typical Applications

- CATV systems
- SATCOM system
- Automated Test Stations
- Telecom systems

General Description

JSW5-272DR+ is a high power 3W reflective SP5T switch with integral driver, operates with single positive supply voltage while consuming, 40 μ A typical. It has been designed for very wideband operation of 5-2700 MHz. It is packaged in a tiny 14-lead 2mm x 2mm x 0.55mm package and is rated MSL1 and class 1B ESD.

+RoHS Compliant
The +Suffix identifies RoHS Compliance. See our web site for RoHS Compliance methodologies and qualifications

Simplified Schematic and Pad Description

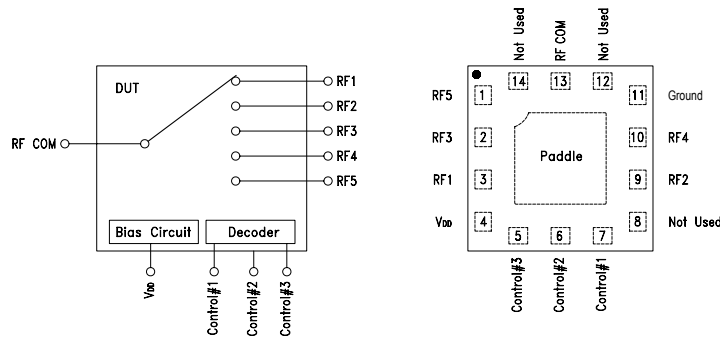

Function	Pad Number	Description
RF COM	13	RF Common/ SUM Port
RF1	3	RF Out #1/In Port #1
RF2	9	RF Out #2/In Port #2
RF3	2	RF Out #3/In Port #3
RF4	10	RF Out #4/In Port #4
RF5	1	RF Out #5/In Port #5
Ground	11	Ground Externally

Function	Pad Number	Description
Control #1	7	Control IN #1
Control #2	6	Control IN #2
Control #3	5	Control IN #3
VDD	4	Supply Voltage
Ground	Paddle	Ground Externally
Not Used	8,12,14	No Connection

RF Electrical Specifications⁽¹⁾, 5 - 2700 MHz, $T_{AMB}=25^{\circ}\text{C}$, $V_{DD}=+2.5$ to 4.8V

Parameter	Condition (MHz)	Min.	Typ.	Max.	Units
Frequency Range		5		2700	MHz
Insertion Loss ⁽²⁾	5 to 1000	—	0.6	0.8	dB
	1000 to 2000	—	0.6	0.8	
	2000 to 2700	—	0.6	0.8	
Isolation between Common Port and RF1 to RF5 Ports ⁽³⁾	5 to 1000	35	37	—	dB
	1000 to 2000	28	30	—	
	2000 to 2700	25	27	—	
Return Loss (ON STATE) RF-COM, RF1 to RF5 Ports	5 to 1000	—	15.5	—	dB
	1000 to 2000	—	14.2	—	
	2000 to 2700	—	14.3	—	
Input IP3	$V_{DD}=2.5$ to 4.8V	5 to 500	—	55	dBm
	$V_{DD}=3.0\text{V}$	1000 to 2700	—	59	
0.1dB Input Compression ⁽⁴⁾	5 to 2700	—	35	—	dBm

DC Electrical Specifications

Parameter	Min.	Typ.	Max.	Units
VDD, Supply Voltage	2.5	3.0	4.8	V
Supply Current ($V_{DD} = 3\text{V}$)		40		μA
Control Voltage Low	0		0.4	V
Control Voltage High ⁽⁵⁾	1.35	1.8	2.7	V
Control Current		0.5	1.0	μA
Shutdown Current at $V_{DD} = 3\text{V}$		5		μA

Notes:

- As measured in Mini-Circuit's test board TB-724-5+ (see Characterization Test Circuit, Fig.1).
- Insertion loss values are de-embedded from test board loss.
- Isolations for other port combinations, see Tables 1 & 2
- Do not exceed RF input power as shown in Absolute Maximum Rating table.
- If $V_{DD} < 2.7\text{V}$, then Max Control Voltage high= V_{DD}

Switching Specifications

Parameter	Min.	Typ.	Max.	Units
Rise/Fall Time (10 to 90% or 90 to 10% RF)	—	0.42 (Rise Time) 0.84 (Fall Time)	—	μSec
Switching Time, 50% CTRL to 90/10% RF	—	1.9 (ON Time) 1.4 (OFF Time)	—	μSec
Video Feedthrough, (control 0 to 1.65V, freq.=10 KHz)	—	3.0	—	mV_{P-P}

Table 1. Isolation Matrix (RF-COM to RF1 to RF5 Ports)

RF Com to Port	Frequency (GHz)	Isolation Typ. (dB)				
		"ON" Port				
		RF1	RF2	RF3	RF4	RF5
RF1	0.01-1.0	---	49	37	53	53
RF1	1.0-2.0	---	43	30	38	38
RF1	2.0-2.7	---	40	28	34	34
RF2	0.01-1.0	48	---	48	48	48
RF2	1.0-2.0	43	---	42	42	42
RF2	2.0-2.7	39	---	38	39	39
RF3	0.01-1.0	39	44	---	38	38
RF3	1.0-2.0	32	38	---	30	30
RF3	2.0-2.7	29	35	---	28	28
RF4	0.01-1.0	44	39	44	---	44
RF4	1.0-2.0	38	31	38	---	39
RF4	2.0-2.7	35	28	35	---	35
RF5	0.01-1.0	44	39	44	44	---
RF5	1.0-2.0	33	34	31	39	---
RF5	2.0-2.7	28	31	27	36	---

Table 2. Isolation Matrix (Between Output Ports)

From Port	Frequency (GHz)	Isolation Typ. (dB)				
		"ON" Port & to Port				
		RF1	RF2	RF3	RF4	RF5
RF1	0.01-1.0	---	52	31	53	32
RF1	1.0-1.5	---	48	28	48	28
RF1	1.5-2.0	---	44	25	45	27
RF2	0.01-1.0	51	---	54	31	52
RF2	1.0-1.5	47	---	49	28	47
RF2	1.5-2.0	43	---	45	25	44
RF3	0.01-1.0	32	54	---	57	31
RF3	1.0-1.5	28	49	---	51	28
RF3	1.5-2.0	26	45	---	48	26
RF4	0.01-1.0	57	32	57	---	56
RF4	1.0-1.5	51	29	51	---	50
RF4	1.5-2.0	46	26	46	---	45
RF5	0.01-1.0	40	49	33	50	---
RF5	1.0-1.5	36	45	30	45	---
RF5	1.5-2.0	34	44	27	43	---

Absolute Maximum Ratings⁽⁶⁾

Parameter	Ratings
Operating Temperature	-40°C to +85°C
Storage Temperature	-55°C to 150°C
V _{DD} , Supply Voltage	5.0V
Voltage Control	-0.5V Min. 3.0 Max.
RF input power ⁽⁶⁾	5 Watt

6. Operation of this device above any of these conditions may cause permanent damage.
 7. Derate linearly to 2.5W at 85°C.

Truth Table⁽⁸⁾ (State of control voltage selects the desired switch state)

State of Control Voltages			RF Common to				
Control #1	Control #2	Control #3	RF1	RF2	RF3	RF4	RF5
L	L	L	ON	—	—	—	—
L	L	H	—	ON	—	—	—
L	H	L	—	—	ON	—	—
L	H	H	—	—	—	ON	—
H	L	L	—	—	—	—	ON
H	H	H	Shutdown				

8. Any control state not defined above, places the switch in an undefined state, but will not damage the switch.

Characterization Test Circuit

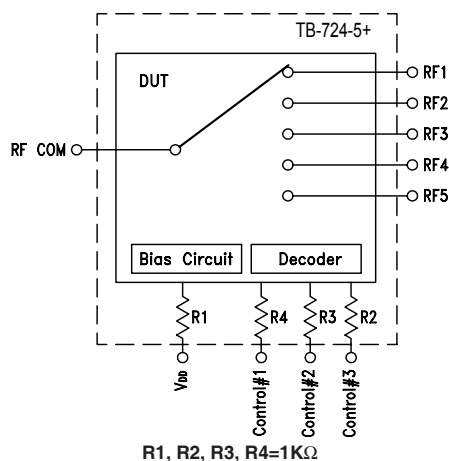

Figure 1: Block Diagram Of Test Circuit Used For Characterization. (DUT soldered on Mini-Circuits' TB-724-5+)

Test Equipment:

- For Insertion loss, Isolation, Return loss:**
Agilent's N5230A Network Analyzer , E3631A power supply.
- For Switching Time and Video Feed through**
Agilent's HP81110A pulse generator, 54833A Oscilloscope, E3631A power supply.
Agilent's N9020A Spectrum Analyzer, E8257D Generator, E3631A power supply
- For Compression:**
R&S Network Analyzer ZVA24, E3631A power supply.

Conditions:

- V_{DD} = +2.5, +3.0 and +4.8V, Control = 0 and 1.35V.
- For Insertion loss, isolation and return loss:** Pin = 0 dBm
- For Input IP3:** Pin = +10dBm/tone at V_{DD} = 3V
- For Switching time:** RF frequency: DC at 200mV, Control Frequency: 10 KHz and 0 and +8V.

Product Marking

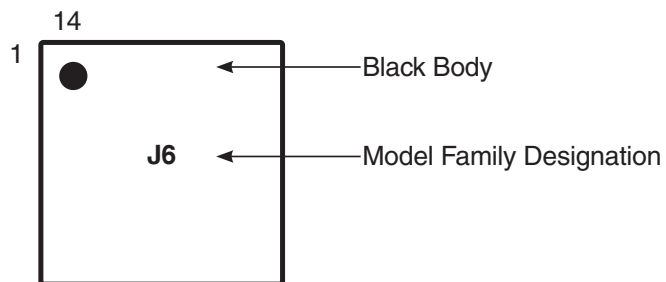

Recommended Application Circuit

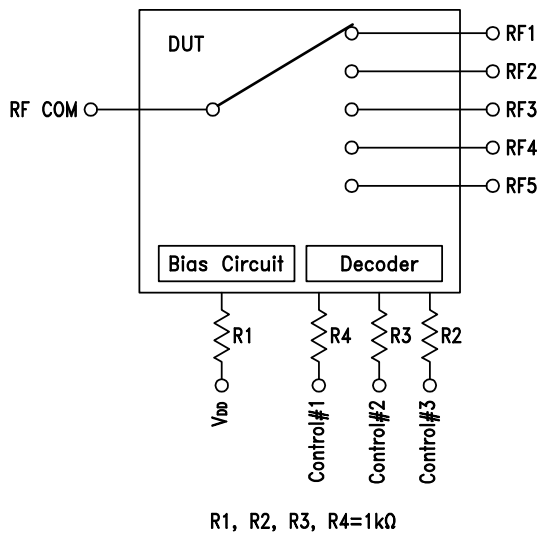

Fig. 2: Evaluation board includes case, connectors and components soldered to PCB.

Additional Detailed Technical Information	
<i>additional information is available on our dash board. To access this information click here</i>	
Performance Data	Data Table
	Swept Graphs
Case Style	MT1817 <i>Plastic package; Lead finish: Matte Tin</i>
Tape & Reel	F108
Standard quantities available on reel	<i>7" reels with 20, 50, 100, 200, 500, 1K or 3K devices</i>
Suggested Layout for PCB Design	PL-463
Evaluation Board	TB-724-5+
Environmental Ratings	ENV75

ESD Rating

Human Body Model (HBM): Class 1B (500 to < 1000V) in accordance with JESD22-A114

Machine Model (MM): Class A (Pass 100V) in accordance with JESD22-A115

MSL Rating

Moisture Sensitivity: MSL1 in accordance with IPC/JEDEC J-STD-020D

MSL Test Flow Chart

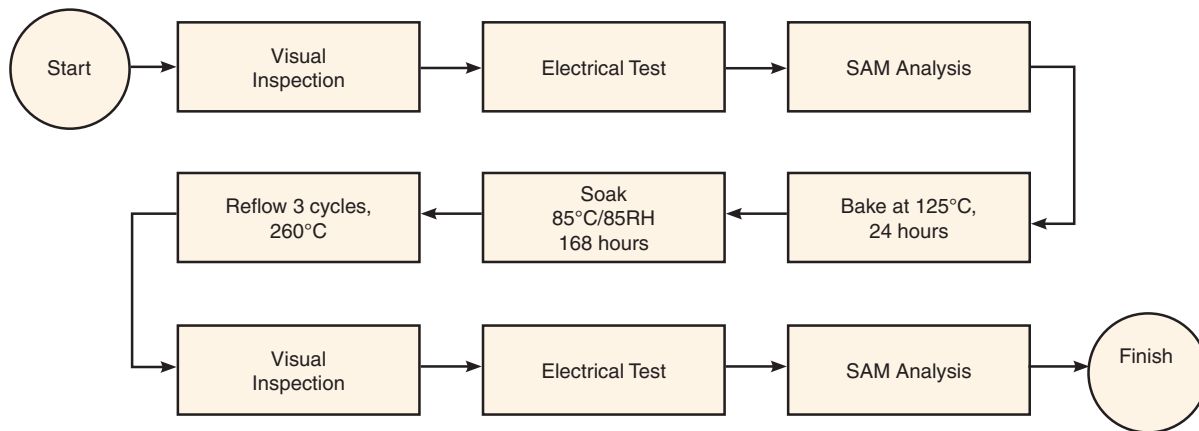

Additional Notes

- A. Performance and quality attributes and conditions not expressly stated in this specification document are intended to be excluded and do not form a part of this specification document.
- B. Electrical specifications and performance data contained in this specification document are based on Mini-Circuit's applicable established test performance criteria and measurement instructions.
- C. The parts covered by this specification document are subject to Mini-Circuits standard limited warranty and terms and conditions (collectively, "Standard Terms"); Purchasers of this part are entitled to the rights and benefits contained therein. For a full statement of the Standard Terms and the exclusive rights and remedies thereunder, please visit Mini-Circuits' website at www.minicircuits.com/MCLStore/terms.jsp

Typical Performance Data

RF FREQ (MHz)	INSERTION LOSS (dB)						RF FREQ (MHz)	ISOLATION (dB)											
	VDD=+2.5V		VDD=+3V		VDD=+4.8V			VDD=+2.5V		VDD=+3V		VDD=+4.8V		VDD=+2.5V		VDD=+3V		VDD=+4.8V	
	RF COM-RF1	RF COM-RF5	RF COM-RF1	RF COM-RF5	RF COM-RF1	RF COM-RF5		RF COM-RF1 (RF2 ON)	RF COM-RF5 (RF4 ON)	RF COM-RF1 (RF2 ON)	RF COM-RF5 (RF4 ON)	RF COM-RF1 (RF2 ON)	RF COM-RF5 (RF4 ON)	RF3-RF4 (RF3 ON)	RF3-RF5 (RF3 ON)	RF3-RF4 (RF3 ON)	RF3-RF5 (RF3 ON)	RF3-RF4 (RF3 ON)	RF3-RF5 (RF3 ON)
10.0	0.40	0.39	0.41	0.39	0.41	0.39	10.0	57.61	60.47	56.08	58.62	62.30	59.10	61.77	53.57	61.12	56.06	62.79	55.22
20.0	0.42	0.42	0.42	0.42	0.42	0.42	20.0	80.10	76.58	100.60	71.92	74.87	73.26	78.23	65.23	88.19	67.59	77.79	65.63
30.0	0.42	0.42	0.42	0.42	0.42	0.42	30.0	82.27	70.92	77.80	71.88	82.69	72.15	78.42	63.89	86.79	63.44	79.48	64.63
40.0	0.42	0.42	0.42	0.42	0.42	0.42	40.0	78.08	68.11	76.16	69.25	82.00	68.76	81.28	61.96	89.47	60.90	85.59	61.55
50.0	0.42	0.41	0.43	0.41	0.42	0.41	50.0	63.00	58.08	60.23	67.10	62.71	58.10	61.07	59.62	62.06	54.84	62.11	68.78
60.0	0.42	0.42	0.42	0.42	0.42	0.41	60.0	74.59	62.56	69.68	71.64	68.23	60.74	68.32	57.14	69.03	55.41	68.21	59.58
70.0	0.42	0.42	0.42	0.42	0.42	0.42	70.0	74.76	63.36	74.42	63.93	73.78	63.19	83.18	56.48	83.82	56.18	86.02	56.68
80.0	0.42	0.42	0.43	0.42	0.42	0.42	80.0	72.32	62.27	71.36	62.35	72.65	62.40	80.20	55.36	81.19	55.40	84.57	55.20
90.0	0.43	0.42	0.43	0.43	0.43	0.42	90.0	70.14	61.08	70.11	61.19	71.48	61.62	84.68	54.23	80.53	54.41	82.01	54.12
100.0	0.43	0.43	0.43	0.43	0.43	0.42	100.0	69.12	60.50	69.72	60.24	70.08	60.71	86.27	53.24	79.86	53.35	79.59	53.22
200.0	0.43	0.43	0.43	0.43	0.43	0.43	200.0	64.53	54.22	63.94	54.37	64.22	54.23	78.32	47.18	76.44	47.20	75.06	47.14
300.0	0.43	0.44	0.43	0.44	0.43	0.44	300.0	60.31	50.43	60.56	50.60	60.07	50.47	72.27	43.61	71.71	43.60	71.74	43.66
400.0	0.43	0.44	0.44	0.44	0.44	0.44	400.0	57.95	48.29	57.78	48.23	57.92	48.26	71.77	41.14	70.17	41.15	70.67	41.12
500.0	0.43	0.45	0.43	0.45	0.43	0.45	500.0	55.98	46.18	55.73	46.11	55.78	46.18	67.83	39.07	68.43	39.08	67.48	39.09
600.0	0.44	0.46	0.44	0.46	0.44	0.46	600.0	54.10	44.40	54.13	44.42	54.20	44.41	66.08	37.49	66.08	37.48	66.32	37.49
700.0	0.44	0.46	0.44	0.46	0.44	0.46	700.0	52.92	43.07	52.92	43.05	53.01	43.06	64.96	36.05	65.11	36.04	64.98	36.03
800.0	0.43	0.46	0.43	0.46	0.43	0.46	800.0	51.83	41.67	51.73	41.66	51.65	41.62	61.68	34.78	61.50	34.79	62.04	34.79
900.0	0.43	0.47	0.44	0.47	0.44	0.47	900.0	50.63	40.82	50.75	40.81	50.72	40.81	59.20	33.79	59.23	33.78	59.11	33.79
1000.0	0.43	0.46	0.43	0.46	0.43	0.46	1000.0	49.80	39.71	49.75	39.72	49.67	39.71	58.38	32.80	58.32	32.81	58.49	32.81
1100.0	0.42	0.46	0.42	0.46	0.42	0.46	1100.0	49.19	38.69	49.14	38.70	49.09	38.73	57.82	31.84	57.97	31.84	58.05	31.84
1200.0	0.42	0.46	0.43	0.46	0.43	0.46	1200.0	48.18	38.03	48.24	38.04	48.21	38.05	55.59	31.05	55.61	31.05	55.69	31.05
1300.0	0.42	0.45	0.42	0.45	0.43	0.45	1300.0	47.68	37.19	47.69	37.20	47.58	37.19	53.39	30.44	53.42	30.44	53.42	30.43
1400.0	0.41	0.45	0.41	0.45	0.41	0.45	1400.0	46.87	36.73	46.92	36.75	46.91	36.75	52.54	29.74	52.52	29.74	52.68	29.74
1500.0	0.41	0.45	0.41	0.45	0.41	0.45	1500.0	46.07	36.13	46.07	36.14	46.09	36.13	51.24	29.22	51.34	29.22	51.40	29.22
1600.0	0.42	0.44	0.42	0.44	0.42	0.44	1600.0	45.93	35.38	45.91	35.36	45.89	35.37	51.03	28.59	51.03	28.58	51.08	28.60
1700.0	0.40	0.44	0.40	0.44	0.41	0.44	1700.0	44.93	35.19	44.93	35.20	45.11	35.21	49.69	28.13	49.71	28.13	49.71	28.14
1800.0	0.40	0.43	0.40	0.43	0.40	0.43	1800.0	44.96	34.58	44.98	34.59	44.99	34.60	48.08	27.86	48.05	27.86	47.99	27.86
1900.0	0.40	0.43	0.40	0.43	0.41	0.44	1900.0	44.23	34.20	44.22	34.18	44.17	34.20	47.84	27.30	47.80	27.30	47.74	27.30
2000.0	0.40	0.44	0.40	0.44	0.40	0.44	2000.0	43.18	34.11	43.24	34.10	43.30	34.11	46.49	27.01	46.47	27.01	46.39	27.02
2100.0	0.37	0.41	0.37	0.41	0.38	0.42	2100.0	43.16	33.30	43.14	33.30	43.17	33.30	46.15	26.42	46.15	26.42	46.16	26.43
2200.0	0.38	0.42	0.38	0.42	0.38	0.42	2200.0	42.15	32.98	42.23	32.97	42.27	32.96	46.28	26.06	46.27	26.06	46.32	26.08
2300.0	0.37	0.41	0.37	0.41	0.38	0.41	2300.0	41.71	32.93	41.73	32.92	41.52	32.91	43.89	25.97	43.89	25.97	43.91	25.99
2400.0	0.35	0.38	0.35	0.38	0.35	0.38	2400.0	41.31	32.14	41.33	32.16	41.46	32.20	44.19	25.19	44.18	25.19	44.33	25.20
2500.0	0.35	0.37	0.35	0.37	0.36	0.37	2500.0	40.93	31.73	40.93	31.73	40.82	31.73	44.19	24.95	44.24	24.95	44.28	24.95
2600.0	0.34	0.36	0.35	0.36	0.35	0.36	2600.0	40.14	31.57	40.15	31.56	40.16	31.57	42.56	24.55	42.57	24.55	42.64	24.53
2700.0	0.34	0.35	0.34	0.36	0.35	0.36	2700.0	39.99	30.77	40.00	30.76	39.85	30.76	43.56	23.96	43.55	23.96	43.46	23.97
2800.0	0.36	0.38	0.36	0.38	0.36	0.38	2800.0	39.34	30.72	39.32	30.71	39.22	30.73	42.79	23.92	42.77	23.93	42.72	23.93



P.O. Box 350166, Brooklyn, New York 11235-0003 (718) 934-4500 • Fax (718) 332-4661 For detailed performance specs & shopping online see Mini-Circuits web site

The Design Engineers Search Engine Provides ACTUAL Data Instantly From MINI-CIRCUITS At: www.minicircuits.com

IF/RF MICROWAVE COMPONENTS

Typical Performance Data

RF FREQ (MHz)	VSWR (:1) (ON STATE)												RF FREQ (MHz)	VSWR (:1) (OFF STATE)					
	VDD=+2.5V				VDD=+3V				VDD=+4.8V					VDD=+2.5V		VDD=+3V		VDD=+4.8V	
	RF COM		RF1	RF5	RF COM		RF1	RF5	RF COM		RF1	RF5		RF1	RF5	RF1	RF5		
	(RF1 ON)	(RF5 ON)	(RF1 ON)	(RF5 ON)	(RF1 ON)	(RF5 ON)	(RF1 ON)	(RF5 ON)	(RF1 ON)	(RF5 ON)	(RF1 ON)	(RF5 ON)		(RF2 ON)	(RF2 ON)	(RF2 ON)	(RF2 ON)	(RF2 ON)	(RF2 ON)
10.0	1.07	1.06	1.07	1.06	1.06	1.06	1.07	1.06	1.07	1.06	1.07	1.06	10.0	3.37	3.38	3.37	3.37	3.36	3.36
20.0	1.06	1.06	1.06	1.06	1.06	1.06	1.06	1.06	1.06	1.06	1.06	1.06	20.0	3.35	3.35	3.35	3.35	3.34	3.34
30.0	1.06	1.06	1.06	1.06	1.06	1.06	1.06	1.06	1.06	1.06	1.06	1.07	30.0	3.35	3.35	3.35	3.35	3.34	3.34
40.0	1.06	1.06	1.06	1.06	1.06	1.06	1.06	1.06	1.06	1.06	1.06	1.07	40.0	3.35	3.35	3.35	3.35	3.34	3.34
50.0	1.07	1.07	1.06	1.07	1.06	1.06	1.06	1.07	1.07	1.07	1.06	1.07	50.0	3.35	3.35	3.35	3.35	3.34	3.34
60.0	1.07	1.07	1.06	1.06	1.07	1.07	1.06	1.06	1.07	1.07	1.06	1.06	60.0	3.35	3.35	3.35	3.35	3.34	3.34
70.0	1.07	1.07	1.06	1.07	1.07	1.07	1.06	1.07	1.07	1.07	1.06	1.07	70.0	3.34	3.35	3.34	3.35	3.33	3.34
80.0	1.07	1.07	1.06	1.07	1.07	1.07	1.06	1.07	1.07	1.07	1.06	1.07	80.0	3.34	3.35	3.34	3.35	3.33	3.33
90.0	1.07	1.07	1.06	1.07	1.07	1.07	1.06	1.07	1.07	1.07	1.06	1.07	90.0	3.34	3.34	3.34	3.34	3.33	3.33
100.0	1.07	1.07	1.06	1.07	1.07	1.07	1.06	1.07	1.07	1.07	1.06	1.07	100.0	3.34	3.34	3.34	3.34	3.33	3.33
200.0	1.07	1.07	1.07	1.09	1.07	1.07	1.07	1.08	1.07	1.07	1.07	1.09	200.0	3.33	3.31	3.33	3.31	3.31	3.30
300.0	1.08	1.10	1.08	1.12	1.08	1.10	1.08	1.12	1.08	1.10	1.08	1.12	300.0	3.31	3.27	3.31	3.27	3.30	3.26
400.0	1.10	1.11	1.07	1.13	1.10	1.11	1.07	1.13	1.10	1.11	1.07	1.13	400.0	3.31	3.23	3.31	3.23	3.30	3.21
500.0	1.09	1.12	1.08	1.16	1.09	1.11	1.08	1.16	1.10	1.12	1.08	1.16	500.0	3.30	3.18	3.30	3.18	3.29	3.16
600.0	1.12	1.14	1.09	1.19	1.12	1.15	1.10	1.19	1.12	1.15	1.10	1.19	600.0	3.27	3.12	3.27	3.12	3.26	3.11
700.0	1.13	1.14	1.08	1.18	1.13	1.14	1.08	1.18	1.13	1.14	1.08	1.18	700.0	3.26	3.08	3.26	3.08	3.25	3.06
800.0	1.10	1.13	1.08	1.20	1.10	1.13	1.09	1.20	1.11	1.13	1.09	1.20	800.0	3.25	3.02	3.25	3.03	3.23	3.01
900.0	1.12	1.15	1.09	1.22	1.12	1.16	1.09	1.21	1.13	1.16	1.09	1.21	900.0	3.21	2.97	3.22	2.97	3.21	2.96
1000.0	1.12	1.13	1.06	1.19	1.12	1.13	1.06	1.19	1.12	1.13	1.06	1.19	1000.0	3.22	2.94	3.22	2.94	3.20	2.91
1100.0	1.09	1.11	1.06	1.21	1.09	1.10	1.06	1.20	1.09	1.10	1.06	1.21	1100.0	3.22	2.89	3.21	2.89	3.20	2.88
1200.0	1.12	1.13	1.07	1.21	1.12	1.13	1.07	1.21	1.12	1.13	1.07	1.21	1200.0	3.20	2.86	3.21	2.86	3.20	2.85
1300.0	1.13	1.08	1.03	1.16	1.13	1.08	1.03	1.16	1.13	1.08	1.03	1.16	1300.0	3.20	2.84	3.20	2.84	3.18	2.81
1400.0	1.08	1.04	1.04	1.18	1.08	1.04	1.04	1.18	1.08	1.04	1.04	1.18	1400.0	3.20	2.83	3.20	2.83	3.19	2.82
1500.0	1.10	1.06	1.03	1.18	1.10	1.06	1.03	1.18	1.10	1.06	1.03	1.17	1500.0	3.22	2.84	3.22	2.84	3.21	2.84
1600.0	1.15	1.04	1.04	1.12	1.15	1.04	1.03	1.12	1.15	1.04	1.03	1.13	1600.0	3.22	2.87	3.22	2.87	3.20	2.85
1700.0	1.12	1.08	1.08	1.18	1.12	1.08	1.08	1.18	1.13	1.08	1.09	1.17	1700.0	3.23	2.92	3.24	2.93	3.23	2.91
1800.0	1.10	1.04	1.05	1.17	1.10	1.04	1.05	1.17	1.10	1.04	1.05	1.16	1800.0	3.29	2.97	3.29	2.98	3.27	2.98
1900.0	1.17	1.12	1.09	1.16	1.17	1.12	1.09	1.16	1.17	1.12	1.09	1.17	1900.0	3.29	3.06	3.30	3.06	3.29	3.03
2000.0	1.18	1.18	1.15	1.23	1.18	1.19	1.15	1.23	1.18	1.18	1.15	1.23	2000.0	3.34	3.16	3.34	3.16	3.33	3.14
2100.0	1.10	1.12	1.10	1.20	1.10	1.11	1.10	1.20	1.09	1.11	1.10	1.20	2100.0	3.42	3.24	3.41	3.24	3.39	3.25
2200.0	1.16	1.16	1.10	1.18	1.16	1.16	1.11	1.19	1.16	1.16	1.11	1.19	2200.0	3.40	3.33	3.42	3.33	3.41	3.30
2300.0	1.16	1.20	1.15	1.23	1.16	1.20	1.16	1.23	1.16	1.20	1.16	1.22	2300.0	3.47	3.45	3.45	3.46	3.43	3.43
2400.0	1.05	1.09	1.12	1.16	1.06	1.09	1.12	1.16	1.05	1.09	1.11	1.16	2400.0	3.49	3.56	3.50	3.56	3.48	3.57
2500.0	1.06	1.08	1.07	1.09	1.06	1.08	1.07	1.09	1.06	1.08	1.07	1.10	2500.0	3.47	3.62	3.48	3.62	3.45	3.58
2600.0	1.07	1.08	1.12	1.12	1.07	1.09	1.12	1.11	1.07	1.08	1.12	1.11	2600.0	3.52	3.70	3.51	3.71	3.49	3.67
2700.0	1.08	1.06	1.15	1.11	1.08	1.07	1.14	1.11	1.08	1.06	1.14	1.11	2700.0	3.54	3.73	3.56	3.73	3.54	3.74
2800.0	1.11	1.15	1.11	1.11	1.11	1.15	1.11	1.11	1.11	1.15	1.12	1.11	2800.0	3.54	3.71	3.52	3.70	3.50	3.67



P.O. Box 350166, Brooklyn, New York 11235-0003 (718) 934-4500 • Fax (718) 332-4661 For detailed performance specs & shopping online see Mini-Circuits web site



The Design Engineers Search Engine Provides ACTUAL Data Instantly From MINI-CIRCUITS At: www.minicircuits.com

IF/RF MICROWAVE COMPONENTS

REV. OR
JSW5-272DR+
11/11/2015
Page 2 of 9

Typical Performance Data

RF FREQ (MHz)	INPUT IP3 (dBm)		RF FREQ (MHz)	COMPRESSION (dB) @ FIXED POWER FOR PIN=34.5dBm	
	VDD=+3V			VDD=+3V	
	RF COM-RF1	RF COM-RF5		RF COM-RF1	RF COM-RF5
10.1	55.53	56.03	10.0	-0.03	0.02
250.1	58.87	58.46	20.0	0.08	0.08
500.1	54.96	54.75	30.0	-0.05	0.03
1000.1	66.99	64.33	40.0	-0.02	0.00
1500.1	61.74	62.91	50.0	0.03	0.04
2000.1	61.54	62.23	60.0	0.01	0.02
2500.1	59.45	60.43	70.0	0.01	0.01
3000.1	61.24	60.04	80.0	0.00	0.03
			90.0	0.01	0.01
			100.0	0.00	0.01
			200.0	0.01	0.00
			300.0	0.00	0.01
			400.0	0.01	0.00
			500.0	0.00	0.00
			600.0	0.00	0.00
			700.0	-0.01	0.00
			800.0	-0.01	-0.01
			900.0	-0.02	0.00
			1000.0	-0.01	-0.02
			1100.0	-0.01	-0.01
			1200.0	-0.01	-0.03
			1300.0	-0.01	-0.02
			1400.0	-0.01	-0.02
			1500.0	-0.02	-0.02
			1600.0	-0.01	-0.02
			1700.0	-0.02	-0.02
			1800.0	-0.02	-0.02
			1900.0	0.00	-0.01
			2000.0	-0.01	-0.01
			2100.0	-0.01	-0.01
			2200.0	0.00	-0.02
			2300.0	0.00	-0.02
			2400.0	0.00	-0.01
			2500.0	0.00	-0.01
			2600.0	0.01	-0.01
			2700.0	0.01	0.01
			2800.0	0.01	0.01

Typical Performance Data

RF FREQ (MHz)	INSERTION LOSS (dB) @ VDD=+3V OVER TEMPERATURE						RF FREQ (MHz)	ISOLATION (dB) @ VDD=+3V OVER TEMPERATURE											
	RF COM-RF1			RF COM-RF5				RF COM-RF1 (RF2 ON)			RF COM-RF5 (RF4 ON)			RF3-RF4 (RF3 ON)			RF3-RF5 (RF3 ON)		
	-45°C	+25°C	+90°C	-45°C	+25°C	+90°C		-45°C	+25°C	+90°C	-45°C	+25°C	+90°C	-45°C	+25°C	+90°C	-45°C	+25°C	+90°C
10.0	0.31	0.41	0.48	0.31	0.39	0.47	10.0	61.53	56.08	56.20	63.70	58.62	56.75	59.55	61.12	56.02	58.43	56.06	59.04
20.0	0.33	0.42	0.50	0.34	0.42	0.50	20.0	80.56	100.60	83.18	72.63	71.92	72.89	85.00	88.19	84.61	66.63	67.59	66.61
30.0	0.33	0.42	0.50	0.34	0.42	0.50	30.0	95.14	77.80	78.13	73.94	71.88	72.78	80.60	86.79	83.74	64.57	63.44	63.05
40.0	0.33	0.42	0.50	0.34	0.42	0.50	40.0	80.15	76.16	74.29	68.68	69.25	68.09	83.01	89.47	81.96	60.76	60.90	60.28
50.0	0.34	0.43	0.50	0.34	0.41	0.49	50.0	61.71	60.23	59.63	64.18	67.10	61.98	62.10	62.06	61.03	56.32	54.84	56.21
60.0	0.34	0.42	0.50	0.34	0.42	0.49	60.0	73.60	69.68	65.74	73.83	71.64	62.06	72.26	69.03	67.93	58.21	55.41	58.05
70.0	0.34	0.42	0.50	0.35	0.42	0.50	70.0	78.65	74.42	71.47	63.86	63.93	63.44	78.83	83.82	90.55	56.77	56.18	56.11
80.0	0.35	0.43	0.50	0.35	0.42	0.50	80.0	73.84	71.36	69.73	62.54	62.35	62.47	76.72	81.19	91.36	55.52	55.40	54.82
90.0	0.35	0.43	0.50	0.35	0.43	0.50	90.0	72.17	70.11	69.55	61.23	61.19	61.46	74.63	80.53	83.68	54.44	54.41	53.98
100.0	0.35	0.43	0.50	0.36	0.43	0.50	100.0	71.17	69.72	69.19	60.42	60.24	60.21	76.25	79.86	87.30	53.75	53.35	53.08
200.0	0.35	0.43	0.51	0.35	0.43	0.51	200.0	65.94	63.94	62.68	54.33	54.37	54.16	70.42	76.44	94.73	47.47	47.20	46.95
300.0	0.36	0.43	0.53	0.35	0.44	0.53	300.0	62.27	60.56	59.31	50.59	50.60	50.60	68.23	71.71	75.94	43.96	43.60	43.47
400.0	0.37	0.44	0.54	0.35	0.44	0.55	400.0	59.07	57.78	56.66	48.31	48.23	48.11	65.20	70.17	75.78	41.34	41.15	40.86
500.0	0.38	0.43	0.54	0.34	0.45	0.56	500.0	57.00	55.73	54.57	46.16	46.11	46.06	63.38	68.43	72.59	39.28	39.08	38.92
600.0	0.40	0.44	0.56	0.34	0.46	0.58	600.0	55.37	54.13	53.01	44.37	44.42	44.38	61.76	66.08	69.77	37.66	37.48	37.23
700.0	0.40	0.44	0.56	0.34	0.46	0.59	700.0	53.90	52.92	51.93	43.01	43.05	43.04	60.46	65.11	69.68	36.16	36.04	35.85
800.0	0.39	0.43	0.56	0.33	0.46	0.59	800.0	52.68	51.73	50.69	41.58	41.66	41.70	57.87	61.50	65.80	34.88	34.79	34.66
900.0	0.41	0.44	0.57	0.33	0.47	0.61	900.0	51.71	50.75	49.72	40.76	40.81	40.77	56.21	59.23	62.16	33.90	33.78	33.62
1000.0	0.39	0.43	0.58	0.32	0.46	0.61	1000.0	50.60	49.75	48.67	39.64	39.72	39.76	55.71	58.32	60.39	32.90	32.81	32.65
1100.0	0.37	0.42	0.57	0.31	0.46	0.61	1100.0	50.12	49.14	48.19	38.54	38.70	38.82	54.89	57.97	60.23	31.87	31.84	31.75
1200.0	0.37	0.43	0.58	0.31	0.46	0.62	1200.0	49.15	48.24	47.26	37.92	38.04	38.13	52.90	55.61	58.19	31.07	31.05	31.00
1300.0	0.37	0.42	0.59	0.29	0.45	0.62	1300.0	48.57	47.69	46.56	37.05	37.20	37.34	51.35	53.42	55.25	30.43	30.44	30.37
1400.0	0.34	0.41	0.58	0.28	0.45	0.62	1400.0	47.89	46.92	45.92	36.60	36.75	36.86	50.66	52.52	54.10	29.73	29.74	29.72
1500.0	0.33	0.41	0.58	0.27	0.45	0.62	1500.0	46.92	46.07	45.24	35.94	36.14	36.28	49.56	51.34	52.69	29.21	29.22	29.20
1600.0	0.34	0.42	0.60	0.26	0.44	0.62	1600.0	46.85	45.91	44.83	35.18	35.36	35.56	49.37	51.03	52.06	28.55	28.58	28.58
1700.0	0.33	0.40	0.59	0.25	0.44	0.62	1700.0	45.97	44.93	44.21	35.04	35.20	35.37	48.03	49.71	51.10	28.09	28.13	28.16
1800.0	0.32	0.40	0.58	0.24	0.43	0.62	1800.0	45.98	44.98	43.98	34.40	34.59	34.71	46.63	48.05	49.04	27.87	27.86	27.79
1900.0	0.35	0.40	0.60	0.24	0.43	0.63	1900.0	45.20	44.22	43.26	34.04	34.18	34.36	46.50	47.80	48.81	27.26	27.30	27.26
2000.0	0.34	0.40	0.59	0.24	0.44	0.63	2000.0	43.96	43.24	42.37	34.01	34.10	34.18	45.32	46.47	47.20	27.02	27.01	26.95
2100.0	0.30	0.37	0.57	0.22	0.41	0.61	2100.0	44.17	43.14	42.27	33.15	33.30	33.42	45.26	46.15	46.71	26.41	26.42	26.38
2200.0	0.32	0.38	0.59	0.22	0.42	0.62	2200.0	43.16	42.23	41.24	32.83	32.97	33.05	45.02	46.27	47.38	26.03	26.06	26.01
2300.0	0.30	0.37	0.58	0.22	0.41	0.61	2300.0	42.28	41.73	40.70	32.80	32.92	32.93	43.12	43.89	44.60	26.03	25.97	25.85
2400.0	0.24	0.35	0.57	0.18	0.38	0.59	2400.0	42.31	41.33	40.54	32.08	32.16	32.26	43.63	44.18	44.69	25.22	25.19	25.15
2500.0	0.23	0.35	0.57	0.16	0.37	0.59	2500.0	41.65	40.93	40.10	31.62	31.73	31.80	43.30	44.24	44.86	24.95	24.95	24.90
2600.0	0.22	0.35	0.57	0.15	0.36	0.59	2600.0	40.77	40.15	39.53	31.49	31.56	31.61	41.92	42.57	42.98	24.49	24.55	24.48
2700.0	0.19	0.34	0.58	0.13	0.36	0.60	2700.0	40.57	40.00	39.29	30.61	30.76	30.88	42.70	43.55	43.95	23.96	23.96	23.96
2800.0	0.20	0.36	0.61	0.14	0.38	0.63	2800.0	39.88	39.32	38.70	30.59	30.71	30.80	41.75	42.77	43.51	23.89	23.93	23.90



P.O. Box 350166, Brooklyn, New York 11235-0003 (718) 934-4500 • Fax (718) 332-4661 For detailed performance specs & shopping online see Mini-Circuits web site www.minicircuits.com



The Design Engineers Search Engine Provides ACTUAL Data Instantly From MINI-CIRCUITS At: www.minicircuits.com

IF/RF MICROWAVE COMPONENTS

REV. OR
JSW5-272DR+
11/11/2015
Page 4 of 9

Typical Performance Data

RF FREQ (MHz)	VSWR (:1) @ VDD=+3V OVER TEMPERATURE (ON STATE)												RF FREQ (MHz)	VSWR (:1) @ VDD=+3V OVER TEMPERATURE (OFF STATE)					
	RF COM						RF1			RF5				RF1			RF5		
	(RF1 ON)			(RF5 ON)			(RF1 ON)			(RF5 ON)				(RF2 ON)			(RF2 ON)		
	-45°C	+25°C	+90°C	-45°C	+25°C	+90°C	-45°C	+25°C	+90°C	-45°C	+25°C	+90°C		-45°C	+25°C	+90°C	-45°C	+25°C	+90°C
10.0	1.06	1.06	1.08	1.05	1.06	1.08	1.06	1.07	1.08	1.05	1.06	1.08	10.0	4.31	3.37	2.67	4.34	3.37	2.66
20.0	1.05	1.06	1.08	1.05	1.06	1.08	1.05	1.06	1.08	1.05	1.06	1.08	20.0	4.27	3.35	2.66	4.30	3.35	2.65
30.0	1.05	1.06	1.08	1.05	1.06	1.08	1.05	1.06	1.08	1.05	1.06	1.08	30.0	4.27	3.35	2.66	4.29	3.35	2.65
40.0	1.05	1.06	1.08	1.05	1.06	1.08	1.05	1.06	1.08	1.05	1.06	1.08	40.0	4.27	3.35	2.66	4.29	3.35	2.65
50.0	1.05	1.06	1.09	1.05	1.06	1.08	1.05	1.06	1.08	1.05	1.07	1.08	50.0	4.26	3.35	2.66	4.29	3.35	2.65
60.0	1.05	1.07	1.09	1.06	1.07	1.09	1.05	1.06	1.08	1.05	1.06	1.08	60.0	4.26	3.35	2.66	4.28	3.35	2.65
70.0	1.05	1.07	1.09	1.05	1.07	1.08	1.05	1.06	1.08	1.05	1.07	1.08	70.0	4.25	3.34	2.66	4.28	3.35	2.65
80.0	1.05	1.07	1.08	1.05	1.07	1.08	1.05	1.06	1.08	1.06	1.07	1.08	80.0	4.25	3.34	2.66	4.27	3.35	2.65
90.0	1.05	1.07	1.09	1.05	1.07	1.09	1.05	1.06	1.08	1.06	1.07	1.08	90.0	4.24	3.34	2.66	4.26	3.34	2.65
100.0	1.05	1.07	1.09	1.06	1.07	1.09	1.04	1.06	1.08	1.05	1.07	1.08	100.0	4.24	3.34	2.67	4.26	3.34	2.66
200.0	1.05	1.07	1.08	1.05	1.07	1.09	1.05	1.07	1.09	1.06	1.08	1.11	200.0	4.22	3.33	2.66	4.23	3.31	2.63
300.0	1.06	1.08	1.10	1.08	1.10	1.12	1.06	1.08	1.10	1.10	1.12	1.14	300.0	4.23	3.31	2.63	4.20	3.27	2.58
400.0	1.08	1.10	1.12	1.10	1.11	1.13	1.05	1.07	1.09	1.12	1.13	1.15	400.0	4.23	3.31	2.63	4.14	3.23	2.55
500.0	1.08	1.09	1.11	1.10	1.11	1.13	1.07	1.08	1.10	1.14	1.16	1.18	500.0	4.22	3.30	2.61	4.09	3.18	2.51
600.0	1.10	1.12	1.14	1.13	1.15	1.16	1.08	1.10	1.12	1.17	1.19	1.21	600.0	4.20	3.27	2.58	4.05	3.12	2.44
700.0	1.11	1.13	1.14	1.14	1.14	1.15	1.06	1.08	1.09	1.17	1.18	1.19	700.0	4.21	3.26	2.56	4.00	3.08	2.41
800.0	1.09	1.10	1.12	1.13	1.13	1.13	1.07	1.09	1.10	1.18	1.20	1.21	800.0	4.19	3.25	2.56	3.92	3.03	2.37
900.0	1.10	1.12	1.14	1.15	1.16	1.16	1.08	1.09	1.11	1.20	1.21	1.24	900.0	4.16	3.22	2.53	3.89	2.97	2.31
1000.0	1.10	1.12	1.14	1.13	1.13	1.12	1.05	1.06	1.07	1.18	1.19	1.19	1000.0	4.19	3.22	2.51	3.84	2.94	2.29
1100.0	1.08	1.09	1.10	1.12	1.10	1.08	1.06	1.06	1.07	1.19	1.20	1.21	1100.0	4.18	3.21	2.53	3.77	2.89	2.26
1200.0	1.11	1.12	1.13	1.15	1.13	1.11	1.07	1.07	1.07	1.20	1.21	1.23	1200.0	4.17	3.21	2.53	3.75	2.86	2.23
1300.0	1.12	1.13	1.15	1.09	1.08	1.07	1.04	1.03	1.03	1.15	1.16	1.16	1300.0	4.17	3.20	2.51	3.72	2.84	2.23
1400.0	1.06	1.08	1.11	1.07	1.04	1.01	1.02	1.04	1.07	1.16	1.18	1.19	1400.0	4.17	3.20	2.52	3.69	2.83	2.24
1500.0	1.09	1.10	1.11	1.09	1.06	1.04	1.03	1.03	1.04	1.16	1.18	1.20	1500.0	4.19	3.22	2.56	3.69	2.84	2.24
1600.0	1.14	1.15	1.17	1.01	1.04	1.06	1.05	1.03	1.03	1.10	1.12	1.14	1600.0	4.19	3.22	2.55	3.73	2.87	2.29
1700.0	1.10	1.12	1.14	1.07	1.08	1.09	1.07	1.08	1.11	1.16	1.18	1.19	1700.0	4.22	3.24	2.56	3.79	2.93	2.35
1800.0	1.08	1.10	1.10	1.04	1.04	1.04	1.04	1.05	1.06	1.15	1.17	1.18	1800.0	4.24	3.29	2.62	3.82	2.98	2.38
1900.0	1.17	1.17	1.18	1.11	1.12	1.13	1.10	1.09	1.08	1.15	1.16	1.16	1900.0	4.27	3.30	2.62	3.96	3.06	2.45
2000.0	1.17	1.18	1.17	1.18	1.19	1.17	1.15	1.15	1.14	1.23	1.23	1.23	2000.0	4.34	3.34	2.65	4.07	3.16	2.52
2100.0	1.09	1.10	1.09	1.12	1.11	1.10	1.10	1.10	1.09	1.20	1.20	1.19	2100.0	4.40	3.41	2.71	4.16	3.24	2.57
2200.0	1.16	1.16	1.15	1.17	1.16	1.15	1.12	1.11	1.08	1.20	1.19	1.15	2200.0	4.42	3.42	2.70	4.36	3.33	2.65
2300.0	1.17	1.16	1.14	1.23	1.20	1.16	1.17	1.16	1.13	1.26	1.23	1.20	2300.0	4.51	3.45	2.74	4.48	3.46	2.74
2400.0	1.07	1.06	1.03	1.11	1.09	1.05	1.12	1.12	1.11	1.18	1.16	1.14	2400.0	4.54	3.50	2.76	4.67	3.56	2.77
2500.0	1.07	1.06	1.07	1.09	1.08	1.08	1.08	1.07	1.06	1.11	1.09	1.07	2500.0	4.53	3.48	2.74	4.84	3.62	2.81
2600.0	1.09	1.07	1.05	1.11	1.09	1.06	1.13	1.12	1.11	1.14	1.11	1.10	2600.0	4.62	3.51	2.76	4.87	3.71	2.86
2700.0	1.09	1.08	1.08	1.05	1.07	1.08	1.13	1.14	1.15	1.09	1.11	1.14	2700.0	4.67	3.56	2.76	5.00	3.73	2.84
2800.0	1.09	1.11	1.13	1.13	1.15	1.17	1.09	1.11	1.13	1.09	1.11	1.13	2800.0	4.63	3.52	2.73	5.09	3.70	2.84



P.O. Box 350166, Brooklyn, New York 11235-0003 (718) 934-4500 • Fax (718) 332-4661 For detailed performance specs & shopping online see Mini-Circuits web site JSW5-272DR+

The Design Engineers Search Engine Provides ACTUAL Data Instantly From MINI-CIRCUITS At: www.minicircuits.com

IF/RF MICROWAVE COMPONENTS

Typical Performance Data

RF FREQ (MHz)	INSERTION LOSS (dB) @ VDD=+2.5V OVER TEMPERATURE						RF FREQ (MHz)	ISOLATION (dB) @ VDD=+2.5V OVER TEMPERATURE											
	RF COM-RF1			RF COM-RF6				RF COM-RF1 (RF2 ON)			RF COM-RF5 (RF4 ON)			RF3-RF4 (RF3 ON)			RF3-RF5 (RF3 ON)		
	-45°C	+25°C	+90°C	-45°C	+25°C	+90°C		-45°C	+25°C	+90°C	-45°C	+25°C	+90°C	-45°C	+25°C	+90°C	-45°C	+25°C	+90°C
10.0	0.33	0.40	0.49	0.31	0.39	0.47	10.0	56.13	57.61	54.61	56.29	60.47	56.00	55.79	61.77	60.26	57.91	53.57	55.92
20.0	0.34	0.42	0.50	0.34	0.42	0.50	20.0	81.02	80.10	80.84	73.20	76.58	72.99	74.42	78.23	89.40	67.65	65.23	67.56
30.0	0.34	0.42	0.50	0.34	0.42	0.50	30.0	81.80	82.27	82.78	72.51	70.92	71.62	78.75	78.42	90.20	63.67	63.89	63.43
40.0	0.35	0.42	0.50	0.34	0.42	0.50	40.0	80.27	78.08	76.71	68.65	68.11	68.79	82.02	81.28	94.78	60.89	61.96	60.55
50.0	0.35	0.42	0.50	0.34	0.41	0.49	50.0	60.16	63.00	59.86	64.57	58.08	58.63	61.48	61.07	61.47	54.73	59.62	54.32
60.0	0.35	0.42	0.50	0.34	0.42	0.49	60.0	67.18	74.59	65.32	73.37	62.56	60.82	66.79	68.32	68.32	56.63	57.14	55.96
70.0	0.35	0.42	0.50	0.35	0.42	0.50	70.0	73.57	74.76	71.60	63.97	63.36	63.20	77.92	83.18	91.17	56.65	56.48	55.99
80.0	0.35	0.42	0.50	0.35	0.42	0.50	80.0	74.20	72.32	70.60	62.41	62.27	62.51	80.47	80.20	87.40	55.63	55.36	55.02
90.0	0.36	0.43	0.51	0.35	0.42	0.50	90.0	72.64	70.14	70.42	61.35	61.08	61.53	78.17	84.68	94.18	54.72	54.23	54.13
100.0	0.36	0.43	0.51	0.35	0.43	0.51	100.0	73.03	69.12	70.20	60.44	60.50	60.50	74.92	86.27	93.53	53.74	53.24	53.11
200.0	0.35	0.43	0.51	0.35	0.43	0.51	200.0	65.17	64.53	62.73	54.28	54.22	54.21	70.59	78.32	98.54	47.47	47.18	46.97
300.0	0.35	0.43	0.53	0.35	0.44	0.53	300.0	61.61	60.31	59.08	50.60	50.43	50.51	66.61	72.27	77.24	43.87	43.61	43.37
400.0	0.34	0.43	0.54	0.35	0.44	0.55	400.0	59.00	57.95	56.56	48.26	48.29	48.18	65.73	71.77	76.11	41.35	41.14	40.89
500.0	0.33	0.43	0.54	0.34	0.45	0.56	500.0	56.80	55.98	54.53	46.16	46.18	46.10	62.91	67.83	72.46	39.26	39.07	38.86
600.0	0.33	0.44	0.56	0.34	0.46	0.58	600.0	55.21	54.10	53.07	44.38	44.40	44.38	62.16	66.08	70.13	37.66	37.49	37.24
700.0	0.32	0.44	0.57	0.33	0.46	0.59	700.0	54.02	52.92	51.93	43.04	43.07	43.03	60.44	64.96	70.34	36.18	36.05	35.84
800.0	0.31	0.43	0.56	0.33	0.46	0.59	800.0	52.68	51.83	50.62	41.56	41.67	41.70	57.81	61.68	65.98	34.88	34.78	34.65
900.0	0.30	0.43	0.58	0.33	0.47	0.61	900.0	51.63	50.63	49.64	40.75	40.82	40.78	56.27	59.20	62.21	33.90	33.79	33.63
1000.0	0.29	0.43	0.58	0.32	0.46	0.61	1000.0	50.66	49.80	48.65	39.64	39.71	39.77	55.64	58.38	60.55	32.90	32.80	32.67
1100.0	0.28	0.42	0.57	0.31	0.46	0.61	1100.0	50.19	49.19	48.09	38.55	38.69	38.81	54.88	57.82	60.21	31.87	31.84	31.75
1200.0	0.28	0.42	0.58	0.30	0.46	0.62	1200.0	49.19	48.18	47.21	37.93	38.03	38.14	52.86	55.59	58.15	31.06	31.05	30.99
1300.0	0.27	0.42	0.59	0.29	0.45	0.62	1300.0	48.45	47.68	46.57	37.05	37.19	37.34	51.34	53.39	55.20	30.45	30.44	30.37
1400.0	0.25	0.41	0.58	0.28	0.45	0.62	1400.0	47.90	46.87	45.90	36.60	36.73	36.86	50.54	52.54	54.07	29.72	29.74	29.72
1500.0	0.25	0.41	0.58	0.27	0.45	0.62	1500.0	46.94	46.07	45.22	35.95	36.13	36.28	49.67	51.24	52.61	29.21	29.22	29.20
1600.0	0.25	0.42	0.60	0.26	0.44	0.62	1600.0	46.83	45.93	44.80	35.17	35.38	35.55	49.41	51.03	52.06	28.56	28.59	28.57
1700.0	0.23	0.40	0.59	0.25	0.44	0.62	1700.0	45.93	44.93	44.19	35.06	35.19	35.36	48.01	49.69	51.18	28.08	28.13	28.16
1800.0	0.22	0.40	0.58	0.24	0.43	0.62	1800.0	45.97	44.96	43.96	34.40	34.58	34.73	46.67	48.08	49.02	27.86	27.86	27.79
1900.0	0.22	0.40	0.60	0.24	0.43	0.63	1900.0	45.22	44.23	43.30	34.03	34.20	34.37	46.53	47.84	48.77	27.27	27.30	27.27
2000.0	0.21	0.40	0.59	0.24	0.44	0.63	2000.0	44.03	43.18	42.37	34.00	34.11	34.17	45.35	46.49	47.21	27.02	27.01	26.96
2100.0	0.19	0.37	0.57	0.22	0.41	0.61	2100.0	44.19	43.16	42.25	33.15	33.30	33.41	45.28	46.15	46.70	26.41	26.42	26.38
2200.0	0.19	0.38	0.59	0.22	0.42	0.62	2200.0	43.15	42.15	41.22	32.82	32.98	33.06	45.00	46.28	47.32	26.04	26.06	26.02
2300.0	0.18	0.37	0.58	0.22	0.41	0.61	2300.0	42.29	41.71	40.71	32.79	32.93	32.93	43.01	43.89	44.57	26.04	25.97	25.85
2400.0	0.16	0.35	0.56	0.18	0.38	0.59	2400.0	42.28	41.31	40.53	32.07	32.14	32.26	43.72	44.19	44.63	25.19	25.19	25.14
2500.0	0.15	0.35	0.57	0.16	0.37	0.59	2500.0	41.67	40.93	40.10	31.62	31.73	31.79	43.30	44.19	44.88	24.97	24.95	24.91
2600.0	0.14	0.34	0.57	0.15	0.36	0.59	2600.0	40.74	40.14	39.50	31.47	31.57	31.62	41.89	42.56	43.00	24.51	24.55	24.49
2700.0	0.13	0.34	0.58	0.13	0.35	0.60	2700.0	40.59	39.99	39.29	30.62	30.77	30.89	42.76	43.56	43.95	23.94	23.96	23.96
2800.0	0.14	0.36	0.61	0.14	0.38	0.63	2800.0	39.88	39.34	38.69	30.59	30.72	30.78	41.71	42.79	43.51	23.91	23.92	23.91



P.O. Box 350166, Brooklyn, New York 11235-0003 (718) 934-4500 • Fax (718) 332-4661 For detailed performance specs & shopping online see Mini-Circuits web site



The Design Engineers Search Engine Provides ACTUAL Data Instantly From MINI-CIRCUITS At: www.minicircuits.com

IF/RF MICROWAVE COMPONENTS

REV. OR
JSW5-272DR+
11/11/2015
Page 6 of 9

Typical Performance Data

RF FREQ (MHz)	VSWR (:1) @ VDD=+2.5V OVER TEMPERATURE (ON STATE)												RF FREQ (MHz)	VSWR (:1) @ VDD=+2.5V OVER TEMPERATURE (OFF STATE)					
	RF COM						RF1			RF5				RF1			RF5		
	(RF1 ON)			(RF5 ON)			(RF1 ON)			(RF5 ON)				(RF2 ON)			(RF2 ON)		
	-45°C	+25°C	+90°C	-45°C	+25°C	+90°C	-45°C	+25°C	+90°C	-45°C	+25°C	+90°C		-45°C	+25°C	+90°C	-45°C	+25°C	+90°C
10.0	1.06	1.07	1.08	1.05	1.06	1.07	1.06	1.07	1.08	1.05	1.06	1.08	10.0	4.30	3.37	2.67	4.33	3.38	2.66
20.0	1.05	1.06	1.08	1.05	1.06	1.08	1.05	1.06	1.08	1.05	1.06	1.08	20.0	4.27	3.35	2.66	4.29	3.35	2.65
30.0	1.05	1.06	1.08	1.05	1.06	1.08	1.05	1.06	1.08	1.05	1.06	1.08	30.0	4.27	3.35	2.66	4.29	3.35	2.65
40.0	1.05	1.06	1.08	1.05	1.06	1.08	1.05	1.06	1.08	1.05	1.06	1.08	40.0	4.27	3.35	2.66	4.29	3.35	2.65
50.0	1.05	1.07	1.09	1.05	1.07	1.08	1.05	1.06	1.08	1.06	1.07	1.08	50.0	4.26	3.35	2.66	4.28	3.35	2.65
60.0	1.05	1.07	1.09	1.06	1.07	1.09	1.05	1.06	1.08	1.05	1.06	1.08	60.0	4.25	3.35	2.66	4.27	3.35	2.65
70.0	1.05	1.07	1.09	1.05	1.07	1.08	1.05	1.06	1.08	1.05	1.07	1.08	70.0	4.25	3.34	2.66	4.27	3.35	2.65
80.0	1.05	1.07	1.08	1.05	1.07	1.08	1.05	1.06	1.08	1.06	1.07	1.08	80.0	4.25	3.34	2.66	4.27	3.35	2.65
90.0	1.05	1.07	1.09	1.06	1.07	1.09	1.05	1.06	1.08	1.06	1.07	1.08	90.0	4.24	3.34	2.66	4.26	3.34	2.65
100.0	1.05	1.07	1.09	1.06	1.07	1.09	1.04	1.06	1.08	1.05	1.07	1.08	100.0	4.24	3.34	2.67	4.26	3.34	2.66
200.0	1.05	1.07	1.08	1.05	1.07	1.09	1.05	1.07	1.09	1.06	1.09	1.11	200.0	4.22	3.33	2.66	4.22	3.31	2.63
300.0	1.06	1.08	1.10	1.08	1.10	1.12	1.06	1.08	1.10	1.10	1.12	1.14	300.0	4.23	3.31	2.63	4.19	3.27	2.58
400.0	1.08	1.10	1.12	1.10	1.11	1.13	1.05	1.07	1.09	1.12	1.13	1.15	400.0	4.23	3.31	2.62	4.14	3.23	2.55
500.0	1.08	1.09	1.11	1.10	1.12	1.13	1.07	1.08	1.10	1.14	1.16	1.18	500.0	4.21	3.30	2.62	4.09	3.18	2.51
600.0	1.10	1.12	1.14	1.13	1.14	1.16	1.08	1.09	1.12	1.17	1.19	1.21	600.0	4.20	3.27	2.58	4.04	3.12	2.44
700.0	1.11	1.13	1.14	1.14	1.14	1.15	1.06	1.08	1.09	1.17	1.18	1.19	700.0	4.21	3.26	2.55	3.99	3.08	2.41
800.0	1.09	1.10	1.12	1.13	1.13	1.13	1.07	1.08	1.09	1.18	1.20	1.21	800.0	4.19	3.25	2.56	3.92	3.02	2.37
900.0	1.10	1.12	1.14	1.15	1.15	1.16	1.08	1.09	1.11	1.19	1.22	1.24	900.0	4.16	3.21	2.53	3.88	2.97	2.31
1000.0	1.10	1.12	1.14	1.13	1.13	1.12	1.05	1.06	1.07	1.18	1.19	1.20	1000.0	4.18	3.22	2.50	3.82	2.94	2.28
1100.0	1.08	1.09	1.10	1.12	1.11	1.08	1.06	1.06	1.07	1.19	1.21	1.21	1100.0	4.17	3.22	2.53	3.77	2.89	2.26
1200.0	1.11	1.12	1.13	1.15	1.13	1.11	1.07	1.07	1.08	1.20	1.21	1.23	1200.0	4.17	3.20	2.53	3.75	2.86	2.23
1300.0	1.12	1.13	1.15	1.09	1.08	1.07	1.04	1.03	1.03	1.15	1.16	1.16	1300.0	4.16	3.20	2.50	3.70	2.84	2.23
1400.0	1.06	1.08	1.11	1.07	1.04	1.01	1.02	1.04	1.06	1.16	1.18	1.19	1400.0	4.16	3.20	2.53	3.69	2.83	2.24
1500.0	1.09	1.10	1.11	1.08	1.06	1.04	1.02	1.03	1.04	1.16	1.18	1.20	1500.0	4.18	3.22	2.56	3.70	2.84	2.24
1600.0	1.14	1.15	1.17	1.01	1.04	1.06	1.05	1.04	1.04	1.10	1.12	1.14	1600.0	4.19	3.22	2.54	3.71	2.87	2.29
1700.0	1.10	1.12	1.14	1.07	1.08	1.09	1.07	1.08	1.10	1.15	1.18	1.19	1700.0	4.21	3.23	2.57	3.78	2.92	2.35
1800.0	1.08	1.10	1.10	1.04	1.04	1.04	1.04	1.05	1.06	1.14	1.17	1.18	1800.0	4.24	3.29	2.61	3.83	2.97	2.38
1900.0	1.17	1.17	1.18	1.11	1.12	1.13	1.10	1.09	1.08	1.15	1.16	1.16	1900.0	4.28	3.29	2.62	3.94	3.06	2.45
2000.0	1.17	1.18	1.17	1.18	1.18	1.17	1.15	1.15	1.14	1.23	1.23	1.23	2000.0	4.33	3.34	2.67	4.06	3.16	2.52
2100.0	1.09	1.10	1.09	1.12	1.12	1.09	1.10	1.10	1.09	1.20	1.20	1.19	2100.0	4.39	3.42	2.69	4.19	3.24	2.57
2200.0	1.16	1.16	1.15	1.17	1.16	1.15	1.12	1.10	1.09	1.20	1.18	1.15	2200.0	4.43	3.40	2.70	4.32	3.33	2.65
2300.0	1.17	1.16	1.14	1.22	1.20	1.17	1.17	1.15	1.13	1.25	1.23	1.20	2300.0	4.48	3.47	2.75	4.47	3.45	2.74
2400.0	1.07	1.05	1.03	1.12	1.09	1.05	1.12	1.12	1.11	1.18	1.16	1.14	2400.0	4.54	3.49	2.75	4.69	3.56	2.78
2500.0	1.07	1.06	1.07	1.10	1.08	1.08	1.08	1.07	1.06	1.11	1.09	1.07	2500.0	4.53	3.47	2.74	4.80	3.62	2.81
2600.0	1.09	1.07	1.05	1.10	1.08	1.06	1.13	1.12	1.10	1.14	1.12	1.11	2600.0	4.60	3.52	2.77	4.86	3.70	2.85
2700.0	1.09	1.08	1.08	1.05	1.06	1.08	1.13	1.15	1.16	1.09	1.11	1.14	2700.0	4.68	3.54	2.76	5.04	3.73	2.84
2800.0	1.09	1.11	1.13	1.13	1.15	1.17	1.10	1.11	1.13	1.09	1.11	1.13	2800.0	4.63	3.54	2.72	5.04	3.71	2.83



P.O. Box 350166, Brooklyn, New York 11235-0003 (718) 934-4500 • Fax (718) 332-4661 For detailed performance specs & shopping online see Mini-Circuits web site www.minicircuits.com



The Design Engineers Search Engine Provides ACTUAL Data Instantly From MINI-CIRCUITS At: www.minicircuits.com

IF/RF MICROWAVE COMPONENTS

REV. OR

JSW5-272DR+

11/11/2015

Page 7 of 9

Typical Performance Data

RF FREQ (MHz)	INSERTION LOSS (dB) @ VDD=+4.8V OVER TEMPERATURE						RF FREQ (MHz)	ISOLATION (dB) @ VDD=+4.8V OVER TEMPERATURE											
	RF COM-RF1			RF COM-RF6				RF COM-RF1 (RF2 ON)			RF COM-RF5 (RF4 ON)			RF3-RF4 (RF3 ON)			RF3-RF5 (RF3 ON)		
	-45°C	+25°C	+90°C	-45°C	+25°C	+90°C		-45°C	+25°C	+90°C	-45°C	+25°C	+90°C	-45°C	+25°C	+90°C	-45°C	+25°C	+90°C
10.0	0.33	0.41	0.49	0.31	0.39	0.47	10.0	59.38	62.30	56.45	60.44	59.10	63.77	65.22	62.79	55.60	59.24	55.22	66.30
20.0	0.34	0.42	0.50	0.34	0.42	0.50	20.0	76.70	74.87	79.21	76.11	73.26	73.31	79.14	77.79	77.94	66.72	65.63	67.80
30.0	0.34	0.42	0.50	0.34	0.42	0.50	30.0	83.82	82.69	85.31	71.39	72.15	70.79	77.29	79.48	83.52	64.18	64.63	63.06
40.0	0.35	0.42	0.50	0.34	0.42	0.50	40.0	81.43	82.00	76.66	68.16	68.76	67.87	83.53	85.59	84.58	61.76	61.55	60.43
50.0	0.35	0.42	0.50	0.34	0.41	0.49	50.0	59.90	62.71	62.82	58.65	58.10	65.24	61.79	62.11	61.45	61.08	68.78	55.83
60.0	0.35	0.42	0.50	0.34	0.41	0.49	60.0	67.21	68.23	69.41	64.00	60.74	74.21	67.17	68.21	68.84	60.50	59.58	57.88
70.0	0.35	0.42	0.50	0.35	0.42	0.50	70.0	74.25	73.78	72.46	64.05	63.19	63.78	78.23	86.02	88.72	56.88	56.68	56.03
80.0	0.35	0.42	0.50	0.35	0.42	0.50	80.0	73.67	72.65	72.26	62.12	62.40	61.97	79.60	84.57	99.04	55.42	55.20	54.83
90.0	0.36	0.43	0.50	0.35	0.42	0.50	90.0	73.08	71.48	69.75	61.57	61.62	60.92	77.25	82.01	84.58	54.42	54.12	53.90
100.0	0.36	0.43	0.51	0.35	0.42	0.50	100.0	72.77	70.08	68.22	60.77	60.71	59.99	75.64	79.59	86.78	53.65	53.22	53.17
200.0	0.35	0.43	0.51	0.35	0.43	0.51	200.0	65.29	64.22	63.06	54.20	54.23	54.17	70.31	75.06	88.88	47.37	47.14	46.98
300.0	0.35	0.43	0.53	0.35	0.44	0.53	300.0	61.70	60.07	59.25	50.52	50.47	50.52	66.34	71.74	76.82	43.92	43.66	43.41
400.0	0.34	0.44	0.54	0.35	0.44	0.55	400.0	58.84	57.92	56.70	48.32	48.26	48.07	65.85	70.67	74.93	41.32	41.12	40.84
500.0	0.33	0.43	0.54	0.34	0.45	0.56	500.0	56.78	55.78	54.71	46.15	46.18	46.06	62.82	67.48	72.83	39.28	39.09	38.88
600.0	0.33	0.44	0.56	0.34	0.46	0.58	600.0	55.33	54.20	53.11	44.38	44.41	44.38	61.93	66.32	69.47	37.66	37.49	37.23
700.0	0.32	0.44	0.57	0.34	0.46	0.59	700.0	53.98	53.01	51.93	43.00	43.06	43.02	60.36	64.98	69.94	36.17	36.03	35.85
800.0	0.31	0.43	0.56	0.33	0.46	0.59	800.0	52.66	51.65	50.68	41.57	41.62	41.70	58.00	62.04	66.00	34.89	34.79	34.64
900.0	0.30	0.44	0.57	0.33	0.47	0.61	900.0	51.68	50.72	49.67	40.74	40.81	40.78	56.16	59.11	62.16	33.90	33.79	33.62
1000.0	0.29	0.43	0.58	0.32	0.46	0.61	1000.0	50.63	49.67	48.73	39.64	39.71	39.77	55.63	58.49	60.36	32.91	32.81	32.65
1100.0	0.28	0.42	0.57	0.31	0.46	0.61	1100.0	50.21	49.09	48.16	38.55	38.73	38.82	55.02	58.05	60.06	31.86	31.84	31.75
1200.0	0.28	0.43	0.58	0.30	0.46	0.62	1200.0	49.23	48.21	47.22	37.94	38.05	38.13	52.83	55.69	58.15	31.06	31.05	30.99
1300.0	0.27	0.43	0.59	0.29	0.45	0.62	1300.0	48.48	47.58	46.50	37.06	37.19	37.35	51.34	53.42	55.27	30.44	30.43	30.37
1400.0	0.25	0.41	0.58	0.28	0.45	0.62	1400.0	47.91	46.91	45.90	36.60	36.75	36.85	50.64	52.68	54.05	29.71	29.74	29.71
1500.0	0.25	0.41	0.58	0.27	0.45	0.62	1500.0	46.91	46.09	45.21	35.94	36.13	36.28	49.57	51.40	52.60	29.20	29.22	29.19
1600.0	0.25	0.42	0.60	0.26	0.44	0.62	1600.0	46.83	45.89	44.80	35.17	35.37	35.55	49.40	51.08	52.08	28.56	28.60	28.56
1700.0	0.23	0.41	0.59	0.25	0.44	0.62	1700.0	45.95	45.11	44.21	35.04	35.21	35.36	47.98	49.71	51.06	28.09	28.14	28.16
1800.0	0.22	0.40	0.58	0.24	0.43	0.62	1800.0	45.98	44.99	43.98	34.40	34.60	34.72	46.66	47.99	49.09	27.85	27.86	27.79
1900.0	0.23	0.41	0.60	0.24	0.44	0.63	1900.0	45.27	44.17	43.29	34.04	34.20	34.34	46.51	47.74	48.82	27.28	27.30	27.27
2000.0	0.21	0.40	0.59	0.24	0.44	0.63	2000.0	43.97	43.30	42.39	34.00	34.11	34.19	45.32	46.39	47.22	27.02	27.02	26.96
2100.0	0.19	0.38	0.57	0.22	0.42	0.61	2100.0	44.18	43.17	42.28	33.15	33.30	33.42	45.29	46.16	46.72	26.41	26.43	26.38
2200.0	0.19	0.38	0.58	0.22	0.42	0.62	2200.0	43.17	42.27	41.26	32.81	32.96	33.06	44.99	46.32	47.33	26.05	26.08	26.02
2300.0	0.18	0.38	0.58	0.22	0.41	0.61	2300.0	42.30	41.52	40.72	32.84	32.91	32.94	43.09	43.91	44.63	26.03	25.99	25.85
2400.0	0.16	0.35	0.56	0.18	0.38	0.59	2400.0	42.33	41.46	40.57	32.07	32.20	32.27	43.62	44.33	44.67	25.20	25.20	25.14
2500.0	0.15	0.36	0.57	0.16	0.37	0.59	2500.0	41.62	40.82	40.11	31.62	31.73	31.78	43.31	44.28	44.84	24.97	24.95	24.90
2600.0	0.14	0.35	0.57	0.15	0.36	0.59	2600.0	40.77	40.16	39.55	31.47	31.57	31.61	41.94	42.64	43.04	24.50	24.53	24.48
2700.0	0.13	0.35	0.58	0.13	0.36	0.59	2700.0	40.55	39.85	39.33	30.62	30.76	30.89	42.73	43.46	43.92	23.93	23.97	23.95
2800.0	0.14	0.36	0.61	0.15	0.38	0.63	2800.0	39.85	39.22	38.67	30.60	30.73	30.78	41.73	42.72	43.52	23.91	23.93	23.91



P.O. Box 350166, Brooklyn, New York 11235-0003 (718) 934-4500 • Fax (718) 332-4661 For detailed performance specs & shopping online see Mini-Circuits web site



The Design Engineers Search Engine Provides ACTUAL Data Instantly From MINI-CIRCUITS At: www.minicircuits.com

IF/RF MICROWAVE COMPONENTS

REV. OR
JSW5-272DR+
11/11/2015
Page 8 of 9

Typical Performance Data

RF FREQ (MHz)	VSWR (:1) @ VDD=+4.8 OVER TEMPERATURE (ON STATE)												RF FREQ (MHz)	VSWR (:1) @ VDD=+4.8V OVER TEMPERATURE (OFF STATE)					
	RF COM						RF1			RF5				RF1			RF5		
	(RF1 ON)			(RF5 ON)			(RF1 ON)			(RF5 ON)				(RF2 ON)			(RF2 ON)		
	-45°C	+25°C	+90°C	-45°C	+25°C	+90°C	-45°C	+25°C	+90°C	-45°C	+25°C	+90°C		-45°C	+25°C	+90°C	-45°C	+25°C	+90°C
10.0	1.06	1.07	1.08	1.05	1.06	1.08	1.06	1.07	1.08	1.05	1.06	1.08	10.0	4.31	3.36	2.67	4.34	3.36	2.66
20.0	1.05	1.06	1.08	1.05	1.06	1.08	1.05	1.06	1.08	1.05	1.06	1.08	20.0	4.27	3.34	2.66	4.30	3.34	2.65
30.0	1.05	1.06	1.08	1.05	1.06	1.08	1.05	1.06	1.08	1.05	1.07	1.08	30.0	4.27	3.34	2.66	4.30	3.34	2.65
40.0	1.05	1.06	1.08	1.05	1.06	1.08	1.05	1.06	1.08	1.05	1.07	1.08	40.0	4.27	3.34	2.66	4.29	3.34	2.65
50.0	1.05	1.07	1.08	1.05	1.07	1.09	1.05	1.06	1.08	1.06	1.07	1.08	50.0	4.26	3.34	2.66	4.29	3.34	2.65
60.0	1.05	1.07	1.09	1.06	1.07	1.09	1.05	1.06	1.08	1.05	1.06	1.08	60.0	4.26	3.34	2.66	4.28	3.34	2.65
70.0	1.05	1.07	1.09	1.05	1.07	1.08	1.05	1.06	1.08	1.05	1.07	1.08	70.0	4.25	3.33	2.66	4.28	3.34	2.65
80.0	1.05	1.07	1.08	1.05	1.07	1.08	1.05	1.06	1.08	1.06	1.07	1.08	80.0	4.25	3.33	2.66	4.27	3.33	2.65
90.0	1.05	1.07	1.09	1.06	1.07	1.09	1.05	1.06	1.08	1.06	1.07	1.08	90.0	4.25	3.33	2.66	4.27	3.33	2.66
100.0	1.05	1.07	1.09	1.06	1.07	1.09	1.04	1.06	1.08	1.05	1.07	1.08	100.0	4.24	3.33	2.67	4.26	3.33	2.66
200.0	1.05	1.07	1.08	1.05	1.07	1.09	1.05	1.07	1.09	1.06	1.09	1.11	200.0	4.22	3.31	2.66	4.23	3.30	2.63
300.0	1.06	1.08	1.10	1.08	1.10	1.12	1.06	1.08	1.10	1.10	1.12	1.14	300.0	4.23	3.30	2.63	4.20	3.26	2.58
400.0	1.08	1.10	1.12	1.10	1.11	1.13	1.05	1.07	1.09	1.12	1.13	1.15	400.0	4.24	3.30	2.62	4.14	3.21	2.55
500.0	1.08	1.10	1.11	1.10	1.12	1.13	1.07	1.08	1.10	1.14	1.16	1.18	500.0	4.22	3.29	2.62	4.09	3.16	2.51
600.0	1.10	1.12	1.14	1.13	1.15	1.16	1.08	1.10	1.12	1.17	1.19	1.21	600.0	4.20	3.26	2.58	4.05	3.11	2.45
700.0	1.11	1.13	1.14	1.14	1.14	1.15	1.06	1.08	1.09	1.17	1.18	1.19	700.0	4.21	3.25	2.55	3.99	3.06	2.41
800.0	1.09	1.11	1.12	1.13	1.13	1.13	1.07	1.09	1.09	1.18	1.20	1.21	800.0	4.19	3.23	2.56	3.93	3.01	2.37
900.0	1.10	1.13	1.14	1.15	1.16	1.16	1.08	1.09	1.11	1.20	1.21	1.24	900.0	4.16	3.21	2.53	3.89	2.96	2.31
1000.0	1.10	1.12	1.14	1.13	1.13	1.12	1.05	1.06	1.07	1.18	1.19	1.20	1000.0	4.19	3.20	2.51	3.83	2.91	2.29
1100.0	1.08	1.09	1.10	1.12	1.10	1.08	1.06	1.06	1.07	1.19	1.21	1.21	1100.0	4.18	3.20	2.53	3.78	2.88	2.26
1200.0	1.11	1.12	1.13	1.15	1.13	1.11	1.07	1.07	1.08	1.20	1.21	1.23	1200.0	4.17	3.20	2.53	3.76	2.85	2.23
1300.0	1.12	1.13	1.15	1.09	1.08	1.07	1.04	1.03	1.03	1.15	1.16	1.16	1300.0	4.17	3.18	2.51	3.70	2.81	2.23
1400.0	1.06	1.08	1.11	1.07	1.04	1.01	1.02	1.04	1.06	1.16	1.18	1.19	1400.0	4.16	3.19	2.53	3.69	2.82	2.25
1500.0	1.09	1.10	1.11	1.09	1.06	1.04	1.03	1.03	1.04	1.16	1.17	1.20	1500.0	4.18	3.21	2.56	3.70	2.84	2.24
1600.0	1.14	1.15	1.17	1.02	1.04	1.06	1.05	1.03	1.04	1.10	1.13	1.14	1600.0	4.20	3.20	2.54	3.73	2.85	2.30
1700.0	1.10	1.13	1.14	1.08	1.08	1.09	1.07	1.09	1.10	1.15	1.17	1.19	1700.0	4.21	3.23	2.57	3.79	2.91	2.35
1800.0	1.08	1.10	1.10	1.04	1.04	1.04	1.04	1.05	1.06	1.14	1.16	1.18	1800.0	4.24	3.27	2.61	3.85	2.98	2.37
1900.0	1.17	1.17	1.18	1.12	1.12	1.13	1.10	1.09	1.08	1.15	1.17	1.16	1900.0	4.28	3.29	2.62	3.95	3.03	2.45
2000.0	1.17	1.18	1.17	1.19	1.18	1.17	1.15	1.15	1.14	1.23	1.23	1.22	2000.0	4.34	3.33	2.66	4.07	3.14	2.52
2100.0	1.09	1.09	1.09	1.12	1.11	1.09	1.10	1.10	1.09	1.20	1.20	1.19	2100.0	4.40	3.39	2.70	4.19	3.25	2.57
2200.0	1.16	1.16	1.15	1.17	1.16	1.15	1.12	1.11	1.08	1.20	1.19	1.15	2200.0	4.42	3.41	2.69	4.32	3.30	2.66
2300.0	1.17	1.16	1.14	1.23	1.20	1.17	1.17	1.16	1.14	1.25	1.22	1.20	2300.0	4.50	3.43	2.75	4.48	3.43	2.74
2400.0	1.07	1.05	1.03	1.11	1.09	1.05	1.12	1.11	1.11	1.18	1.16	1.14	2400.0	4.54	3.48	2.75	4.70	3.57	2.78
2500.0	1.07	1.06	1.07	1.10	1.08	1.08	1.08	1.07	1.06	1.11	1.10	1.07	2500.0	4.53	3.45	2.74	4.82	3.58	2.81
2600.0	1.09	1.07	1.05	1.11	1.08	1.06	1.13	1.12	1.10	1.14	1.11	1.11	2600.0	4.61	3.49	2.77	4.88	3.67	2.85
2700.0	1.09	1.08	1.08	1.05	1.06	1.08	1.13	1.14	1.15	1.09	1.11	1.14	2700.0	4.67	3.54	2.76	5.04	3.74	2.84
2800.0	1.09	1.11	1.13	1.13	1.15	1.17	1.09	1.12	1.13	1.09	1.11	1.14	2800.0	4.63	3.50	2.72	5.06	3.67	2.84



P.O. Box 350166, Brooklyn, New York 11235-0003 (718) 934-4500 • Fax (718) 332-4661 For detailed performance specs & shopping online see Mini-Circuits web site JSW5-272DR+

The Design Engineers Search Engine Provides ACTUAL Data Instantly From MINI-CIRCUITS At: www.minicircuits.com

IF/RF MICROWAVE COMPONENTS

Typical Performance Curves

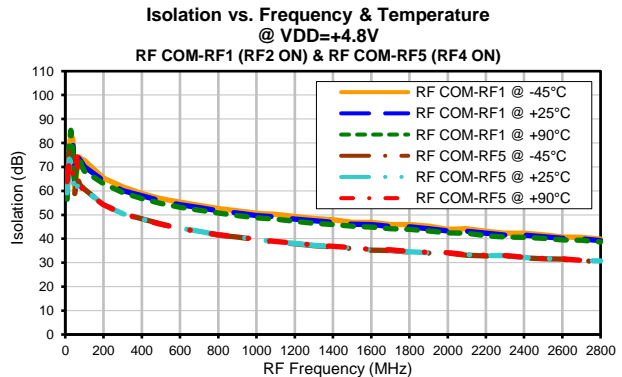
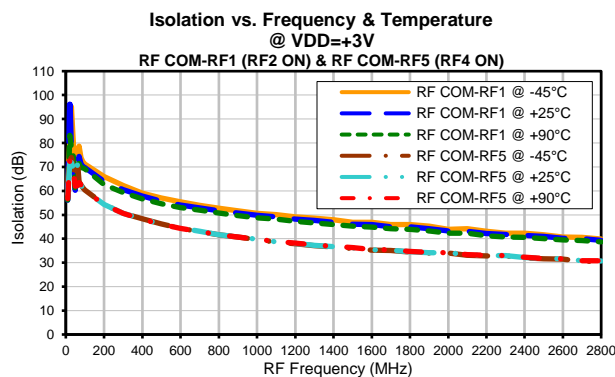
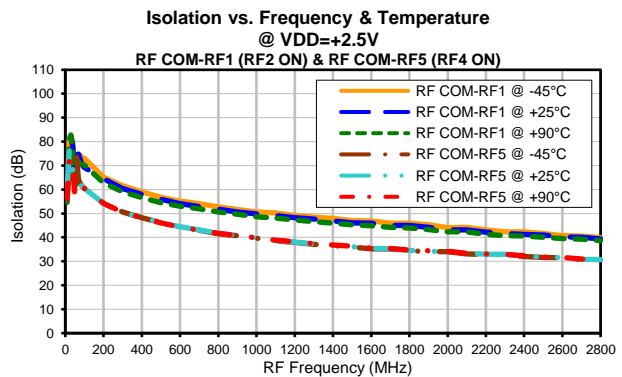
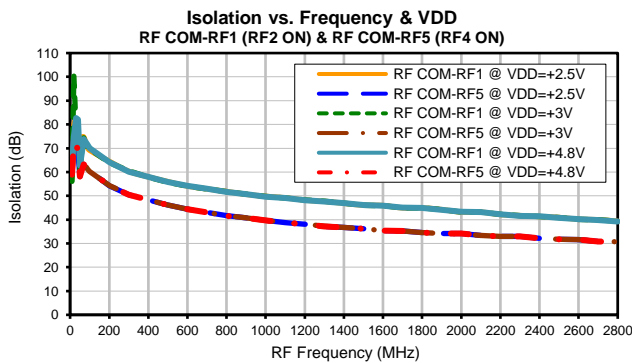
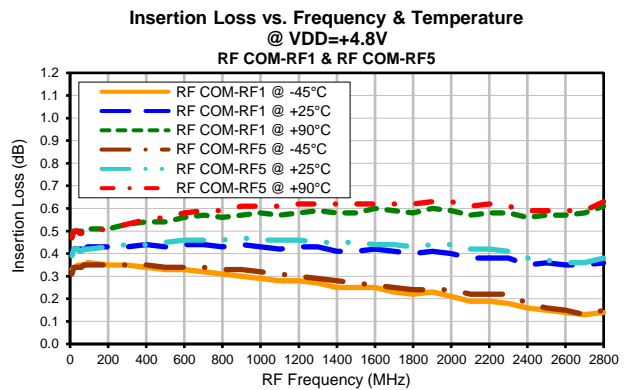
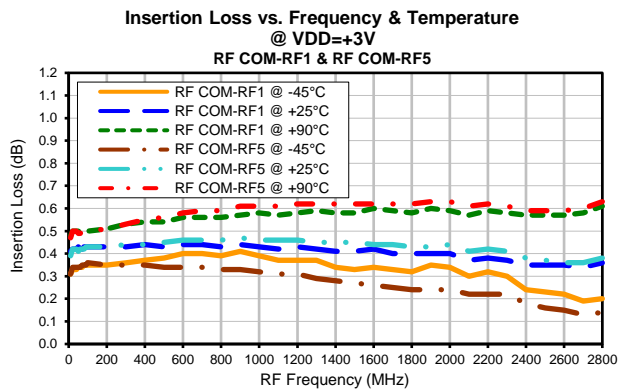
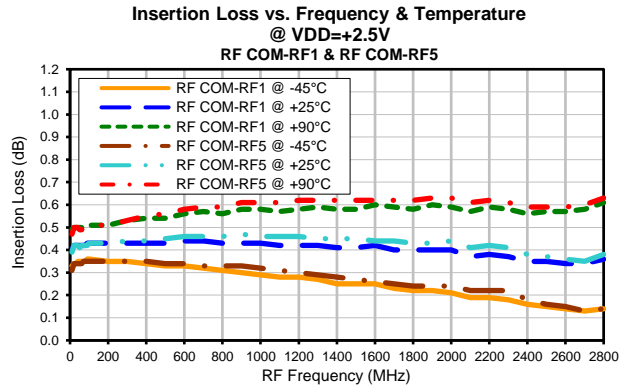
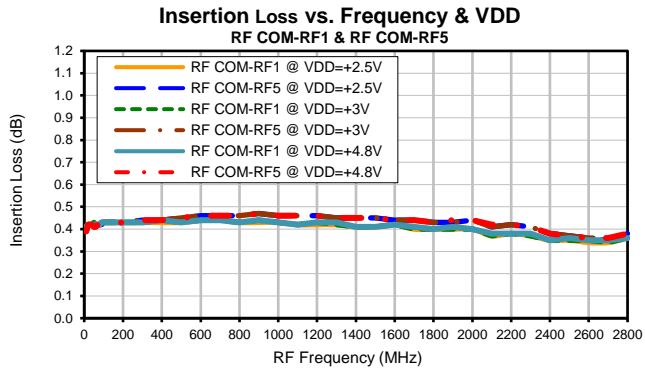

Typical Performance Curves

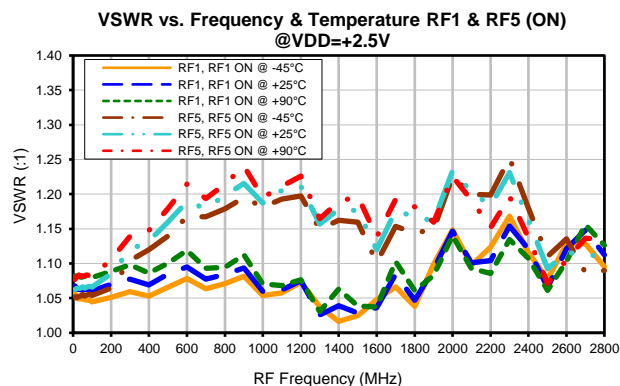
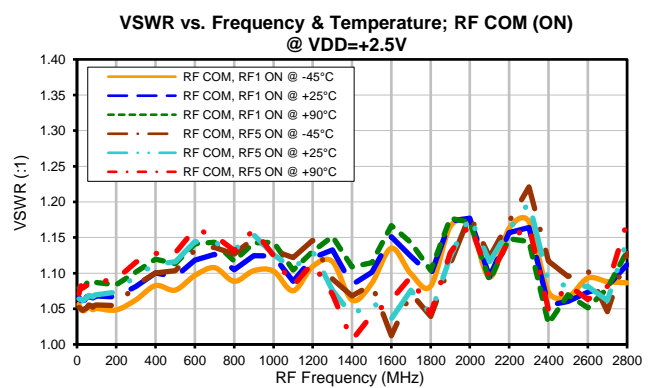
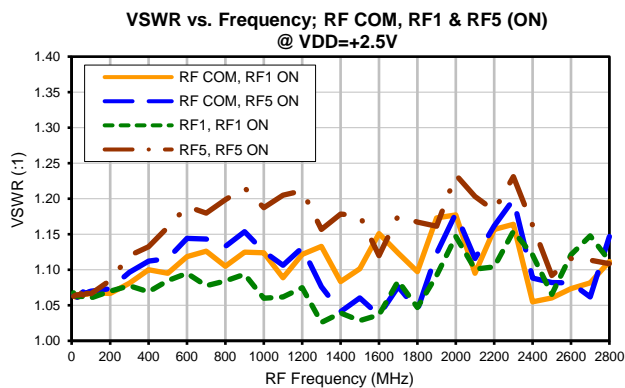
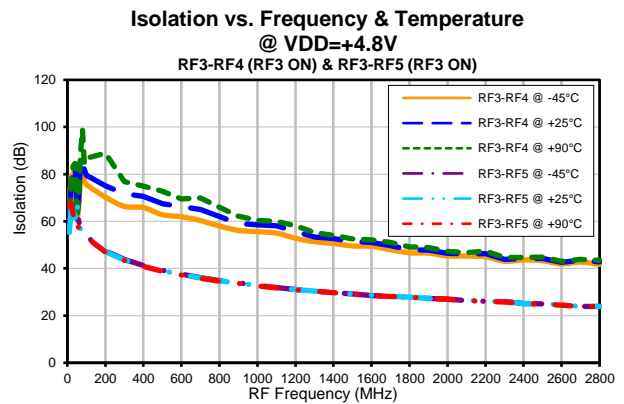
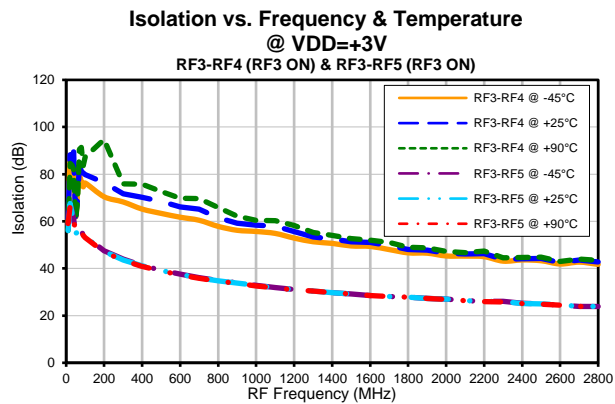
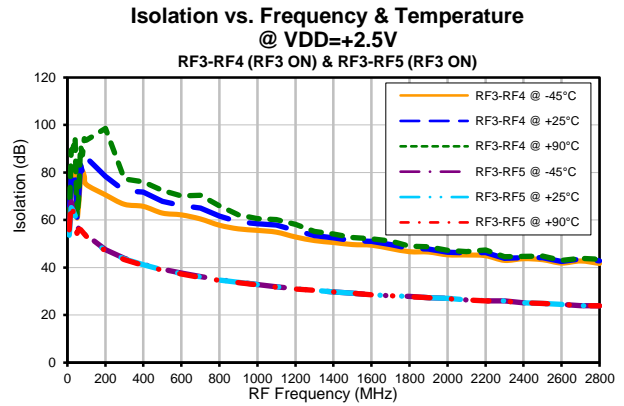
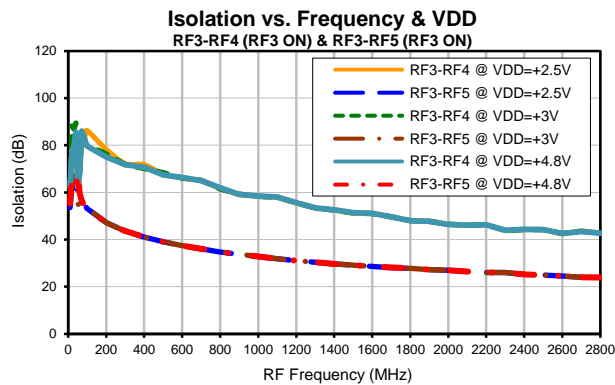

Typical Performance Curves

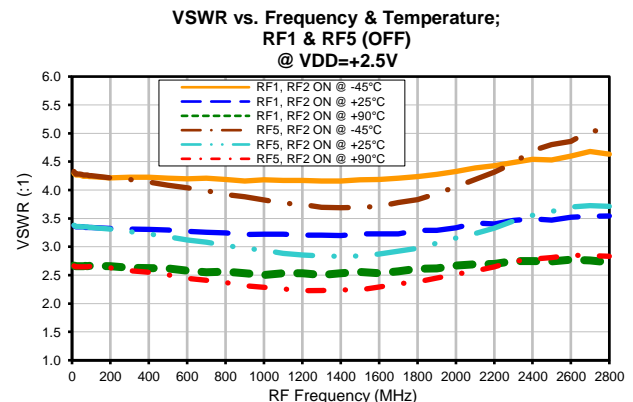
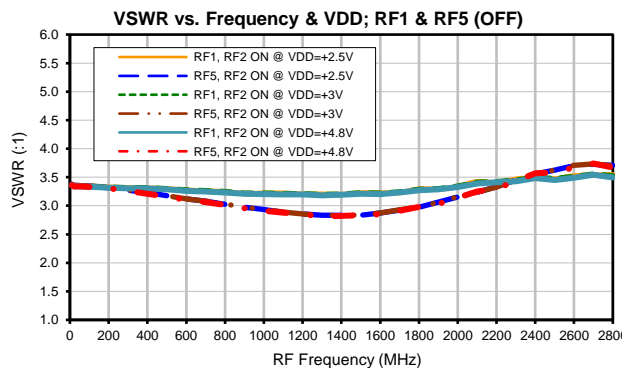
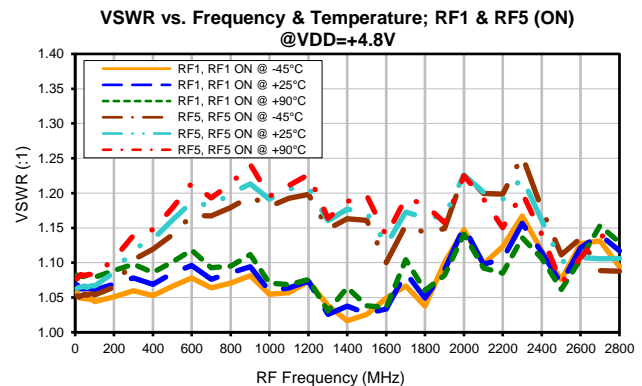
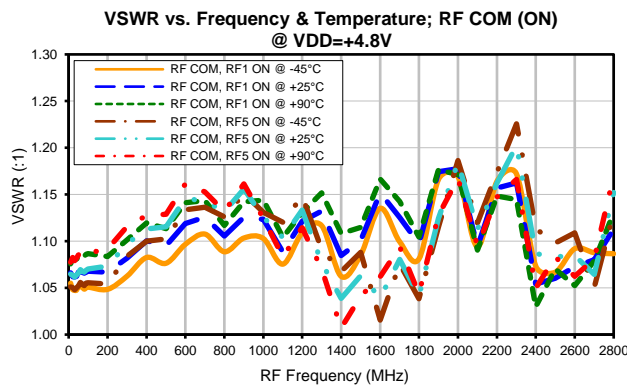
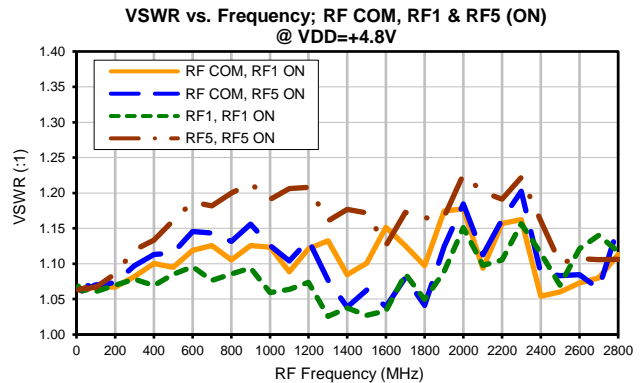
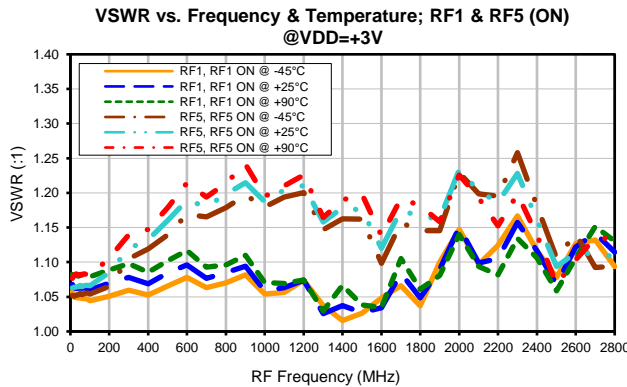
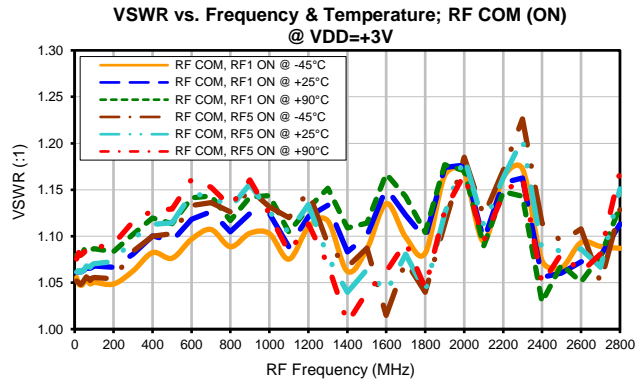
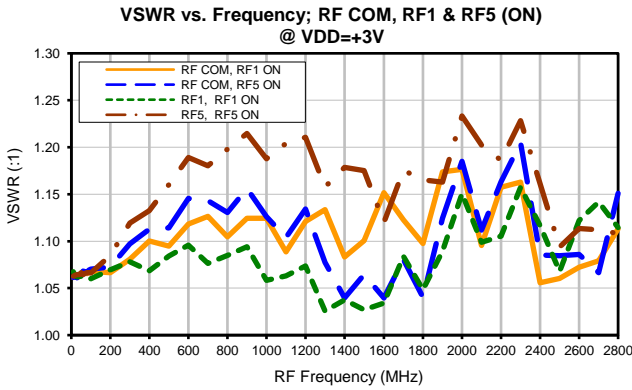

Typical Performance Curves

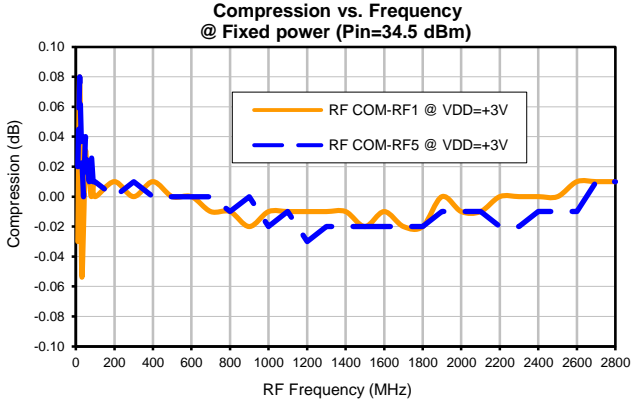
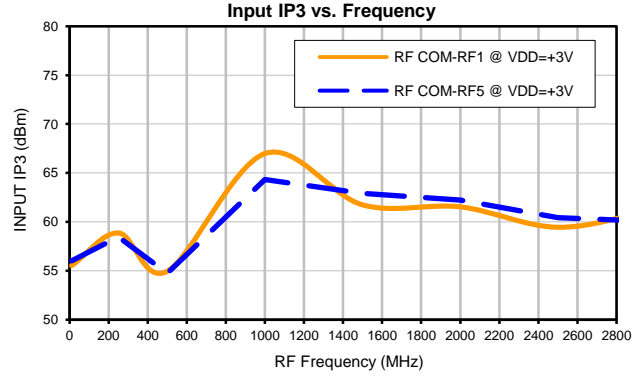
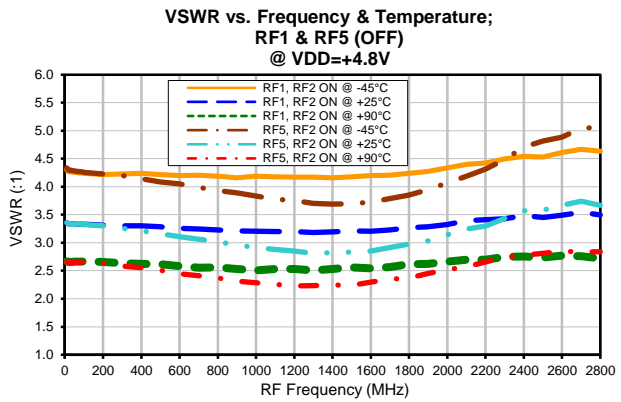
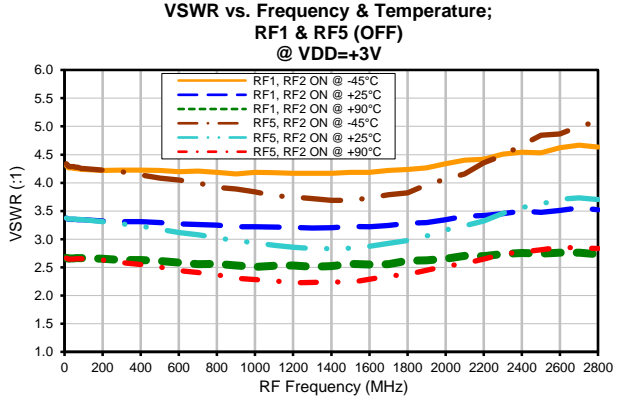

Outline Dimensions

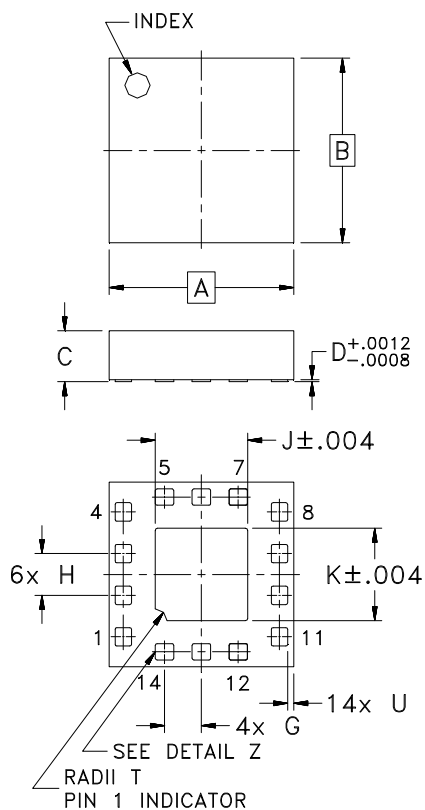

PCB Land Pattern

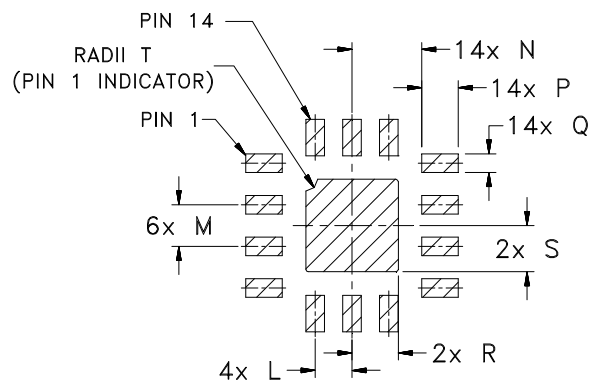

Suggested Layout,
Tolerance to be within $\pm .002$

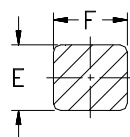

DETAIL Z
SCALE 4:1
3X THIS ROTATION
3X ROTATED 180°
4X ROTATED 90°CW
4X ROTATED 90°CCW

CASE#	A	B	C	D	E	F	G	H	J	K	L	M	N
MT1817	.079 (2.00)	.079 (2.00)	.022 (0.55)	.0008 (0.02)	.007 (0.18)	.008 (0.20)	.016 (0.40)	.018 (0.45)	.039 (1.00)	.039 (1.00)	.016 (0.40)	.018 (0.45)	.030 (0.75)

CASE#	P	Q	R	S	T	U	WT, GRAM
MT1817	.016 (0.40)	.008 (0.20)	.020 (0.50)	.020 (0.50)	.005 (0.13)	.003 (0.065)	.008

Dimensions are in inches (mm). Tolerances: 3 Pl. $\pm .002$

Notes:

1. Case material: Plastic.
2. Termination finish: Matte Tin.



Distribution Centers NORTH AMERICA 800-654-7949 • 417-335-5935 • Fax 417-335-5945 • EUROPE 44-1252-832600 • Fax 44-1252-837010

Mini-Circuits ISO 9001 & ISO 14001 Certified

INTERNET <http://www.minicircuits.com>

P.O. Box 350166, Brooklyn, New York 11235-0003 (718) 934-4500 Fax (718) 332-4661

Tape & Reel Packaging TR-F108

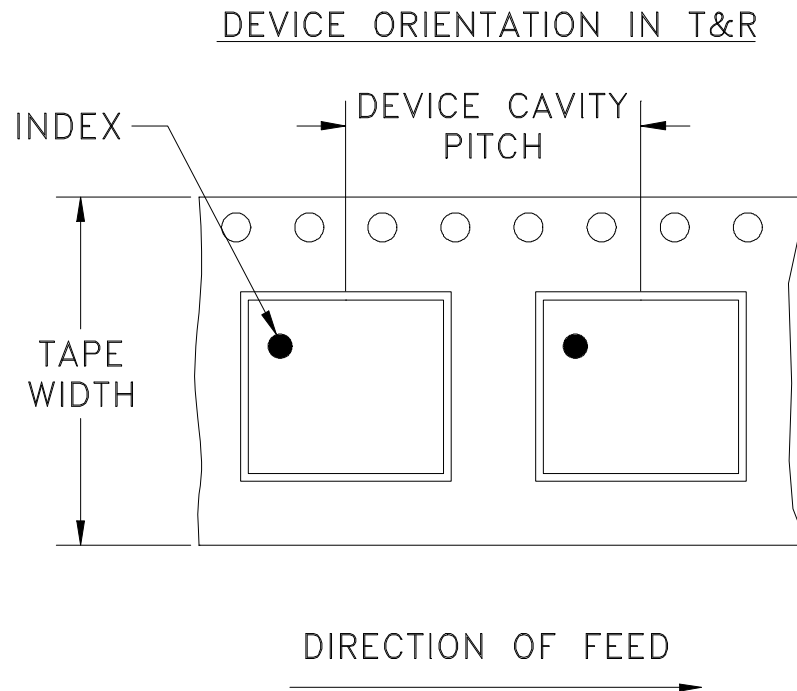

Tape Width, mm	Device Cavity Pitch, mm	Reel Size, inches	Devices per Reel	
12	4	7	Small quantity standards	20
				50
				100
				200
				500
				1000
		7	Standard	2000
				3000

Note: Please Consult individual data sheet to determine device per reel availability

Mini-Circuits carrier tape materials provide protection from ESD (Electro-Static Discharge) during handling and transportation. Tapes are static dissipative and comply with industry standards EIA-481/EIA-541.

Go to: www.minicircuits.com/pages/pdfs/tape.pdf

Mini-Circuits®

INTERNET <http://www.minicircuits.com>

P.O. Box 350166, Brooklyn, New York 11235-0003 (718) 934-4500 Fax (718) 332-4661

Distribution Centers NORTH AMERICA 800-654-7949 • 417-335-5935 • Fax 417-335-5945 • EUROPE 44-1252-832600 • Fax 44-1252-837010

Mini-Circuits ISO 9001 & ISO 14001 Certified

THIRD ANGLE PROJECTION

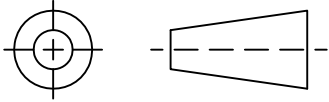

REVISIONS

REV	ECN No.	DESCRIPTION	DATE	DR	AUTH
OR	M152910	NEW RELEASE	11/09/15	ITG	ZL

SUGGESTED MOUNTING CONFIGURATION
FOR MT1817 CASE STYLE, "14SW05" PIN CODE

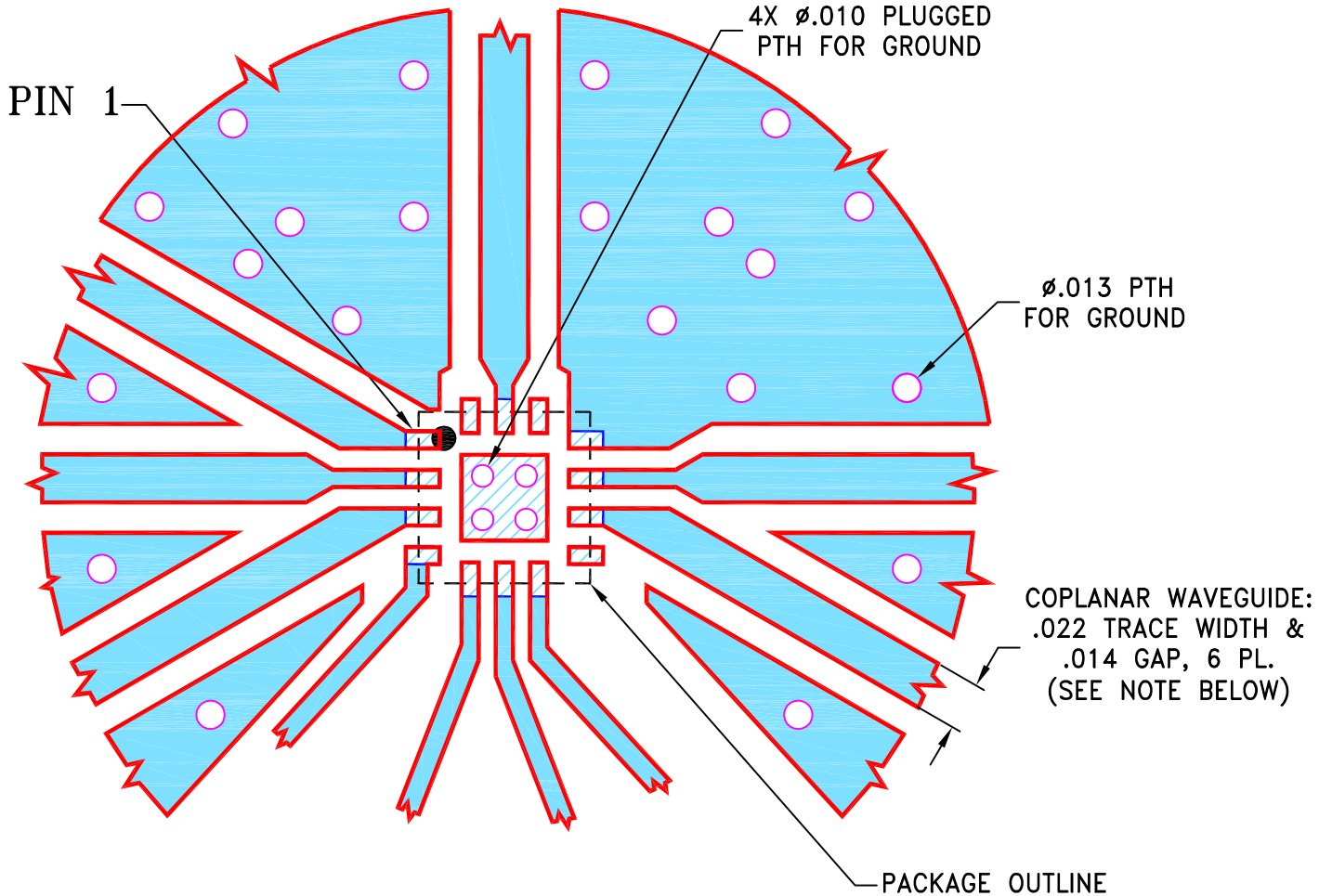

NOTES:

1. TRACE WIDTH IS SHOWN FOR ROGERS R04350B WITH DIELECTRIC THICKNESS .010"±.001"; COPPER: 1/2 OZ. EACH SIDE. FOR OTHER MATERIALS TRACE WIDTH AND GAP MAY NEED TO BE MODIFIED.
2. BOTTOM SIDE OF THE PCB IS CONTINUOUS GROUND PLANE.



DENOTES PCB COPPER LAYOUT WITH SMOBC (SOLDER MASK OVER BARE COPPER).



DENOTES COPPER LAND PATTERN FREE OF SOLDER MASK.

UNLESS OTHERWISE SPECIFIED	INITIALS		DATE
DIMENSIONS ARE IN INCHES TOLERANCES ON: 2 PL DECIMALS ± 3 PL DECIMALS ± .005 ANGLES ± FRACTIONS ±	DRAWN	ITG	11/09/15
	CHECKED	GF	11/09/15
	APPROVED	ZL	11/09/15



Mini-Circuits®

13 Neptune Avenue
Brooklyn NY 11235

PL, 14SW05, MT1817, TB-724-5+

Mini-Circuits®
THIS DOCUMENT AND ITS CONTENTS ARE THE PROPERTY OF MINI-CIRCUITS. EXCEPT FOR USE EXPRESSLY GRANTED, IN WRITING, TO ITS VENDORS, VENDEE AND THE UNITED STATES GOVERNMENT, MINI-CIRCUITS RESERVES ALL PROPRIETARY DESIGN, USE, MANUFACTURING AND REPRODUCTION RIGHTS THERETO. THESE CONTENTS SHALL NOT BE USED, DUPLICATED OR DISCLOSED TO ANY OUTSIDE PARTY, IN WHOLE OR IN PART, WITHOUT WRITTEN PERMISSION OF MINI-CIRCUITS.

SIZE	CODE IDENT	DRAWING NO:	REV:
A	15542	98-PL-463	OR
FILE:	98PL463	SCALE:	12:1
		SHEET:	1 OF 1

Evaluation Board and Circuit

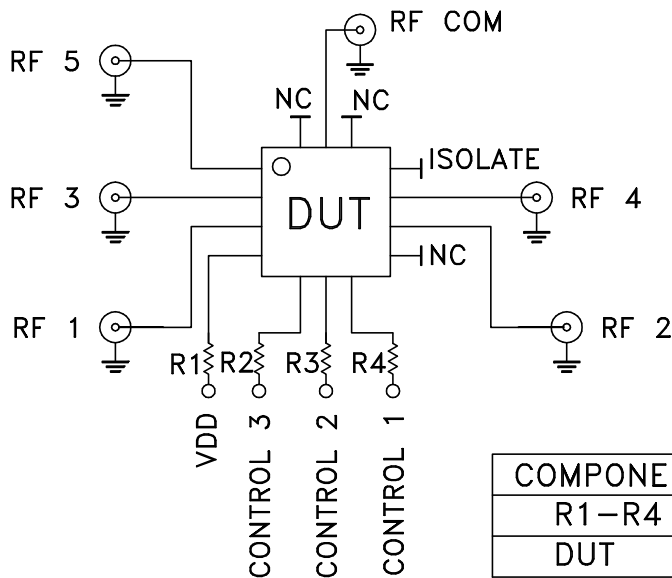
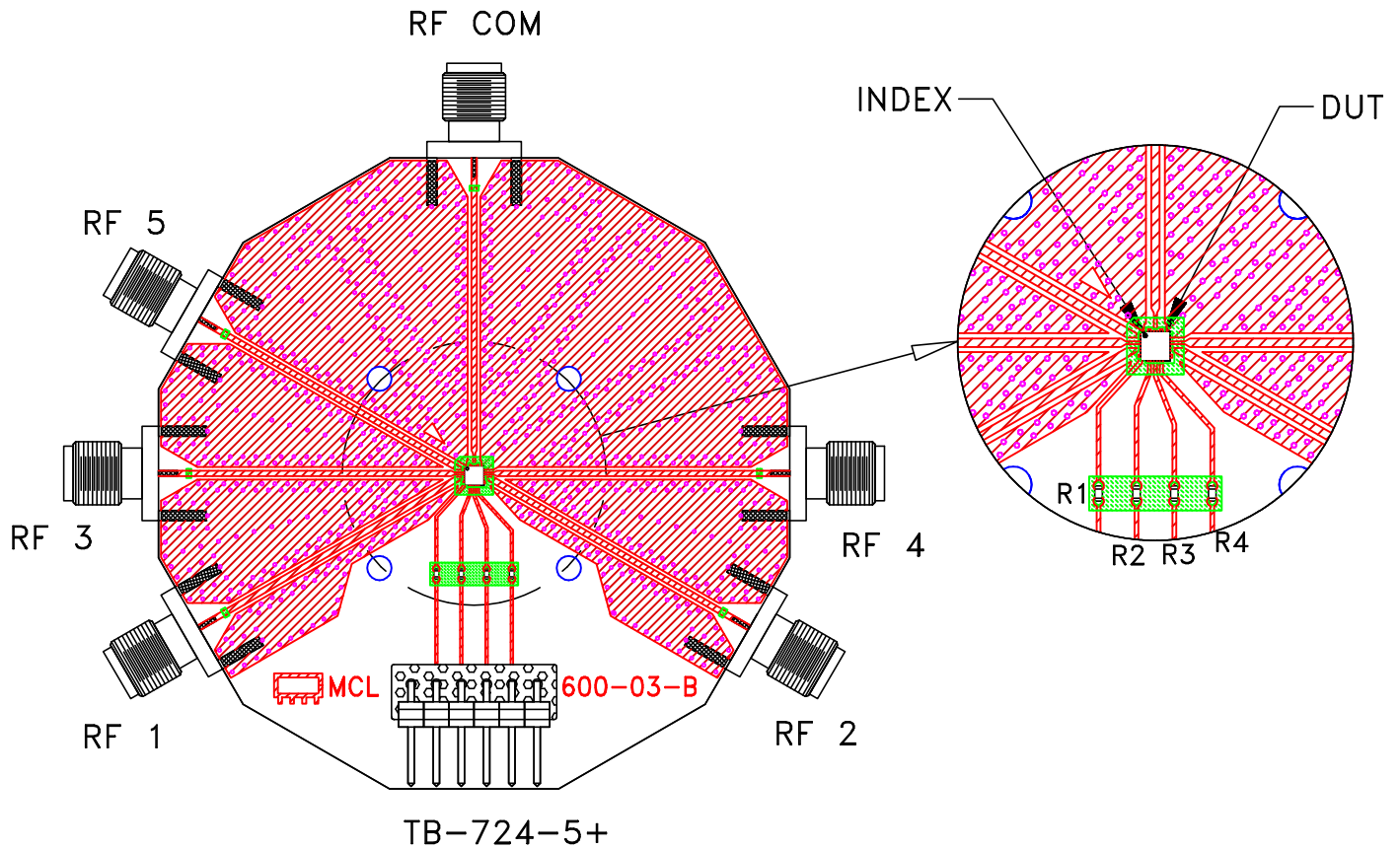

COMPONENT	VALUE/PART NUMBER	SIZE
R1-R4	1 kOhm	0402
DUT	JSW5-272DR+	0402

Schematic Diagram

Notes:

1. 50 Ohm SMA Female connectors.
2. PCB Material: RO4350 or equivalent,
Dielectric Constant=3.5,
Thickness=.010 inch.

 **Mini-Circuits®**

All Mini-Circuits products are manufactured under exacting quality assurance and control standards, and are capable of meeting published specifications after being subjected to any or all of the following physical and environmental test.

Specification	Test/Inspection Condition	Reference/Spec
Operating Temperature	-40° to 85° C Ambient Environment	Individual Model Data Sheet
Storage Temperature	-65° to 150° C / -40° to 125° C / -55° to 150° C Ambient Environment	Individual Model Data Sheet
Temperature Cycling	-65° to 150°C, 500 cycles	JESD22-A104, condition C
HAST	130°C, 85% RH, 33 PSIA, 96 hours, nominal bias	JESD22-A110
High Temp Storage	150°C 1000 hours	JESD22-A103
Solderability	Per Reference Spec	JESD22-B102
Moisture Sensitivity: Level 1	Bake at 125°C for 24 hours Soak at 85°C/85% RH for 168 hours, Reflow 3 cycles at 260°C peak	J-STD-020 D.01