

Surface Mount

# Monolithic Amplifier

DC-4 GHz

## Features

- InGaP HBT microwave amplifier
- Miniature SOT-89 package
- Internally Matched to 50 Ohms
- Frequency range, DC to 4 GHz
- Output power, 13.4 dBm typ.
- Excellent package for heat dissipation, exposed metal bottom
- Low thermal resistance for high reliability
- Aqueous washable
- Protected by US Patent 6,943,629

## Applications

- Cellular
- PCS
- Communication receivers & transmitters

## General Description

Gali<sup>+</sup>33+ (RoHS compliant) is a wideband amplifier offering high dynamic range. Lead finish is SnAgNi. It has repeatable performance from lot to lot, and is enclosed in a SOT-89 package. It uses patented Transient Protected Darlington configuration and is fabricated using InGaP HBT technology. Expected MTTF is 13,000 years at 85°C case temperature. Gali<sup>+</sup>33+ is designed to be rugged for ESD and supply switch-on transients.



**Gali<sup>+</sup>33+**

CASE STYLE: DF782

**+RoHS Compliant**

The +Suffix identifies RoHS Compliance. See our web site for RoHS Compliance methodologies and qualifications

## simplified schematic and pin description



| Function         | Pin Number | Description  |
|------------------|------------|--|
| RF IN            | 1          | RF input pin. This pin requires the use of an external DC blocking capacitor chosen for the frequency of operation.  |
| RF-OUT and DC-IN | 3          | RF output and bias pin. DC voltage is present on this pin; therefore a DC blocking capacitor is necessary for proper operation. An RF choke is needed to feed DC bias without loss of RF signal due to the bias connection, as shown in "Recommended Application Circuit". |
| GND              | 2,4        | Connections to ground. Use via holes as shown in "Suggested Layout for PCB Design" to reduce ground path inductance for best performance.  |

### Notes

- Performance and quality attributes and conditions not expressly stated in this specification document are intended to be excluded and do not form a part of this specification document.
- Electrical specifications and performance data contained in this specification document are based on Mini-Circuit's applicable established test performance criteria and measurement instructions.
- The parts covered by this specification document are subject to Mini-Circuits standard limited warranty and terms and conditions (collectively, "Standard Terms"); Purchasers of this part are entitled to the rights and benefits contained therein. For a full statement of the Standard Terms and the exclusive rights and remedies thereunder, please visit Mini-Circuits' website at [www.minicircuits.com/MCLStore/terms.jsp](http://www.minicircuits.com/MCLStore/terms.jsp)



**Electrical Specifications at 25°C and 40mA, unless noted**

| Parameter   |                | Min. | Typ. | Max. | Units |
|---|----------------|------|------|------|-------|
| Frequency Range*                                  |                | DC   |      | 4    | GHz   |
| Gain  | f=0.1 GHz      | —    | 19.3 | —    | dB    |
|   | f=1 GHz        | —    | 18.7 | —    |       |
|   | f=2 GHz        | 16   | 17.5 | —    |       |
|   | f=3 GHz        | —    | 16.3 | —    |       |
|   | f=4 GHz        | —    | 15.5 | —    |       |
|   | f=6 GHz        | —    | 15.8 | —    |       |
| Input Return Loss                                 | f= DC to 3 GHz |      | 12.5 |      | dB    |
|   | f= 3 to 4 GHz  |      | 9.5  |      |       |
| Output Return Loss                                | f= DC to 3 GHz |      | 21   |      | dB    |
|   | f= 3 to 4 GHz  |      | 17.5 |      |       |
| Output Power @ 1 dB compression                   | f=2 GHz        | 11.4 | 13.4 | —    | dBm   |
| Output IP3  | f=2 GHz        |      | 28   |      | dBm   |
| Noise Figure                                      | f=2 GHz        |      | 3.9  |      | dB    |
| Recommended Device Operating Current              |                |      | 40   |      | mA    |
| Device Operating Voltage                          |                | 3.8  | 4.3  | 4.8  | V     |
| Device Voltage Variation vs. Temperature at 40 mA |                |      | -2.9 |      | mV/°C |
| Device Voltage Variation vs. Current at 25°C      |                |      | 3.8  |      | mV/mA |
| Thermal Resistance, junction-to-case <sup>1</sup> |                |      | 110  |      | °C/W  |

\*Guaranteed specification DC-4 GHz. Low frequency cut off determined by external coupling capacitors.

**Absolute Maximum Ratings**

| Parameter              | Ratings        |
|------------------------|----------------|
| Operating Temperature* | -45°C to 85°C  |
| Storage Temperature    | -65°C to 150°C |
| Operating Current      | 55mA           |
| Input Power            | 13dBm          |

Note: Permanent damage may occur if any of these limits are exceeded.

These ratings are not intended for continuous normal operation.

<sup>1</sup>Case is defined as ground leads.

\*Based on typical case temperature rise 3°C above ambient.

**Notes**

- A. Performance and quality attributes and conditions not expressly stated in this specification document are intended to be excluded and do not form a part of this specification document.
- B. Electrical specifications and performance data contained in this specification document are based on Mini-Circuit's applicable established test performance criteria and measurement instructions.
- C. The parts covered by this specification document are subject to Mini-Circuits standard limited warranty and terms and conditions (collectively, "Standard Terms"); Purchasers of this part are entitled to the rights and benefits contained therein. For a full statement of the Standard Terms and the exclusive rights and remedies thereunder, please visit Mini-Circuits' website at [www.minicircuits.com/MCLStore/terms.jsp](http://www.minicircuits.com/MCLStore/terms.jsp)



### Product Marking

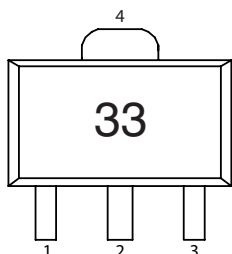

Markings in addition to model number designation may appear for internal quality control purposes.

### Additional Detailed Technical Information

Additional information is available on our web site. To access this information enter the model number on our web site home page.

### Performance data, graphs, s-parameter data set (.zip file)

#### Case Style: DF782

Plastic package, exposed paddle, lead finish: tin-silver over nickel

#### Tape & Reel: F55

7" reels with 20, 50, 100, 200, 500, 1K devices.

#### Suggested Layout for PCB Design: PL-019

#### Evaluation Board: TB-409-33+

#### Environmental Ratings: ENV08T2

### Recommended Application Circuit

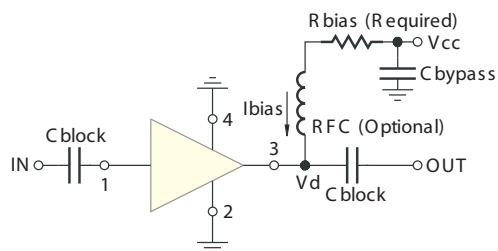

Test Board includes case, connectors, and components (in bold) soldered to PCB

| R BIAS |   |
|--------|---|
| Vcc    | "1%" Res. Values (ohms) for Optimum Biasing |
| 7      | 69.8  |
| 8      | 93.1  |
| 9      | 115   |
| 10     | 140   |
| 11     | 165   |
| 12     | 191   |
| 13     | 215   |
| 14     | 243   |
| 15     | 267   |
| 16     | 287   |
| 17     | 316   |
| 18     | 340   |
| 19     | 365   |
| 20     | 392   |

**Notes**

- A. Performance and quality attributes and conditions not expressly stated in this specification document are intended to be excluded and do not form a part of this specification document.
- B. Electrical specifications and performance data contained in this specification document are based on Mini-Circuit's applicable established test performance criteria and measurement instructions.
- C. The parts covered by this specification document are subject to Mini-Circuits standard limited warranty and terms and conditions (collectively, "Standard Terms"); Purchasers of this part are entitled to the rights and benefits contained therein. For a full statement of the Standard Terms and the exclusive rights and remedies thereunder, please visit Mini-Circuits' website at [www.minicircuits.com/MCLStore/terms.jsp](http://www.minicircuits.com/MCLStore/terms.jsp)



**ESD Rating**

Human Body Model (HBM): Class 1B (500v to < 1000v) in accordance with ANSI/ESD STM 5.1 - 2001

Machine Model (MM): Class M1 (< 100v) in accordance with ANSI/ESD STM 5.2 - 1999

**MSL Rating**

Moisture Sensitivity: MSL1 in accordance with IPC/JEDECJ-STD-020C

| No. | Test Required                | Condition   | Standard                    | Quantity |
|-----|------------------------------|---|-----------------------------|----------|
| 1   | Visual Inspection            | Low Power Microscope Magnification 40x  | MIP-IN-0003 (MCT spec)      | 45 units |
| 2   | Electrical Test              | Room Temperature  | SCD (MCL spec)              | 45 units |
| 3   | SAM Analysis                 | Less than 10% growth in term of delamination  | J-Std-020C (Jedec Standard) | 45 units |
| 4   | Moisture Sensitivity Level 1 | Bake at 125°C for 24 hours<br>Soak at 85°C/85%RH for 168 hours<br>Reflow 3 cycles at 260°C peak | J-Std-020C (Jedec Standard) | 45 units |

**MSL Test Flow Chart**



**Notes**

- A. Performance and quality attributes and conditions not expressly stated in this specification document are intended to be excluded and do not form a part of this specification document.
- B. Electrical specifications and performance data contained in this specification document are based on Mini-Circuit's applicable established test performance criteria and measurement instructions.
- C. The parts covered by this specification document are subject to Mini-Circuits standard limited warranty and terms and conditions (collectively, "Standard Terms"); Purchasers of this part are entitled to the rights and benefits contained therein. For a full statement of the Standard Terms and the exclusive rights and remedies thereunder, please visit Mini-Circuits' website at [www.minicircuits.com/MCLStore/terms.jsp](http://www.minicircuits.com/MCLStore/terms.jsp)



## Typical Performance Data

**NOTE: Use PDF Bookmarks to view DATA at required conditions  
or to view GRAPHS.**

**Definitions:**

Input Return Loss = -S11 (dB)

Gain(Power Gain) = S21 (dB)

Reverse Isolation = -S12 (dB)

Output Return Loss = -S22 (dB)

TEST CONDITIONS: INPUT POWER = -25dBm, Icc = 40mA, Vd = 4.26V @Temperature = +25degC

| FREQ  | Gain  | Isolation | Input Return Loss | Output Return Loss | Stability |       | FREQ  | IP3 Output | 1dB Comp. Output | Noise Figure |
|-------|-------|-----------|-------------------|--------------------|-----------|-------|-------|------------|------------------|--------------|
| (MHz) | (dB)  | (dB)      | (dB)              | (dB)               | K         | Delta | (MHz) | (dBm)      | (dBm)            | (dB)         |
| 50    | 19.83 | 22.56     | 31.21             | 26.25              | 1.05      | 0.73  | 50    | 28.26      | 14.52            | 3.04         |
| 100   | 19.80 | 21.89     | 39.46             | 27.86              | 1.03      | 0.79  | 100   | 27.93      | 14.22            | 3.18         |
| 150   | 19.81 | 22.16     | 32.30             | 27.06              | 1.04      | 0.76  | 200   | 28.68      | 14.33            | 3.01         |
| 200   | 19.80 | 22.24     | 29.43             | 27.70              | 1.04      | 0.76  | 300   | 28.26      | 14.32            | 3.09         |
| 300   | 19.70 | 22.15     | 27.57             | 27.80              | 1.04      | 0.75  | 400   | 28.13      | 14.38            | 3.02         |
| 400   | 19.71 | 22.17     | 26.09             | 26.99              | 1.04      | 0.76  | 500   | 27.80      | 14.37            | 3.11         |
| 500   | 19.64 | 21.95     | 24.72             | 26.91              | 1.03      | 0.77  | 600   | 27.69      | 14.19            | 3.04         |
| 600   | 19.66 | 22.02     | 22.23             | 26.83              | 1.03      | 0.77  | 700   | 27.97      | 14.14            | 3.19         |
| 700   | 19.54 | 22.16     | 21.93             | 26.61              | 1.04      | 0.74  | 800   | 28.48      | 13.81            | 3.09         |
| 800   | 19.50 | 22.11     | 20.45             | 25.81              | 1.04      | 0.74  | 900   | 28.28      | 13.73            | 3.12         |
| 1000  | 19.38 | 22.12     | 18.72             | 25.00              | 1.05      | 0.74  | 1000  | 27.76      | 13.63            | 3.02         |
| 1200  | 19.23 | 22.32     | 17.72             | 23.30              | 1.06      | 0.71  | 1100  | 28.06      | 13.80            | 3.08         |
| 1400  | 19.07 | 22.39     | 16.50             | 21.85              | 1.06      | 0.69  | 1200  | 28.13      | 13.76            | 3.08         |
| 1600  | 18.92 | 22.52     | 15.66             | 20.56              | 1.08      | 0.68  | 1300  | 27.81      | 13.68            | 3.08         |
| 1800  | 18.77 | 22.70     | 14.87             | 19.17              | 1.09      | 0.66  | 1400  | 27.57      | 13.75            | 3.07         |
| 2000  | 18.58 | 22.86     | 14.12             | 18.03              | 1.10      | 0.63  | 1500  | 27.48      | 13.44            | 3.10         |
| 2200  | 18.39 | 22.99     | 13.59             | 17.19              | 1.12      | 0.62  | 1600  | 27.78      | 13.57            | 3.14         |
| 2400  | 18.23 | 23.06     | 13.00             | 16.37              | 1.13      | 0.61  | 1700  | 28.20      | 13.31            | 3.02         |
| 2600  | 18.05 | 23.20     | 12.29             | 15.68              | 1.14      | 0.59  | 1800  | 27.88      | 13.57            | 3.09         |
| 2800  | 17.84 | 23.46     | 12.01             | 15.18              | 1.17      | 0.56  | 1900  | 27.34      | 13.39            | 3.08         |
| 3000  | 17.73 | 23.56     | 11.64             | 14.79              | 1.18      | 0.55  | 2000  | 27.00      | 13.28            | 3.10         |
| 3200  | 17.55 | 23.73     | 11.24             | 14.56              | 1.20      | 0.54  | 2100  | 26.76      | 13.13            | 3.06         |
| 3400  | 17.47 | 23.91     | 10.79             | 14.44              | 1.21      | 0.52  | 2200  | 26.40      | 12.69            | 3.05         |
| 3600  | 17.35 | 24.06     | 10.62             | 14.18              | 1.23      | 0.51  | 2300  | 26.29      | 12.67            | 3.02         |
| 3800  | 17.23 | 24.26     | 10.51             | 14.16              | 1.25      | 0.49  | 2400  | 25.93      | 12.54            | 3.10         |
| 4000  | 17.15 | 24.35     | 10.42             | 14.24              | 1.26      | 0.48  | 2500  | 25.49      | 12.75            | 3.06         |
| 4200  | 17.12 | 24.52     | 10.23             | 14.31              | 1.27      | 0.47  | 2600  | 25.32      | 12.59            | 3.19         |
| 4400  | 17.05 | 24.53     | 10.39             | 14.10              | 1.28      | 0.46  | 2700  | 24.93      | 12.52            | 3.08         |
| 4600  | 17.09 | 24.83     | 10.38             | 13.75              | 1.30      | 0.44  | 2800  | 24.69      | 12.44            | 3.15         |
| 5000  | 17.05 | 24.90     | 10.87             | 12.88              | 1.30      | 0.43  | 2900  | 24.25      | 12.36            | 3.11         |
| 5500  | 17.10 | 24.92     | 11.97             | 11.05              | 1.27      | 0.42  | 3000  | 24.00      | 12.23            | 3.16         |
| 6000  | 17.23 | 24.60     | 14.11             | 9.26               | 1.20      | 0.43  | 3100  | 23.60      | 11.60            | 3.10         |
| 6500  | 17.43 | 24.58     | 17.35             | 7.46               | 1.11      | 0.42  | 3200  | 23.18      | 12.03            | 3.19         |
| 7000  | 17.20 | 24.21     | 22.41             | 6.14               | 1.03      | 0.41  | 3300  | 22.85      | 11.95            | 3.19         |
| 7500  | 16.14 | 23.96     | 19.10             | 5.44               | 1.05      | 0.39  | 3400  | 22.52      | 11.94            | 3.24         |
| 8000  | 14.16 | 23.88     | 14.43             | 5.34               | 1.20      | 0.34  | 3500  | 22.40      | 11.48            | 3.17         |
| 8500  | 11.98 | 24.44     | 11.88             | 5.36               | 1.51      | 0.28  | 3600  | 22.21      | 11.31            | 3.23         |
| 9000  | 9.71  | 23.57     | 10.79             | 5.68               | 1.73      | 0.23  | 3700  | 21.97      | 11.42            | 3.11         |
| 9500  | 7.77  | 22.80     | 9.89              | 5.95               | 1.92      | 0.19  | 3800  | 21.78      | 10.98            | 3.18         |
| 10000 | 6.09  | 21.44     | 9.08              | 5.97               | 1.90      | 0.16  | 4000  | 21.22      | 10.64            | 3.13         |

REV. X1  
GALI-33+  
080127

Page 1 of 11



IF/RF MICROWAVE COMPONENTS • ISO 9001 ISO 14001 AS 9100 CERTIFIED • RoHS compliant

P.O. Box 350166, Brooklyn, New York 11235-0003 (718) 934-4500 Fax (718) 332-4661



The Design Engineers Search Engine finds the model you need, Instantly • For detailed performance specs & shopping online see



## Typical Performance Data

### Definitions:

Input Return Loss = -S11 (dB)

Gain(Power Gain) = S21 (dB)

Reverse Isolation = -S12 (dB)

Output Return Loss = -S22 (dB)

TEST CONDITIONS: INPUT POWER = -25dBm, Icc = 32mA, Vd = 4.21V @Temperature = +25degC

| FREQ  | Gain  | Isolation | Input Return Loss | Output Return Loss | Stability |       | FREQ  | IP3 Output | 1dB Comp. Output | Noise Figure |
|-------|-------|-----------|-------------------|--------------------|-----------|-------|-------|------------|------------------|--------------|
| (MHz) | (dB)  | (dB)      | (dB)              | (dB)               | K         | Delta | (MHz) | (dBm)      | (dBm)            | (dB)         |
| 50    | 19.46 | 21.91     | 26.07             | 20.92              | 1.04      | 0.76  | 50    | 24.60      | 11.56            | 3.06         |
| 100   | 19.42 | 22.25     | 31.49             | 22.54              | 1.05      | 0.72  | 100   | 24.30      | 11.11            | 3.12         |
| 150   | 19.42 | 21.83     | 25.21             | 22.19              | 1.04      | 0.76  | 200   | 24.90      | 11.44            | 3.03         |
| 200   | 19.40 | 21.63     | 26.68             | 21.91              | 1.03      | 0.78  | 300   | 24.51      | 11.45            | 3.04         |
| 300   | 19.33 | 22.05     | 25.50             | 22.22              | 1.05      | 0.73  | 400   | 24.40      | 11.38            | 3.03         |
| 400   | 19.32 | 21.80     | 23.96             | 22.04              | 1.04      | 0.76  | 500   | 24.11      | 11.46            | 3.08         |
| 500   | 19.27 | 21.73     | 23.71             | 22.05              | 1.04      | 0.76  | 600   | 24.07      | 11.25            | 3.05         |
| 600   | 19.31 | 21.79     | 21.71             | 22.54              | 1.04      | 0.76  | 700   | 24.27      | 11.30            | 3.17         |
| 700   | 19.20 | 21.77     | 21.58             | 22.49              | 1.04      | 0.75  | 800   | 24.71      | 10.86            | 3.08         |
| 800   | 19.15 | 21.94     | 20.03             | 22.03              | 1.05      | 0.73  | 900   | 24.56      | 10.90            | 3.10         |
| 1000  | 19.03 | 21.98     | 18.63             | 21.75              | 1.05      | 0.72  | 1000  | 24.10      | 10.81            | 3.01         |
| 1200  | 18.88 | 22.05     | 17.62             | 20.88              | 1.06      | 0.71  | 1100  | 24.43      | 11.02            | 3.07         |
| 1400  | 18.73 | 22.24     | 16.46             | 19.81              | 1.07      | 0.68  | 1200  | 24.50      | 10.76            | 3.05         |
| 1600  | 18.59 | 22.40     | 15.65             | 18.91              | 1.09      | 0.66  | 1300  | 24.27      | 10.83            | 3.06         |
| 1800  | 18.45 | 22.48     | 14.80             | 17.67              | 1.09      | 0.65  | 1400  | 24.17      | 10.98            | 3.07         |
| 2000  | 18.28 | 22.61     | 14.01             | 16.63              | 1.10      | 0.64  | 1500  | 24.17      | 10.73            | 3.10         |
| 2200  | 18.10 | 22.76     | 13.45             | 15.86              | 1.12      | 0.62  | 1600  | 24.47      | 10.87            | 3.13         |
| 2400  | 17.96 | 22.85     | 12.82             | 15.16              | 1.13      | 0.61  | 1700  | 24.81      | 10.55            | 3.02         |
| 2600  | 17.78 | 23.18     | 12.13             | 14.53              | 1.15      | 0.58  | 1800  | 24.64      | 10.90            | 3.03         |
| 2800  | 17.58 | 23.22     | 11.83             | 13.98              | 1.17      | 0.57  | 1900  | 24.27      | 10.73            | 3.06         |
| 3000  | 17.48 | 23.37     | 11.44             | 13.60              | 1.18      | 0.56  | 2000  | 24.10      | 10.69            | 3.07         |
| 3200  | 17.31 | 23.61     | 11.00             | 13.54              | 1.20      | 0.54  | 2100  | 23.91      | 10.52            | 3.06         |
| 3400  | 17.24 | 23.80     | 10.59             | 13.48              | 1.21      | 0.52  | 2200  | 23.73      | 10.10            | 2.99         |
| 3600  | 17.13 | 23.93     | 10.38             | 13.19              | 1.23      | 0.51  | 2300  | 23.69      | 10.06            | 3.02         |
| 3800  | 17.02 | 23.90     | 10.28             | 13.11              | 1.23      | 0.50  | 2400  | 23.48      | 9.92             | 3.05         |
| 4000  | 16.94 | 24.25     | 10.21             | 13.15              | 1.26      | 0.48  | 2500  | 23.22      | 10.30            | 3.07         |
| 4200  | 16.92 | 24.33     | 10.04             | 13.14              | 1.26      | 0.47  | 2600  | 23.30      | 10.01            | 3.15         |
| 4400  | 16.86 | 24.46     | 10.17             | 13.03              | 1.28      | 0.46  | 2700  | 23.06      | 10.23            | 3.09         |
| 4600  | 16.92 | 24.45     | 10.14             | 12.85              | 1.26      | 0.46  | 2800  | 22.95      | 10.23            | 3.14         |
| 5000  | 16.88 | 24.66     | 10.70             | 12.04              | 1.27      | 0.43  | 2900  | 22.64      | 10.18            | 3.08         |
| 5500  | 16.96 | 24.62     | 11.83             | 10.40              | 1.24      | 0.43  | 3000  | 22.48      | 10.03            | 3.16         |
| 6000  | 17.08 | 24.36     | 13.97             | 8.70               | 1.16      | 0.43  | 3100  | 22.14      | 9.64             | 3.09         |
| 6500  | 17.29 | 24.20     | 16.84             | 7.01               | 1.06      | 0.42  | 3200  | 21.80      | 10.11            | 3.16         |
| 7000  | 17.02 | 23.76     | 20.53             | 5.82               | 0.98      | 0.41  | 3300  | 21.59      | 10.11            | 3.16         |
| 7500  | 15.94 | 23.58     | 17.85             | 5.20               | 1.00      | 0.38  | 3400  | 21.30      | 10.25            | 3.23         |
| 8000  | 13.94 | 23.69     | 13.95             | 5.18               | 1.17      | 0.32  | 3500  | 21.25      | 9.95             | 3.15         |
| 8500  | 11.74 | 24.15     | 11.67             | 5.24               | 1.47      | 0.27  | 3600  | 21.10      | 9.81             | 3.23         |
| 9000  | 9.45  | 23.40     | 10.60             | 5.56               | 1.71      | 0.22  | 3700  | 20.90      | 9.79             | 3.08         |
| 9500  | 7.54  | 22.70     | 9.76              | 5.87               | 1.92      | 0.19  | 3800  | 20.76      | 9.52             | 3.11         |
| 10000 | 5.93  | 21.30     | 8.94              | 5.86               | 1.88      | 0.16  | 4000  | 20.27      | 9.49             | 3.11         |

REV. X1  
GALI-33+  
080127

Page 2 of 11



IF/RF MICROWAVE COMPONENTS • ISO 9001 ISO 14001 AS 9100 CERTIFIED • RoHS compliant

P.O. Box 350166, Brooklyn, New York 11235-0003 (718) 934-4500 Fax (718) 332-4661



The Design Engineers Search Engine finds the model you need, Instantly • For detailed performance specs & shopping online see



## Typical Performance Data

### Definitions:

Input Return Loss = -S11 (dB)

Gain(Power Gain) = S21 (dB)

Reverse Isolation = -S12 (dB)

Output Return Loss = -S22 (dB)

TEST CONDITIONS: INPUT POWER = -25dBm, Icc = 48mA, Vd = 4.30V @Temperature = +25degC

| FREQ  | Gain  | Isolation | Input Return Loss | Output Return Loss | Stability |       | FREQ  | IP3 Output | 1dB Comp. Output | Noise Figure |
|-------|-------|-----------|-------------------|--------------------|-----------|-------|-------|------------|------------------|--------------|
| (MHz) | (dB)  | (dB)      | (dB)              | (dB)               | K         | Delta | (MHz) | (dBm)      | (dBm)            | (dB)         |
| 50    | 20.09 | 21.77     | 27.94             | 31.29              | 1.02      | 0.82  | 50    | 31.25      | 16.64            | 3.10         |
| 100   | 20.05 | 22.07     | 32.45             | 34.92              | 1.03      | 0.79  | 100   | 30.88      | 16.39            | 3.20         |
| 150   | 20.05 | 22.21     | 34.69             | 32.73              | 1.03      | 0.78  | 200   | 31.86      | 16.52            | 3.02         |
| 200   | 20.02 | 22.21     | 28.77             | 33.53              | 1.03      | 0.78  | 300   | 31.43      | 16.48            | 3.14         |
| 300   | 19.96 | 22.14     | 27.27             | 32.60              | 1.03      | 0.78  | 400   | 31.28      | 16.44            | 3.04         |
| 400   | 19.95 | 22.20     | 25.50             | 31.53              | 1.03      | 0.77  | 500   | 30.89      | 16.47            | 3.16         |
| 500   | 19.90 | 22.26     | 24.03             | 30.84              | 1.04      | 0.76  | 600   | 30.78      | 16.33            | 3.06         |
| 600   | 19.89 | 22.20     | 21.89             | 30.46              | 1.03      | 0.77  | 700   | 31.06      | 16.19            | 3.23         |
| 700   | 19.75 | 22.35     | 21.55             | 29.63              | 1.04      | 0.74  | 800   | 31.68      | 15.94            | 3.11         |
| 800   | 19.74 | 22.35     | 20.24             | 28.00              | 1.04      | 0.74  | 900   | 31.42      | 15.88            | 3.15         |
| 1000  | 19.59 | 22.42     | 18.54             | 26.43              | 1.05      | 0.73  | 1000  | 30.74      | 15.73            | 3.05         |
| 1200  | 19.45 | 22.49     | 17.58             | 24.48              | 1.05      | 0.71  | 1100  | 31.14      | 15.86            | 3.10         |
| 1400  | 19.28 | 22.61     | 16.43             | 22.72              | 1.06      | 0.69  | 1200  | 31.06      | 15.81            | 3.11         |
| 1600  | 19.10 | 22.75     | 15.59             | 21.39              | 1.08      | 0.67  | 1300  | 30.67      | 15.65            | 3.11         |
| 1800  | 18.94 | 22.73     | 14.86             | 19.94              | 1.08      | 0.66  | 1400  | 30.24      | 15.68            | 3.13         |
| 2000  | 18.77 | 23.04     | 14.19             | 18.74              | 1.10      | 0.63  | 1500  | 29.97      | 15.43            | 3.12         |
| 2200  | 18.57 | 23.14     | 13.65             | 17.91              | 1.12      | 0.62  | 1600  | 30.16      | 15.49            | 3.17         |
| 2400  | 18.43 | 23.17     | 13.07             | 17.05              | 1.12      | 0.61  | 1700  | 30.63      | 15.20            | 3.02         |
| 2600  | 18.23 | 23.50     | 12.44             | 16.37              | 1.15      | 0.58  | 1800  | 30.17      | 15.35            | 3.10         |
| 2800  | 18.04 | 23.55     | 12.17             | 15.86              | 1.16      | 0.57  | 1900  | 29.48      | 15.27            | 3.06         |
| 3000  | 17.90 | 23.56     | 11.80             | 15.41              | 1.17      | 0.56  | 2000  | 29.09      | 15.09            | 3.15         |
| 3200  | 17.70 | 23.84     | 11.38             | 15.25              | 1.20      | 0.53  | 2100  | 28.67      | 14.91            | 3.08         |
| 3400  | 17.62 | 24.03     | 10.95             | 15.18              | 1.21      | 0.52  | 2200  | 28.22      | 14.59            | 3.09         |
| 3600  | 17.48 | 24.15     | 10.77             | 14.93              | 1.23      | 0.51  | 2300  | 27.95      | 14.42            | 3.03         |
| 3800  | 17.37 | 24.43     | 10.66             | 14.89              | 1.26      | 0.48  | 2400  | 27.43      | 14.28            | 3.14         |
| 4000  | 17.29 | 24.47     | 10.58             | 14.90              | 1.27      | 0.48  | 2500  | 26.94      | 14.32            | 3.10         |
| 4200  | 17.26 | 24.62     | 10.36             | 14.88              | 1.27      | 0.47  | 2600  | 26.50      | 13.95            | 3.21         |
| 4400  | 17.19 | 24.66     | 10.56             | 14.72              | 1.28      | 0.46  | 2700  | 26.08      | 13.72            | 3.11         |
| 4600  | 17.20 | 24.86     | 10.49             | 14.34              | 1.29      | 0.44  | 2800  | 25.69      | 13.69            | 3.21         |
| 5000  | 17.18 | 24.96     | 10.98             | 13.36              | 1.30      | 0.43  | 2900  | 25.23      | 13.48            | 3.12         |
| 5500  | 17.25 | 25.19     | 12.03             | 11.45              | 1.29      | 0.42  | 3000  | 24.91      | 13.35            | 3.20         |
| 6000  | 17.40 | 24.96     | 14.10             | 9.53               | 1.23      | 0.42  | 3100  | 24.51      | 12.57            | 3.14         |
| 6500  | 17.61 | 24.78     | 17.51             | 7.60               | 1.13      | 0.42  | 3200  | 24.09      | 12.97            | 3.21         |
| 7000  | 17.39 | 24.38     | 24.15             | 6.25               | 1.04      | 0.42  | 3300  | 23.66      | 12.87            | 3.23         |
| 7500  | 16.38 | 24.18     | 19.96             | 5.47               | 1.06      | 0.40  | 3400  | 23.30      | 12.72            | 3.25         |
| 8000  | 14.40 | 24.26     | 14.78             | 5.37               | 1.23      | 0.34  | 3500  | 23.16      | 12.37            | 3.20         |
| 8500  | 12.21 | 24.69     | 12.25             | 5.45               | 1.55      | 0.28  | 3600  | 22.91      | 12.13            | 3.29         |
| 9000  | 9.93  | 23.79     | 10.97             | 5.70               | 1.75      | 0.24  | 3700  | 22.70      | 12.23            | 3.16         |
| 9500  | 8.02  | 22.89     | 10.01             | 5.97               | 1.91      | 0.20  | 3800  | 22.53      | 11.70            | 3.19         |
| 10000 | 6.39  | 21.39     | 9.14              | 5.95               | 1.84      | 0.17  | 4000  | 21.97      | 11.35            | 3.15         |

## Typical Performance Data

### Definitions:

Input Return Loss = -S11 (dB)

Gain(Power Gain) = S21 (dB)

Reverse Isolation = -S12 (dB)

Output Return Loss = -S22 (dB)

TEST CONDITIONS: INPUT POWER = -25dBm, Icc = 40mA, Vd = 4.48V @Temperature = -45degC

| FREQ  | Gain  | Isolation | Input Return Loss | Output Return Loss | Stability |       | FREQ  | IP3 Output | 1dB Comp. Output | Noise Figure |
|-------|-------|-----------|-------------------|--------------------|-----------|-------|-------|------------|------------------|--------------|
| (MHz) | (dB)  | (dB)      | (dB)              | (dB)               | K         | Delta | (MHz) | (dBm)      | (dBm)            | (dB)         |
| 50    | 19.83 | 21.43     | 30.25             | 25.60              | 1.01      | 0.83  | 50    | 28.87      | 14.39            | 2.73         |
| 100   | 19.83 | 22.03     | 39.21             | 28.51              | 1.03      | 0.78  | 100   | 28.66      | 14.02            | 2.81         |
| 150   | 19.85 | 21.96     | 33.57             | 26.21              | 1.03      | 0.79  | 200   | 29.60      | 14.08            | 2.60         |
| 200   | 19.83 | 22.20     | 29.35             | 26.33              | 1.04      | 0.76  | 300   | 29.32      | 14.15            | 2.63         |
| 300   | 19.76 | 21.99     | 27.45             | 27.56              | 1.03      | 0.77  | 400   | 29.34      | 14.20            | 2.57         |
| 400   | 19.73 | 21.87     | 25.89             | 27.49              | 1.03      | 0.78  | 500   | 29.10      | 14.12            | 2.65         |
| 500   | 19.69 | 22.05     | 24.58             | 26.99              | 1.04      | 0.76  | 600   | 29.14      | 14.03            | 2.59         |
| 600   | 19.68 | 22.08     | 22.25             | 26.84              | 1.04      | 0.76  | 700   | 29.50      | 13.91            | 2.71         |
| 700   | 19.57 | 22.13     | 21.76             | 26.63              | 1.04      | 0.75  | 800   | 30.11      | 13.71            | 2.60         |
| 800   | 19.52 | 22.00     | 20.44             | 26.13              | 1.04      | 0.76  | 900   | 29.89      | 13.63            | 2.65         |
| 1000  | 19.42 | 22.15     | 18.74             | 25.36              | 1.04      | 0.74  | 1000  | 29.36      | 13.59            | 2.52         |
| 1200  | 19.27 | 22.25     | 17.48             | 23.31              | 1.05      | 0.72  | 1100  | 29.79      | 13.76            | 2.58         |
| 1400  | 19.11 | 22.32     | 16.45             | 21.93              | 1.06      | 0.70  | 1200  | 29.89      | 13.69            | 2.56         |
| 1600  | 18.94 | 22.54     | 15.66             | 20.72              | 1.08      | 0.68  | 1300  | 29.72      | 13.59            | 2.59         |
| 1800  | 18.77 | 22.56     | 14.79             | 19.13              | 1.08      | 0.67  | 1400  | 29.42      | 13.66            | 2.57         |
| 2000  | 18.60 | 22.68     | 13.95             | 18.12              | 1.09      | 0.65  | 1500  | 29.40      | 13.41            | 2.60         |
| 2200  | 18.39 | 22.76     | 13.50             | 17.40              | 1.10      | 0.63  | 1600  | 29.79      | 13.60            | 2.63         |
| 2400  | 18.28 | 23.01     | 13.02             | 16.56              | 1.12      | 0.61  | 1700  | 30.33      | 13.23            | 2.48         |
| 2600  | 18.04 | 23.10     | 12.14             | 15.80              | 1.13      | 0.60  | 1800  | 30.11      | 13.56            | 2.56         |
| 2800  | 17.86 | 23.42     | 11.99             | 15.30              | 1.16      | 0.57  | 1900  | 29.63      | 13.52            | 2.54         |
| 3000  | 17.73 | 23.42     | 11.47             | 15.02              | 1.17      | 0.56  | 2000  | 29.31      | 13.42            | 2.59         |
| 3200  | 17.49 | 23.68     | 11.20             | 15.11              | 1.20      | 0.53  | 2100  | 29.05      | 13.23            | 2.54         |
| 3400  | 17.48 | 23.82     | 10.83             | 14.69              | 1.21      | 0.53  | 2200  | 28.71      | 12.90            | 2.51         |
| 3600  | 17.37 | 24.05     | 10.48             | 14.36              | 1.22      | 0.51  | 2300  | 28.60      | 12.73            | 2.50         |
| 3800  | 17.24 | 24.19     | 10.26             | 14.37              | 1.24      | 0.50  | 2400  | 28.30      | 12.74            | 2.51         |
| 4000  | 17.19 | 24.44     | 10.38             | 14.46              | 1.27      | 0.48  | 2500  | 27.97      | 12.91            | 2.53         |
| 4200  | 17.13 | 24.60     | 10.00             | 14.50              | 1.28      | 0.47  | 2600  | 27.83      | 12.75            | 2.63         |
| 4400  | 17.13 | 24.74     | 10.09             | 13.80              | 1.28      | 0.46  | 2700  | 27.50      | 12.76            | 2.52         |
| 4600  | 17.02 | 24.76     | 10.22             | 13.91              | 1.30      | 0.45  | 2800  | 27.29      | 12.82            | 2.63         |
| 5000  | 17.06 | 25.16     | 10.20             | 12.98              | 1.32      | 0.43  | 2900  | 27.01      | 12.78            | 2.54         |
| 5500  | 17.02 | 24.99     | 11.39             | 10.90              | 1.28      | 0.42  | 3000  | 26.64      | 12.64            | 2.63         |
| 6000  | 17.18 | 24.80     | 12.43             | 9.31               | 1.21      | 0.43  | 3100  | 26.29      | 12.21            | 2.53         |
| 6500  | 17.68 | 24.79     | 13.69             | 7.57               | 1.11      | 0.45  | 3200  | 25.85      | 12.48            | 2.62         |
| 7000  | 17.70 | 24.65     | 20.01             | 5.48               | 1.00      | 0.44  | 3300  | 25.45      | 12.44            | 2.67         |
| 7500  | 17.21 | 24.22     | 39.18             | 4.32               | 0.93      | 0.45  | 3400  | 24.98      | 12.45            | 2.68         |
| 8000  | 15.57 | 24.25     | 18.49             | 4.13               | 1.01      | 0.38  | 3500  | 24.80      | 12.10            | 2.61         |
| 8500  | 13.30 | 23.00     | 15.38             | 5.02               | 1.17      | 0.33  | 3600  | 24.62      | 11.99            | 2.68         |
| 9000  | 11.25 | 23.94     | 13.87             | 5.52               | 1.62      | 0.27  | 3700  | 24.35      | 12.13            | 2.55         |
| 9500  | 9.41  | 22.15     | 11.56             | 5.36               | 1.50      | 0.23  | 3800  | 24.20      | 11.82            | 2.59         |
| 10000 | 7.64  | 20.99     | 10.18             | 5.77               | 1.57      | 0.19  | 4000  | 23.59      | 11.63            | 2.58         |



## Typical Performance Data

### Definitions:

Input Return Loss = -S11 (dB)

Gain(Power Gain) = S21 (dB)

Reverse Isolation = -S12 (dB)

Output Return Loss = -S22 (dB)

TEST CONDITIONS: INPUT POWER = -25dBm, Icc = 32mA, Vd = 4.43V @Temperature = -45degC

| FREQ  | Gain  | Isolation | Input Return Loss | Output Return Loss | Stability |       | FREQ  | IP3 Output | 1dB Comp. Output | Noise Figure |
|-------|-------|-----------|-------------------|--------------------|-----------|-------|-------|------------|------------------|--------------|
| (MHz) | (dB)  | (dB)      | (dB)              | (dB)               | K         | Delta | (MHz) | (dBm)      | (dBm)            | (dB)         |
| 50    | 19.54 | 21.83     | 25.73             | 22.59              | 1.03      | 0.77  | 50    | 25.01      | 11.44            | 2.72         |
| 100   | 19.49 | 21.50     | 32.18             | 23.52              | 1.03      | 0.79  | 100   | 24.75      | 11.04            | 2.75         |
| 150   | 19.50 | 21.49     | 25.80             | 22.42              | 1.03      | 0.80  | 200   | 25.35      | 11.18            | 2.60         |
| 200   | 19.48 | 21.74     | 26.64             | 22.64              | 1.03      | 0.77  | 300   | 25.07      | 11.20            | 2.58         |
| 300   | 19.40 | 21.60     | 25.57             | 23.08              | 1.03      | 0.78  | 400   | 25.07      | 11.21            | 2.57         |
| 400   | 19.41 | 21.79     | 24.88             | 22.99              | 1.04      | 0.76  | 500   | 24.86      | 11.28            | 2.59         |
| 500   | 19.36 | 21.67     | 24.11             | 22.66              | 1.03      | 0.77  | 600   | 24.86      | 11.12            | 2.59         |
| 600   | 19.36 | 21.84     | 21.68             | 23.10              | 1.04      | 0.76  | 700   | 25.11      | 11.06            | 2.67         |
| 700   | 19.25 | 21.75     | 21.74             | 22.88              | 1.04      | 0.75  | 800   | 25.55      | 10.82            | 2.58         |
| 800   | 19.25 | 21.83     | 20.22             | 23.00              | 1.04      | 0.75  | 900   | 25.36      | 10.78            | 2.59         |
| 1000  | 19.10 | 22.00     | 18.70             | 22.85              | 1.05      | 0.72  | 1000  | 25.01      | 10.67            | 2.50         |
| 1200  | 18.97 | 21.98     | 17.59             | 21.53              | 1.05      | 0.72  | 1100  | 25.32      | 10.90            | 2.58         |
| 1400  | 18.82 | 22.17     | 16.44             | 20.46              | 1.07      | 0.69  | 1200  | 25.41      | 10.92            | 2.54         |
| 1600  | 18.68 | 22.27     | 15.75             | 19.59              | 1.08      | 0.68  | 1300  | 25.20      | 10.78            | 2.57         |
| 1800  | 18.53 | 22.30     | 14.78             | 18.05              | 1.08      | 0.67  | 1400  | 25.13      | 10.86            | 2.55         |
| 2000  | 18.36 | 22.51     | 13.90             | 17.12              | 1.10      | 0.65  | 1500  | 25.16      | 10.53            | 2.59         |
| 2200  | 18.18 | 22.74     | 13.44             | 16.30              | 1.11      | 0.62  | 1600  | 25.55      | 10.82            | 2.60         |
| 2400  | 18.02 | 22.80     | 12.92             | 15.70              | 1.12      | 0.61  | 1700  | 25.90      | 10.52            | 2.48         |
| 2600  | 17.83 | 23.05     | 12.07             | 14.92              | 1.14      | 0.59  | 1800  | 25.81      | 10.89            | 2.53         |
| 2800  | 17.63 | 23.19     | 11.89             | 14.44              | 1.16      | 0.57  | 1900  | 25.51      | 10.74            | 2.54         |
| 3000  | 17.50 | 23.28     | 11.37             | 14.06              | 1.17      | 0.56  | 2000  | 25.38      | 10.69            | 2.54         |
| 3200  | 17.29 | 23.53     | 11.08             | 14.14              | 1.20      | 0.54  | 2100  | 25.29      | 10.53            | 2.55         |
| 3400  | 17.27 | 23.68     | 10.66             | 13.77              | 1.20      | 0.53  | 2200  | 25.08      | 10.12            | 2.46         |
| 3600  | 17.17 | 23.82     | 10.32             | 13.51              | 1.22      | 0.52  | 2300  | 25.09      | 10.00            | 2.48         |
| 3800  | 17.05 | 24.12     | 10.11             | 13.51              | 1.25      | 0.50  | 2400  | 24.96      | 9.95             | 2.51         |
| 4000  | 16.99 | 24.19     | 10.26             | 13.54              | 1.26      | 0.49  | 2500  | 24.77      | 10.16            | 2.52         |
| 4200  | 16.96 | 24.39     | 9.85              | 13.57              | 1.27      | 0.47  | 2600  | 24.91      | 10.17            | 2.60         |
| 4400  | 16.95 | 24.49     | 9.92              | 13.03              | 1.27      | 0.47  | 2700  | 24.83      | 10.25            | 2.51         |
| 4600  | 16.85 | 24.66     | 10.18             | 13.11              | 1.30      | 0.45  | 2800  | 24.85      | 10.28            | 2.60         |
| 5000  | 16.92 | 25.01     | 10.11             | 12.32              | 1.31      | 0.43  | 2900  | 24.61      | 10.18            | 2.53         |
| 5500  | 16.87 | 24.76     | 11.35             | 10.43              | 1.26      | 0.43  | 3000  | 24.42      | 10.19            | 2.60         |
| 6000  | 17.02 | 24.58     | 12.33             | 8.89               | 1.19      | 0.43  | 3100  | 24.18      | 9.85             | 2.53         |
| 6500  | 17.50 | 24.47     | 14.15             | 7.18               | 1.09      | 0.45  | 3200  | 23.87      | 10.22            | 2.60         |
| 7000  | 17.57 | 24.25     | 19.47             | 5.28               | 0.96      | 0.44  | 3300  | 23.62      | 10.14            | 2.65         |
| 7500  | 17.01 | 24.01     | 31.64             | 4.12               | 0.90      | 0.44  | 3400  | 23.31      | 10.43            | 2.67         |
| 8000  | 15.35 | 23.79     | 17.97             | 4.12               | 0.97      | 0.38  | 3500  | 23.29      | 10.17            | 2.59         |
| 8500  | 13.08 | 22.98     | 14.98             | 4.98               | 1.18      | 0.32  | 3600  | 23.13      | 10.11            | 2.65         |
| 9000  | 11.13 | 24.32     | 13.29             | 5.22               | 1.64      | 0.26  | 3700  | 22.93      | 10.05            | 2.52         |
| 9500  | 9.20  | 21.94     | 11.29             | 5.23               | 1.46      | 0.22  | 3800  | 22.84      | 9.95             | 2.59         |
| 10000 | 7.37  | 20.93     | 10.07             | 5.87               | 1.61      | 0.19  | 4000  | 22.37      | 10.06            | 2.57         |

REV. X1  
GALI-33+  
080127

Page 5 of 11



IF/RF MICROWAVE COMPONENTS • ISO 9001 ISO 14001 AS 9100 CERTIFIED • RoHS compliant

P.O. Box 350166, Brooklyn, New York 11235-0003 (718) 934-4500 Fax (718) 332-4661



The Design Engineers Search Engine finds the model you need, Instantly • For detailed performance specs & shopping online see



## Typical Performance Data

### Definitions:

Input Return Loss = -S11 (dB)

Gain(Power Gain) = S21 (dB)

Reverse Isolation = -S12 (dB)

Output Return Loss = -S22 (dB)

TEST CONDITIONS: INPUT POWER = -25dBm, Icc = 48mA, Vd = 4.52V @Temperature = -45degC

| FREQ  | Gain  | Isolation | Input Return Loss | Output Return Loss | Stability |       | FREQ  | IP3 Output | 1dB Comp. Output | Noise Figure |
|-------|-------|-----------|-------------------|--------------------|-----------|-------|-------|------------|------------------|--------------|
| (MHz) | (dB)  | (dB)      | (dB)              | (dB)               | K         | Delta | (MHz) | (dBm)      | (dBm)            | (dB)         |
| 50    | 20.07 | 22.19     | 29.93             | 29.04              | 1.03      | 0.78  | 50    | 32.03      | 16.55            | 2.77         |
| 100   | 20.02 | 21.92     | 32.01             | 33.74              | 1.02      | 0.80  | 100   | 31.89      | 16.19            | 2.86         |
| 150   | 20.03 | 22.25     | 35.78             | 32.66              | 1.03      | 0.77  | 200   | 33.45      | 16.39            | 2.62         |
| 200   | 20.01 | 22.09     | 28.84             | 32.16              | 1.03      | 0.79  | 300   | 33.11      | 16.35            | 2.68         |
| 300   | 19.94 | 22.10     | 26.71             | 32.86              | 1.03      | 0.78  | 400   | 33.12      | 16.37            | 2.57         |
| 400   | 19.94 | 22.16     | 25.64             | 32.06              | 1.03      | 0.78  | 500   | 33.05      | 16.36            | 2.68         |
| 500   | 19.87 | 22.13     | 23.93             | 30.61              | 1.03      | 0.77  | 600   | 33.13      | 16.21            | 2.61         |
| 600   | 19.88 | 22.16     | 21.91             | 30.28              | 1.03      | 0.77  | 700   | 33.76      | 16.12            | 2.75         |
| 700   | 19.76 | 22.25     | 21.43             | 29.19              | 1.04      | 0.75  | 800   | 34.70      | 15.89            | 2.62         |
| 800   | 19.73 | 22.20     | 20.24             | 27.98              | 1.04      | 0.76  | 900   | 34.45      | 15.74            | 2.67         |
| 1000  | 19.58 | 22.36     | 18.55             | 26.47              | 1.05      | 0.73  | 1000  | 33.42      | 15.70            | 2.54         |
| 1200  | 19.44 | 22.40     | 17.36             | 24.26              | 1.05      | 0.72  | 1100  | 34.31      | 15.83            | 2.62         |
| 1400  | 19.26 | 22.51     | 16.29             | 22.61              | 1.06      | 0.70  | 1200  | 34.18      | 15.80            | 2.58         |
| 1600  | 19.11 | 22.66     | 15.57             | 21.22              | 1.07      | 0.68  | 1300  | 34.17      | 15.69            | 2.63         |
| 1800  | 18.96 | 22.74     | 14.71             | 19.72              | 1.08      | 0.67  | 1400  | 33.36      | 15.74            | 2.61         |
| 2000  | 18.76 | 22.91     | 13.94             | 18.66              | 1.10      | 0.64  | 1500  | 33.18      | 15.49            | 2.63         |
| 2200  | 18.56 | 22.98     | 13.47             | 17.92              | 1.11      | 0.63  | 1600  | 33.45      | 15.57            | 2.67         |
| 2400  | 18.42 | 23.08     | 13.14             | 17.16              | 1.12      | 0.61  | 1700  | 34.44      | 15.26            | 2.51         |
| 2600  | 18.19 | 23.27     | 12.23             | 16.38              | 1.14      | 0.59  | 1800  | 34.16      | 15.52            | 2.60         |
| 2800  | 18.03 | 23.28     | 12.14             | 16.02              | 1.15      | 0.58  | 1900  | 33.17      | 15.48            | 2.57         |
| 3000  | 17.88 | 23.58     | 11.69             | 15.69              | 1.17      | 0.56  | 2000  | 32.60      | 15.30            | 2.64         |
| 3200  | 17.65 | 23.83     | 11.34             | 15.70              | 1.20      | 0.53  | 2100  | 32.06      | 15.11            | 2.58         |
| 3400  | 17.62 | 24.10     | 10.95             | 15.28              | 1.22      | 0.52  | 2200  | 31.45      | 14.82            | 2.55         |
| 3600  | 17.51 | 24.13     | 10.62             | 14.95              | 1.22      | 0.51  | 2300  | 31.26      | 14.68            | 2.54         |
| 3800  | 17.38 | 24.40     | 10.39             | 14.89              | 1.25      | 0.49  | 2400  | 30.72      | 14.57            | 2.59         |
| 4000  | 17.31 | 24.33     | 10.54             | 15.00              | 1.25      | 0.48  | 2500  | 30.08      | 14.59            | 2.57         |
| 4200  | 17.25 | 24.69     | 10.10             | 15.07              | 1.28      | 0.46  | 2600  | 29.66      | 14.43            | 2.67         |
| 4400  | 17.25 | 24.90     | 10.17             | 14.34              | 1.29      | 0.45  | 2700  | 29.16      | 14.39            | 2.57         |
| 4600  | 17.14 | 24.93     | 10.27             | 14.41              | 1.31      | 0.44  | 2800  | 28.81      | 14.33            | 2.68         |
| 5000  | 17.16 | 25.22     | 10.24             | 13.40              | 1.32      | 0.43  | 2900  | 28.31      | 14.15            | 2.57         |
| 5500  | 17.12 | 25.09     | 11.45             | 11.24              | 1.29      | 0.42  | 3000  | 27.91      | 13.95            | 2.68         |
| 6000  | 17.30 | 25.04     | 12.31             | 9.56               | 1.23      | 0.43  | 3100  | 27.44      | 13.29            | 2.58         |
| 6500  | 17.82 | 25.03     | 13.61             | 7.72               | 1.13      | 0.45  | 3200  | 26.92      | 13.64            | 2.67         |
| 7000  | 17.85 | 24.94     | 19.64             | 5.60               | 1.02      | 0.44  | 3300  | 26.39      | 13.52            | 2.72         |
| 7500  | 17.39 | 24.47     | 35.02             | 4.37               | 0.95      | 0.45  | 3400  | 25.90      | 13.43            | 2.73         |
| 8000  | 15.83 | 24.49     | 19.01             | 4.18               | 1.02      | 0.39  | 3500  | 25.69      | 13.11            | 2.65         |
| 8500  | 13.54 | 23.19     | 15.76             | 5.06               | 1.18      | 0.34  | 3600  | 25.41      | 12.87            | 2.72         |
| 9000  | 11.50 | 24.07     | 14.11             | 5.55               | 1.61      | 0.28  | 3700  | 25.11      | 13.14            | 2.57         |
| 9500  | 9.63  | 22.27     | 11.81             | 5.44               | 1.50      | 0.23  | 3800  | 24.92      | 12.74            | 2.62         |
| 10000 | 7.82  | 20.94     | 10.34             | 5.79               | 1.55      | 0.20  | 4000  | 24.27      | 12.41            | 2.62         |

## Typical Performance Data

### Definitions:

Input Return Loss = -S11 (dB)

Gain(Power Gain) = S21 (dB)

Reverse Isolation = -S12 (dB)

Output Return Loss = -S22 (dB)

TEST CONDITIONS: INPUT POWER = -25dBm, Icc = 40mA, Vd = 4.07V @Temperature = +85degC

| FREQ  | Gain  | Isolation | Input Return Loss | Output Return Loss | Stability |       | FREQ  | IP3 Output | 1dB Comp. Output | Noise Figure |
|-------|-------|-----------|-------------------|--------------------|-----------|-------|-------|------------|------------------|--------------|
| (MHz) | (dB)  | (dB)      | (dB)              | (dB)               | K         | Delta | (MHz) | (dBm)      | (dBm)            | (dB)         |
| 50    | 19.75 | 21.99     | 29.01             | 24.71              | 1.03      | 0.77  | 50    | 28.09      | 14.57            | 3.46         |
| 100   | 19.71 | 22.08     | 37.55             | 26.13              | 1.04      | 0.76  | 100   | 27.79      | 14.23            | 3.63         |
| 150   | 19.75 | 22.41     | 30.17             | 25.85              | 1.05      | 0.74  | 200   | 28.60      | 14.53            | 3.44         |
| 200   | 19.70 | 21.70     | 28.57             | 25.90              | 1.02      | 0.80  | 300   | 28.03      | 14.42            | 3.57         |
| 300   | 19.62 | 21.97     | 27.06             | 25.54              | 1.04      | 0.76  | 400   | 27.85      | 14.48            | 3.47         |
| 400   | 19.60 | 21.92     | 25.48             | 25.21              | 1.03      | 0.77  | 500   | 27.42      | 14.46            | 3.59         |
| 500   | 19.55 | 22.04     | 23.96             | 24.90              | 1.04      | 0.75  | 600   | 27.32      | 14.35            | 3.54         |
| 600   | 19.53 | 21.99     | 21.82             | 24.76              | 1.04      | 0.76  | 700   | 27.52      | 14.19            | 3.68         |
| 700   | 19.42 | 22.16     | 21.37             | 24.30              | 1.05      | 0.73  | 800   | 28.00      | 13.88            | 3.55         |
| 800   | 19.39 | 22.29     | 20.04             | 23.98              | 1.05      | 0.72  | 900   | 27.83      | 13.85            | 3.61         |
| 1000  | 19.25 | 22.19     | 18.48             | 23.36              | 1.05      | 0.72  | 1000  | 27.24      | 13.74            | 3.49         |
| 1200  | 19.11 | 22.28     | 17.35             | 22.06              | 1.06      | 0.70  | 1100  | 27.58      | 13.86            | 3.56         |
| 1400  | 18.95 | 22.42     | 16.24             | 20.84              | 1.07      | 0.68  | 1200  | 27.60      | 13.69            | 3.54         |
| 1600  | 18.76 | 22.51     | 15.26             | 19.75              | 1.08      | 0.67  | 1300  | 27.26      | 13.63            | 3.56         |
| 1800  | 18.60 | 22.70     | 14.55             | 18.55              | 1.10      | 0.65  | 1400  | 26.99      | 13.69            | 3.60         |
| 2000  | 18.45 | 22.88     | 13.78             | 17.64              | 1.11      | 0.63  | 1500  | 26.78      | 13.48            | 3.60         |
| 2200  | 18.23 | 22.97     | 13.13             | 16.67              | 1.12      | 0.61  | 1600  | 27.13      | 13.57            | 3.64         |
| 2400  | 18.07 | 23.16     | 12.59             | 15.85              | 1.14      | 0.59  | 1700  | 27.53      | 13.24            | 3.52         |
| 2600  | 17.87 | 23.38     | 11.87             | 15.32              | 1.16      | 0.57  | 1800  | 27.24      | 13.51            | 3.56         |
| 2800  | 17.67 | 23.53     | 11.69             | 14.79              | 1.18      | 0.55  | 1900  | 26.62      | 13.34            | 3.59         |
| 3000  | 17.57 | 23.65     | 11.27             | 14.38              | 1.19      | 0.54  | 2000  | 26.31      | 13.26            | 3.60         |
| 3200  | 17.31 | 24.00     | 10.86             | 14.42              | 1.23      | 0.51  | 2100  | 26.01      | 13.05            | 3.57         |
| 3400  | 17.27 | 23.86     | 10.58             | 14.06              | 1.22      | 0.52  | 2200  | 25.69      | 12.66            | 3.54         |
| 3600  | 17.17 | 24.17     | 10.26             | 13.76              | 1.24      | 0.50  | 2300  | 25.53      | 12.57            | 3.52         |
| 3800  | 17.04 | 24.31     | 10.12             | 13.64              | 1.26      | 0.48  | 2400  | 25.17      | 12.44            | 3.60         |
| 4000  | 16.97 | 24.32     | 10.00             | 13.74              | 1.26      | 0.47  | 2500  | 24.67      | 12.61            | 3.58         |
| 4200  | 16.90 | 24.54     | 9.90              | 13.87              | 1.28      | 0.46  | 2600  | 24.46      | 12.30            | 3.67         |
| 4400  | 16.87 | 24.57     | 10.01             | 13.62              | 1.29      | 0.45  | 2700  | 24.03      | 12.21            | 3.58         |
| 4600  | 16.84 | 24.85     | 10.10             | 13.70              | 1.31      | 0.43  | 2800  | 23.76      | 12.20            | 3.65         |
| 5000  | 16.81 | 24.84     | 10.89             | 12.81              | 1.31      | 0.41  | 2900  | 23.39      | 12.03            | 3.61         |
| 5500  | 16.74 | 24.64     | 12.86             | 10.80              | 1.27      | 0.40  | 3000  | 23.17      | 11.89            | 3.64         |
| 6000  | 16.69 | 24.36     | 15.71             | 9.08               | 1.21      | 0.39  | 3100  | 22.83      | 11.19            | 3.63         |
| 6500  | 16.56 | 24.25     | 18.52             | 7.64               | 1.15      | 0.37  | 3200  | 22.54      | 11.65            | 3.72         |
| 7000  | 16.28 | 23.67     | 21.15             | 6.72               | 1.10      | 0.40  | 3300  | 22.26      | 11.39            | 3.70         |
| 7500  | 14.65 | 23.85     | 15.53             | 6.51               | 1.23      | 0.32  | 3400  | 21.94      | 11.34            | 3.79         |
| 8000  | 12.59 | 24.37     | 12.85             | 6.20               | 1.52      | 0.28  | 3500  | 21.93      | 10.93            | 3.69         |
| 8500  | 10.35 | 24.32     | 10.79             | 5.87               | 1.78      | 0.24  | 3600  | 21.80      | 10.56            | 3.78         |
| 9000  | 8.14  | 23.44     | 9.94              | 6.12               | 2.03      | 0.21  | 3700  | 21.60      | 10.57            | 3.65         |
| 9500  | 6.30  | 22.95     | 9.09              | 6.17               | 2.26      | 0.17  | 3800  | 21.52      | 10.02            | 3.67         |
| 10000 | 4.79  | 21.91     | 8.48              | 5.99               | 2.26      | 0.15  | 4000  | 20.90      | 9.61             | 3.66         |

## Typical Performance Data

### Definitions:

Input Return Loss = -S11 (dB)

Gain(Power Gain) = S21 (dB)

Reverse Isolation = -S12 (dB)

Output Return Loss = -S22 (dB)

TEST CONDITIONS: INPUT POWER = -25dBm, Icc = 32mA, Vd = 4.02V @Temperature = +85degC

| FREQ  | Gain  | Isolation | Input Return Loss | Output Return Loss | Stability |       | FREQ  | IP3 Output | 1dB Comp. Output | Noise Figure |
|-------|-------|-----------|-------------------|--------------------|-----------|-------|-------|------------|------------------|--------------|
| (MHz) | (dB)  | (dB)      | (dB)              | (dB)               | K         | Delta | (MHz) | (dBm)      | (dBm)            | (dB)         |
| 50    | 19.34 | 21.89     | 25.22             | 19.29              | 1.04      | 0.75  | 50    | 24.64      | 11.87            | 3.45         |
| 100   | 19.31 | 21.84     | 27.89             | 21.38              | 1.04      | 0.75  | 100   | 24.38      | 11.39            | 3.56         |
| 150   | 19.31 | 21.63     | 24.15             | 21.12              | 1.03      | 0.77  | 200   | 24.95      | 11.64            | 3.46         |
| 200   | 19.30 | 21.72     | 25.23             | 21.20              | 1.04      | 0.76  | 300   | 24.48      | 11.61            | 3.50         |
| 300   | 19.19 | 21.90     | 24.33             | 21.33              | 1.05      | 0.74  | 400   | 24.37      | 11.59            | 3.49         |
| 400   | 19.19 | 21.84     | 22.97             | 21.05              | 1.04      | 0.74  | 500   | 24.00      | 11.68            | 3.55         |
| 500   | 19.12 | 21.64     | 22.48             | 20.88              | 1.04      | 0.75  | 600   | 23.94      | 11.42            | 3.52         |
| 600   | 19.11 | 21.78     | 20.72             | 21.01              | 1.04      | 0.74  | 700   | 24.12      | 11.44            | 3.64         |
| 700   | 19.00 | 21.92     | 20.61             | 20.84              | 1.05      | 0.72  | 800   | 24.58      | 10.99            | 3.53         |
| 800   | 19.00 | 21.79     | 19.38             | 20.34              | 1.05      | 0.73  | 900   | 24.38      | 11.10            | 3.56         |
| 1000  | 18.90 | 21.83     | 18.12             | 20.38              | 1.05      | 0.72  | 1000  | 23.91      | 10.95            | 3.46         |
| 1200  | 18.76 | 22.03     | 17.07             | 19.53              | 1.06      | 0.70  | 1100  | 24.23      | 11.19            | 3.52         |
| 1400  | 18.58 | 22.22     | 16.02             | 18.69              | 1.08      | 0.68  | 1200  | 24.28      | 11.04            | 3.53         |
| 1600  | 18.42 | 22.23     | 15.02             | 17.68              | 1.08      | 0.67  | 1300  | 24.04      | 10.95            | 3.54         |
| 1800  | 18.29 | 22.43     | 14.32             | 16.71              | 1.10      | 0.65  | 1400  | 23.85      | 11.06            | 3.56         |
| 2000  | 18.11 | 22.54     | 13.56             | 15.99              | 1.11      | 0.63  | 1500  | 23.83      | 10.71            | 3.57         |
| 2200  | 17.93 | 22.58     | 13.00             | 15.25              | 1.12      | 0.62  | 1600  | 24.14      | 10.93            | 3.59         |
| 2400  | 17.78 | 22.78     | 12.36             | 14.59              | 1.13      | 0.60  | 1700  | 24.51      | 10.62            | 3.50         |
| 2600  | 17.57 | 23.26     | 11.65             | 14.12              | 1.17      | 0.57  | 1800  | 24.31      | 10.99            | 3.50         |
| 2800  | 17.40 | 23.20     | 11.42             | 13.55              | 1.17      | 0.56  | 1900  | 23.92      | 10.88            | 3.57         |
| 3000  | 17.26 | 23.52     | 10.98             | 13.23              | 1.20      | 0.54  | 2000  | 23.69      | 10.81            | 3.56         |
| 3200  | 17.07 | 23.62     | 10.62             | 13.21              | 1.21      | 0.53  | 2100  | 23.49      | 10.58            | 3.54         |
| 3400  | 17.02 | 23.68     | 10.29             | 12.91              | 1.21      | 0.52  | 2200  | 23.24      | 10.05            | 3.49         |
| 3600  | 16.94 | 23.95     | 10.00             | 12.55              | 1.23      | 0.50  | 2300  | 23.20      | 10.16            | 3.51         |
| 3800  | 16.80 | 24.03     | 9.88              | 12.45              | 1.24      | 0.49  | 2400  | 22.94      | 10.00            | 3.55         |
| 4000  | 16.74 | 24.14     | 9.76              | 12.68              | 1.25      | 0.48  | 2500  | 22.61      | 10.31            | 3.56         |
| 4200  | 16.68 | 24.29     | 9.65              | 12.75              | 1.27      | 0.46  | 2600  | 22.60      | 10.08            | 3.61         |
| 4400  | 16.66 | 24.35     | 9.68              | 12.60              | 1.26      | 0.45  | 2700  | 22.32      | 10.16            | 3.54         |
| 4600  | 16.64 | 24.62     | 9.81              | 12.57              | 1.29      | 0.44  | 2800  | 22.16      | 10.24            | 3.62         |
| 5000  | 16.64 | 24.49     | 10.59             | 11.84              | 1.27      | 0.42  | 2900  | 21.83      | 10.16            | 3.55         |
| 5500  | 16.58 | 24.43     | 12.55             | 10.15              | 1.25      | 0.40  | 3000  | 21.68      | 10.08            | 3.55         |
| 6000  | 16.51 | 23.95     | 15.12             | 8.54               | 1.16      | 0.40  | 3100  | 21.36      | 9.48             | 3.61         |
| 6500  | 16.40 | 23.78     | 17.32             | 7.18               | 1.09      | 0.37  | 3200  | 21.14      | 10.04            | 3.68         |
| 7000  | 16.07 | 23.36     | 19.26             | 6.40               | 1.05      | 0.39  | 3300  | 20.93      | 10.00            | 3.67         |
| 7500  | 14.41 | 23.46     | 14.84             | 6.27               | 1.18      | 0.32  | 3400  | 20.66      | 10.05            | 3.74         |
| 8000  | 12.37 | 23.97     | 12.53             | 6.03               | 1.46      | 0.27  | 3500  | 20.66      | 9.63             | 3.66         |
| 8500  | 10.13 | 23.96     | 10.61             | 5.73               | 1.72      | 0.23  | 3600  | 20.54      | 9.42             | 3.74         |
| 9000  | 7.91  | 23.23     | 9.82              | 5.98               | 2.00      | 0.20  | 3700  | 20.33      | 9.45             | 3.59         |
| 9500  | 6.09  | 22.79     | 9.00              | 6.05               | 2.24      | 0.17  | 3800  | 20.23      | 8.97             | 3.64         |
| 10000 | 4.55  | 21.76     | 8.36              | 5.90               | 2.25      | 0.15  | 4000  | 19.64      | 8.70             | 3.63         |

## Typical Performance Data

### Definitions:

Input Return Loss = -S11 (dB)

Gain(Power Gain) = S21 (dB)

Reverse Isolation = -S12 (dB)

Output Return Loss = -S22 (dB)

TEST CONDITIONS: INPUT POWER = -25dBm, Icc = 48mA, Vd = 4.11V @Temperature = +85degC

| FREQ  | Gain  | Isolation | Input Return Loss | Output Return Loss | Stability |       | FREQ  | IP3 Output | 1dB Comp. Output | Noise Figure |
|-------|-------|-----------|-------------------|--------------------|-----------|-------|-------|------------|------------------|--------------|
| (MHz) | (dB)  | (dB)      | (dB)              | (dB)               | K         | Delta | (MHz) | (dBm)      | (dBm)            | (dB)         |
| 50    | 19.99 | 22.61     | 30.00             | 29.06              | 1.04      | 0.74  | 50    | 30.88      | 16.64            | 3.48         |
| 100   | 19.97 | 22.16     | 33.33             | 31.62              | 1.03      | 0.78  | 100   | 30.70      | 16.35            | 3.67         |
| 150   | 19.99 | 22.38     | 34.75             | 29.70              | 1.04      | 0.76  | 200   | 31.62      | 16.52            | 3.48         |
| 200   | 19.97 | 22.24     | 28.66             | 30.83              | 1.03      | 0.77  | 300   | 31.01      | 16.44            | 3.60         |
| 300   | 19.87 | 22.25     | 27.15             | 30.84              | 1.04      | 0.76  | 400   | 30.72      | 16.45            | 3.48         |
| 400   | 19.87 | 22.41     | 25.74             | 29.41              | 1.04      | 0.75  | 500   | 30.23      | 16.42            | 3.64         |
| 500   | 19.79 | 22.25     | 24.22             | 28.71              | 1.04      | 0.75  | 600   | 30.10      | 16.30            | 3.53         |
| 600   | 19.78 | 22.22     | 21.91             | 28.29              | 1.04      | 0.76  | 700   | 30.27      | 16.17            | 3.73         |
| 700   | 19.66 | 22.30     | 21.49             | 27.53              | 1.04      | 0.74  | 800   | 30.81      | 15.95            | 3.57         |
| 800   | 19.62 | 22.31     | 20.11             | 26.53              | 1.04      | 0.74  | 900   | 30.60      | 15.90            | 3.62         |
| 1000  | 19.48 | 22.42     | 18.45             | 25.51              | 1.05      | 0.72  | 1000  | 29.80      | 15.80            | 3.48         |
| 1200  | 19.32 | 22.42     | 17.41             | 23.80              | 1.06      | 0.71  | 1100  | 30.27      | 15.79            | 3.58         |
| 1400  | 19.18 | 22.67     | 16.28             | 22.23              | 1.07      | 0.68  | 1200  | 30.18      | 15.70            | 3.58         |
| 1600  | 18.97 | 22.69     | 15.31             | 20.84              | 1.08      | 0.67  | 1300  | 29.75      | 15.56            | 3.60         |
| 1800  | 18.83 | 22.79     | 14.63             | 19.58              | 1.09      | 0.65  | 1400  | 29.26      | 15.58            | 3.60         |
| 2000  | 18.63 | 22.93     | 13.93             | 18.56              | 1.10      | 0.63  | 1500  | 29.00      | 15.30            | 3.59         |
| 2200  | 18.42 | 23.20     | 13.34             | 17.63              | 1.13      | 0.60  | 1600  | 29.34      | 15.35            | 3.66         |
| 2400  | 18.26 | 23.28     | 12.84             | 16.71              | 1.14      | 0.59  | 1700  | 29.83      | 15.01            | 3.52         |
| 2600  | 18.04 | 23.43     | 12.06             | 16.14              | 1.16      | 0.57  | 1800  | 29.31      | 15.18            | 3.59         |
| 2800  | 17.85 | 23.60     | 11.87             | 15.52              | 1.18      | 0.55  | 1900  | 28.57      | 15.02            | 3.59         |
| 3000  | 17.75 | 23.78     | 11.44             | 15.16              | 1.19      | 0.54  | 2000  | 28.17      | 14.91            | 3.64         |
| 3200  | 17.49 | 23.94     | 11.04             | 15.14              | 1.22      | 0.52  | 2100  | 27.74      | 14.72            | 3.60         |
| 3400  | 17.45 | 24.01     | 10.74             | 14.78              | 1.22      | 0.51  | 2200  | 27.34      | 14.45            | 3.59         |
| 3600  | 17.33 | 24.38     | 10.46             | 14.43              | 1.25      | 0.49  | 2300  | 27.12      | 14.21            | 3.54         |
| 3800  | 17.20 | 24.37     | 10.29             | 14.32              | 1.26      | 0.48  | 2400  | 26.62      | 13.88            | 3.65         |
| 4000  | 17.12 | 24.40     | 10.21             | 14.39              | 1.26      | 0.47  | 2500  | 26.12      | 13.98            | 3.59         |
| 4200  | 17.07 | 24.73     | 10.11             | 14.57              | 1.29      | 0.45  | 2600  | 25.71      | 13.53            | 3.71         |
| 4400  | 17.01 | 24.73     | 10.18             | 14.32              | 1.30      | 0.45  | 2700  | 25.22      | 13.31            | 3.61         |
| 4600  | 16.99 | 24.84     | 10.24             | 14.30              | 1.30      | 0.43  | 2800  | 24.86      | 13.23            | 3.70         |
| 5000  | 16.94 | 25.21     | 11.01             | 13.35              | 1.34      | 0.40  | 2900  | 24.50      | 13.02            | 3.63         |
| 5500  | 16.88 | 24.97     | 13.08             | 11.23              | 1.31      | 0.40  | 3000  | 24.23      | 12.81            | 3.66         |
| 6000  | 16.84 | 24.71     | 16.01             | 9.36               | 1.25      | 0.39  | 3100  | 23.90      | 12.06            | 3.65         |
| 6500  | 16.75 | 24.50     | 19.48             | 7.79               | 1.17      | 0.37  | 3200  | 23.57      | 12.41            | 3.73         |
| 7000  | 16.52 | 23.82     | 22.98             | 6.85               | 1.11      | 0.41  | 3300  | 23.27      | 12.18            | 3.75         |
| 7500  | 14.87 | 24.18     | 16.19             | 6.61               | 1.26      | 0.32  | 3400  | 22.97      | 12.07            | 3.79         |
| 8000  | 12.81 | 24.56     | 13.08             | 6.20               | 1.53      | 0.28  | 3500  | 22.96      | 11.64            | 3.72         |
| 8500  | 10.58 | 24.58     | 10.88             | 5.89               | 1.80      | 0.24  | 3600  | 22.84      | 11.34            | 3.81         |
| 9000  | 8.36  | 23.62     | 10.01             | 6.09               | 2.02      | 0.21  | 3700  | 22.66      | 11.32            | 3.68         |
| 9500  | 6.51  | 23.09     | 9.21              | 6.18               | 2.26      | 0.18  | 3800  | 22.66      | 10.70            | 3.69         |
| 10000 | 5.00  | 21.98     | 8.58              | 6.05               | 2.25      | 0.16  | 4000  | 21.99      | 10.14            | 3.67         |

## Typical Performance Curves

**GAIN vs. TEMPERATURE**

INPUT POWER = -25dBm, CURRENT = 40mA

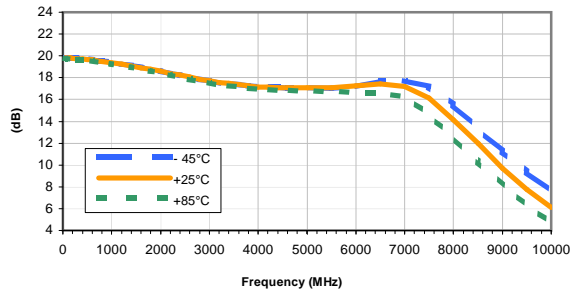

**GAIN vs. CURRENT**

INPUT POWER = -25dBm, Temperature = +25°C

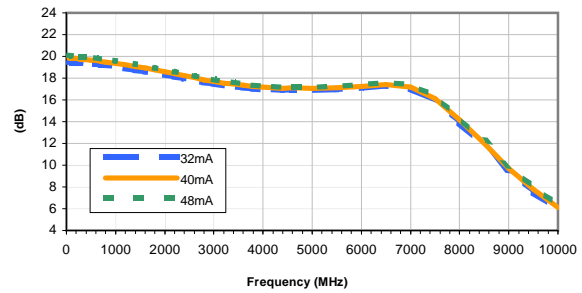

**ISOLATION vs. TEMPERATURE**

INPUT POWER = -25dBm, CURRENT = 40mA

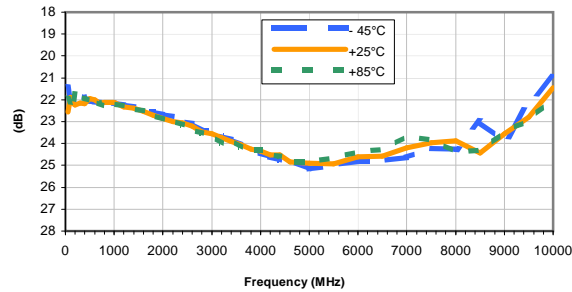

**ISOLATION vs. CURRENT**

INPUT POWER = -25dBm, Temperature = +25°C

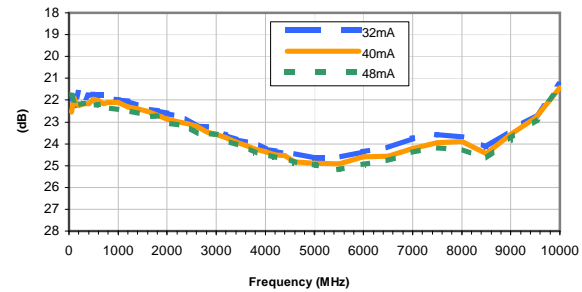

**INPUT RETURN LOSS vs. TEMPERATURE**

INPUT POWER = -25dBm, CURRENT = 40mA

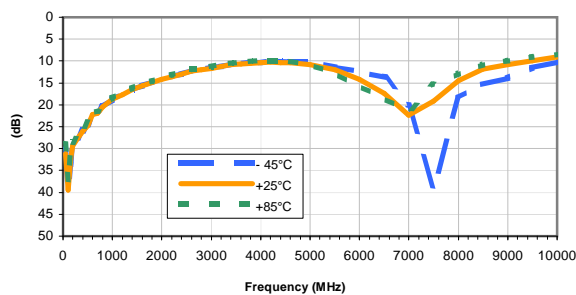

**INPUT RETURN LOSS vs. CURRENT**

INPUT POWER = -25dBm, Temperature = +25°C

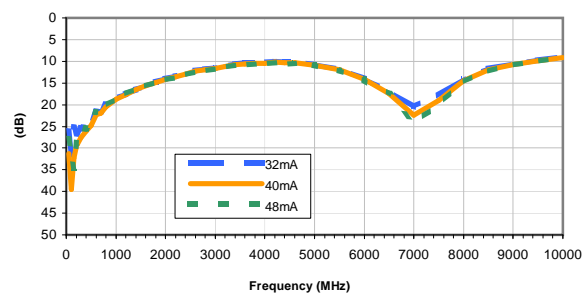

**OUTPUT RETURN LOSS vs. TEMPERATURE**

INPUT POWER = -25dBm, CURRENT = 40mA

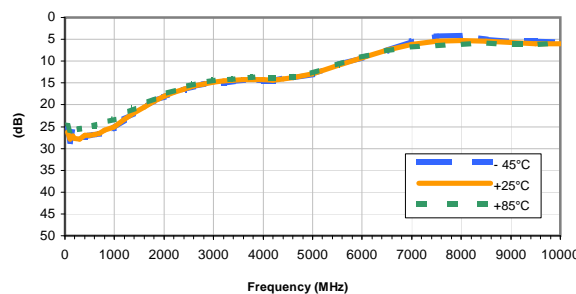

**OUTPUT RETURN LOSS vs. CURRENT**

INPUT POWER = -25dBm, Temperature = +25°C

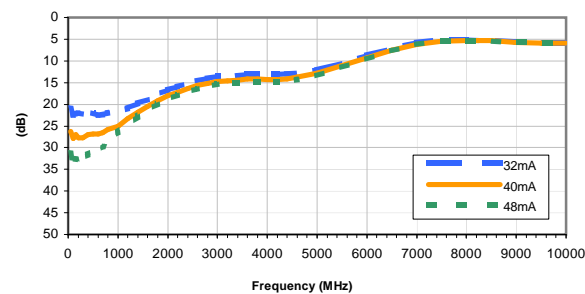

IF/RF MICROWAVE COMPONENTS • ISO 9001 ISO 14001 AS 9100 CERTIFIED • RoHS compliant  
P.O. Box 350166, Brooklyn, New York 11235-0003 (718) 934-4500 Fax (718) 332-4661



The Design Engineers Search Engine finds the model you need, Instantly • For detailed performance specs & shopping online see



## Typical Performance Curves

**OUTPUT IP3 vs. TEMPERATURE**

INPUT POWER = -25dBm, CURRENT = 40mA

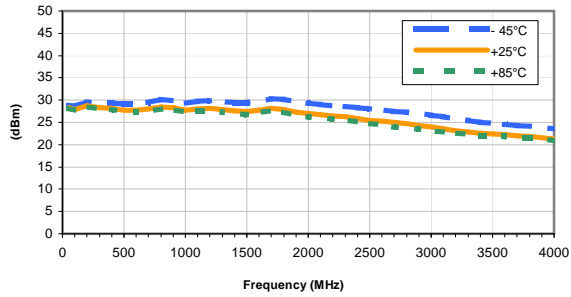

**OUTPUT IP3 vs. CURRENT**

INPUT POWER = -25dBm, Temperature = +25°C

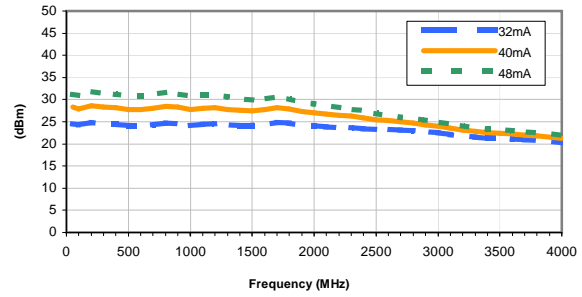

**OUTPUT POWER at 1dB Compression vs. TEMPERATURE**

CURRENT = 40mA

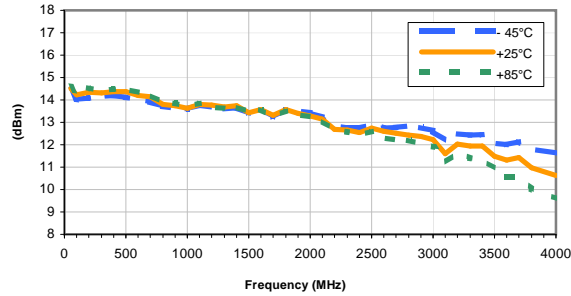

**OUTPUT POWER at 1dB Compression vs. CURRENT**

Temperature = +25°C

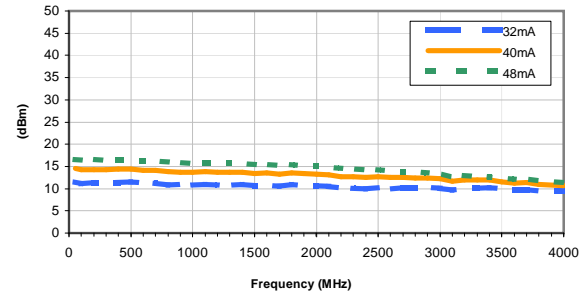

**Noise Figure vs. TEMPERATURE**

CURRENT = 40mA

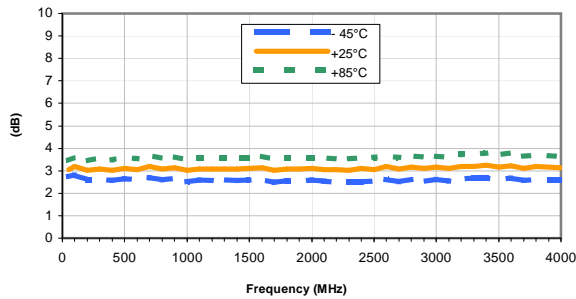

**Noise Figure vs. CURRENT**

Temperature = +25°C

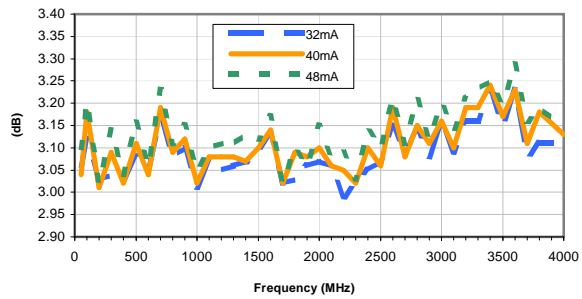

## Typical Performance Curves

### GAIN vs. TEMPERATURE

INPUT POWER = -25dBm, CURRENT = 40mA

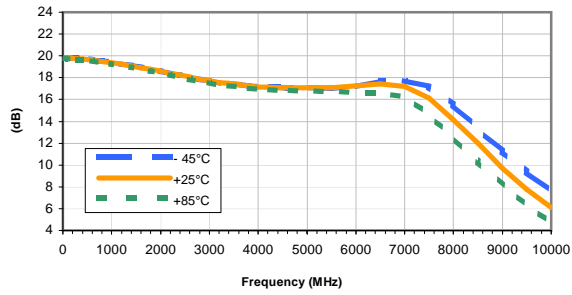

### GAIN vs. CURRENT

INPUT POWER = -25dBm, Temperature = +25°C

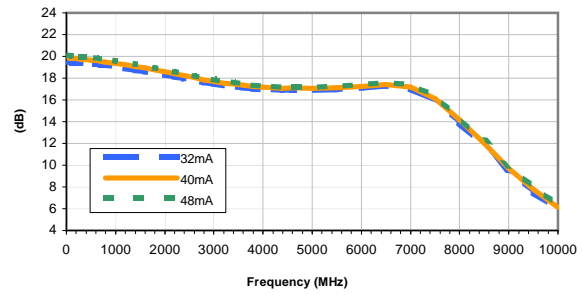

### ISOLATION vs. TEMPERATURE

INPUT POWER = -25dBm, CURRENT = 40mA

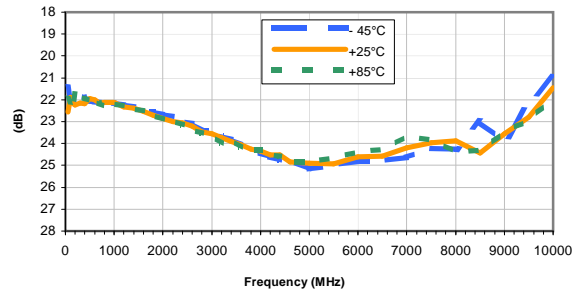

### ISOLATION vs. CURRENT

INPUT POWER = -25dBm, Temperature = +25°C

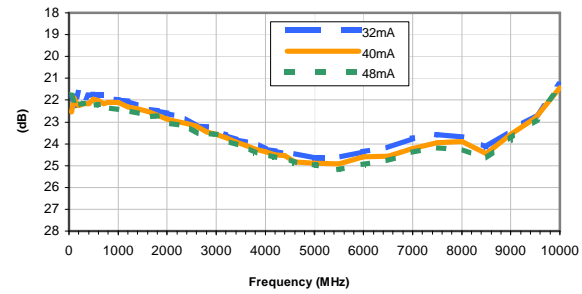

### INPUT RETURN LOSS vs. TEMPERATURE

INPUT POWER = -25dBm, CURRENT = 40mA

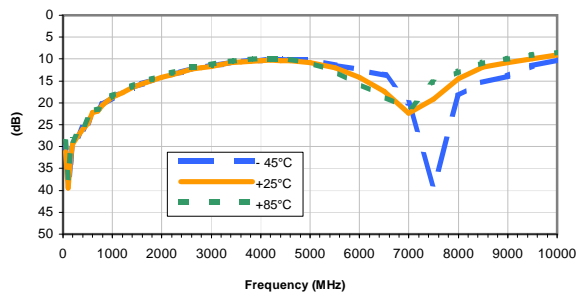

### INPUT RETURN LOSS vs. CURRENT

INPUT POWER = -25dBm, Temperature = +25°C

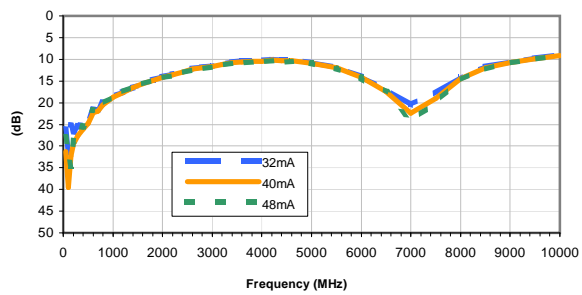

### OUTPUT RETURN LOSS vs. TEMPERATURE

INPUT POWER = -25dBm, CURRENT = 40mA

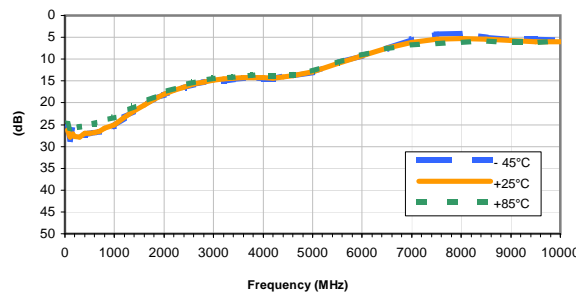

### OUTPUT RETURN LOSS vs. CURRENT

INPUT POWER = -25dBm, Temperature = +25°C

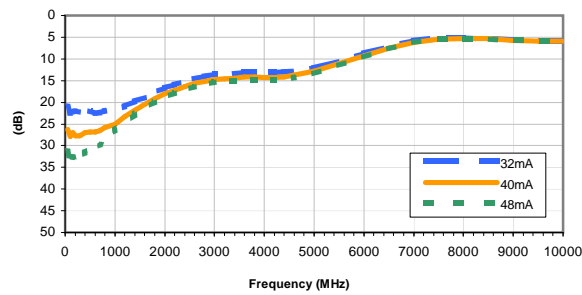



## Typical Performance Curves

**OUTPUT IP3 vs. TEMPERATURE**

INPUT POWER = -25dBm, CURRENT = 40mA

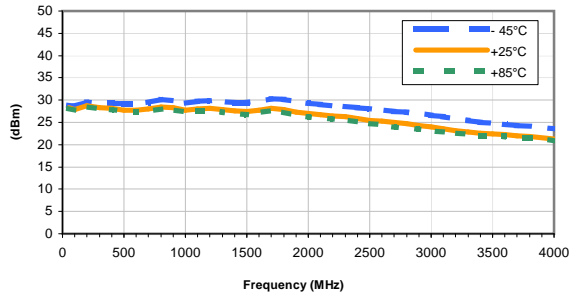

**OUTPUT IP3 vs. CURRENT**

INPUT POWER = -25dBm, Temperature = +25°C

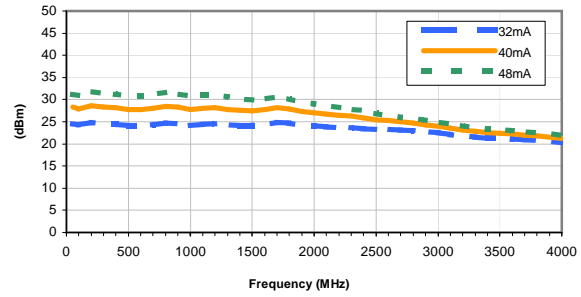

**OUTPUT POWER at 1dB Compression vs. TEMPERATURE**

CURRENT = 40mA

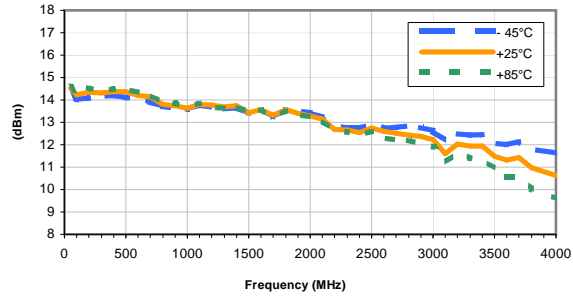

**OUTPUT POWER at 1dB Compression vs. CURRENT**

Temperature = +25°C

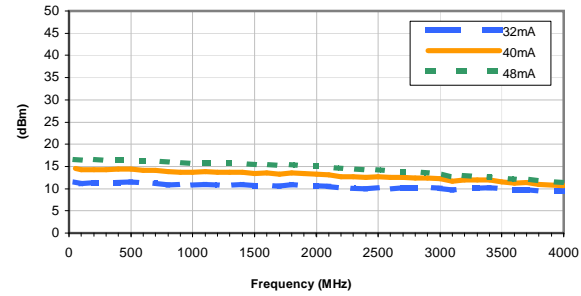

**Noise Figure vs. TEMPERATURE**

CURRENT = 40mA

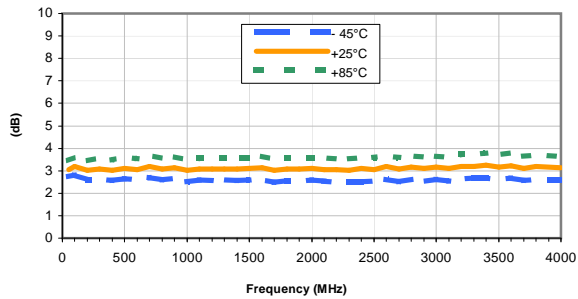

**Noise Figure vs. CURRENT**

Temperature = +25°C

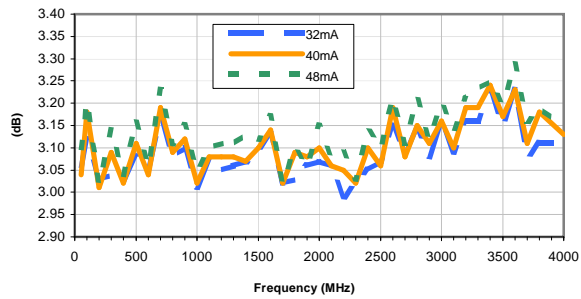

### Outline Dimensions



### PCB Land Pattern

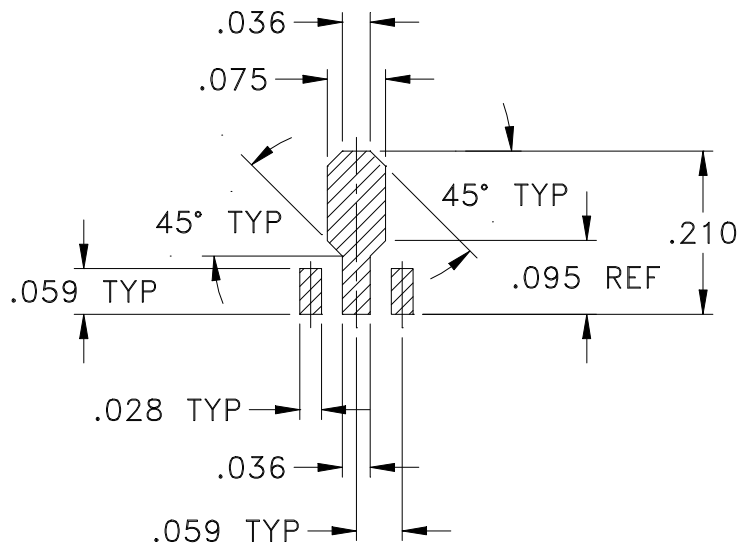

Suggested Layout,  
Tolerance to be within  $\pm .002$

| CASE # | A              | B              | C              | D              | E              | F              | G              | H              | J              | K              | L              | M              |
|--------|----------------|----------------|----------------|----------------|----------------|----------------|----------------|----------------|----------------|----------------|----------------|----------------|
| DF782  | .102<br>(2.59) | .090<br>(2.29) | .181<br>(4.60) | .173<br>(4.39) | .063<br>(1.60) | .167<br>(4.24) | .155<br>(3.94) | .059<br>(1.50) | .118<br>(3.00) | .015<br>(0.38) | .041<br>(1.04) | .016<br>(0.41) |

| CASE # | N              | P              | Q              | WT. GRAM |
|--------|----------------|----------------|----------------|----------|
| DF782  | .019<br>(0.48) | .065<br>(1.65) | .062<br>(1.57) | .2       |

Dimensions are in inches (mm). Tolerances: 2 Pl.  $\pm .01$ ; 3Pl.  $\pm .005$

#### Notes:

- Case material: Plastic.
- Termination finish:  
For RoHS Case Styles: Tin-Silver alloy plate over Nickel barrier or Matte-Tin.  
All models, (+) suffix. See model Data sheet.  
For RoHS-5 Case Styles: Tin-Lead plate. All models, no (+) suffix.



INTERNET <http://www.minicircuits.com>

P.O. Box 350166, Brooklyn, New York 11235-0003 (718) 934-4500 Fax (718) 332-4661

Distribution Centers NORTH AMERICA 800-654-7949 • 417-335-5935 • Fax 417-335-5945 • EUROPE 44-1252-832600 • Fax 44-1252-837010

Mini-Circuits ISO 9001 & ISO 14001 Certified

# Tape & Reel Packaging TR-F55

## DEVICE ORIENTATION IN T&R



| Tape Width, mm | Device Cavity Pitch, mm | Reel Size, inches | Devices per Reel                   |      |
|----------------|-------------------------|-------------------|------------------------------------|------|
| 12             | 8                       | 7                 | Small quantity standard (see note) | 20   |
|                |                         |                   |                                    | 50   |
|                |                         |                   |                                    | 100  |
|                |                         |                   |                                    | 200  |
|                |                         |                   |                                    | 500  |
|                |                         |                   | Standard                           | 1000 |

Note: Please consult individual model data sheet to determine device per reel availability.

Mini-Circuits carrier tape materials provide protection from ESD (Electro-Static Discharge) during handling and transportation. Tapes are static dissipative and comply with industry standards EIA-481/EIA-541.

Go to: [www.minicircuits.com/pages/pdfs/tape.pdf](http://www.minicircuits.com/pages/pdfs/tape.pdf)



INTERNET <http://www.minicircuits.com>

P.O. Box 350166, Brooklyn, New York 11235-0003 (718) 934-4500 Fax (718) 332-4661

Distribution Centers NORTH AMERICA 800-654-7949 • 417-335-5935 • Fax 417-335-5945 • EUROPE 44-1252-832600 • Fax 44-1252-837010

Mini-Circuits ISO 9001 & ISO 14001 Certified

THIRD ANGLE PROJECTION



REVISIONS

| REV | ECN No. | DESCRIPTION                    | DATE     | DR  | AUTH |
|-----|---------|--------------------------------|----------|-----|------|
| A   | M76190  | CHANGED DISCRIPTION            | 04/01    | GF  | CT   |
| B   | M82575  | UPDATED DRAWING                | 08/05/02 | AV  | LC   |
| C   | M102713 | ADDED NOTE 2 & "...WITH SMOBC" | 01/17/06 | MMG | IL   |
| D   | M108434 | UPDATED DRAWING PER TB-409+    | 11/14/06 | PW  | IG   |

SUGGESTED MOUNTING CONFIGURATION  
FOR DF782 CASE STYLE, "mz" PIN CONNECTION



- NOTES:** 1. TRACE WIDTH IS SHOWN FOR ROGERS R04350B WITH DIELECTRIC THICKNESS .030" ± .002"; COPPER: 1/2 OZ. EACH SIDE. FOR OTHER MATERIALS TRACE WIDTH MAY NEED TO BE MODIFIED.  
2. BOTTOM SIDE OF THE PCB IS CONTINUOUS GROUND PLANE.



DENOTES PCB COPPER LAYOUT WITH SMOBC (SOLDER MASK OVER BARE COPPER)



DENOTES COPPER LAND PATTERN FREE OF SOLDER MASK

UNLESS OTHERWISE SPECIFIED

INITIALS

DATE

DIMENSIONS ARE IN INCHES

DRAWN

AV

01/15/01

TOLERANCES ON:

CHECKED

YB

01/23/01

2 PL DECIMALS ± .005

APPROVED

DB

01/23/01

3 PL DECIMALS ±

ANGLES ±

FRACTIONS ±

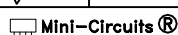

THIS DOCUMENT AND ITS CONTENTS ARE THE PROPERTY OF MINI-CIRCUITS. EXCEPT FOR USE EXPRESSLY GRANTED, IN WRITING, TO ITS VENDORS, VENDEE AND THE UNITED STATES GOVERNMENT, MINI-CIRCUITS RESERVES ALL PROPRIETARY DESIGN, USE, MANUFACTURING AND REPRODUCTION RIGHTS THERETO. THESE CONTENTS SHALL NOT BE USED, DUPLICATED OR DISCLOSED TO ANY OUTSIDE PARTY, IN WHOLE OR IN PART, WITHOUT WRITTEN PERMISSION OF MINI-CIRCUITS.



Mini-Circuits®

13 Neptune Avenue  
Brooklyn NY 11235

PL, mz, DF782, GALI, TB-409-XXX+

SIZE

CODE IDENT

DRAWING NO:

REV:

A

15542

98-PL-019

D

FILE:

98PL019

SCALE:

10:1

SHEET:

1 OF 1

# Evaluation Board and Circuit

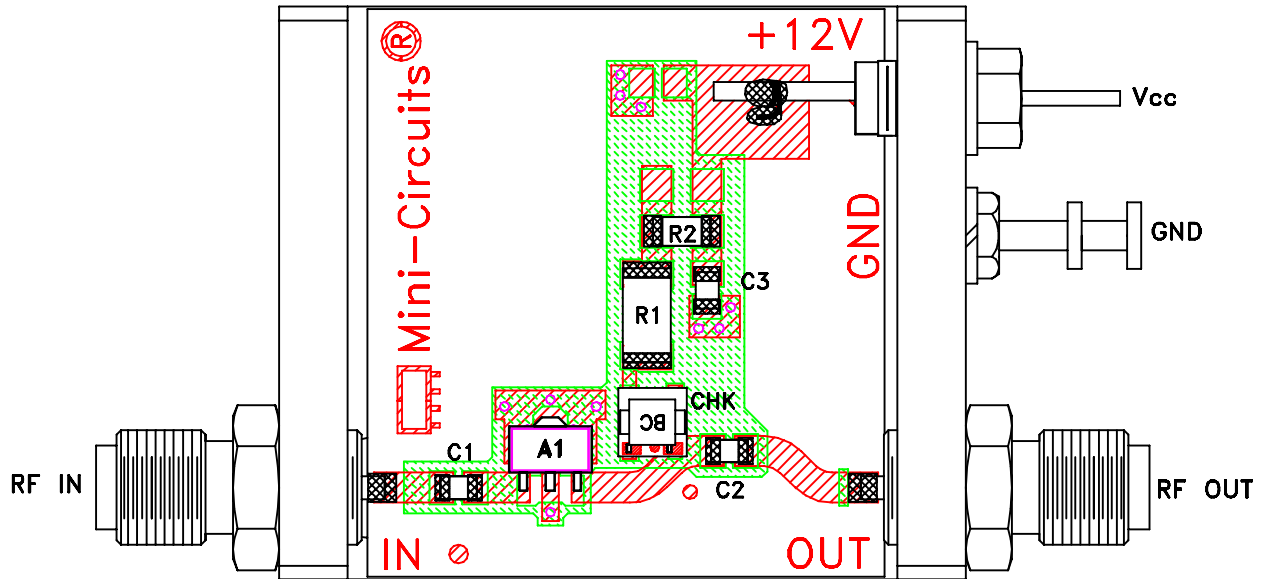

TB-409-33+

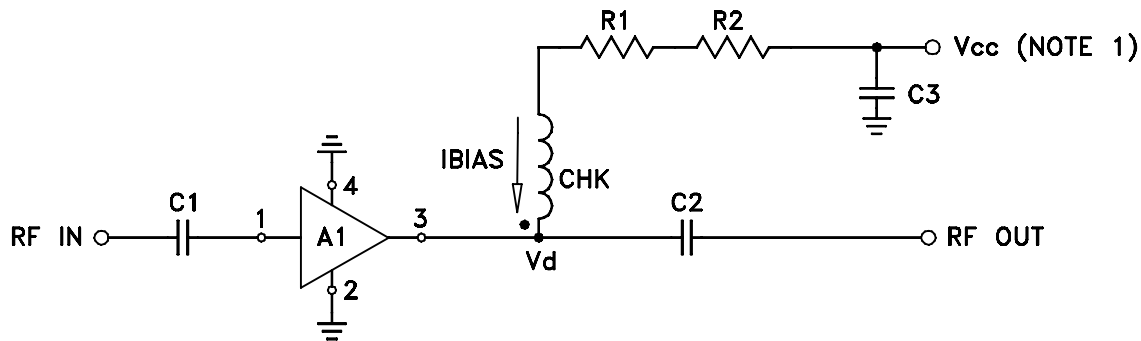

| COMPONENT   | VALUE                  |
|-------------|------------------------|
| A1          | Gali-33(+)             |
| C1 (NOTE 4) | 2400 pF                |
| C2 (NOTE 4) | 2400 pF                |
| C3 (bypass) | 0.1 uF                 |
| R1          | 191 Ohms, 0.75W        |
| R2          | 2.21 Ohms, 0.25W       |
| CHK         | Mini-Circuits TCCH-80+ |

Schematic Diagram

## NOTE:

1. Vcc voltage:  $+12 \pm 0.2V$ .
2. SMA Female connectors.
3. PCB material: Rogers RO4350 or equivalent, dielectric constant=3.5, dielectric thickness=.030 inch.
4. Capacitors, C1 & C2 should be free of resonance up to the highest frequency specified.

 **Mini-Circuits®**

All Mini-Circuits products are manufactured under exacting quality assurance and control standards, and are capable of meeting published specifications after being subjected to any or all of the following physical and environmental test.

| Specification                  | Test/Inspection Condition  | Reference/Spec  |
|--------------------------------|--|---|
| Operating Temperature          | -45° to 85°C or -40° to 85°C<br>Ambient Environment  | Individual Model Data Sheet                                     |
| Storage Temperature            | -65° to 150° C<br>Ambient Environment  | Individual Model Data Sheet                                     |
| Thermal Shock                  | -55° to 100°C, 100 cycles  | MIL-STD-202, Method 107, Condition A-3, except +100°C           |
| Mechanical Shock               | 1.5Kg, 0.5 ms, 5 shock pulses, Y1 direction only   | MIL-STD-883, Method 2002, Condition B, except Y1 direction only |
| Vibration (Variable Frequency) | 50g peak   | MIL-STD-883, Method 2007, Condition B                           |
| Autoclave                      | 15 psig, 100% RH, 121°C, 96 hours  | JESD22-A102, Condition C  |
| HAST                           | 130°C, 85% RH, 96 hours  | JESD22-A110   |
| Solderability                  | 10X Magnification  | J-STD-002, Para 4.2.5, Test S, 95% Coverage                     |
| Solder Reflow Heat             | Sn-Pb Eutetic Process: 240°C peak<br>Pb-Free Process: 260°C peak   | J-STD-020, Table 4-1, 4-2 and 5-2; Figure 5-1                   |
| Moisture Sensitivity: Level 1  | Bake at 125°C for 24 hours<br>Soak at 85°C/85% RH for 168 hours, Reflow 3 cycles at 260°C peak                                 | J-STD-020   |
| Marking Resistance to Solvents | Isopropyl alcohol + mineral spirits at 25°C; terpene defluxer at 25°C;<br>distilled water + proylene glycol monomethyl ether + | MIL-STD-202, Method 215   |



All Mini-Circuits products are manufactured under exacting quality assurance and control standards, and are capable of meeting published specifications after being subjected to any or all of the following physical and environmental test.

| <b>Specification</b> | <b>Test/Inspection Condition</b> | <b>Reference/Spec</b> |
|----------------------|----------------------------------|-----------------------|
|                      | monoethanolamine at 63°C to 70°C |                       |