

Surface Mount

Monolithic Amplifier

DC-4 GHz

Features

- InGaP HBT microwave amplifier
- Miniature SOT-89 package
- Internally Matched to 50 Ohms
- Frequency range, DC to 4 GHz
- Output power, 18.0 dBm typ.,
- Excellent package for heat dissipation, exposed metal bottom
- Low thermal resistance for high reliability
- Aqueous washable
- Protected by US Patent 6,943,629

Applications

- Cellular
- PCS
- Communication receivers & transmitters

General Description

Gali₅₁₊ (RoHS compliant) is a wideband amplifier offering high dynamic range. Lead finish is SnAgNi. It has repeatable performance from lot to lot, and is enclosed in a SOT-89 package. It uses patented Transient Protected Darlington configuration and is fabricated using InGaP HBT technology. Expected MTTF is 7,000 years at 85°C case temperature. Gali₅₁₊ is designed to be rugged for ESD and supply switch-on transients.

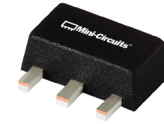

Generic photo used for illustration purposes only

Gali₅₁₊

CASE STYLE: DF782

+RoHS Compliant

The +Suffix identifies RoHS Compliance. See our web site for RoHS Compliance methodologies and qualifications

simplified schematic and pin description



Function	Pin Number	Description
RF IN	1	RF input pin. This pin requires the use of an external DC blocking capacitor chosen for the frequency of operation.
RF-OUT and DC-IN	3	RF output and bias pin. DC voltage is present on this pin; therefore a DC blocking capacitor is necessary for proper operation. An RF choke is needed to feed DC bias without loss of RF signal due to the bias connection, as shown in "Recommended Application Circuit".
GND	2,4	Connections to ground. Use via holes as shown in "Suggested Layout for PCB Design" to reduce ground path inductance for best performance.

Notes

- Performance and quality attributes and conditions not expressly stated in this specification document are intended to be excluded and do not form a part of this specification document.
- Electrical specifications and performance data contained in this specification document are based on Mini-Circuit's applicable established test performance criteria and measurement instructions.
- The parts covered by this specification document are subject to Mini-Circuits standard limited warranty and terms and conditions (collectively, "Standard Terms"); Purchasers of this part are entitled to the rights and benefits contained therein. For a full statement of the Standard Terms and the exclusive rights and remedies thereunder, please visit Mini-Circuits' website at www.minicircuits.com/MCLStore/terms.jsp



Electrical Specifications at 25°C and 65mA, unless noted

Parameter		Min.	Typ.	Max.	Units
Frequency Range*		DC		4	GHz
Gain	f=0.1 GHz	—	18.1	—	dB
	f=1 GHz	—	17.5	—	
	f=2 GHz	14	16.1	—	
	f=3 GHz	—	14.7	—	
	f=4 GHz	—	13.7	—	
	f=5 GHz	—	13.4	—	
Input Return Loss	f= DC to 3 GHz		17.5		dB
	f= 3 to 4 GHz		21		
Output Return Loss	f= DC to 3 GHz		14		dB
	f= 3 to 4 GHz		11.5		
Output Power @ 1 dB compression	f=1 GHz	16.5	18.0	—	dBm
Output IP3	f=1 GHz		35		dBm
Noise Figure	f=1 GHz		3.5		dB
Recommended Device Operating Current			65		mA
Device Operating Voltage		4.2	4.5	5.5	V
Device Voltage Variation vs. Temperature at 65 mA			-3.2		mV/°C
Device Voltage Variation vs. Current at 25°C			5.8		mV/mA
Thermal Resistance, junction-to-case ¹			78		°C/W

*Guaranteed specification DC-4 GHz. Low frequency cut off determined by external coupling capacitors.

Absolute Maximum Ratings

Parameter	Ratings
Operating Temperature*	-45°C to 85°C
Storage Temperature	-65°C to 150°C
Operating Current	85mA
Input Power	13dBm

Note: Permanent damage may occur if any of these limits are exceeded.

These ratings are not intended for continuous normal operation.

¹Case is defined as ground leads.

*Based on typical case temperature rise 4°C above ambient.

Notes

- A. Performance and quality attributes and conditions not expressly stated in this specification document are intended to be excluded and do not form a part of this specification document.
- B. Electrical specifications and performance data contained in this specification document are based on Mini-Circuit's applicable established test performance criteria and measurement instructions.
- C. The parts covered by this specification document are subject to Mini-Circuits standard limited warranty and terms and conditions (collectively, "Standard Terms"); Purchasers of this part are entitled to the rights and benefits contained therein. For a full statement of the Standard Terms and the exclusive rights and remedies thereunder, please visit Mini-Circuits' website at www.minicircuits.com/MCLStore/terms.jsp



Product Marking

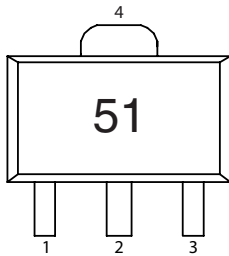

Markings in addition to model number designation may appear for internal quality control purposes.

Additional Detailed Technical Information

Additional information is available on our web site. To access this information enter the model number on our web site home page.

Performance data, graphs, s-parameter data set (.zip file)

Case Style: DF782

Plastic package, exposed paddle, lead finish: Matte-Tin

Tape & Reel: F55

7” reels with 20, 50, 100, 200, 500, 1K devices.

Suggested Layout for PCB Design: PL-019

Evaluation Board: TB-409-51+

Environmental Ratings: ENV08T2

Recommended Application Circuit

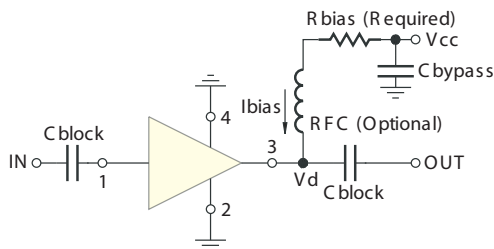

Test Board includes case, connectors, and components (in bold) soldered to PCB

R BIAS	
Vcc	“1%” Res. Values (ohms) for Optimum Biasing
7	40.2
8	53.6
9	68.1
10	82.5
11	97.6
12	113
13	127
14	143
15	158
16	174
17	191
18	205
19	221
20	237

Notes

- A. Performance and quality attributes and conditions not expressly stated in this specification document are intended to be excluded and do not form a part of this specification document.
- B. Electrical specifications and performance data contained in this specification document are based on Mini-Circuit's applicable established test performance criteria and measurement instructions.
- C. The parts covered by this specification document are subject to Mini-Circuits standard limited warranty and terms and conditions (collectively, "Standard Terms"); Purchasers of this part are entitled to the rights and benefits contained therein. For a full statement of the Standard Terms and the exclusive rights and remedies thereunder, please visit Mini-Circuits' website at www.minicircuits.com/MCLStore/terms.jsp



ESD Rating

Human Body Model (HBM): Class 1B (500v to < 1000v) in accordance with ANSI/ESD STM 5.1 - 2001

Machine Model (MM): Class M1 (< 100v) in accordance with ANSI/ESD STM 5.2 - 1999

MSL Rating

Moisture Sensitivity: MSL1 in accordance with IPC/JEDECJ-STD-020C

No.	Test Required	Condition	Standard	Quantity
1	Visual Inspection	Low Power Microscope Magnification 40x	MIP-IN-0003 (MCT spec)	45 units
2	Electrical Test	Room Temperature	SCD (MCL spec)	45 units
3	SAM Analysis	Less than 10% growth in term of delamination	J-Std-020C (Jedec Standard)	45 units
4	Moisture Sensitivity Level 1	Bake at 125°C for 24 hours Soak at 85°C/85%RH for 168 hours Reflow 3 cycles at 260°C peak	J-Std-020C (Jedec Standard)	45 units

MSL Test Flow Chart



Notes

- A. Performance and quality attributes and conditions not expressly stated in this specification document are intended to be excluded and do not form a part of this specification document.
- B. Electrical specifications and performance data contained in this specification document are based on Mini-Circuit's applicable established test performance criteria and measurement instructions.
- C. The parts covered by this specification document are subject to Mini-Circuits standard limited warranty and terms and conditions (collectively, "Standard Terms"); Purchasers of this part are entitled to the rights and benefits contained therein. For a full statement of the Standard Terms and the exclusive rights and remedies thereunder, please visit Mini-Circuits' website at www.minicircuits.com/MCLStore/terms.jsp



Typical Performance Data

**NOTE: Use PDF Bookmarks to view DATA at required conditions
or to view GRAPHS.**

Definitions:

Input Return Loss = -S11 (dB)

Gain(Power Gain) = S21 (dB)

Reverse Isolation = -S12 (dB)

Output Return Loss = -S22 (dB)

TEST CONDITIONS: Icc = 65mA, Vd = 4.54V @Temperature = +25degC

FREQ	Gain	Isolation	Input Return Loss	Output Return Loss	Stability		FREQ	IP3 Output	1dB Comp. Output	Noise Figure
(MHz)	(dB)	(dB)	(dB)	(dB)	K	Delta	(MHz)	(dBm)	(dBm)	(dB)
50	18.23	22.16	30.11	27.26	1.10	0.63	50	34.75	18.25	3.55
100	18.19	22.13	30.02	26.62	1.10	0.63	100	34.85	18.30	3.72
200	18.16	22.14	30.49	26.59	1.10	0.63	200	34.89	18.29	3.58
400	18.03	22.10	29.70	25.84	1.11	0.62	300	34.89	18.15	3.75
600	17.88	22.15	28.93	24.83	1.12	0.61	400	34.28	18.34	3.68
800	17.73	22.11	27.71	24.12	1.12	0.60	500	34.12	18.22	3.75
1000	17.53	22.16	26.47	23.47	1.14	0.58	600	34.13	18.09	3.74
1200	17.33	22.18	25.40	22.73	1.15	0.57	700	34.51	18.16	3.70
1400	17.12	22.19	23.94	22.06	1.16	0.55	800	34.68	18.22	3.76
1600	16.90	22.23	22.76	21.55	1.18	0.54	900	34.82	18.11	3.69
1800	16.67	22.30	21.49	21.24	1.20	0.52	1000	34.60	18.13	3.67
2000	16.46	22.32	20.36	20.89	1.21	0.50	1100	34.42	17.97	3.66
2200	16.22	22.36	19.30	20.67	1.23	0.48	1200	34.38	17.78	3.74
2400	15.98	22.42	18.39	20.45	1.25	0.47	1300	34.18	17.80	3.72
2600	15.76	22.45	17.53	20.11	1.27	0.45	1400	33.77	17.79	3.79
2800	15.54	22.53	16.81	19.83	1.29	0.43	1500	33.63	17.73	3.82
3000	15.34	22.58	16.01	19.48	1.31	0.42	1600	33.98	17.75	3.78
3200	15.15	22.64	15.53	19.35	1.33	0.41	1700	34.58	17.80	3.75
3400	14.98	22.69	15.00	19.01	1.35	0.40	1800	34.47	17.72	3.93
3600	14.81	22.77	14.59	18.92	1.38	0.39	1900	33.94	17.76	3.75
3800	14.67	22.75	14.30	18.63	1.39	0.38	2000	33.69	17.80	3.62
4000	14.54	22.84	14.09	18.90	1.41	0.37	2100	33.49	17.75	3.82
4200	14.45	22.87	13.91	18.97	1.43	0.37	2200	33.19	17.73	3.67
4400	14.35	22.86	13.95	19.29	1.44	0.37	2300	32.98	17.74	3.83
4600	14.30	22.89	13.91	19.57	1.45	0.36	2400	32.64	17.67	3.73
5000	14.26	22.94	13.86	20.92	1.47	0.36	2500	32.36	17.63	3.75
5500	14.33	22.82	13.78	22.59	1.44	0.36	2600	32.19	17.56	3.77
6000	14.53	22.58	13.40	23.56	1.38	0.38	2700	32.06	17.53	3.80
6500	14.67	22.10	13.18	20.01	1.31	0.41	2800	31.81	17.48	3.78
7000	14.52	21.55	12.76	15.14	1.25	0.44	2900	31.71	17.39	3.82
7500	13.58	21.11	12.04	11.57	1.27	0.44	3000	31.38	17.30	3.68
8000	12.05	20.71	11.17	9.08	1.34	0.44	3100	31.14	17.10	3.98
9000	8.26	19.05	9.04	7.13	1.49	0.42	3200	30.86	17.10	3.75
10000	5.21	16.72	8.20	6.58	1.49	0.40	3300	30.76	17.01	4.04
11000	3.26	14.00	8.59	6.97	1.39	0.38	3400	30.55	16.94	3.86
12000	2.13	11.07	9.37	8.27	1.24	0.39	3500	30.39	16.73	3.83
13000	1.25	7.59	10.65	11.36	1.10	0.47	3600	30.07	16.56	3.99
14000	0.13	4.95	9.00	10.18	1.00	0.61	3700	29.88	16.38	3.82
15000	-2.93	5.38	4.26	4.75	1.00	0.69	3800	29.69	16.17	4.01
16000	-5.89	6.94	2.99	3.35	1.11	0.69	4000	29.47	15.69	3.89

REV. X1
GALI-51+
120123
Page 1 of 11



IF/RF MICROWAVE COMPONENTS • ISO 9001 ISO 14001 AS 9100 CERTIFIED • RoHS compliant
P.O. Box 350166, Brooklyn, New York 11235-0003 (718) 934-4500 Fax (718) 332-4661



The Design Engineers Search Engine finds the model you need, Instantly • For detailed performance specs & shopping online see



Typical Performance Data

Definitions:

Input Return Loss = -S11 (dB)

Gain(Power Gain) = S21 (dB)

Reverse Isolation = -S12 (dB)

Output Return Loss = -S22 (dB)

TEST CONDITIONS: Icc = 52mA, Vd = 4.46V @Temperature = +25degC

FREQ	Gain	Isolation	Input Return Loss	Output Return Loss	Stability		FREQ	IP3 Output	1dB Comp. Output	Noise Figure
					K	Delta				
(MHz)	(dB)	(dB)	(dB)	(dB)	K	Delta	(MHz)	(dBm)	(dBm)	(dB)
50	18.05	21.99	26.96	31.78	1.10	0.63	50	31.43	16.25	3.46
100	18.01	21.85	26.81	30.52	1.10	0.64	100	31.62	16.37	3.64
200	17.98	21.90	26.93	30.80	1.10	0.64	200	31.63	16.23	3.48
400	17.84	21.98	26.63	29.19	1.11	0.62	300	31.60	16.07	3.69
600	17.70	21.97	26.45	27.42	1.12	0.61	400	31.09	16.33	3.63
800	17.55	21.96	25.55	26.21	1.12	0.60	500	31.03	16.29	3.66
1000	17.36	21.98	24.74	25.21	1.14	0.58	600	31.02	16.10	3.65
1200	17.17	22.01	23.88	24.14	1.15	0.57	700	31.40	16.23	3.62
1400	16.97	22.02	22.72	23.09	1.16	0.55	800	31.72	16.26	3.68
1600	16.74	22.09	21.63	22.43	1.18	0.53	900	31.79	16.25	3.59
1800	16.52	22.10	20.51	21.86	1.19	0.52	1000	31.68	16.22	3.59
2000	16.31	22.13	19.39	21.34	1.20	0.50	1100	31.43	16.03	3.58
2200	16.07	22.22	18.42	20.93	1.23	0.48	1200	31.43	15.66	3.64
2400	15.84	22.24	17.56	20.58	1.24	0.47	1300	31.32	15.74	3.61
2600	15.62	22.31	16.74	20.12	1.27	0.45	1400	30.98	15.73	3.71
2800	15.40	22.37	16.07	19.77	1.29	0.43	1500	30.93	15.65	3.74
3000	15.22	22.41	15.31	19.31	1.30	0.42	1600	31.23	15.70	3.70
3200	15.02	22.48	14.84	19.11	1.33	0.41	1700	31.82	15.77	3.64
3400	14.85	22.53	14.33	18.74	1.34	0.40	1800	31.77	15.68	3.84
3600	14.68	22.64	13.96	18.64	1.37	0.39	1900	31.41	15.80	3.67
3800	14.53	22.61	13.67	18.35	1.38	0.38	2000	31.20	15.78	3.52
4000	14.41	22.70	13.50	18.62	1.40	0.37	2100	31.06	15.64	3.74
4200	14.33	22.71	13.30	18.66	1.41	0.37	2200	30.95	15.75	3.56
4400	14.22	22.73	13.33	19.05	1.43	0.37	2300	30.90	15.87	3.74
4600	14.18	22.75	13.30	19.35	1.44	0.36	2400	30.85	15.81	3.63
5000	14.13	22.80	13.24	20.75	1.46	0.36	2500	30.64	15.87	3.66
5500	14.19	22.70	13.13	22.79	1.44	0.37	2600	30.69	15.78	3.68
6000	14.37	22.45	12.78	24.56	1.38	0.38	2700	30.56	15.80	3.72
6500	14.50	21.95	12.56	20.91	1.30	0.41	2800	30.53	15.72	3.68
7000	14.29	21.40	12.21	15.67	1.25	0.44	2900	30.35	15.74	3.75
7500	13.33	21.00	11.64	11.91	1.28	0.44	3000	30.22	15.71	3.61
8000	11.79	20.58	10.93	9.36	1.36	0.43	3100	29.97	15.61	3.89
9000	8.04	18.99	8.95	7.33	1.51	0.41	3200	29.87	15.69	3.64
10000	5.04	16.71	8.14	6.75	1.52	0.39	3300	29.76	15.67	3.94
11000	3.09	14.03	8.51	7.13	1.41	0.37	3400	29.63	15.60	3.77
12000	1.99	11.13	9.23	8.39	1.25	0.37	3500	29.37	15.45	3.72
13000	1.12	7.62	10.45	11.42	1.10	0.46	3600	29.03	15.28	3.88
14000	0.02	4.95	8.86	10.18	1.01	0.61	3700	28.76	15.17	3.75
15000	-3.03	5.38	4.23	4.75	1.00	0.69	3800	28.58	15.05	3.90
16000	-5.95	6.94	2.99	3.37	1.12	0.68	4000	28.50	14.74	3.78

REV. X1

GALI-51+

120123

Page 2 of 11



IF/RF MICROWAVE COMPONENTS • ISO 9001 ISO 14001 AS 9100 CERTIFIED • RoHS compliant

P.O. Box 350166, Brooklyn, New York 11235-0003 (718) 934-4500 Fax (718) 332-4661



The Design Engineers Search Engine finds the model you need, Instantly • For detailed performance specs & shopping online see



Typical Performance Data

Definitions:

Input Return Loss = -S11 (dB)

Gain(Power Gain) = S21 (dB)

Reverse Isolation = -S12 (dB)

Output Return Loss = -S22 (dB)

TEST CONDITIONS: Icc = 78mA, Vd = 4.61V @Temperature = +25degC

FREQ	Gain	Isolation	Input Return Loss	Output Return Loss	Stability		FREQ	IP3 Output	1dB Comp. Output	Noise Figure
					K	Delta				
(MHz)	(dB)	(dB)	(dB)	(dB)	K	Delta	(MHz)	(dBm)	(dBm)	(dB)
50	18.34	22.23	33.42	25.24	1.10	0.64	50	37.28	19.43	3.64
100	18.30	22.27	33.04	24.68	1.10	0.63	100	37.52	19.42	3.81
200	18.26	22.20	33.49	24.71	1.10	0.63	200	37.52	19.45	3.64
400	18.13	22.24	32.08	24.25	1.11	0.62	300	37.41	19.28	3.86
600	17.98	22.22	30.59	23.47	1.12	0.61	400	36.71	19.47	3.77
800	17.83	22.25	29.09	22.92	1.13	0.60	500	36.30	19.28	3.84
1000	17.63	22.25	27.50	22.41	1.14	0.58	600	36.14	19.17	3.82
1200	17.43	22.27	26.24	21.91	1.15	0.57	700	36.31	19.21	3.77
1400	17.22	22.29	24.72	21.37	1.16	0.55	800	36.45	19.22	3.84
1600	16.99	22.34	23.42	21.00	1.18	0.54	900	36.25	19.05	3.77
1800	16.76	22.39	22.14	20.73	1.20	0.52	1000	35.94	19.13	3.74
2000	16.55	22.39	20.94	20.54	1.21	0.50	1100	35.77	19.03	3.76
2200	16.31	22.45	19.91	20.40	1.23	0.48	1200	35.63	18.91	3.79
2400	16.07	22.53	18.99	20.29	1.26	0.46	1300	35.24	18.88	3.79
2600	15.85	22.56	18.04	20.05	1.27	0.45	1400	34.93	18.87	3.88
2800	15.63	22.63	17.31	19.81	1.30	0.43	1500	34.77	18.78	3.91
3000	15.43	22.66	16.54	19.53	1.31	0.42	1600	35.10	18.81	3.87
3200	15.24	22.73	15.99	19.42	1.34	0.41	1700	35.15	18.81	3.83
3400	15.07	22.78	15.47	19.12	1.36	0.40	1800	34.74	18.73	4.03
3600	14.89	22.86	15.08	19.05	1.38	0.39	1900	34.27	18.76	3.83
3800	14.75	22.85	14.76	18.77	1.39	0.38	2000	34.03	18.78	3.72
4000	14.63	22.95	14.56	19.04	1.42	0.37	2100	33.73	18.70	3.92
4200	14.53	22.98	14.38	19.08	1.44	0.37	2200	33.35	18.63	3.75
4400	14.43	22.97	14.42	19.38	1.45	0.36	2300	32.97	18.51	3.92
4600	14.38	22.99	14.37	19.66	1.46	0.36	2400	32.61	18.41	3.83
5000	14.34	23.06	14.36	20.89	1.48	0.36	2500	32.27	18.33	3.83
5500	14.42	22.92	14.27	22.34	1.45	0.36	2600	32.07	18.27	3.88
6000	14.64	22.71	13.90	22.96	1.39	0.38	2700	31.81	18.21	3.90
6500	14.81	22.20	13.66	19.53	1.31	0.41	2800	31.64	18.13	3.86
7000	14.68	21.64	13.20	14.87	1.24	0.44	2900	31.44	18.08	3.91
7500	13.79	21.20	12.35	11.38	1.26	0.45	3000	31.18	17.93	3.80
8000	12.27	20.77	11.36	8.92	1.33	0.44	3100	30.85	17.71	4.08
9000	8.44	19.10	9.09	7.00	1.47	0.43	3200	30.71	17.69	3.86
10000	5.38	16.74	8.24	6.45	1.47	0.41	3300	30.48	17.59	4.12
11000	3.39	14.00	8.65	6.86	1.37	0.39	3400	30.31	17.52	3.96
12000	2.25	11.04	9.51	8.18	1.23	0.40	3500	30.19	17.33	3.91
13000	1.36	7.56	10.84	11.35	1.09	0.48	3600	29.85	17.16	4.08
14000	0.21	4.95	9.12	10.19	1.00	0.62	3700	29.69	16.95	3.94
15000	-2.85	5.36	4.30	4.74	1.00	0.69	3800	29.42	16.76	4.13
16000	-5.82	6.93	3.00	3.34	1.11	0.69	4000	29.19	16.30	4.00

REV. X1
GALI-51+
120123
Page 3 of 11



IF/RF MICROWAVE COMPONENTS • ISO 9001 ISO 14001 AS 9100 CERTIFIED • RoHS compliant
P.O. Box 350166, Brooklyn, New York 11235-0003 (718) 934-4500 Fax (718) 332-4661



The Design Engineers Search Engine finds the model you need, Instantly • For detailed performance specs & shopping online see



Typical Performance Data

Definitions:

Input Return Loss = -S11 (dB)

Gain(Power Gain) = S21 (dB)

Reverse Isolation = -S12 (dB)

Output Return Loss = -S22 (dB)

TEST CONDITIONS: Icc = 65mA, Vd = 4.78V @Temperature = -45degC

FREQ	Gain	Isolation	Input Return Loss	Output Return Loss	Stability		FREQ	IP3 Output	1dB Comp. Output	Noise Figure
					K	Delta				
(MHz)	(dB)	(dB)	(dB)	(dB)	K	Delta	(MHz)	(dBm)	(dBm)	(dB)
50	18.30	22.10	28.67	28.12	1.09	0.64	50	35.52	18.41	3.10
100	18.27	22.09	27.26	28.30	1.09	0.64	100	35.60	18.48	3.26
200	18.23	22.15	26.80	29.20	1.10	0.64	200	35.65	18.37	3.09
400	18.12	22.08	30.40	25.20	1.10	0.63	300	35.78	18.31	3.38
600	17.98	22.10	29.02	24.70	1.11	0.62	400	35.18	18.53	3.19
800	17.83	22.11	27.95	23.70	1.12	0.61	500	35.11	18.45	3.21
1000	17.65	22.13	26.25	23.86	1.13	0.59	600	35.13	18.32	3.22
1200	17.46	22.13	25.90	22.75	1.14	0.58	700	35.54	18.39	3.15
1400	17.27	22.15	24.43	21.90	1.15	0.57	800	35.85	18.41	3.23
1600	17.05	22.21	23.50	21.08	1.17	0.55	900	35.97	18.35	3.12
1800	16.83	22.23	22.12	21.13	1.18	0.53	1000	35.73	18.34	3.11
2000	16.61	22.25	21.07	20.77	1.19	0.52	1100	35.58	18.19	3.11
2200	16.38	22.28	20.00	20.47	1.21	0.50	1200	35.55	17.96	3.15
2400	16.15	22.34	19.05	20.22	1.23	0.48	1300	35.36	18.02	3.15
2600	15.93	22.42	18.11	19.79	1.25	0.46	1400	35.09	17.99	3.24
2800	15.71	22.48	17.22	19.73	1.27	0.45	1500	34.95	17.94	3.23
3000	15.52	22.47	16.41	19.40	1.29	0.44	1600	35.29	17.98	3.21
3200	15.34	22.55	16.04	19.17	1.31	0.42	1700	35.98	18.03	3.17
3400	15.18	22.60	15.79	18.91	1.33	0.41	1800	35.94	17.98	3.34
3600	15.01	22.72	15.41	19.11	1.36	0.40	1900	35.52	18.06	3.16
3800	14.88	22.64	15.07	19.00	1.36	0.40	2000	35.27	18.08	3.05
4000	14.76	22.73	14.88	19.29	1.39	0.39	2100	35.22	17.99	3.21
4200	14.67	22.75	14.75	19.72	1.40	0.38	2200	34.86	18.07	3.05
4400	14.57	22.76	14.93	19.90	1.41	0.38	2300	34.73	18.10	3.22
4600	14.52	22.82	14.86	19.65	1.42	0.37	2400	34.51	18.06	3.16
5000	14.47	22.87	14.93	20.18	1.44	0.37	2500	34.13	18.10	3.15
5500	14.54	22.77	14.33	21.13	1.41	0.38	2600	34.14	18.00	3.15
6000	14.84	22.58	13.60	23.71	1.35	0.40	2700	34.10	17.97	3.20
6500	15.14	22.00	14.24	20.79	1.26	0.44	2800	33.56	17.91	3.14
7000	15.12	21.47	13.71	14.17	1.19	0.48	2900	33.61	17.93	3.21
7500	14.36	21.02	12.05	10.64	1.17	0.49	3000	33.33	17.88	3.07
8000	13.06	20.61	11.01	8.87	1.22	0.48	3100	33.15	17.73	3.33
9000	9.45	18.83	9.60	7.13	1.34	0.46	3200	32.78	17.70	3.14
10000	5.94	16.97	7.45	5.52	1.35	0.47	3300	32.72	17.65	3.39
11000	3.98	14.14	8.12	6.55	1.27	0.41	3400	32.53	17.60	3.20
12000	3.22	10.82	10.28	8.72	1.15	0.43	3500	32.25	17.44	3.18
13000	1.81	7.81	9.25	8.66	1.03	0.53	3600	32.01	17.29	3.28
14000	0.80	4.87	9.68	11.90	0.95	0.60	3700	31.75	17.15	3.20
15000	-1.62	4.48	4.29	4.71	0.93	0.80	3800	31.57	16.96	3.34
16000	-7.05	8.34	1.75	2.08	0.99	0.79	4000	31.42	16.58	3.22

REV. X1
GALI-51+
120123
Page 4 of 11



IF/RF MICROWAVE COMPONENTS • ISO 9001 ISO 14001 AS 9100 CERTIFIED • RoHS compliant
P.O. Box 350166, Brooklyn, New York 11235-0003 (718) 934-4500 Fax (718) 332-4661



The Design Engineers Search Engine finds the model you need, Instantly • For detailed performance specs & shopping online see



Typical Performance Data

Definitions:

Input Return Loss = -S11 (dB)

Gain(Power Gain) = S21 (dB)

Reverse Isolation = -S12 (dB)

Output Return Loss = -S22 (dB)

TEST CONDITIONS: Icc = 52mA, Vd = 4.69V @Temperature = -45degC

FREQ	Gain	Isolation	Input Return Loss	Output Return Loss	Stability		FREQ	IP3 Output	1dB Comp. Output	Noise Figure
					K	Delta				
(MHz)	(dB)	(dB)	(dB)	(dB)	K	Delta	(MHz)	(dBm)	(dBm)	(dB)
50	18.14	21.94	26.19	32.08	1.09	0.64	50	32.14	16.19	3.02
100	18.10	22.00	24.90	33.46	1.10	0.64	100	32.22	16.28	3.17
200	18.07	21.94	24.66	34.57	1.10	0.64	200	32.21	16.05	3.05
400	17.97	21.94	27.43	27.79	1.10	0.63	300	32.26	15.99	3.23
600	17.83	21.97	26.76	26.84	1.11	0.62	400	31.89	16.33	3.13
800	17.69	21.98	25.99	25.47	1.12	0.61	500	31.86	16.25	3.14
1000	17.51	21.98	24.67	25.37	1.13	0.59	600	31.86	16.13	3.15
1200	17.32	21.98	24.52	24.04	1.14	0.58	700	32.27	16.23	3.05
1400	17.13	22.03	23.27	22.98	1.15	0.56	800	32.55	16.24	3.18
1600	16.91	22.05	22.49	21.94	1.16	0.55	900	32.66	16.23	3.06
1800	16.69	22.10	21.18	21.79	1.18	0.53	1000	32.52	16.21	3.05
2000	16.48	22.11	20.21	21.29	1.19	0.51	1100	32.35	15.93	3.03
2200	16.26	22.18	19.17	20.85	1.21	0.50	1200	32.35	15.61	3.11
2400	16.03	22.24	18.26	20.43	1.23	0.48	1300	32.25	15.74	3.07
2600	15.80	22.25	17.42	19.87	1.25	0.46	1400	31.98	15.66	3.15
2800	15.58	22.34	16.52	19.68	1.27	0.45	1500	31.93	15.63	3.16
3000	15.40	22.36	15.72	19.25	1.28	0.43	1600	32.19	15.64	3.15
3200	15.22	22.43	15.43	18.95	1.30	0.42	1700	32.78	15.78	3.11
3400	15.07	22.44	15.15	18.69	1.32	0.41	1800	32.75	15.66	3.27
3600	14.89	22.56	14.76	18.83	1.35	0.40	1900	32.51	15.80	3.09
3800	14.77	22.52	14.46	18.78	1.35	0.40	2000	32.38	15.80	2.97
4000	14.64	22.59	14.26	19.02	1.38	0.39	2100	32.24	15.68	3.15
4200	14.56	22.58	14.13	19.46	1.38	0.39	2200	32.23	15.80	2.99
4400	14.47	22.64	14.30	19.73	1.40	0.38	2300	32.15	15.91	3.16
4600	14.42	22.70	14.27	19.55	1.42	0.37	2400	32.14	15.94	3.05
5000	14.36	22.75	14.29	20.15	1.43	0.37	2500	32.12	16.04	3.08
5500	14.42	22.65	13.68	21.24	1.41	0.38	2600	32.18	15.90	3.08
6000	14.70	22.46	13.03	24.18	1.35	0.40	2700	32.16	15.90	3.14
6500	14.98	21.87	13.58	21.54	1.26	0.44	2800	31.92	15.89	3.06
7000	14.94	21.35	13.07	14.51	1.19	0.47	2900	31.88	15.90	3.16
7500	14.12	20.91	11.65	10.91	1.18	0.48	3000	31.79	15.90	2.98
8000	12.82	20.51	10.76	9.13	1.23	0.47	3100	31.65	15.86	3.28
9000	9.23	18.80	9.49	7.31	1.36	0.45	3200	31.53	15.86	3.05
10000	5.76	16.95	7.42	5.65	1.37	0.46	3300	31.44	15.96	3.33
11000	3.83	14.16	8.05	6.69	1.29	0.39	3400	31.30	15.94	3.13
12000	3.08	10.87	10.10	8.82	1.16	0.42	3500	31.16	15.75	3.13
13000	1.70	7.84	9.07	8.70	1.03	0.52	3600	30.73	15.69	3.22
14000	0.70	4.88	9.53	11.87	0.95	0.59	3700	30.45	15.60	3.14
15000	-1.72	4.50	4.24	4.70	0.93	0.79	3800	30.22	15.50	3.24
16000	-7.12	8.36	1.74	2.09	1.00	0.79	4000	30.13	15.35	3.14

REV. X1
GALI-51+
120123
Page 5 of 11



IF/RF MICROWAVE COMPONENTS • ISO 9001 ISO 14001 AS 9100 CERTIFIED • RoHS compliant
P.O. Box 350166, Brooklyn, New York 11235-0003 (718) 934-4500 Fax (718) 332-4661



The Design Engineers Search Engine finds the model you need, Instantly • For detailed performance specs & shopping online see



Typical Performance Data

Definitions:

Input Return Loss = -S11 (dB)

Gain(Power Gain) = S21 (dB)

Reverse Isolation = -S12 (dB)

Output Return Loss = -S22 (dB)

TEST CONDITIONS: Icc = 78mA, Vd = 4.85V @Temperature = -45degC

FREQ	Gain	Isolation	Input Return Loss	Output Return Loss	Stability		FREQ	IP3 Output	1dB Comp. Output	Noise Figure
					K	Delta				
(MHz)	(dB)	(dB)	(dB)	(dB)	K	Delta	(MHz)	(dBm)	(dBm)	(dB)
50	18.40	22.02	30.98	25.86	1.08	0.66	50	37.83	19.71	3.16
100	18.36	22.18	29.34	26.36	1.09	0.64	100	38.11	19.73	3.35
200	18.33	22.21	28.69	27.20	1.10	0.64	200	38.09	19.73	3.15
400	18.22	22.17	32.62	23.71	1.10	0.63	300	38.03	19.59	3.43
600	18.08	22.19	30.72	23.39	1.11	0.62	400	37.46	19.77	3.24
800	17.93	22.21	29.27	22.66	1.12	0.61	500	37.36	19.64	3.30
1000	17.74	22.22	27.31	22.80	1.13	0.59	600	37.33	19.52	3.29
1200	17.56	22.23	26.84	21.91	1.14	0.58	700	37.56	19.56	3.21
1400	17.35	22.24	25.15	21.21	1.15	0.57	800	37.81	19.62	3.29
1600	17.13	22.29	24.12	20.53	1.17	0.55	900	37.75	19.46	3.21
1800	16.91	22.33	22.76	20.67	1.18	0.53	1000	37.67	19.53	3.18
2000	16.70	22.39	21.64	20.35	1.20	0.51	1100	37.50	19.42	3.19
2200	16.46	22.38	20.54	20.13	1.21	0.50	1200	37.55	19.27	3.22
2400	16.23	22.42	19.57	19.96	1.23	0.48	1300	37.14	19.27	3.21
2600	16.01	22.53	18.64	19.65	1.26	0.46	1400	36.80	19.26	3.30
2800	15.79	22.57	17.75	19.65	1.28	0.44	1500	36.64	19.22	3.33
3000	15.60	22.61	16.93	19.41	1.29	0.43	1600	37.00	19.26	3.27
3200	15.42	22.64	16.57	19.25	1.31	0.42	1700	37.44	19.26	3.25
3400	15.26	22.67	16.31	18.95	1.33	0.41	1800	37.23	19.22	3.40
3600	15.08	22.78	15.91	19.20	1.36	0.40	1900	36.78	19.26	3.25
3800	14.95	22.77	15.55	19.08	1.37	0.39	2000	36.50	19.31	3.13
4000	14.83	22.81	15.36	19.37	1.39	0.39	2100	36.34	19.26	3.29
4200	14.75	22.85	15.25	19.77	1.41	0.38	2200	35.92	19.23	3.15
4400	14.65	22.85	15.44	19.89	1.42	0.38	2300	35.57	19.16	3.30
4600	14.59	22.91	15.41	19.63	1.43	0.37	2400	35.19	19.06	3.20
5000	14.54	22.95	15.50	20.08	1.44	0.37	2500	34.78	19.03	3.22
5500	14.62	22.86	14.88	20.92	1.42	0.38	2600	34.62	18.96	3.22
6000	14.93	22.71	14.10	23.16	1.36	0.40	2700	34.43	18.93	3.28
6500	15.25	22.10	14.86	20.29	1.27	0.44	2800	34.01	18.89	3.20
7000	15.28	21.54	14.25	13.98	1.19	0.48	2900	33.81	18.86	3.27
7500	14.55	21.10	12.41	10.45	1.17	0.49	3000	33.59	18.75	3.15
8000	13.29	20.67	11.23	8.67	1.21	0.49	3100	33.40	18.54	3.42
9000	9.66	18.89	9.67	6.98	1.32	0.47	3200	33.15	18.50	3.23
10000	6.09	16.99	7.48	5.40	1.34	0.48	3300	32.96	18.43	3.45
11000	4.13	14.13	8.19	6.45	1.26	0.42	3400	32.84	18.39	3.28
12000	3.35	10.80	10.46	8.61	1.14	0.45	3500	32.60	18.20	3.27
13000	1.92	7.79	9.41	8.60	1.02	0.54	3600	32.41	18.07	3.38
14000	0.88	4.88	9.83	11.92	0.95	0.60	3700	32.12	17.91	3.29
15000	-1.54	4.48	4.35	4.73	0.93	0.80	3800	31.86	17.74	3.42
16000	-6.97	8.33	1.75	2.08	0.99	0.79	4000	31.78	17.29	3.32

REV. X1
GALI-51+
120123
Page 6 of 11



IF/RF MICROWAVE COMPONENTS • ISO 9001 ISO 14001 AS 9100 CERTIFIED • RoHS compliant
P.O. Box 350166, Brooklyn, New York 11235-0003 (718) 934-4500 Fax (718) 332-4661



The Design Engineers Search Engine finds the model you need, Instantly • For detailed performance specs & shopping online see



Typical Performance Data

Definitions:

Input Return Loss = -S11 (dB)

Gain(Power Gain) = S21 (dB)

Reverse Isolation = -S12 (dB)

Output Return Loss = -S22 (dB)

TEST CONDITIONS: Icc = 65mA, Vd = 4.36V @Temperature = +85degC

FREQ	Gain	Isolation	Input Return Loss	Output Return Loss	Stability		FREQ	IP3 Output	1dB Comp. Output	Noise Figure
					K	Delta				
(MHz)	(dB)	(dB)	(dB)	(dB)	K	Delta	(MHz)	(dBm)	(dBm)	(dB)
50	18.13	22.01	30.22	27.94	1.10	0.64	50	34.44	18.09	3.96
100	18.09	22.18	31.79	26.01	1.11	0.62	100	34.69	18.11	4.14
200	18.04	21.96	34.25	24.80	1.10	0.64	200	34.77	18.12	3.96
400	17.91	22.04	29.23	26.15	1.11	0.62	300	34.64	17.97	4.31
600	17.76	22.05	27.86	25.74	1.12	0.61	400	33.93	18.16	4.13
800	17.60	22.08	26.49	25.04	1.13	0.59	500	33.69	18.01	4.20
1000	17.40	22.12	25.37	24.50	1.14	0.58	600	33.57	17.90	4.18
1200	17.20	22.12	24.39	23.67	1.15	0.56	700	33.83	17.95	4.16
1400	16.99	22.14	23.09	22.85	1.17	0.55	800	34.02	17.97	4.18
1600	16.75	22.19	22.02	22.26	1.18	0.53	900	33.96	17.84	4.15
1800	16.52	22.23	20.85	21.77	1.20	0.51	1000	33.72	17.88	4.14
2000	16.30	22.27	19.75	21.25	1.22	0.49	1100	33.50	17.75	4.14
2200	16.06	22.34	18.72	20.88	1.24	0.47	1200	33.36	17.58	4.19
2400	15.81	22.44	17.88	20.64	1.27	0.45	1300	33.07	17.57	4.18
2600	15.59	22.44	16.97	20.24	1.28	0.44	1400	32.75	17.57	4.26
2800	15.36	22.52	16.25	19.92	1.31	0.42	1500	32.65	17.50	4.32
3000	15.15	22.54	15.49	19.51	1.32	0.41	1600	33.03	17.51	4.26
3200	14.95	22.65	14.90	19.30	1.35	0.40	1700	33.43	17.54	4.25
3400	14.76	22.71	14.22	18.91	1.37	0.38	1800	33.00	17.48	4.40
3600	14.57	22.83	13.76	18.72	1.40	0.37	1900	32.56	17.51	4.25
3800	14.43	22.81	13.35	18.37	1.41	0.37	2000	32.29	17.53	4.13
4000	14.30	22.88	13.10	18.60	1.44	0.36	2100	32.01	17.44	4.34
4200	14.20	22.95	12.94	18.70	1.46	0.36	2200	31.66	17.38	4.16
4400	14.10	22.90	12.99	19.01	1.46	0.35	2300	31.36	17.35	4.32
4600	14.04	22.94	13.00	19.49	1.48	0.35	2400	30.98	17.23	4.27
5000	13.99	22.97	13.03	21.33	1.50	0.35	2500	30.65	17.16	4.26
5500	14.05	22.87	12.98	23.76	1.48	0.35	2600	30.42	17.09	4.32
6000	14.16	22.56	12.71	24.15	1.42	0.37	2700	30.19	17.03	4.32
6500	14.10	22.17	12.22	20.06	1.36	0.38	2800	29.99	16.92	4.31
7000	13.71	21.62	11.93	16.15	1.33	0.40	2900	29.80	16.88	4.36
7500	12.64	21.12	11.87	12.63	1.38	0.40	3000	29.57	16.70	4.21
8000	10.99	20.76	11.30	9.54	1.49	0.39	3100	29.29	16.46	4.51
9000	7.07	19.15	8.62	7.05	1.64	0.39	3200	29.00	16.45	4.27
10000	4.36	16.60	8.32	7.27	1.62	0.36	3300	28.92	16.38	4.57
11000	2.57	13.81	8.97	7.68	1.50	0.35	3400	28.76	16.26	4.43
12000	1.10	11.23	8.75	7.92	1.34	0.36	3500	28.53	16.02	4.36
13000	0.40	7.67	10.71	12.42	1.18	0.40	3600	28.26	15.77	4.55
14000	-0.54	5.01	8.96	10.23	1.07	0.59	3700	28.00	15.62	4.35
15000	-4.33	6.40	3.79	4.23	1.08	0.65	3800	27.78	15.40	4.59
16000	-5.69	6.54	3.99	4.50	1.22	0.59	4000	27.41	14.96	4.43

REV. X1

GALI-51+

120123

Page 7 of 11



IF/RF MICROWAVE COMPONENTS • ISO 9001 ISO 14001 AS 9100 CERTIFIED • RoHS compliant

P.O. Box 350166, Brooklyn, New York 11235-0003 (718) 934-4500 Fax (718) 332-4661



The Design Engineers Search Engine finds the model you need, Instantly • For detailed performance specs & shopping online see



Typical Performance Data

Definitions:

Input Return Loss = -S11 (dB)

Gain(Power Gain) = S21 (dB)

Reverse Isolation = -S12 (dB)

Output Return Loss = -S22 (dB)

TEST CONDITIONS: Icc = 52mA, Vd = 4.28V @Temperature = +85degC

FREQ	Gain	Isolation	Input Return Loss	Output Return Loss	Stability		FREQ	IP3 Output	1dB Comp. Output	Noise Figure
					K	Delta				
(MHz)	(dB)	(dB)	(dB)	(dB)	K	Delta	(MHz)	(dBm)	(dBm)	(dB)
50	17.92	21.97	26.61	33.07	1.11	0.63	50	31.10	16.35	3.87
100	17.89	21.99	27.39	30.32	1.11	0.62	100	31.29	16.37	4.06
200	17.85	21.89	29.47	28.40	1.11	0.63	200	31.42	16.33	3.90
400	17.72	21.85	26.32	29.69	1.11	0.62	300	31.34	16.19	4.24
600	17.57	21.85	25.28	28.50	1.12	0.61	400	30.74	16.40	4.08
800	17.41	21.90	24.38	27.13	1.13	0.59	500	30.63	16.31	4.10
1000	17.22	21.92	23.52	26.12	1.14	0.58	600	30.57	16.14	4.11
1200	17.01	21.93	22.76	24.86	1.15	0.56	700	30.93	16.25	4.06
1400	16.81	22.00	21.75	23.79	1.17	0.55	800	31.18	16.28	4.11
1600	16.59	22.00	20.75	22.94	1.18	0.53	900	31.20	16.22	4.07
1800	16.35	22.07	19.75	22.29	1.20	0.51	1000	31.05	16.24	4.07
2000	16.14	22.11	18.82	21.56	1.22	0.49	1100	30.86	15.97	4.05
2200	15.90	22.16	17.82	21.05	1.24	0.48	1200	30.76	15.68	4.11
2400	15.66	22.19	17.02	20.64	1.25	0.46	1300	30.67	15.71	4.08
2600	15.43	22.28	16.20	20.18	1.28	0.44	1400	30.33	15.75	4.19
2800	15.20	22.38	15.53	19.77	1.30	0.42	1500	30.28	15.69	4.22
3000	15.01	22.42	14.82	19.26	1.32	0.41	1600	30.62	15.66	4.18
3200	14.79	22.49	14.25	19.01	1.34	0.40	1700	31.19	15.78	4.14
3400	14.61	22.55	13.64	18.57	1.36	0.39	1800	31.05	15.67	4.34
3600	14.43	22.66	13.19	18.29	1.39	0.38	1900	30.69	15.79	4.18
3800	14.29	22.63	12.77	17.98	1.40	0.37	2000	30.46	15.78	4.03
4000	14.14	22.73	12.57	18.13	1.43	0.36	2100	30.27	15.65	4.26
4200	14.05	22.81	12.43	18.24	1.45	0.36	2200	30.10	15.70	4.05
4400	13.95	22.74	12.44	18.59	1.45	0.36	2300	30.01	15.82	4.28
4600	13.90	22.83	12.47	19.06	1.47	0.35	2400	29.83	15.75	4.18
5000	13.86	22.80	12.47	20.95	1.48	0.35	2500	29.60	15.77	4.17
5500	13.89	22.70	12.46	23.73	1.47	0.35	2600	29.58	15.71	4.21
6000	13.99	22.42	12.15	25.16	1.41	0.37	2700	29.32	15.65	4.24
6500	13.90	22.02	11.73	21.05	1.36	0.38	2800	29.25	15.57	4.21
7000	13.50	21.46	11.52	16.71	1.33	0.40	2900	29.13	15.55	4.29
7500	12.41	21.01	11.55	13.02	1.39	0.39	3000	28.92	15.47	4.12
8000	10.77	20.65	11.10	9.79	1.51	0.39	3100	28.73	15.29	4.41
9000	6.90	19.09	8.58	7.23	1.66	0.38	3200	28.53	15.36	4.15
10000	4.21	16.60	8.27	7.44	1.65	0.35	3300	28.47	15.33	4.48
11000	2.43	13.83	8.91	7.82	1.52	0.34	3400	28.26	15.20	4.30
12000	0.99	11.28	8.67	8.03	1.36	0.35	3500	28.08	14.98	4.26
13000	0.29	7.71	10.57	12.44	1.19	0.39	3600	27.77	14.80	4.45
14000	-0.63	5.02	8.87	10.25	1.07	0.59	3700	27.59	14.64	4.25
15000	-4.40	6.41	3.78	4.24	1.08	0.65	3800	27.33	14.43	4.48
16000	-5.74	6.55	3.98	4.51	1.22	0.59	4000	27.10	14.11	4.32

REV. X1
GALI-51+
120123
Page 8 of 11



IF/RF MICROWAVE COMPONENTS • ISO 9001 ISO 14001 AS 9100 CERTIFIED • RoHS compliant
P.O. Box 350166, Brooklyn, New York 11235-0003 (718) 934-4500 Fax (718) 332-4661



The Design Engineers Search Engine finds the model you need, Instantly • For detailed performance specs & shopping online see



Typical Performance Data

Definitions:

Input Return Loss = -S11 (dB)

Gain(Power Gain) = S21 (dB)

Reverse Isolation = -S12 (dB)

Output Return Loss = -S22 (dB)

TEST CONDITIONS: Icc = 78mA, Vd = 4.44V @Temperature = +85degC

FREQ	Gain	Isolation	Input Return Loss	Output Return Loss	Stability		FREQ	IP3 Output	1dB Comp. Output	Noise Figure
					K	Delta				
(MHz)	(dB)	(dB)	(dB)	(dB)	K	Delta	(MHz)	(dBm)	(dBm)	(dB)
50	18.25	22.24	33.48	25.29	1.10	0.63	50	37.31	19.17	4.04
100	18.21	22.12	36.28	24.15	1.10	0.64	100	37.60	19.14	4.24
200	18.16	22.11	39.93	23.18	1.10	0.63	200	37.51	19.18	4.05
400	18.02	22.20	31.85	24.31	1.11	0.62	300	37.13	18.98	4.43
600	17.87	22.16	29.66	24.12	1.12	0.61	400	36.39	19.17	4.21
800	17.71	22.20	28.03	23.69	1.13	0.59	500	35.80	18.98	4.31
1000	17.51	22.21	26.55	23.42	1.14	0.58	600	35.47	18.83	4.26
1200	17.30	22.25	25.43	22.87	1.16	0.56	700	35.46	18.87	4.26
1400	17.09	22.26	24.04	22.22	1.17	0.55	800	35.34	18.89	4.29
1600	16.85	22.30	22.80	21.74	1.19	0.53	900	35.07	18.69	4.26
1800	16.62	22.37	21.51	21.45	1.21	0.51	1000	34.61	18.81	4.20
2000	16.40	22.36	20.40	21.03	1.22	0.50	1100	34.34	18.67	4.24
2200	16.15	22.45	19.31	20.79	1.24	0.47	1200	34.19	18.58	4.28
2400	15.90	22.50	18.42	20.64	1.27	0.46	1300	33.71	18.49	4.28
2600	15.68	22.53	17.46	20.33	1.29	0.44	1400	33.47	18.52	4.37
2800	15.44	22.60	16.72	20.11	1.31	0.43	1500	33.28	18.40	4.40
3000	15.24	22.68	15.92	19.71	1.33	0.41	1600	33.50	18.44	4.35
3200	15.02	22.74	15.29	19.54	1.36	0.40	1700	33.25	18.39	4.32
3400	14.85	22.81	14.61	19.21	1.38	0.38	1800	32.77	18.29	4.51
3600	14.66	22.89	14.14	19.06	1.40	0.37	1900	32.43	18.27	4.36
3800	14.51	22.88	13.69	18.69	1.41	0.37	2000	32.12	18.30	4.20
4000	14.37	22.99	13.44	18.96	1.44	0.36	2100	31.80	18.17	4.41
4200	14.28	23.03	13.29	19.07	1.46	0.36	2200	31.45	18.05	4.27
4400	14.18	22.97	13.33	19.39	1.47	0.36	2300	31.02	17.97	4.43
4600	14.12	23.07	13.33	19.86	1.49	0.35	2400	30.63	17.81	4.36
5000	14.07	23.07	13.39	21.72	1.50	0.35	2500	30.31	17.70	4.35
5500	14.12	22.94	13.34	24.03	1.48	0.35	2600	30.06	17.61	4.41
6000	14.23	22.67	13.05	23.91	1.43	0.36	2700	29.73	17.55	4.42
6500	14.18	22.28	12.51	19.82	1.37	0.38	2800	29.50	17.43	4.41
7000	13.81	21.74	12.21	15.95	1.34	0.40	2900	29.26	17.36	4.46
7500	12.73	21.22	12.07	12.55	1.38	0.40	3000	29.03	17.21	4.30
8000	11.08	20.85	11.40	9.48	1.49	0.39	3100	28.82	16.98	4.61
9000	7.15	19.18	8.63	6.99	1.63	0.39	3200	28.55	16.97	4.39
10000	4.42	16.61	8.33	7.21	1.61	0.36	3300	28.38	16.86	4.66
11000	2.63	13.79	8.99	7.62	1.49	0.35	3400	28.18	16.76	4.51
12000	1.16	11.22	8.79	7.87	1.33	0.37	3500	27.96	16.50	4.47
13000	0.45	7.64	10.83	12.41	1.17	0.41	3600	27.72	16.26	4.67
14000	-0.50	5.00	9.03	10.23	1.07	0.60	3700	27.44	16.09	4.46
15000	-4.29	6.41	3.80	4.22	1.08	0.65	3800	27.20	15.88	4.71
16000	-5.66	6.54	4.00	4.50	1.22	0.59	4000	26.75	15.45	4.65

REV. X1
GALI-51+
120123
Page 9 of 11



IF/RF MICROWAVE COMPONENTS • ISO 9001 ISO 14001 AS 9100 CERTIFIED • RoHS compliant
P.O. Box 350166, Brooklyn, New York 11235-0003 (718) 934-4500 Fax (718) 332-4661



The Design Engineers Search Engine finds the model you need, Instantly • For detailed performance specs & shopping online see



Typical Performance Curves

GAIN vs. TEMPERATURE

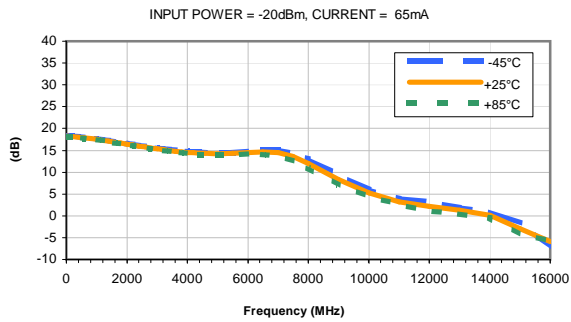

GAIN vs. CURRENT

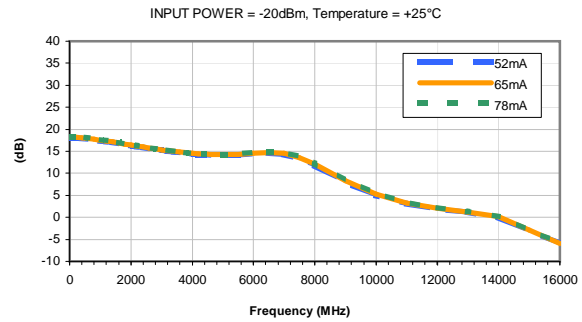

ISOLATION vs. TEMPERATURE

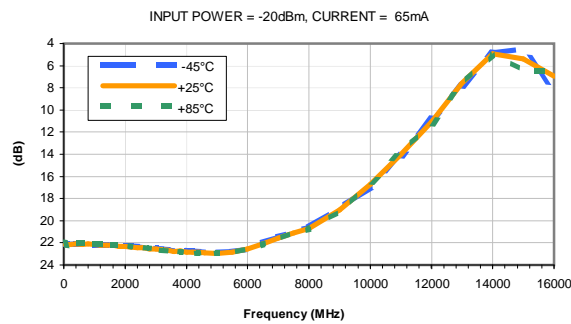

ISOLATION vs. CURRENT

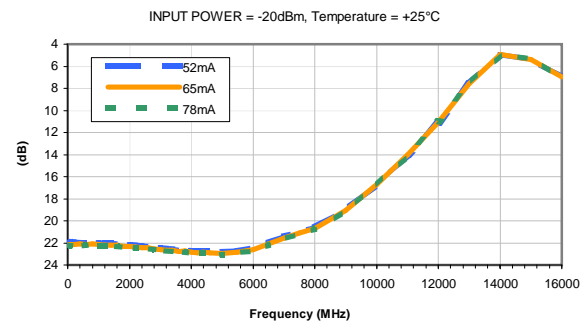

INPUT RETURN LOSS vs. TEMPERATURE

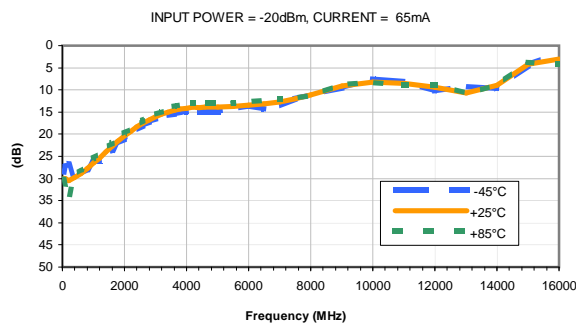

INPUT RETURN LOSS vs. CURRENT

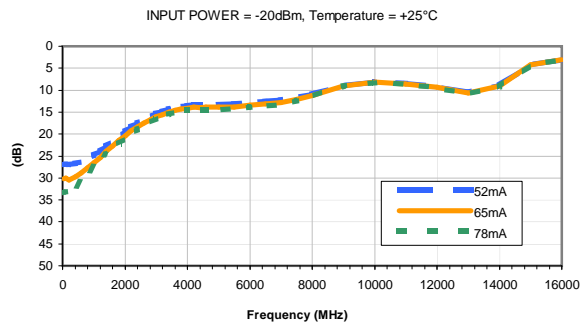

OUTPUT RETURN LOSS vs. TEMPERATURE

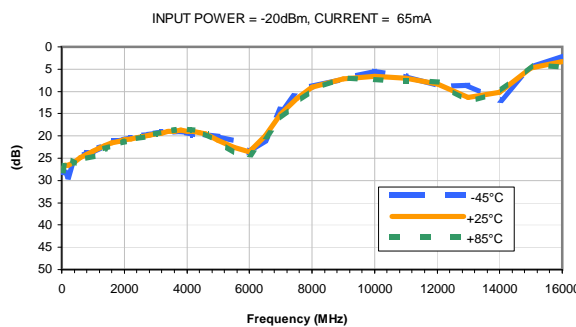

OUTPUT RETURN LOSS vs. CURRENT

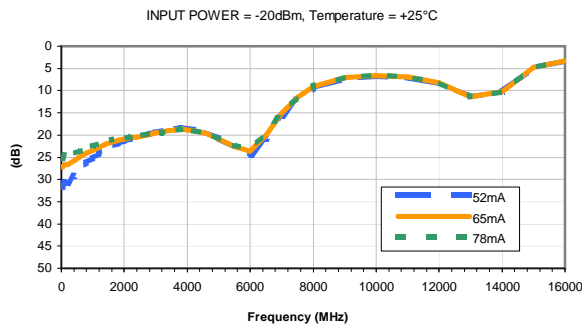

Typical Performance Curves

OUTPUT IP3 vs. TEMPERATURE

INPUT POWER = -20dBm, CURRENT = 65mA

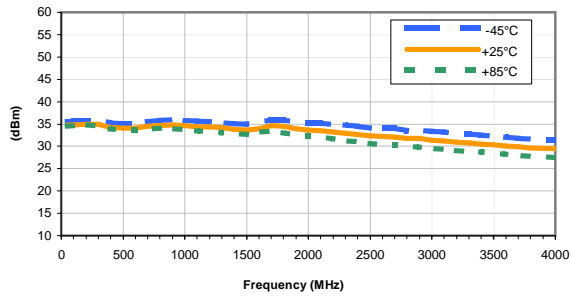

OUTPUT IP3 vs. CURRENT

INPUT POWER = -20dBm, Temperature = +25°C

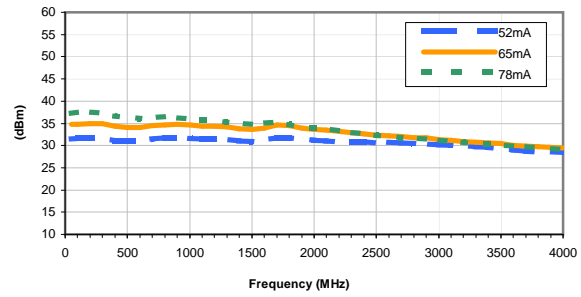

OUTPUT POWER at 1dB Compression vs. TEMPERATURE

CURRENT = 65mA

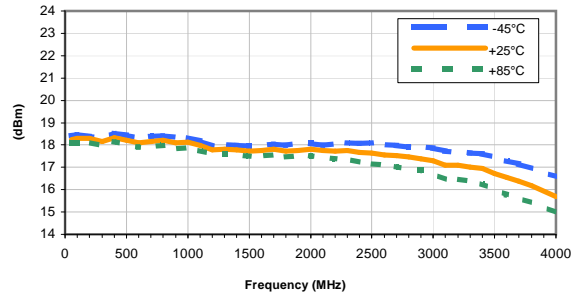

OUTPUT POWER at 1dB Compression vs. CURRENT

Temperature = +25°C

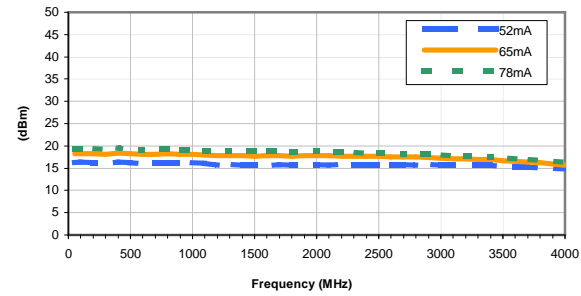

Noise Figure vs. TEMPERATURE

CURRENT = 65mA

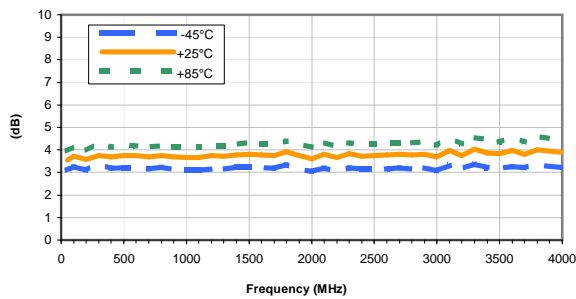

Noise Figure vs. CURRENT

Temperature = +25°C

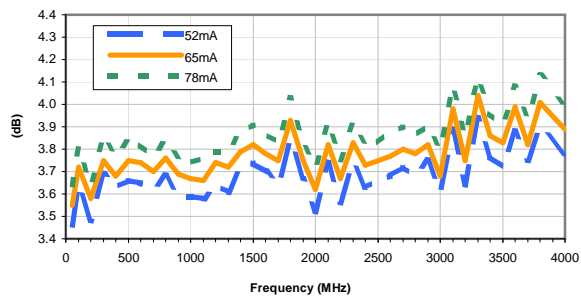

Typical Performance Curves

GAIN vs. TEMPERATURE

INPUT POWER = -20dBm, CURRENT = 65mA

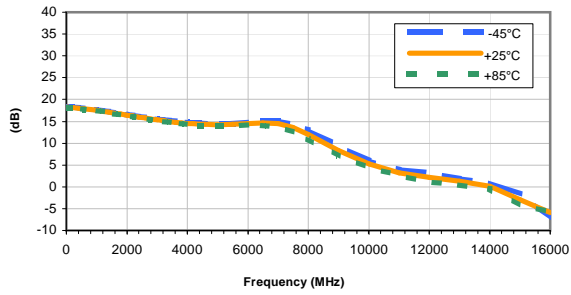

GAIN vs. CURRENT

INPUT POWER = -20dBm, Temperature = +25°C

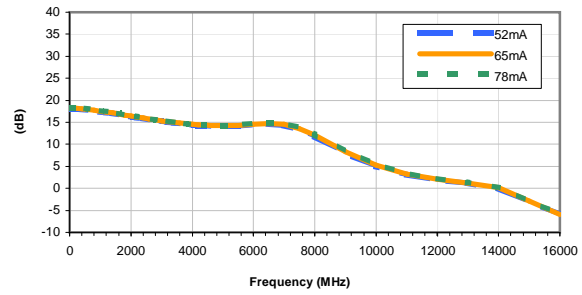

ISOLATION vs. TEMPERATURE

INPUT POWER = -20dBm, CURRENT = 65mA

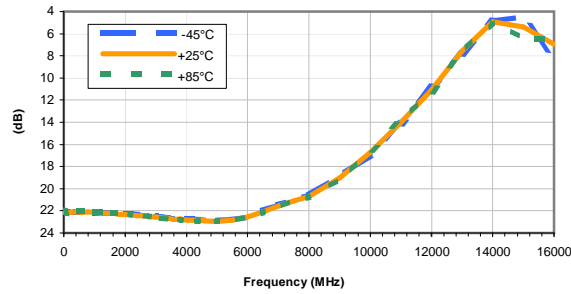

ISOLATION vs. CURRENT

INPUT POWER = -20dBm, Temperature = +25°C

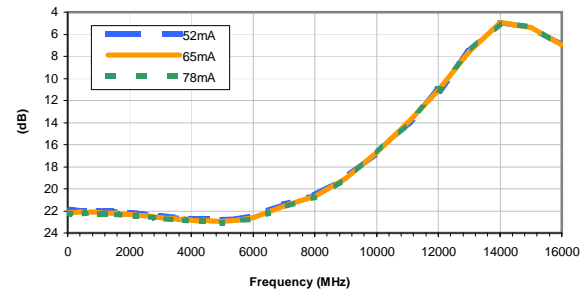

INPUT RETURN LOSS vs. TEMPERATURE

INPUT POWER = -20dBm, CURRENT = 65mA

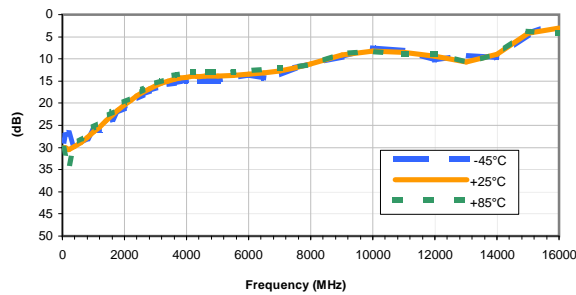

INPUT RETURN LOSS vs. CURRENT

INPUT POWER = -20dBm, Temperature = +25°C

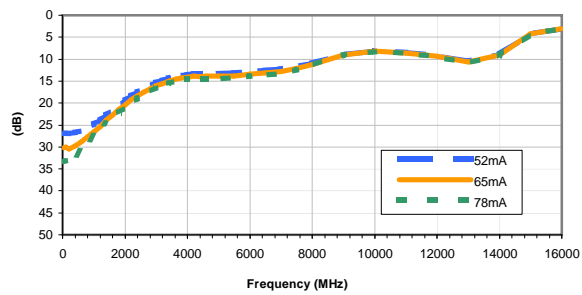

OUTPUT RETURN LOSS vs. TEMPERATURE

INPUT POWER = -20dBm, CURRENT = 65mA

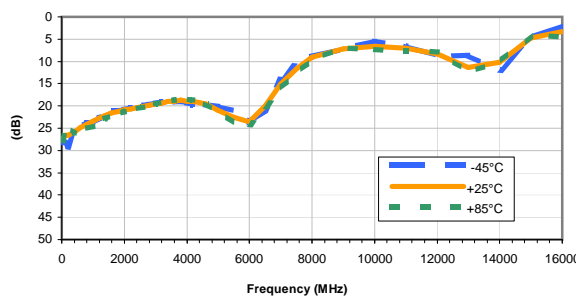

OUTPUT RETURN LOSS vs. CURRENT

INPUT POWER = -20dBm, Temperature = +25°C

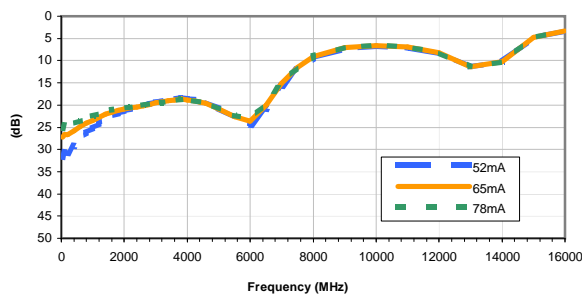

IF/RF MICROWAVE COMPONENTS • ISO 9001 ISO 14001 AS 9100 CERTIFIED • RoHS compliant
 P.O. Box 350166, Brooklyn, New York 11235-0003 (718) 934-4500 Fax (718) 332-4661



The Design Engineers Search Engine finds the model you need, Instantly • For detailed performance specs & shopping online see



Typical Performance Curves

OUTPUT IP3 vs. TEMPERATURE

INPUT POWER = -20dBm, CURRENT = 65mA

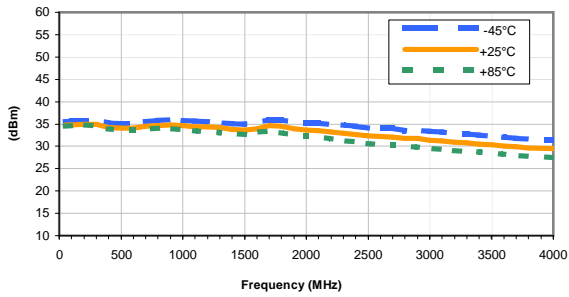

OUTPUT IP3 vs. CURRENT

INPUT POWER = -20dBm, Temperature = +25°C

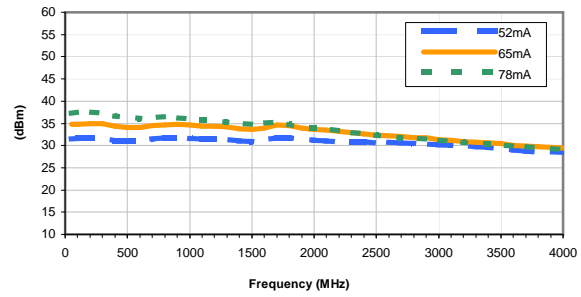

OUTPUT POWER at 1dB Compression vs. TEMPERATURE

CURRENT = 65mA

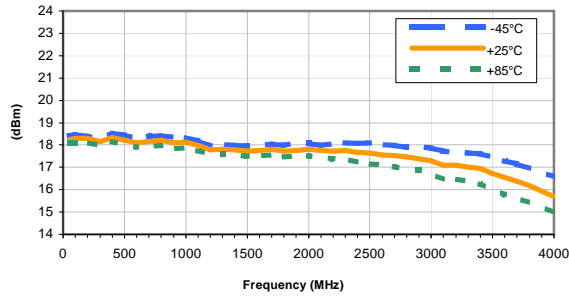

OUTPUT POWER at 1dB Compression vs. CURRENT

Temperature = +25°C

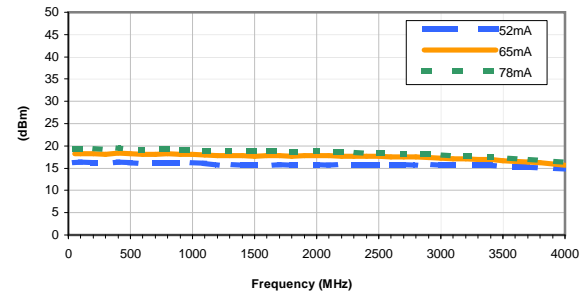

Noise Figure vs. TEMPERATURE

CURRENT = 65mA

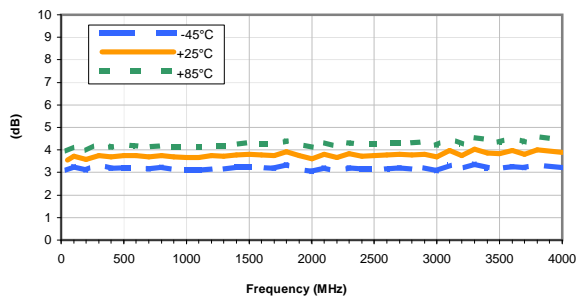

Noise Figure vs. CURRENT

Temperature = +25°C

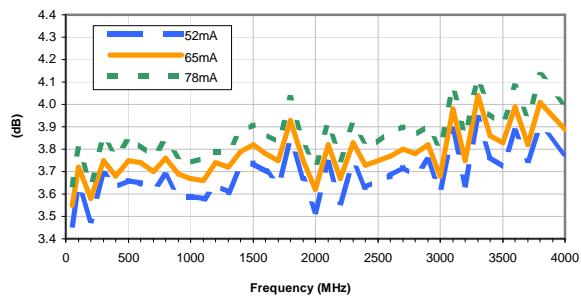

Outline Dimensions

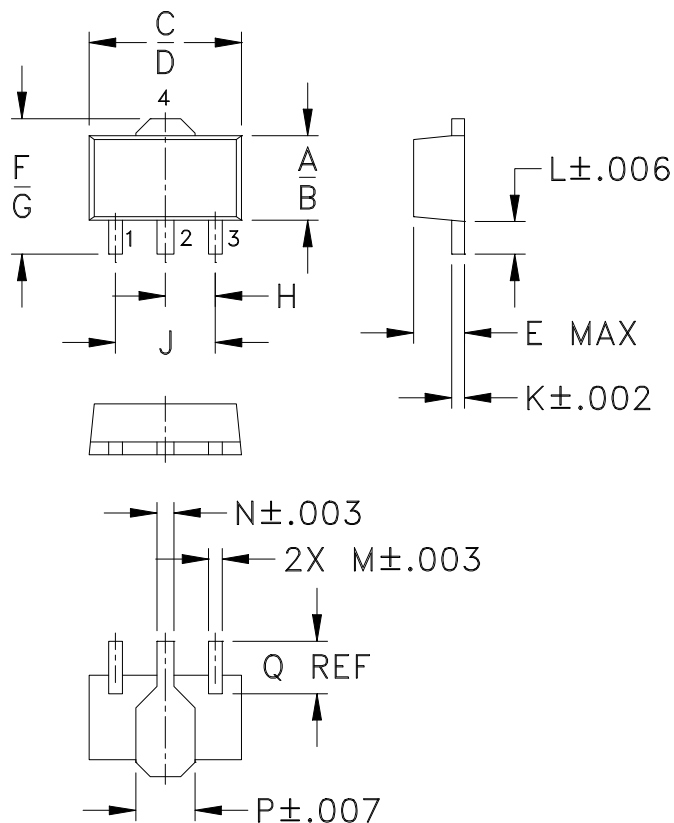

PCB Land Pattern

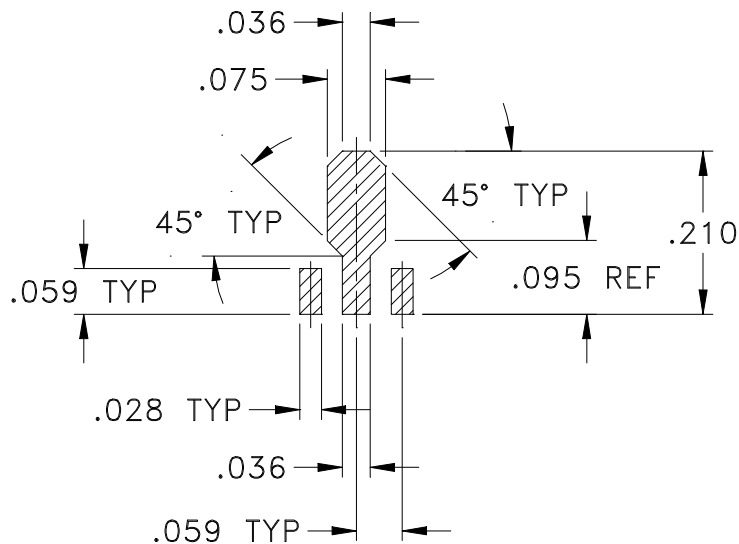

Suggested Layout,
Tolerance to be within $\pm .002$

CASE #	A	B	C	D	E	F	G	H	J	K	L	M
DF782	.102 (2.59)	.090 (2.29)	.181 (4.60)	.173 (4.39)	.063 (1.60)	.167 (4.24)	.155 (3.94)	.059 (1.50)	.118 (3.00)	.015 (0.38)	.041 (1.04)	.016 (0.41)

CASE #	N	P	Q	WT. GRAM
DF782	.019 (0.48)	.065 (1.65)	.062 (1.57)	.2

Dimensions are in inches (mm). Tolerances: 2 Pl. $\pm .01$; 3Pl. $\pm .005$

Notes:

- Case material: Plastic.
- Termination finish:
 For RoHS Case Styles: Tin-Silver alloy plate over Nickel barrier or Matte-Tin.
 All models, (+) suffix. See model Data sheet.
 For RoHS-5 Case Styles: Tin-Lead plate. All models, no (+) suffix.



INTERNET <http://www.minicircuits.com>

P.O. Box 350166, Brooklyn, New York 11235-0003 (718) 934-4500 Fax (718) 332-4661

Distribution Centers NORTH AMERICA 800-654-7949 • 417-335-5935 • Fax 417-335-5945 • EUROPE 44-1252-832600 • Fax 44-1252-837010

Mini-Circuits ISO 9001 & ISO 14001 Certified

Tape & Reel Packaging TR-F55

DEVICE ORIENTATION IN T&R

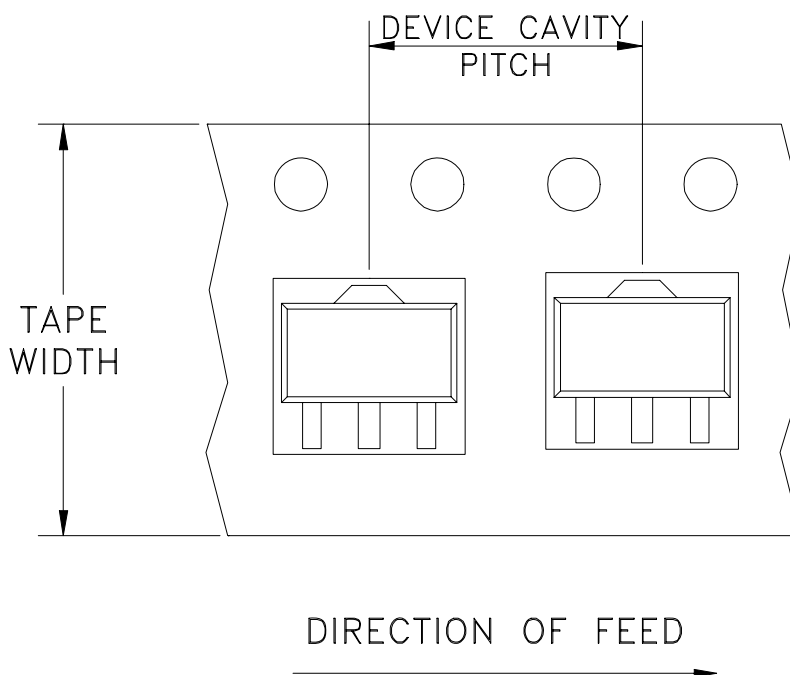

Tape Width, mm	Device Cavity Pitch, mm	Reel Size, inches	Devices per Reel	
12	8	7	Small quantity standard (see note)	20
				50
				100
				200
				500
			Standard	1000

Note: Please consult individual model data sheet to determine device per reel availability.

Mini-Circuits carrier tape materials provide protection from ESD (Electro-Static Discharge) during handling and transportation. Tapes are static dissipative and comply with industry standards EIA-481/EIA-541.

Go to: www.minicircuits.com/pages/pdfs/tape.pdf



INTERNET <http://www.minicircuits.com>

P.O. Box 350166, Brooklyn, New York 11235-0003 (718) 934-4500 Fax (718) 332-4661

Distribution Centers NORTH AMERICA 800-654-7949 • 417-335-5935 • Fax 417-335-5945 • EUROPE 44-1252-832600 • Fax 44-1252-837010

Mini-Circuits ISO 9001 & ISO 14001 Certified

THIRD ANGLE PROJECTION

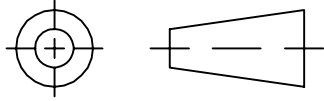

REVISIONS

REV	ECN No.	DESCRIPTION	DATE	DR	AUTH
A	M76190	CHANGED DISCRIPTION	04/01	GF	CT
B	M82575	UPDATED DRAWING	08/05/02	AV	LC
C	M102713	ADDED NOTE 2 & "...WITH SMOBC"	01/17/06	MMG	IL
D	M108434	UPDATED DRAWING PER TB-409+	11/14/06	PW	IG

SUGGESTED MOUNTING CONFIGURATION
FOR DF782 CASE STYLE, "mz" PIN CONNECTION

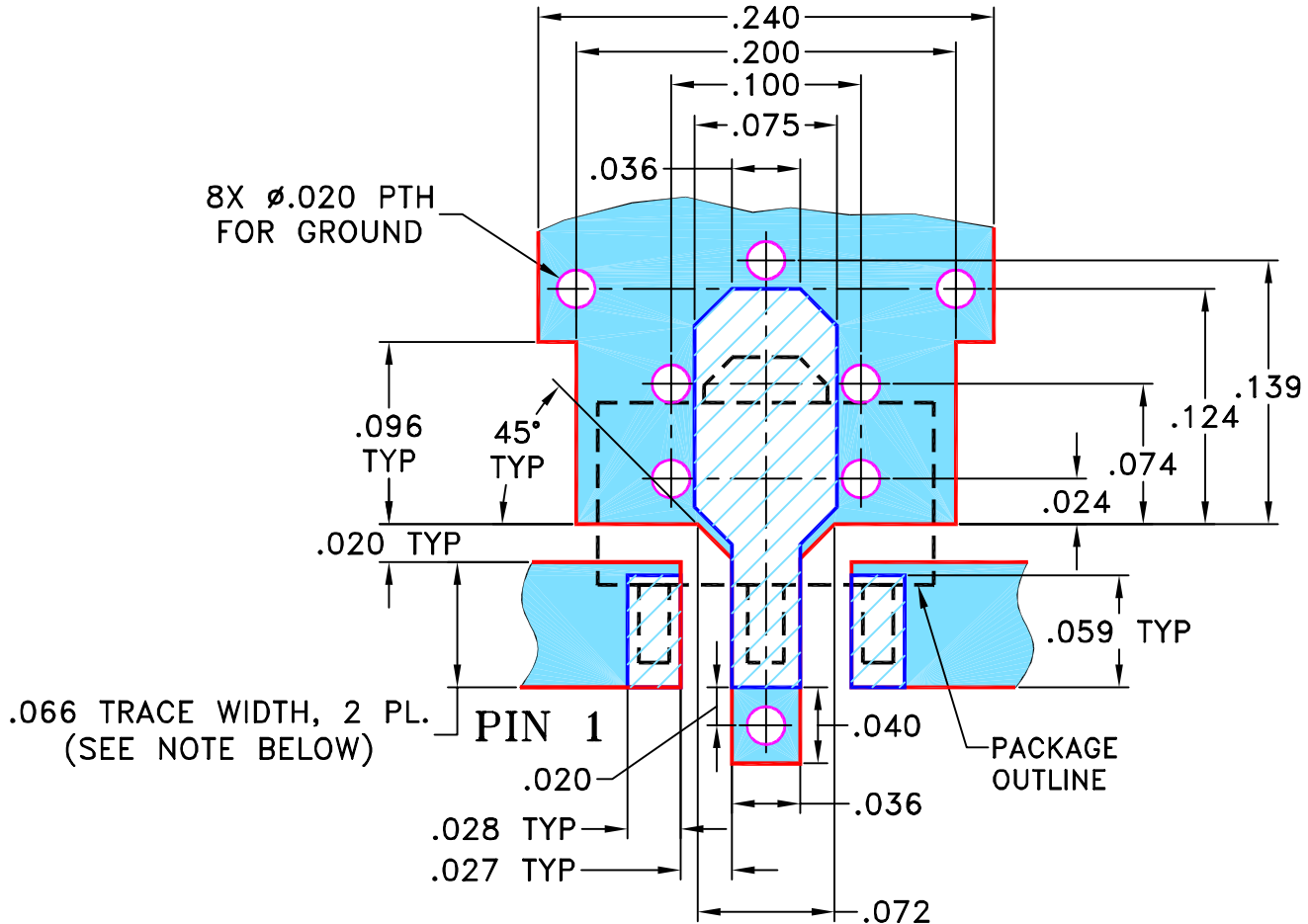

- NOTES:** 1. TRACE WIDTH IS SHOWN FOR ROGERS R04350B WITH DIELECTRIC THICKNESS .030" ± .002"; COPPER: 1/2 OZ. EACH SIDE. FOR OTHER MATERIALS TRACE WIDTH MAY NEED TO BE MODIFIED.
2. BOTTOM SIDE OF THE PCB IS CONTINUOUS GROUND PLANE.



DENOTES PCB COPPER LAYOUT WITH SMOBC (SOLDER MASK OVER BARE COPPER)



DENOTES COPPER LAND PATTERN FREE OF SOLDER MASK

UNLESS OTHERWISE SPECIFIED

INITIALS

DATE

DIMENSIONS ARE IN INCHES

DRAWN

AV

01/15/01

TOLERANCES ON:

CHECKED

YB

01/23/01

2 PL DECIMALS ± .005

APPROVED

DB

01/23/01

3 PL DECIMALS ±

ANGLES ±

FRACTIONS ±

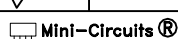

THIS DOCUMENT AND ITS CONTENTS ARE THE PROPERTY OF MINI-CIRCUITS. EXCEPT FOR USE EXPRESSLY GRANTED, IN WRITING, TO ITS VENDORS, VENDEE AND THE UNITED STATES GOVERNMENT, MINI-CIRCUITS RESERVES ALL PROPRIETARY DESIGN, USE, MANUFACTURING AND REPRODUCTION RIGHTS THERETO. THESE CONTENTS SHALL NOT BE USED, DUPLICATED OR DISCLOSED TO ANY OUTSIDE PARTY, IN WHOLE OR IN PART, WITHOUT WRITTEN PERMISSION OF MINI-CIRCUITS.



Mini-Circuits®

13 Neptune Avenue
Brooklyn NY 11235

PL, mz, DF782, GALI, TB-409-XXX+

SIZE

CODE IDENT

DRAWING NO:

REV:

A

15542

98-PL-019

D

FILE: 98PL019

SCALE:

10:1

SHEET:

1 OF 1

Evaluation Board and Circuit

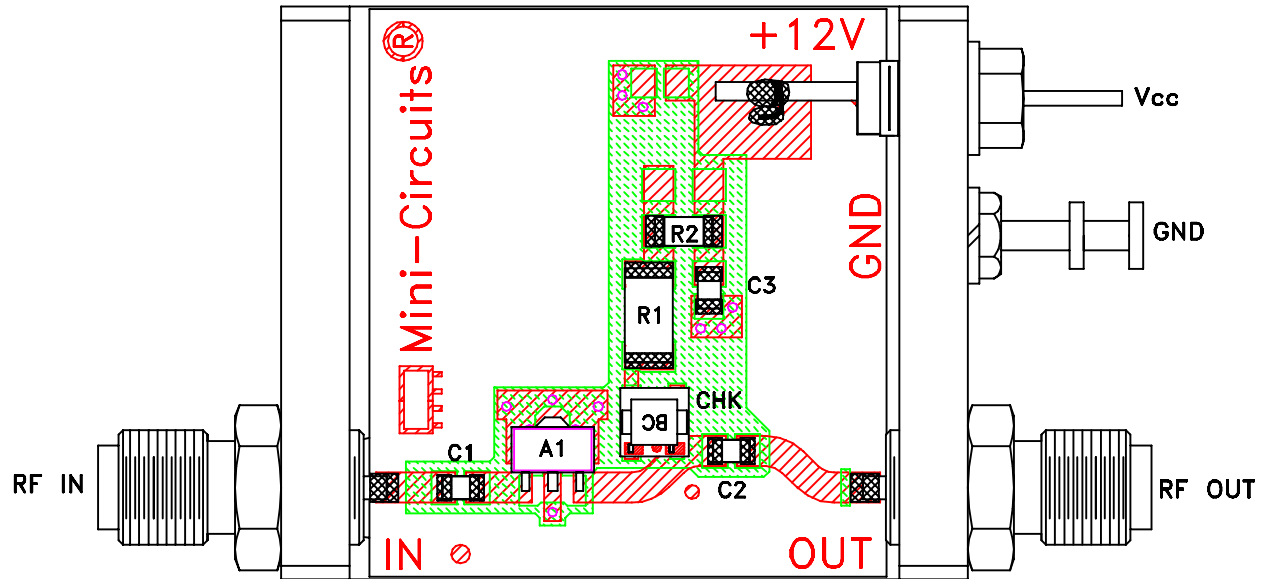

TB-409-51+

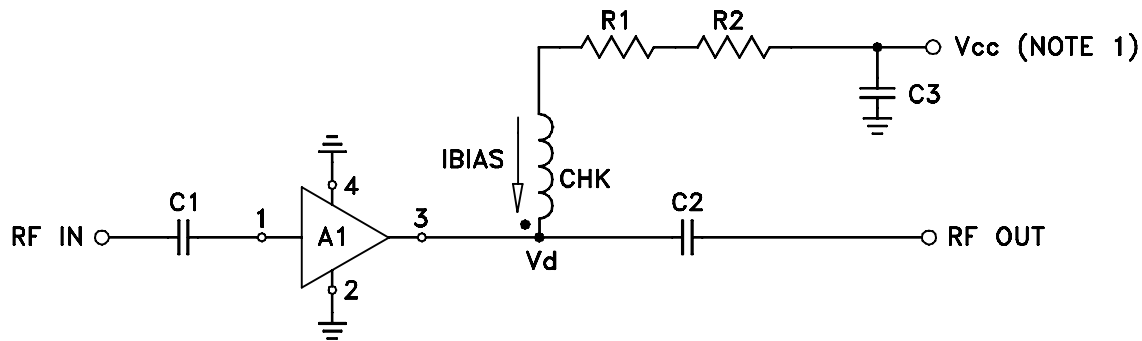

COMPONENT	VALUE
A1	Gali-51(+)
C1 (NOTE 4)	2400 pF
C2 (NOTE 4)	2400 pF
C3 (bypass)	0.1 uF
R1	115 Ohms, 0.75W
R2	0 Ohm, 0.25W
CHK	Mini-Circuits TCCH-80+

Schematic Diagram

NOTE:

1. Vcc voltage: $+12 \pm 0.2V$.
2. SMA Female connectors.
3. PCB material: Rogers R04350 or equivalent, dielectric constant=3.5, dielectric thickness=.030 inch.
4. Capacitors, C1 & C2 should be free of resonance up to the highest frequency specified.

 **Mini-Circuits®**

All Mini-Circuits products are manufactured under exacting quality assurance and control standards, and are capable of meeting published specifications after being subjected to any or all of the following physical and environmental test.

Specification	Test/Inspection Condition	Reference/Spec
Operating Temperature	-45° to 85°C or -40° to 85°C Ambient Environment	Individual Model Data Sheet
Storage Temperature	-65° to 150° C Ambient Environment	Individual Model Data Sheet
Thermal Shock	-55° to 100°C, 100 cycles	MIL-STD-202, Method 107, Condition A-3, except +100°C
Mechanical Shock	1.5Kg, 0.5 ms, 5 shock pulses, Y1 direction only	MIL-STD-883, Method 2002, Condition B, except Y1 direction only
Vibration (Variable Frequency)	50g peak	MIL-STD-883, Method 2007, Condition B
Autoclave	15 psig, 100% RH, 121°C, 96 hours	JESD22-A102, Condition C
HAST	130°C, 85% RH, 96 hours	JESD22-A110
Solderability	10X Magnification	J-STD-002, Para 4.2.5, Test S, 95% Coverage
Solder Reflow Heat	Sn-Pb Eutetic Process: 240°C peak Pb-Free Process: 260°C peak	J-STD-020, Table 4-1, 4-2 and 5-2; Figure 5-1
Moisture Sensitivity: Level 1	Bake at 125°C for 24 hours Soak at 85°C/85% RH for 168 hours, Reflow 3 cycles at 260°C peak	J-STD-020
Marking Resistance to Solvents	Isopropyl alcohol + mineral spirits at 25°C; terpene defluxer at 25°C; distilled water + proylene glycol monomethyl ether +	MIL-STD-202, Method 215



All Mini-Circuits products are manufactured under exacting quality assurance and control standards, and are capable of meeting published specifications after being subjected to any or all of the following physical and environmental test.

Specification	Test/Inspection Condition	Reference/Spec
	monoethanolamine at 63°C to 70°C	