

40GHz Super Low Noise PHEMT

Pseudomorphic High Electron Mobility Transistor

preliminary

Description

The EC2612 is based on a 0.15 μ m gate pseudomorphic high electron mobility transistor (0.15 μ m PHEMT) technology. Gate width is 120 μ m and the 0.15 μ m T-shaped aluminium gate features low resistance and excellent reliability.

The device shows a very high transconductance which leads to very high frequency and low noise performances.

It is available in chip form with sources via holes connection. Only gate and drain wires bounding are required.

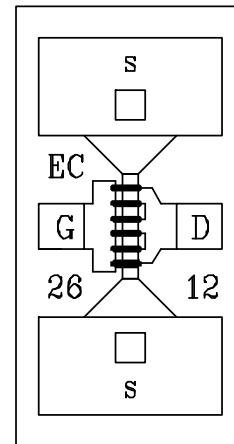

D: Drain
G: Gate
S: Source

Main Features

- | 0.8dB minimum noise figure @ 18GHz
- | 1.5dB minimum noise figure @ 40GHz
- | 12dB associated gain @ 18GHz
- | 9.5dB associated gain @ 40GHz
- | Chip size : 0.63 x 0.37 x 0.1 mm

Main Characteristics

Tamb = +25°C

Symbol	Parameter	Min	Typ	Max	Unit
Idss	Saturated drain current	10	40	60	mA
NFmin	Minimum noise figure (F=40GHz)		1.5	1.9	dB
Ga	Associated gain (F=40GHz)	8	9.5		dB

ESD Protections: Electrostatic discharge sensitive device observe handling precautions!

Electrical Characteristics

Tamb = +25°C

Symbol	Parameter	Test Conditions	Min	Typ	Max	Unit
Idss	Saturated drain current	Vds = 2V Vgs = 0V	10	35	60	mA
Vp	Pinch off voltage	Vds = 2V Ids = 0.1mA	-1.0	-0.7	-0.3	V
Gm	Transconductance	Vds = 2V Ids = 25mA	50	70		mS
Igsd	Gate to source/drain leakage current	Vgsd = -2V			5	µA

Dynamic characteristics

Tamb=25°C

Symbol	Parameter	Test Conditions		Min	Typ.	Max	Unit
NF	Minimum noise figure	Vds=2V Ids=Idss/3	F= 12GHz		0.5	0.7	dB
			F= 30GHz		1.3	1.7	
			F= 40GHz		1.5	1.9	dB
Ga	Associated Gain		F= 12GHz	13	14		dB
			F= 30GHz	9	10		
			F= 40GHz	8	9.5		dB

Absolute Maximum Ratings (1)

Tamb = +25°C

Symbol	Parameter	Values	Units
Vds	Drain to source voltage	3.5	V
Vgs	Gate to source voltage	-2.5	V
Pt	Total power dissipation	280	mW
Tch	Operating channel temperature	+175	°C
Tstg	Storage temperature range	-55 to +175	°C

(1) Operation of this device above any one of these parameters may cause permanent damage

Typical Scattering Parameters

Tamb = +25°C

"S" Parameters, including Lg=Ld~0.15nH

Vds = 3V, Ids = 30mA

Freq. GHz	S11 dB	S11 /°	S12 dB	S12 /°	S21 dB	S21 /°	S22 dB	S22 /°
1	-0,14	-11,0	-34,26	81,5	15,88	169,7	-4,78	-8,8
2	-0,19	-21,6	-28,41	76,1	15,69	162,2	-4,89	-18,3
3	-0,35	-32,3	-25,12	70,0	15,48	154,5	-5,11	-27,2
4	-0,62	-42,5	-22,92	64,0	15,20	146,7	-5,39	-36,0
5	-0,89	-52,5	-21,36	58,1	14,87	139,3	-5,80	-44,4
6	-1,12	-62,2	-20,14	52,2	14,53	132,3	-6,19	-53,5
7	-1,39	-71,9	-19,30	46,4	14,16	125,7	-6,67	-61,5
8	-1,70	-80,5	-18,69	42,0	13,74	119,5	-7,07	-68,5
9	-1,96	-88,2	-18,10	38,0	13,34	113,9	-7,38	-75,6
10	-2,15	-95,9	-17,61	33,5	12,96	108,3	-7,69	-83,2
11	-2,34	-104,1	-17,23	29,4	12,57	103,0	-8,04	-90,1
12	-2,47	-111,8	-16,88	25,8	12,23	97,6	-8,30	-96,9
13	-2,62	-118,7	-16,56	22,1	11,83	92,4	-8,55	-104,7
14	-2,78	-125,5	-16,35	18,7	11,40	87,4	-8,85	-111,9
15	-2,91	-132,8	-16,23	15,4	11,02	82,5	-9,03	-118,3
16	-3,00	-138,8	-16,11	12,9	10,60	78,1	-9,20	-123,8
17	-3,05	-144,2	-15,89	10,0	10,24	73,7	-9,29	-130,8
18	-3,08	-150,1	-15,79	6,7	9,86	69,5	-9,28	-137,3
19	-3,13	-156,5	-15,82	4,1	9,49	65,2	-9,34	-143,2
20	-3,17	-161,6	-15,77	1,5	9,14	61,2	-9,38	-148,9
21	-3,24	-166,5	-15,80	-2,0	8,75	57,2	-9,45	-155,9
22	-3,26	-171,9	-15,90	-4,8	8,40	53,3	-9,47	-160,6
23	-3,30	-176,7	-16,00	-6,9	8,02	50,0	-9,50	-164,8
24	-3,27	179,3	-15,96	-9,8	7,68	46,8	-9,43	-169,2
25	-3,26	175,8	-16,06	-12,6	7,39	43,6	-9,31	-174,6
26	-3,20	172,0	-16,12	-14,9	7,12	40,4	-9,20	-177,9
27	-3,17	167,4	-16,14	-17,2	6,86	37,1	-9,13	177,8
28	-3,15	163,5	-16,16	-20,0	6,62	33,4	-9,06	173,5
29	-3,19	159,2	-16,36	-22,2	6,28	29,7	-8,95	168,4
30	-3,15	155,1	-16,39	-23,1	5,98	26,5	-8,81	166,0
31	-3,10	151,2	-16,29	-24,9	5,70	23,1	-8,67	161,3
32	-3,03	147,7	-16,37	-27,5	5,40	19,5	-8,59	155,5
33	-2,99	144,1	-16,54	-28,8	5,12	16,7	-8,45	152,7
34	-2,98	139,8	-16,62	-30,6	4,89	13,4	-8,38	150,0
35	-2,97	136,5	-16,74	-32,6	4,68	10,1	-8,34	145,6
36	-2,89	132,3	-16,88	-34,5	4,51	6,4	-8,26	141,4
37	-2,85	128,2	-16,84	-36,4	4,24	3,0	-8,10	138,3
38	-2,83	124,9	-16,86	-39,7	4,04	-0,7	-7,89	133,7
39	-2,82	121,6	-17,04	-43,4	3,84	-4,4	-7,77	129,7
40	-2,83	116,9	-17,11	-46,0	3,47	-8,6	-7,71	127,3

Tamb = +25°C

"S" Parameters, including Lg=Ld~0.15nH

Vds = 2V, Ids = 10mA

Freq. GHz	S11 dB	S11 /°	S12 dB	S12 /°	S21 dB	S21 /°	S22 dB	S22 /°
1	-0,11	-10,5	-33,67	82,3	13,52	170,6	-4,76	-7,4
2	-0,26	-20,7	-27,77	77,0	13,38	163,7	-4,81	-16,4
3	-0,45	-29,8	-24,45	71,2	13,22	156,4	-4,99	-24,5
4	-0,66	-38,4	-22,20	65,4	13,01	149,0	-5,21	-32,6
5	-0,85	-47,7	-20,57	59,6	12,74	141,8	-5,56	-40,5
6	-1,03	-56,5	-19,27	53,7	12,48	135,0	-5,88	-49,0
7	-1,20	-65,7	-18,36	47,9	12,19	128,5	-6,29	-56,6
8	-1,41	-73,9	-17,68	43,3	11,85	122,4	-6,65	-63,3
9	-1,64	-81,2	-17,04	39,2	11,51	116,7	-6,91	-70,0
10	-1,85	-88,7	-16,49	34,5	11,19	111,0	-7,19	-77,4
11	-2,04	-96,7	-16,08	30,1	10,85	105,6	-7,53	-84,0
12	-2,19	-104,2	-15,69	26,3	10,56	100,1	-7,78	-90,6
13	-2,35	-111,0	-15,33	22,3	10,22	94,7	-8,03	-98,0
14	-2,51	-117,8	-15,09	18,5	9,82	89,6	-8,34	-105,2
15	-2,66	-125,3	-14,94	14,9	9,49	84,5	-8,49	-111,6
16	-2,78	-131,4	-14,82	12,0	9,12	79,9	-8,67	-117,1
17	-2,86	-136,9	-14,57	8,9	8,78	75,2	-8,82	-124,0
18	-2,92	-142,9	-14,47	5,3	8,43	70,9	-8,91	-130,5
19	-3,00	-149,4	-14,48	2,3	8,08	66,4	-9,02	-136,3
20	-3,08	-154,6	-14,41	-0,5	7,76	62,2	-9,07	-141,9
21	-3,15	-159,8	-14,41	-4,3	7,40	58,0	-9,18	-149,1
22	-3,20	-165,3	-14,50	-7,5	7,07	54,0	-9,27	-154,0
23	-3,23	-170,4	-14,60	-9,8	6,72	50,4	-9,29	-158,4
24	-3,25	-174,7	-14,56	-12,9	6,38	47,1	-9,27	-162,8
25	-3,26	-178,3	-14,65	-16,0	6,10	43,6	-9,22	-168,4
26	-3,27	177,7	-14,71	-18,5	5,83	40,3	-9,16	-171,9
27	-3,27	173,0	-14,72	-21,1	5,57	36,8	-9,08	-176,3
28	-3,26	169,0	-14,74	-24,0	5,34	33,1	-9,05	179,2
29	-3,25	164,6	-14,93	-26,6	5,03	29,3	-8,91	174,0
30	-3,21	160,2	-15,00	-27,9	4,73	26,0	-8,80	171,5
31	-3,18	156,1	-14,93	-30,1	4,47	22,4	-8,67	166,5
32	-3,13	152,5	-15,01	-33,0	4,18	18,6	-8,58	160,6
33	-3,09	148,6	-15,21	-34,6	3,91	15,8	-8,49	157,5
34	-3,07	144,3	-15,27	-36,7	3,69	12,3	-8,39	154,9
35	-3,03	140,9	-15,31	-39,8	3,49	9,0	-8,30	151,3
36	-3,00	136,6	-15,48	-42,0	3,33	5,2	-8,20	146,8
37	-2,98	132,1	-15,49	-44,1	3,07	1,7	-8,08	143,3
38	-2,97	128,6	-15,53	-47,7	2,89	-2,2	-7,95	138,6
39	-2,94	125,3	-15,77	-50,7	2,67	-6,0	-7,86	133,6
40	-2,93	120,6	-15,86	-53,4	2,33	-10,2	-7,78	131,3

Typical results

Tamb = +25°C

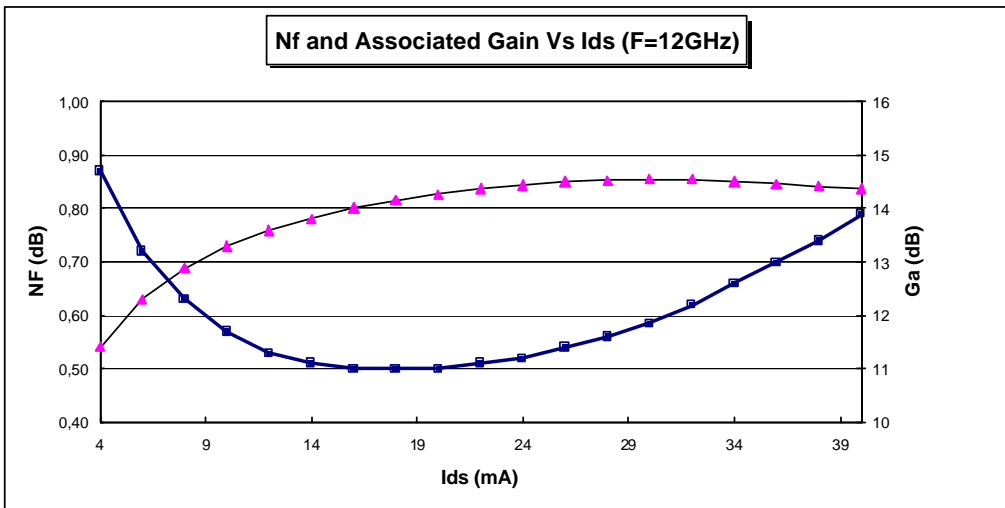
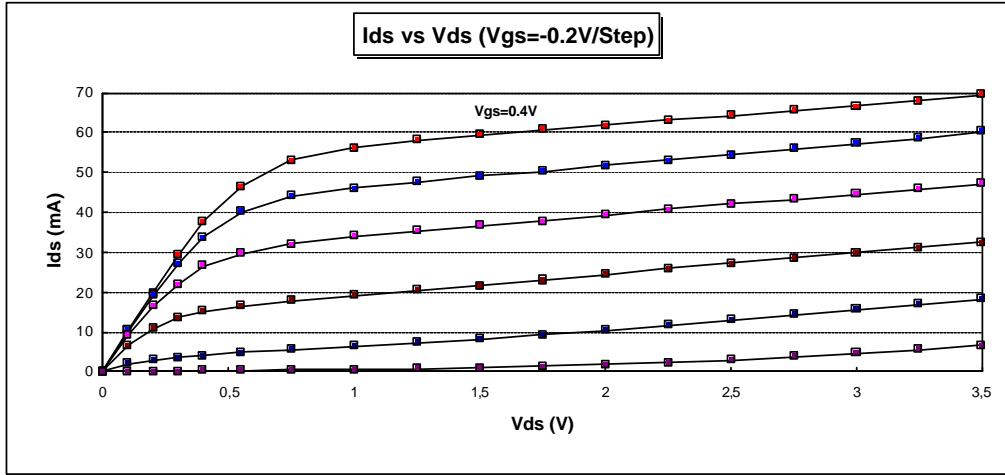

Vds = 2V

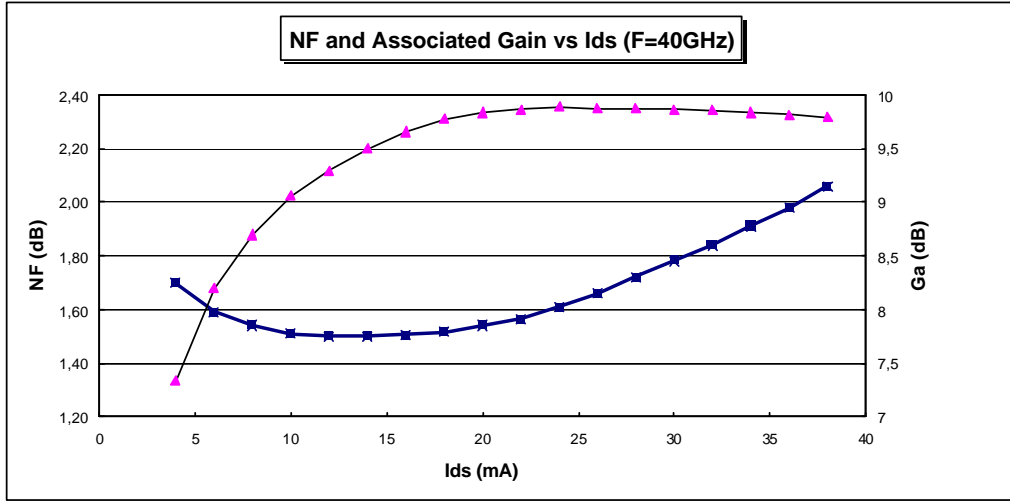

Vds=2V

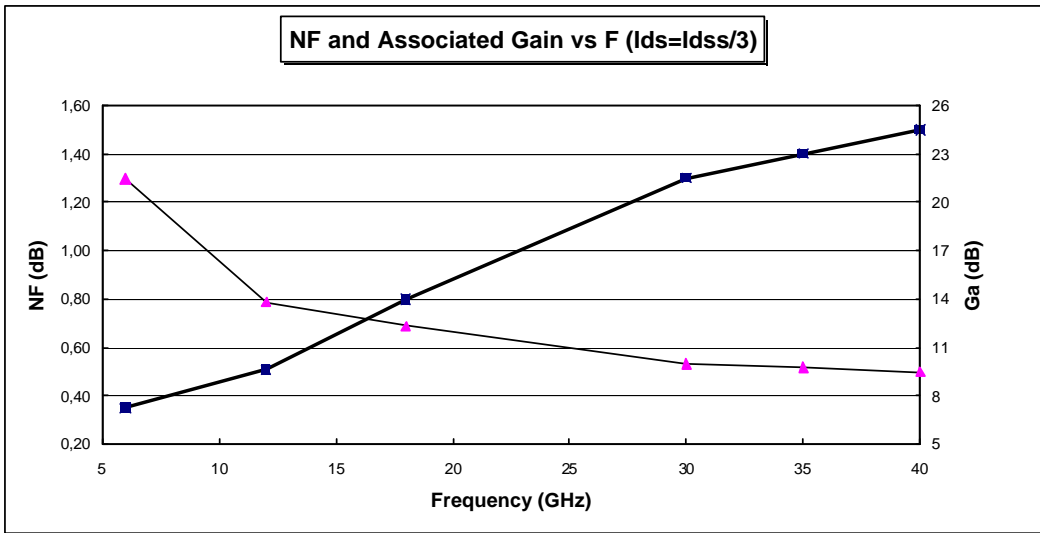

Vds=2V

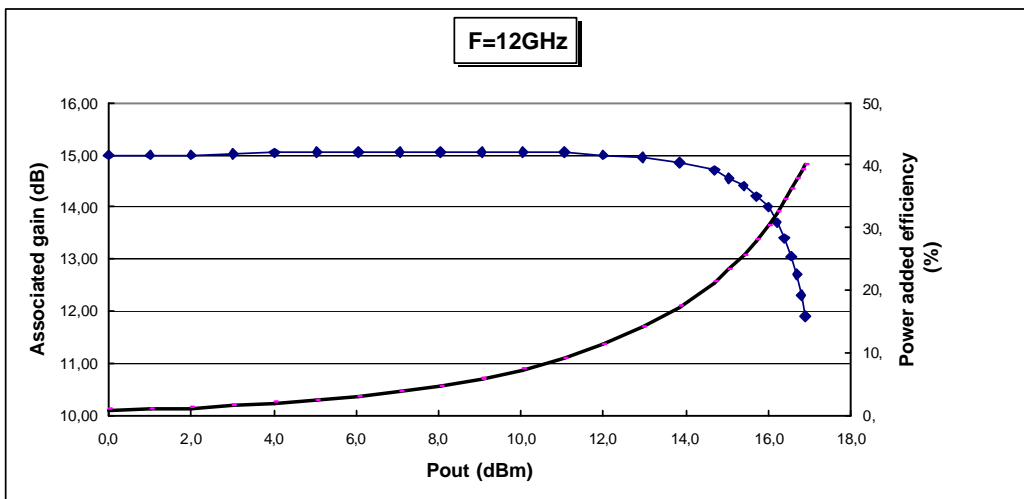

Vds = 3V, Ids = 31mA

(CHIP) Equivalent Circuit model (Drain and Gate bond wires included)

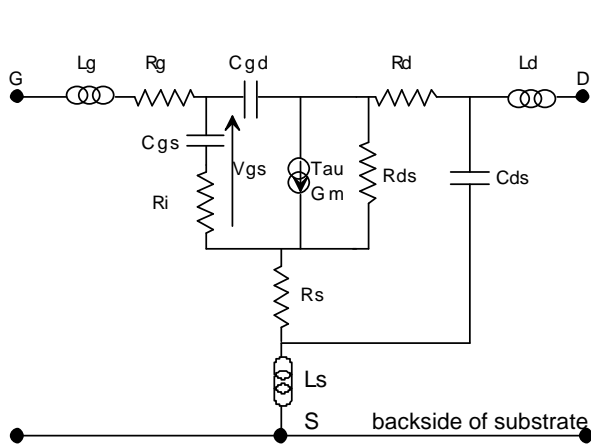

Parameter	Unit	Value
Lg	pH	152.54
Rg	Ohms	0.13
Cgs	fF	142.6
Ri	Ohms	3.2
Cgd	fF	39.57
Rs	Ohms	2.83
Ls	pH	0.11
Gm	mS	98.14
Tau	ps	2.8
Cds	fF	46.84
Rds	Ohms	116.8
Rd	Ohms	2.83
Ld	pH	117.01

Typical Noise Parameters at Vds=2V, Ids=14mA
(Drain and Gate bond wires included)

FREQUENCY MHz	NF min dB	Gopt		Rn
		MOD.	Ang.(°)	
5000	0.26	0.811	19.888	14.089
8000	0.356	0.746	32.28	13.33
12000	0.492	0.658	49.899	11.87
15000	0.595	0.598	64.263	10.51
20000	0.762	0.514	91.037	7.965
24000	0.892	0.473	114.916	5.923
28000	1.01	0.460	139.673	4.16
30000	1.07	0.465	151.723	3.473
32000	1.137	0.475	163.219	2.966
35000	1.223	0.5	179.087	2.63
38000	1.307	0.533	-166.857	2.923
40000	1.362	0.556	-158.467	3.538
42000	1.415	0.581	-150.795	4.536
45000	1.493	0.618	-140.488	6.843

Chip Mechanical Data

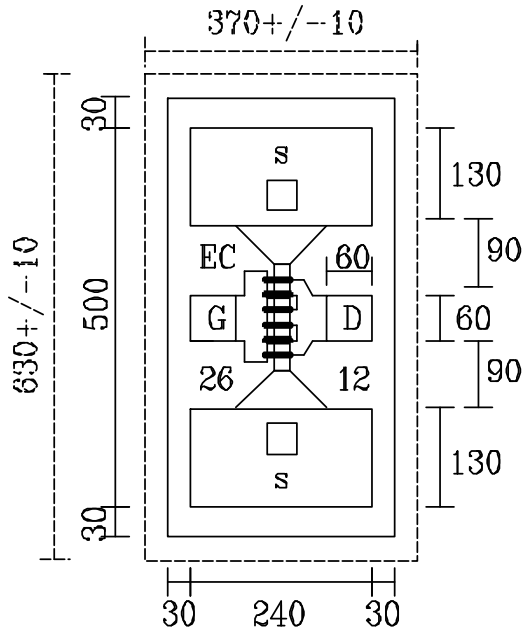

dimensions in μm

Drain area = $60 \times 60 \mu\text{m}$
 Gate area = $60 \times 60 \mu\text{m}$

Thickness = $100 \mu\text{m}$

Recommended die attach :

Stage temperature = 300°C
 (minimize temp. and time whenever possible)

Preforms = Au/Sn (80/20)

Atmosphere : dry nitrogen or forming gas flow

Recommended bonding :

$\varnothing 18 \mu\text{m}$ very pure gold wire
 (thermal compression)

The bonder should be properly grounded

Source pads are directly connected to back face metallization through the via holes

Ordering Information

Chip form : EC2612-99F/00

Information furnished is believed to be accurate and reliable. However **United Monolithic Semiconductors S.A.S.** assumes no responsibility for the consequences of use of such information nor for any infringement of patents or other rights of third parties which may result from its use. No license is granted by implication or otherwise under any patent or patent rights of **United Monolithic Semiconductors S.A.S.**. Specifications mentioned in this publication are subject to change without notice. This publication supersedes and replaces all information previously supplied. **United Monolithic Semiconductors S.A.S.** products are not authorised for use as critical components in life support devices or systems without express written approval from **United Monolithic Semiconductors S.A.S.**