



Product Description

RFMD's SGL0363Z is a low power, low noise amplifier. It is designed for 2.7V to 3.3V battery operation. The matching networks are implemented externally which allows for optimum narrow-band performance with 20dB typical gain and 1.1dB noise figure from 200MHz to 900MHz. This RFIC uses the latest Silicon Germanium HBT process.

Features

- Low Power Consumption, 5.7 mA at 3.3V
- External Input Noise Match
- High Gain and Low Noise, 20dB and 1.1dB respectively at 900 MHz
- Operates from 2.7V to 3.3V
- Power Shutdown Capability using VPC
- 500V ESD, Class 1B
- Small Package: SOT-363
- High input overdrive capability, +18dBm

Applications

- Low Power LNA for ISM, Cellular and Mobile Communications

Optimum Technology Matching® Applied

- GaAs HBT
- GaAs MESFET
- InGaP HBT
- SiGe BiCMOS
- Si BiCMOS
- SiGe HBT
- GaAs pHEMT
- Si CMOS
- Si BJT
- GaN HEMT
- RF MEMS

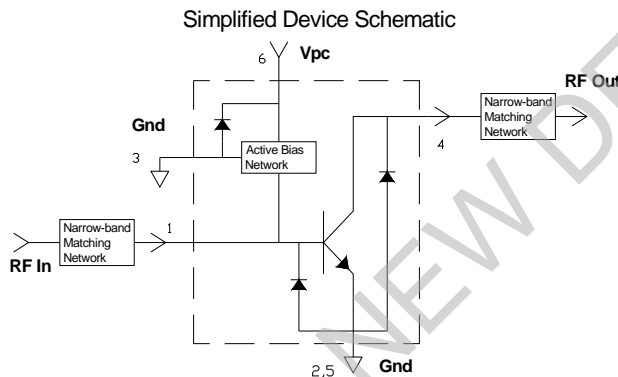

Parameter	Specification			Unit	Condition
	Min.	Typ.	Max.		
Small Signal Gain		21.0		dB	200MHz
	18.0	20.0	22.0	dB	900MHz
	15.0	16.5	18.5	dB	1575MHz
Output Power at 1dB Compression		1.1		dBm	200MHz
		2.5		dBm	900MHz
	1.0	3.5		dBm	1575MHz
Output Third Order Intercept Point		17.2		dBm	200MHz
		12.9		dBm	900MHz
	11.0	14.0		dBm	1575MHz
Input Return Loss		14.0		dBm	200MHz
		15.0		dBm	900MHz
	8.5	10.0		dBm	1575MHz
Output Return Loss		20.0		dBm	200MHz
		12.0		dBm	900MHz
	14.0	20.0		dBm	1575MHz
Noise Figure		1.0		dBm	200MHz
		1.1		dBm	900MHz
		1.5	2.0	dBm	1575MHz
Reverse Isolation		24.0		dBm	200MHz
		27.0		dBm	900MHz
Thermal Resistance		173		°C/W	junction - lead
Device Operating Current	3.5	5.2	7.0	mA	

Test Conditions: V_S=3.3V, I_D=5.2mA Typ., IIP₃ Tone Spacing=1MHz, P_{OUT} per tone=-15dBm, T_L=25°C, Z_S=Z_L=50Ω, Different Application Circuit per Band

Absolute Maximum Ratings

Parameter	Rating	Unit
Device Current (I_D)	20	mA
Device Voltage (V_D)	5.5	V
RF Input Power* (See Note)	18	dBm
Junction Temp (T_J)	+150	°C
Operating Temp Range (T_L)	-40 to +85	°C
Storage Temp	+150	°C
ESD-Rating, Human Body Model (HBM)	1B	Class
Moisture Sensitivity Level	1	MSL



Caution! ESD sensitive device.

Exceeding any one or a combination of the Absolute Maximum Rating conditions may cause permanent damage to the device. Extended application of Absolute Maximum Rating conditions to the device may reduce device reliability. Specified typical performance or functional operation of the device under Absolute Maximum Rating conditions is not implied.

The information in this publication is believed to be accurate and reliable. However, no responsibility is assumed by RF Micro Devices, Inc. ("RFMD") for its use, nor for any infringement of patents, or other rights of third parties, resulting from its use. No license is granted by implication or otherwise under any patent or patent rights of RFMD. RFMD reserves the right to change component circuitry, recommended application circuitry and specifications at any time without prior notice.



RFMD Green: RoHS compliant per EU Directive 2002/95/EC, halogen free per IEC 61249-2-21, < 1000ppm each of antimony trioxide in polymeric materials and red phosphorus as a flame retardant, and <2% antimony in solder.

*Note: Load condition1, $Z_L = 50\Omega$. Load condition2, $Z_L = 10:1$ VSWR.

Operation of this device beyond any one of these limits may cause permanent damage. For reliable continuous operation, the device voltage and current must not exceed the maximum operating values specified in the table on page one.

Bias Conditions should also satisfy the following expression:

$$I_D V_D < (T_J - T_L) / R_{TH} + j-I \text{ and } T_L = T_{LEAD}$$

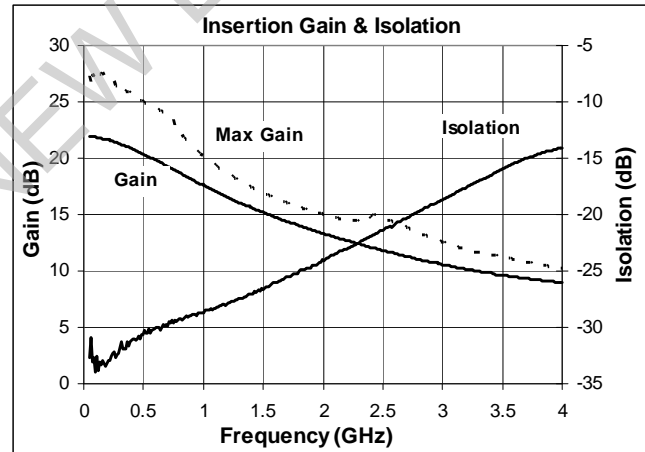
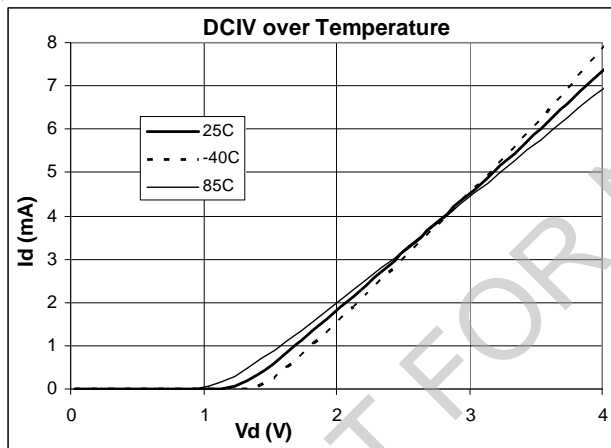

NOT FOR NEW DESIGN

200MHz Application Circuit Data, $V_S=3.3V$, $I_D=5.2mA$

Note: Tuned for NF

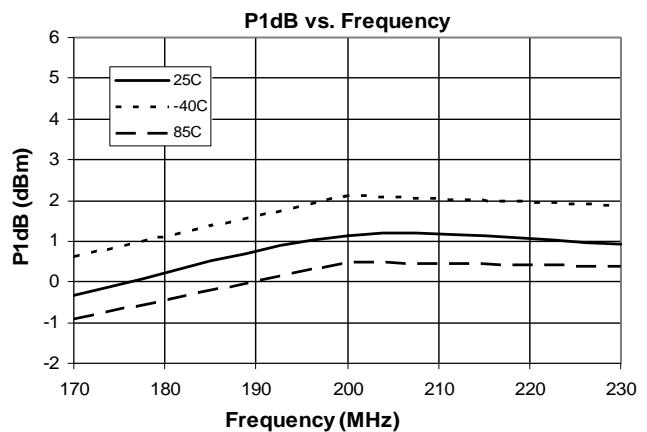
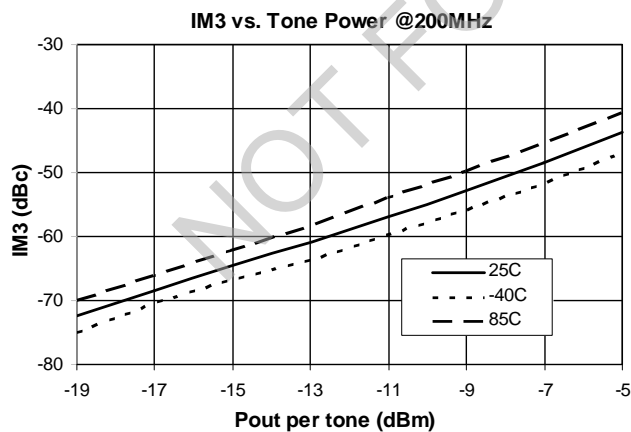
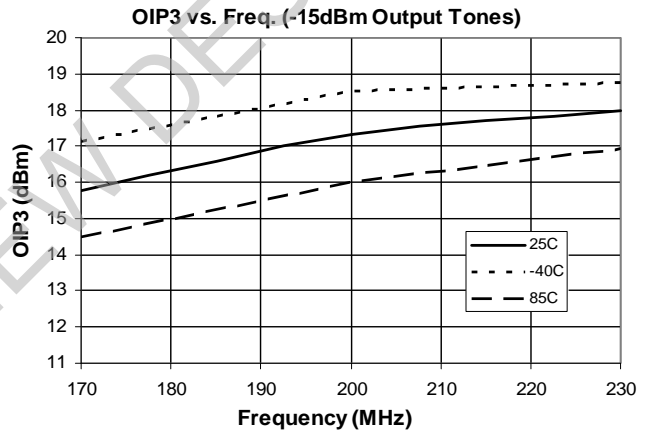
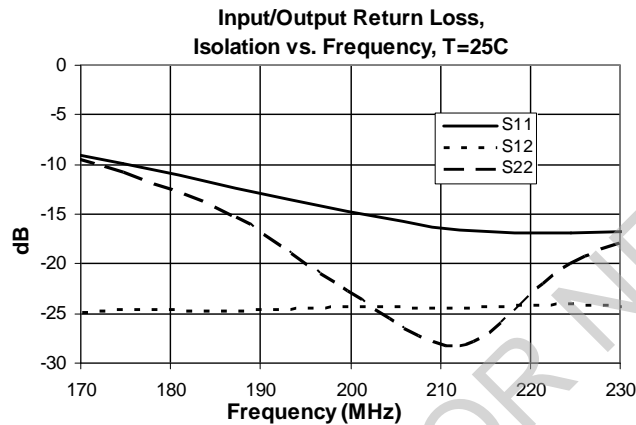
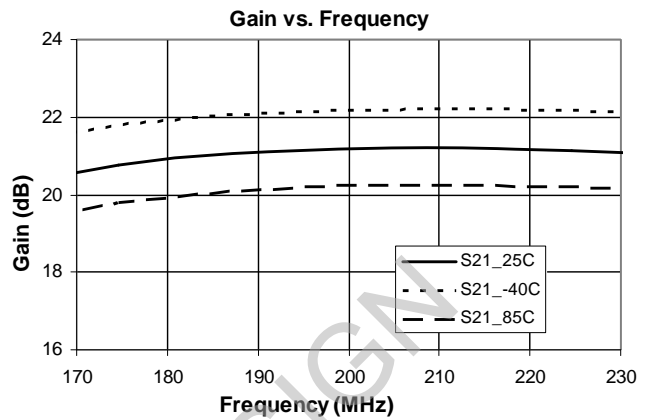
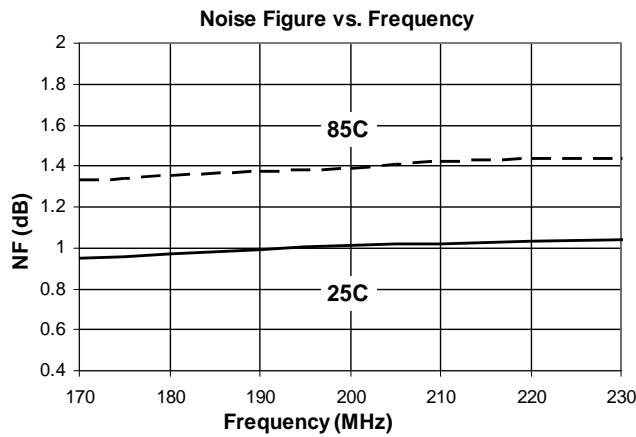

450MHz Application Circuit Data, $V_S=3.3V$, $I_D=5.2mA$.

Note: Tuned for NF

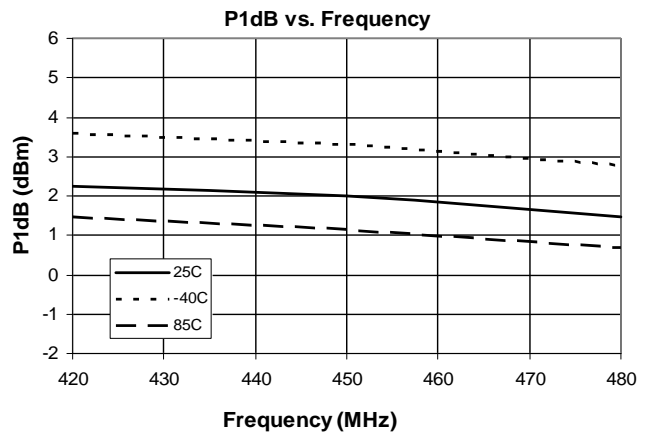
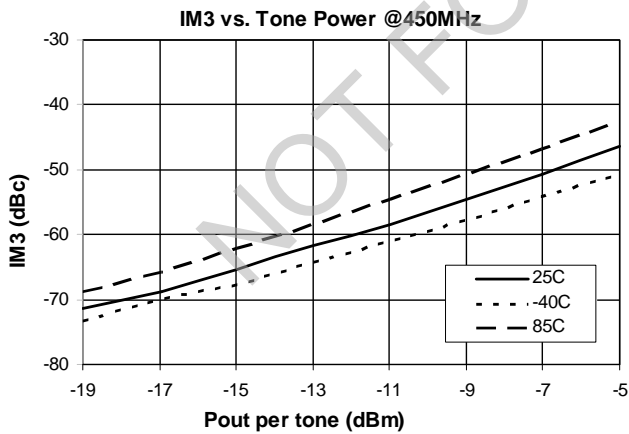
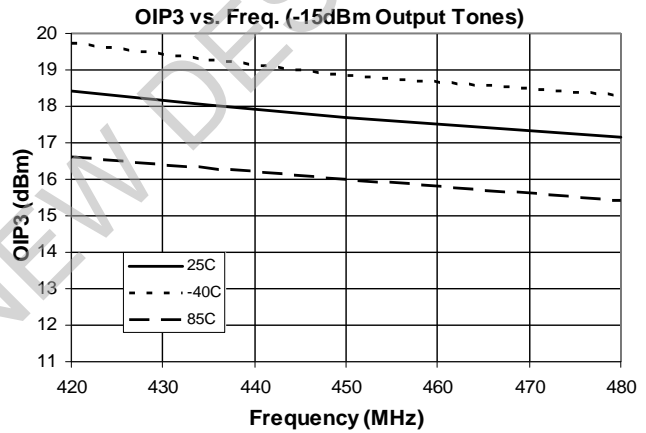
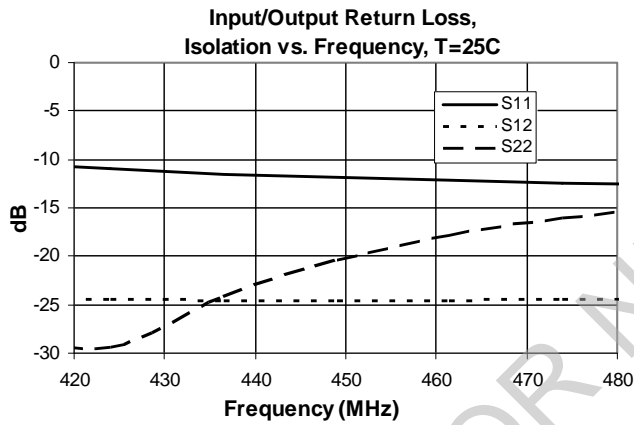
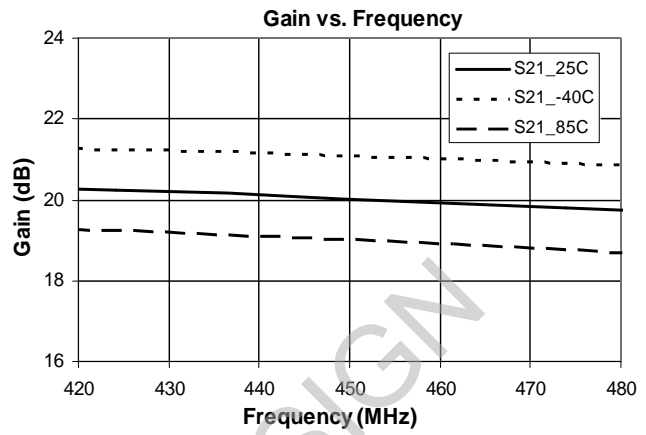
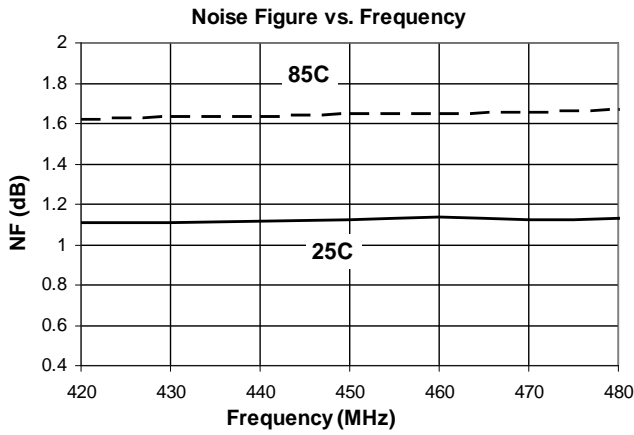

900MHz Application Circuit Data, $V_S=3.3V$, $I_D=5.2mA$

Note: Tuned for NF

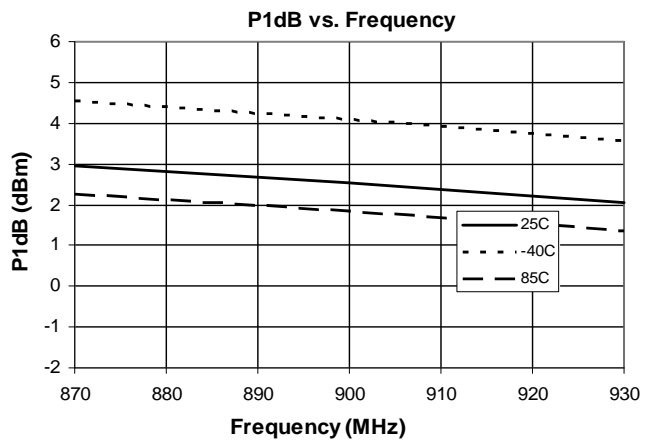
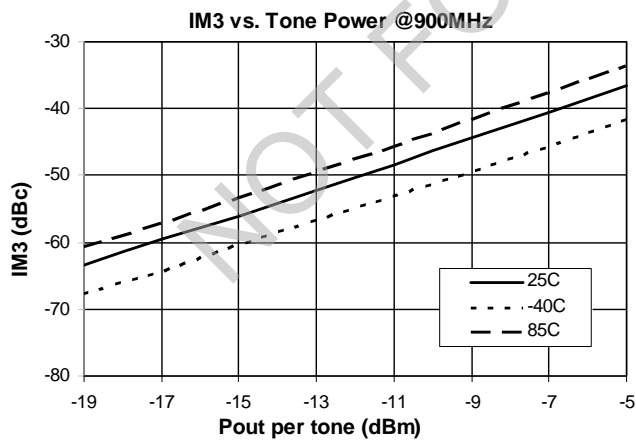
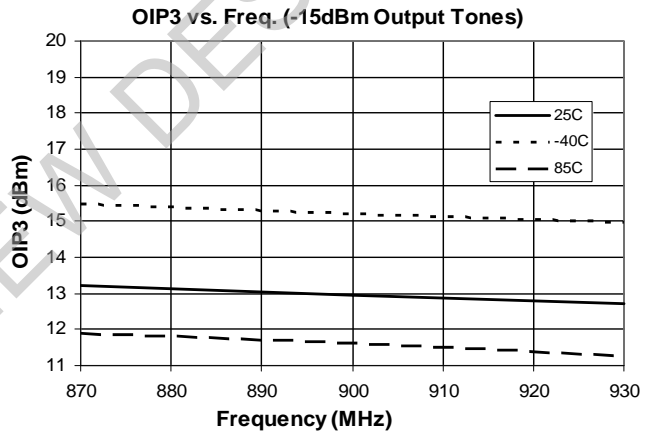
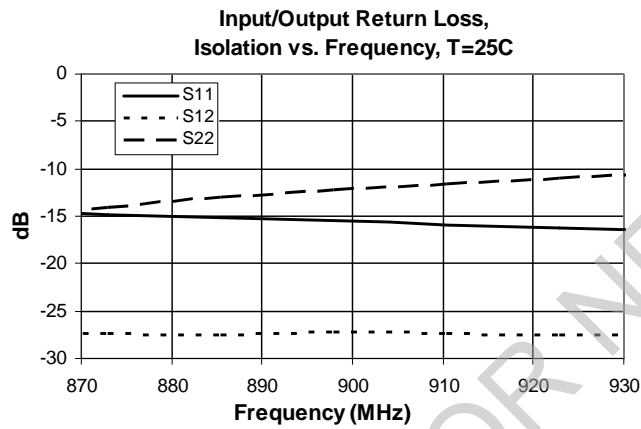
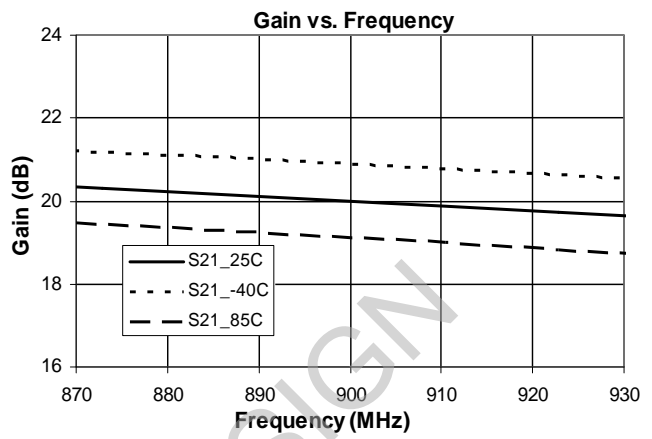
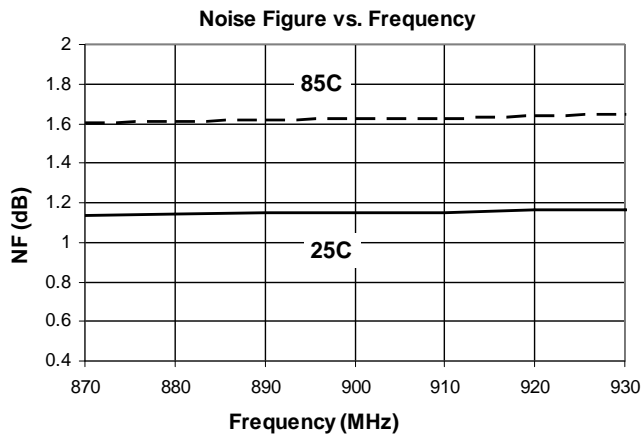

Typical Performance - De-embedded S-parameters

S11 Vs. Frequency

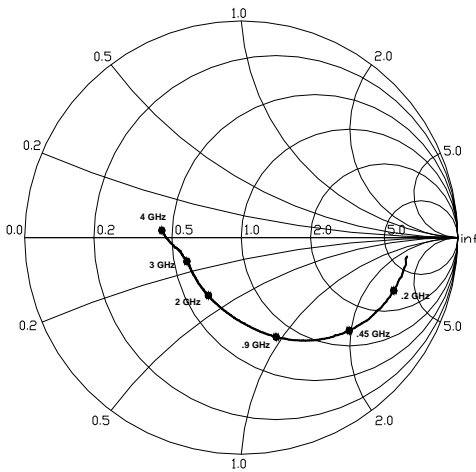

S22 Vs. Frequency

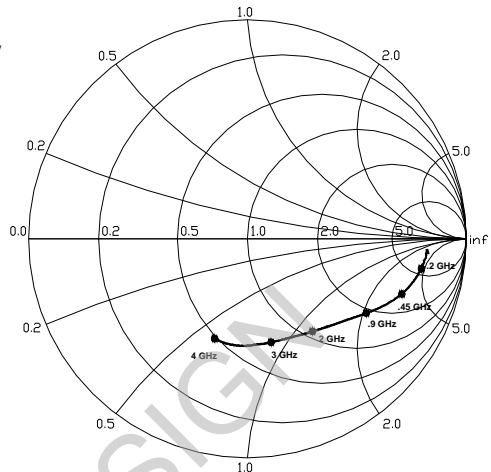

Note:

S-parameters are de-embedded to the device leads with $Z_S = Z_L = 50\Omega$. De-embedded S-parameters can be downloaded from our website (www.rfmd.com)

NOT FOR NEW DESIGN

Pin	Function	Description
1	RF IN	RF input pin. This pin requires the use of an external DC blocking capacitor and matching components as shown in the application schematics.
2, 5	GND	Connect to ground per application circuit drawing. Series feedback used to improve IRL.
3	GND	Ground active bias tied internally to pin 2 and 5.
4	RF OUT/VD	RF output and bias pin. Bias should be supplied to this pin through an external RF choke.
6	VPC	V _{PC} is the bias control pin for the active bias network.

Suggested Pad Layout

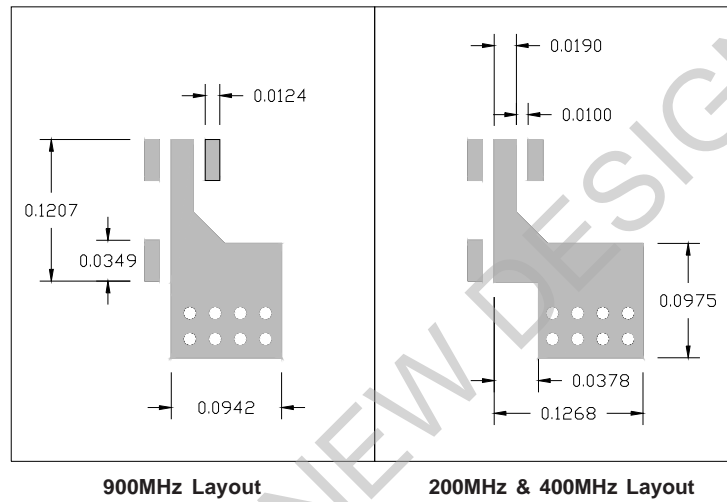

Nominal Package Dimensions

Dimensions in inches (millimeters)
Refer to drawing posted at www.rfmd.com for tolerances.

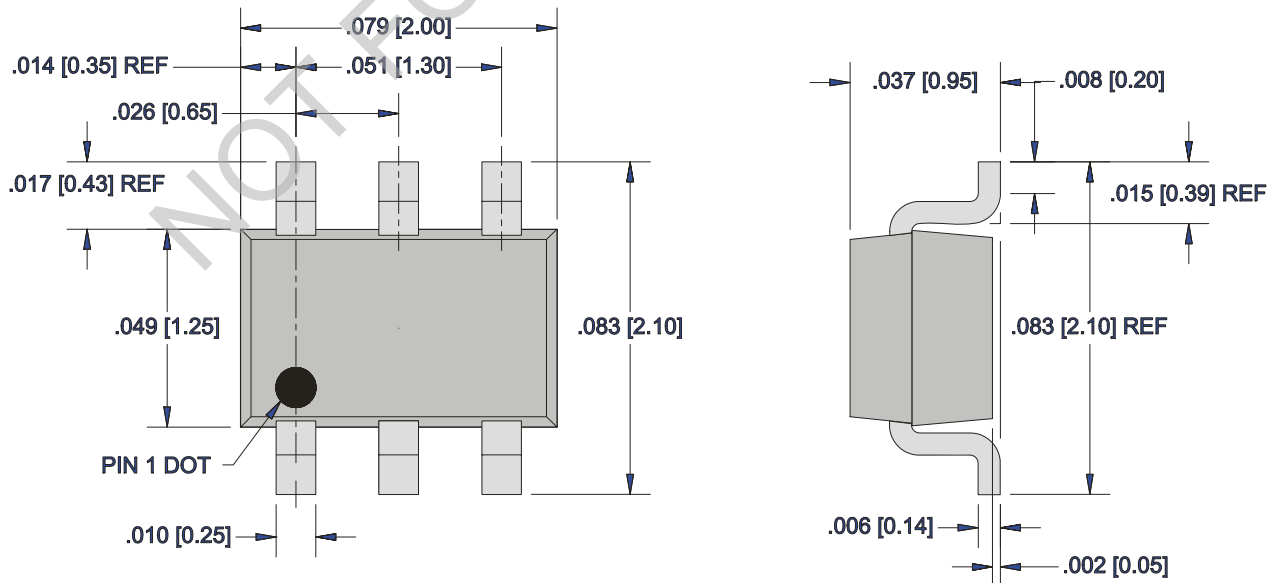

Application Schematic for 450MHz

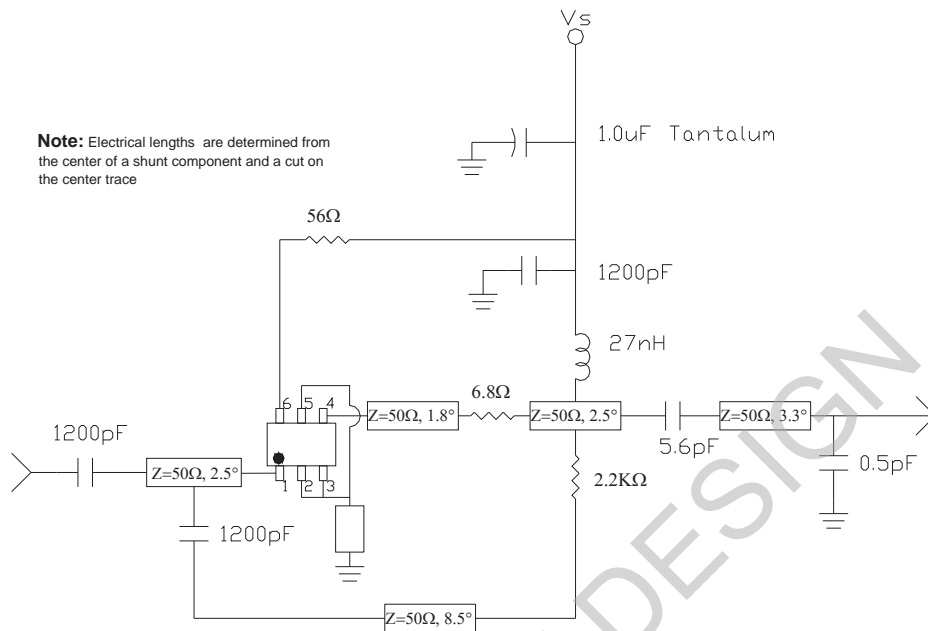

Evaluation Board Layout and Bill of Materials for 450MHz

Bill of Materials

- C1 1.0uF Tantalum capacitor
- C2 1200pF ceramic 0603 capacitor
- C3 5.6pF ceramic 0603 capacitor
- C4 1200pF ceramic 0603 capacitor
- C5 1200pF ceramic 0603 capacitor
- C6 0.5pF ceramic 0603 capacitor
- L1 LL1608-FS27NJ Toko 27nH
- R1 2.2KΩ 0603 res (5%)
- R2 56Ω 0603 res (5%)
- R3 6.8Ω 0603 res (5%)

Connectors 2x PSF-S01-1mm GigaLane Co.
 Heat sink EEF-102059
 PCB 125390-B

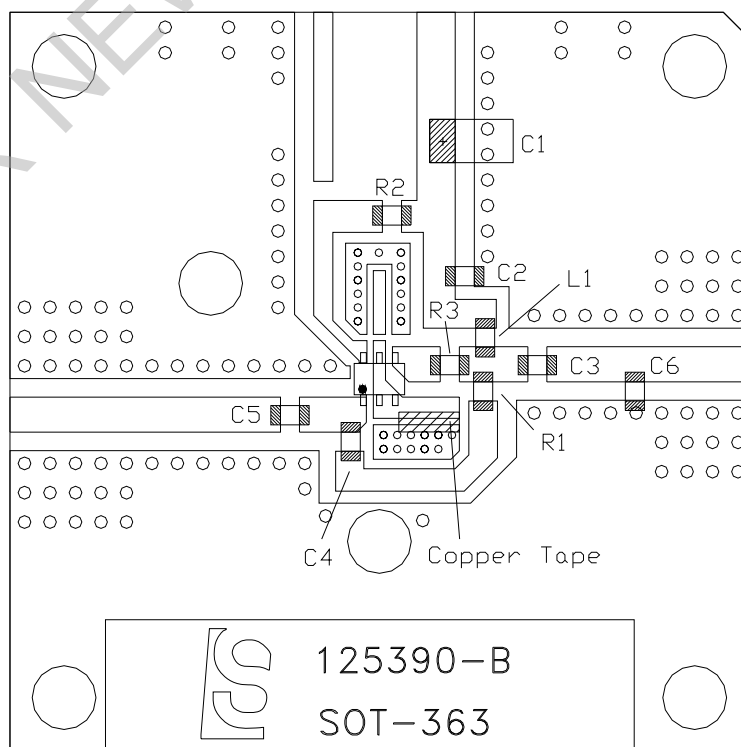

Application Schematic for 900 MHz

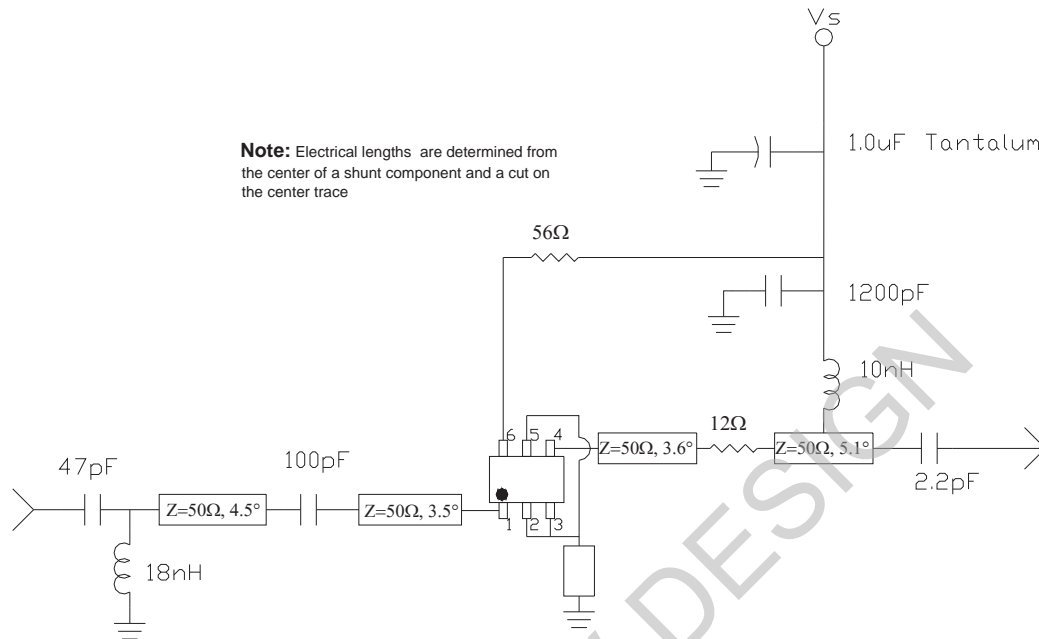

Evaluation Board Layout and Bill of Materials for 900MHz

Bill of Materials

- C1 1.0uF Tantalum capacitor
 - C2 1200pF ceramic 0603 capacitor
 - C3 2.2pF ceramic 0603 capacitor
 - C4 100pF ceramic 0603 capacitor
 - C5 47pF ceramic 0603 capacitor
 - L1 LL1608-FS10NJ Toko 10nH
 - L2 LL1608-FS18NJ Toko 18nH
 - R1 12Ω 0603 res (5%)
 - R2 56Ω 0603 res (5%)
- Connectors 2x PSF-S01-1mm GigaLane Co.
 Heat sink EEF-102059
 PCB 125390-B

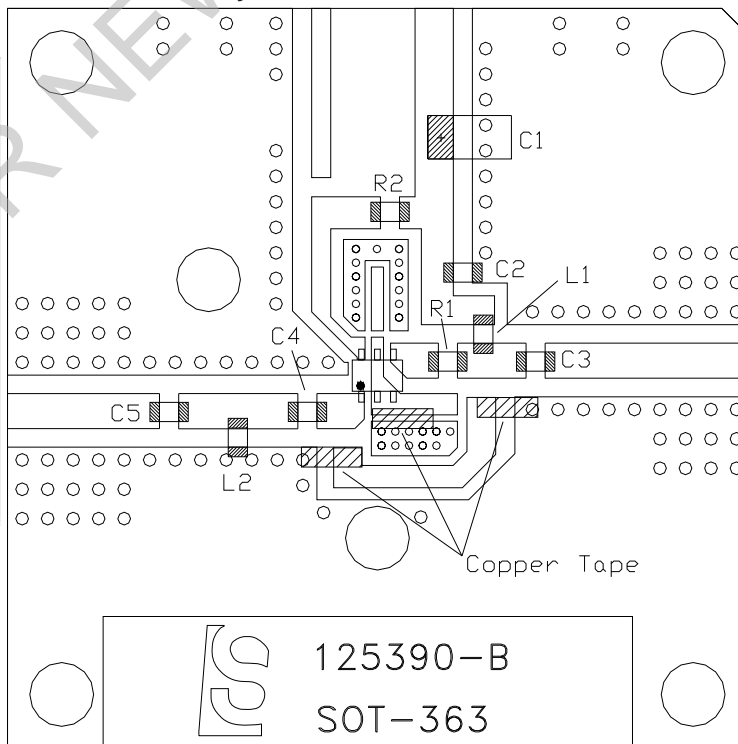

Part Identification Marking

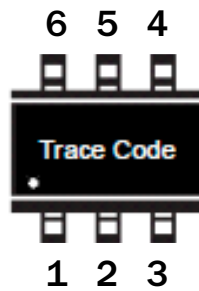

Ordering Information

Part Number	Description
SGL0363Z	7" Reel with 3000 pieces
SGL0363ZSQ	Sample Bag with 25 pieces
SGL0363ZSR	7" Reel with 100 pieces
SGL0363ZPCK1	170MHz to 230MHz PCBA with 5-piece Sample Bag
SGL0363ZPCK2	420MHz to 480MHz PCBA with 5-piece Sample Bag
SGL0363ZPCK3	870MHz to 930MHz PCBA with 5-piece Sample Bag
SGL0363ZPCK4	1540MHz to 1600MHz PCBA with 5-piece Sample Bag

NOT FOR NEW DESIGN