

CG2H40010

10 W, DC - 8 GHz, RF Power GaN HEMT

Description

Cree's CG2H40010 is an unmatched, gallium nitride (GaN) high electron mobility transistor (HEMT). The CG2H40010, operating from a 28 volt rail, offers a general purpose, broadband solution to a variety of RF and microwave applications. GaN HEMTs offer high efficiency, high gain and wide bandwidth capabilities making the CG2H40010 ideal for linear and compressed amplifier circuits. The transistor is available in both screw-down, flange and solderdown, pill packages.

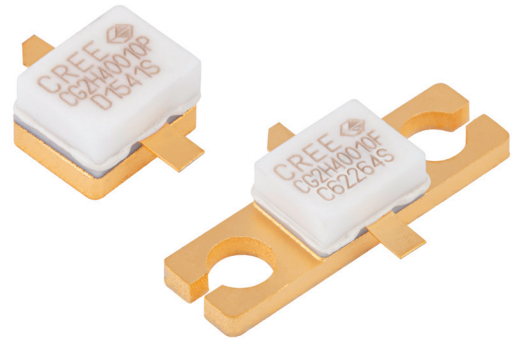

Package Types: 440196, & 440166
PNs: CG2H40010P & CG2H40010F

Features

- Up to 8 GHz Operation
- 18 dB Small Signal Gain at 2.0 GHz
- 16 dB Small Signal Gain at 4.0 GHz
- 17 W typical P_{SAT}
- 70% Efficiency at P_{SAT}
- 28 V Operation

Applications

- 2-Way Private Radio
- Broadband Amplifiers
- Cellular Infrastructure
- Test Instrumentation
- Class A, AB, Linear amplifiers suitable for OFDM, W-CDMA, EDGE, CDMA waveforms

 Large Signal Models Available for ADS and MWO

RoHS
COMPLIANT

Absolute Maximum Ratings (not simultaneous) at 25 °C Case Temperature

Parameter	Symbol	Rating	Units	Conditions
Drain-Source Voltage	V_{DS}	120	Volts	25 °C
Gate-to-Source Voltage	V_{GS}	-10, +2	Volts	25 °C
Storage Temperature	T_{STG}	-65, +150	°C	
Operating Junction Temperature	T_J	225	°C	
Maximum Forward Gate Current	I_{GMAX}	4.0	mA	25 °C
Maximum Drain Current ¹	I_{DMAX}	1.5	A	25 °C
Soldering Temperature ²	T_S	245	°C	
Screw Torque	τ	40	in-oz	
Thermal Resistance, Junction to Case ³	$R_{\theta JC}$	7.83	°C/W	85 °C
Case Operating Temperature ^{3,4}	T_C	-40, +150	°C	

Notes:

¹ Current limit for long term, reliable operation

² Refer to the Application Note on soldering at wolfspeed.com/RF/Document-Library

³ Measured for the CG2H40010F at $P_{DISS} = 14 W$

⁴ See also, the Power Dissipation De-rating Curve on Page 6

Electrical Characteristics ($T_c = 25^\circ C$)

Characteristics	Symbol	Min.	Typ.	Max.	Units	Conditions
DC Characteristics¹						
Gate Threshold Voltage	$V_{GS(th)}$	-3.6	-3.0	-2.4	V_{DC}	$V_{DS} = 10 V, I_D = 3.6 mA$
Gate Quiescent Voltage	$V_{GS(Q)}$	-	-2.7	-	V_{DC}	$V_{DS} = 28 V, I_D = 200 mA$
Saturated Drain Current	I_{DS}	2.59	3.6	-	A	$V_{DS} = 6.0 V, V_{GS} = 2.0 V$
Drain-Source Breakdown Voltage	V_{BR}	84	-	-	V_{DC}	$V_{GS} = -8 V, I_D = 3.6 mA$
RF Characteristics² ($T_c = 25^\circ C, F_0 = 3.7 GHz$ unless otherwise noted)						
Small Signal Gain	G_{SS}	15.0	16.7	-	dB	$V_{DD} = 28 V, I_{DQ} = 200 mA$
Output Power ³	P_{SAT}	11.0	16.5	-	w	$V_{DD} = 28 V, I_{DQ} = 200 mA$
Drain Efficiency ⁴	η	60	70	-	%	$V_{DD} = 28 V, I_{DQ} = 200 mA, P_{SAT}$
Output Mismatch Stress	VSWR	-	-	10 : 1	Ψ	No damage at all phase angles, $V_{DD} = 28 V, I_{DQ} = 200 mA, P_{OUT} = 10 W CW$
Dynamic Characteristics						
Input Capacitance	C_{GS}	-	4.19	-	pF	$V_{DS} = 28 V, V_{GS} = -8 V, f = 1 MHz$
Output Capacitance	C_{DS}	-	1.84	-	pF	$V_{DS} = 28 V, V_{GS} = -8 V, f = 1 MHz$
Feedback Capacitance	C_{GD}	-	0.186	-	pF	$V_{DS} = 28 V, V_{GS} = -8 V, f = 1 MHz$

Notes:

¹ Measured on wafer prior to packaging

² Measured in CG2H40010-AMP

³ P_{SAT} is defined as $I_G = 0.36 mA$

⁴ Drain Efficiency = P_{OUT} / P_{DC}



Typical Performance

Figure 1. Small Signal Gain and Return Loss vs Frequency of the CG2H40010 in the CG2H40010-AMP
 $V_{DD} = 28\text{ V}, I_{DQ} = 100\text{ mA}$

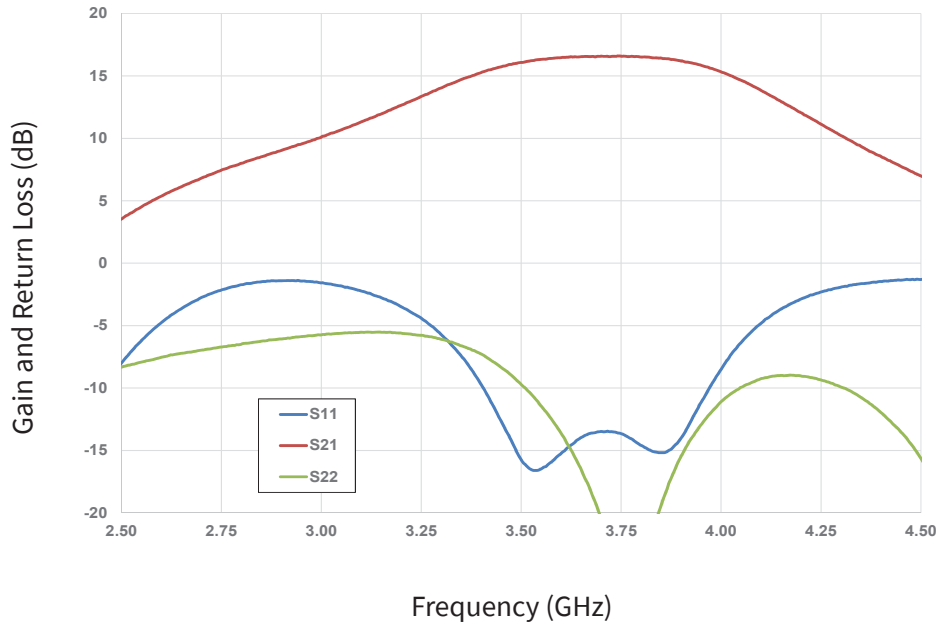
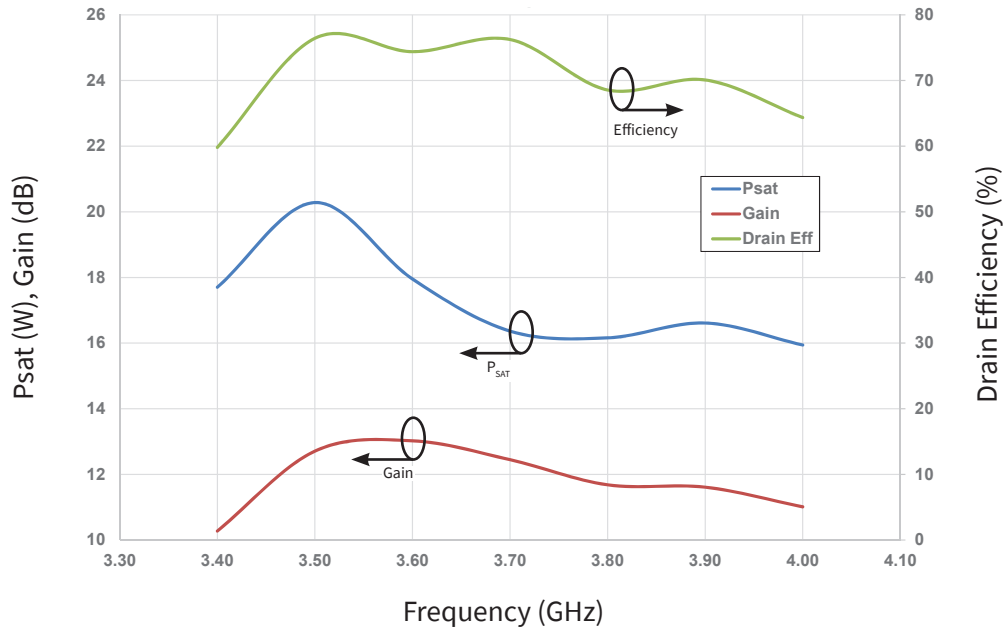

Figure 2. P_{SAT} , Gain, and Drain Efficiency vs Frequency of the CG2H40010F in the CG2H40010-AMP
 $V_{DD} = 28\text{ V}, I_{DQ} = 100\text{ mA}$





Typical Performance

Figure 3. Swept CW Data of CG2H40010F vs. Output Power
Measured in CG2H40010-AMP at 3.7 GHz
 $V_{DD} = 28\text{ V}, I_{DQ} = 100\text{ mA}$

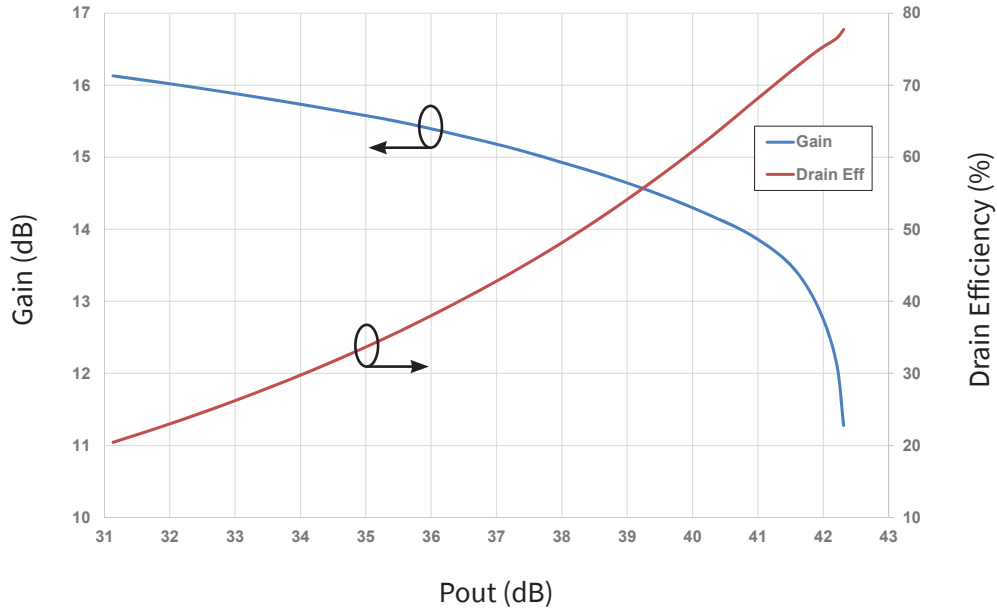
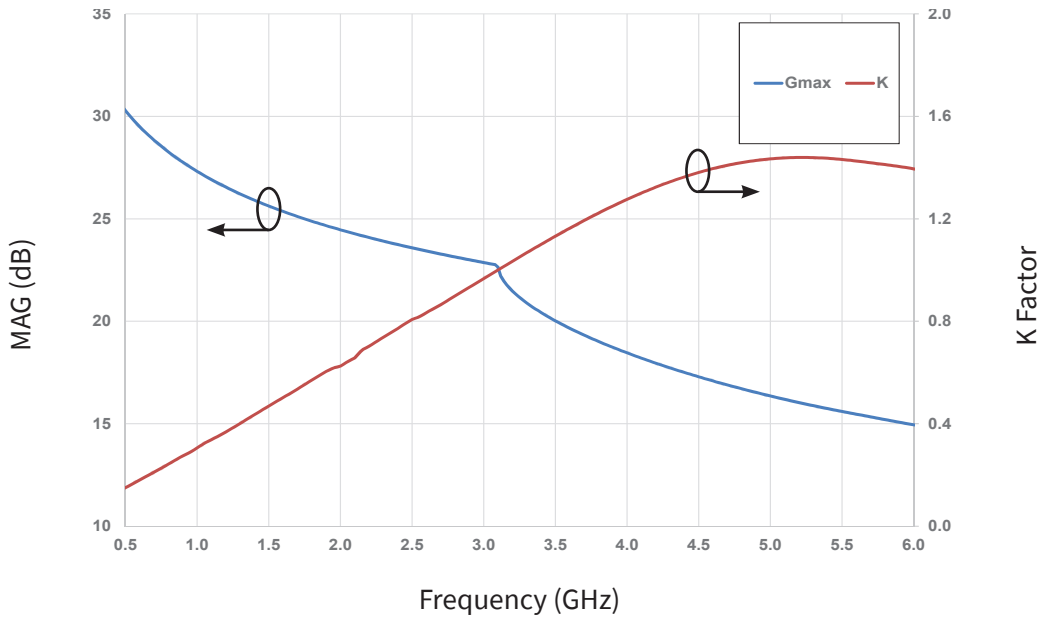

Figure 4. Simulated Maximum Available Gain and K Factor of CG2H40010F
 $V_{DD} = 28\text{ V}, I_{DQ} = 100\text{ mA}$





Typical Noise Performance

Figure 5. Simulated Minimum Noise Figure and Noise Resistance vs Frequency of the CG2H40010F
 $V_{DD} = 28\text{ V}, I_{DQ} = 100\text{ mA}$

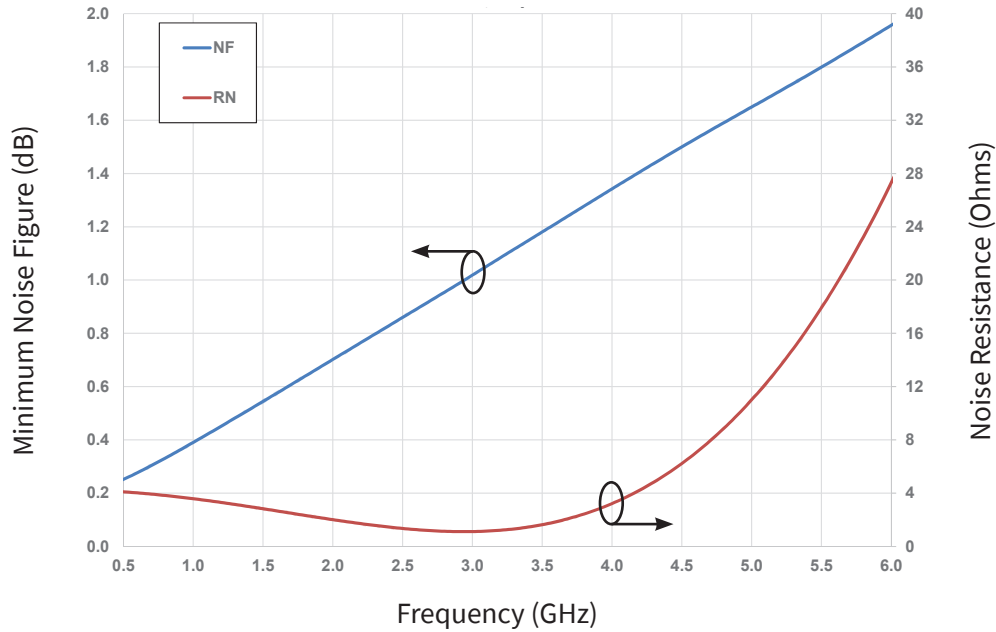

Electrostatic Discharge (ESD) Classifications

Parameter	Symbol	Class	Test Methodology
Human Body Model	HBM	1A (> 250 V)	JEDEC JESD22 A114-D
Charge Device Model	CDM	II (200 < 500 V)	JEDEC JESD22 C101-C

Source and Load Impedances

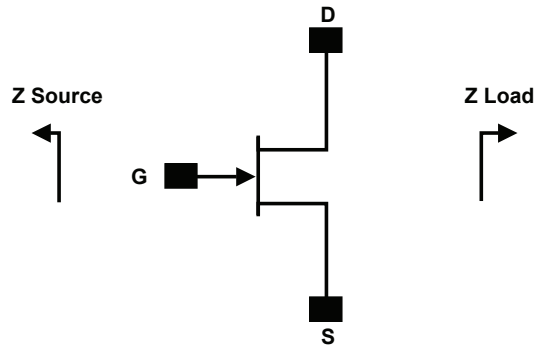

Frequency (MHz)	Z Source	Z Load
0.50	55.3 + j27.6	40.9 + j2.34
1.00	30.9 + j17.8	26 + j7.7
1.50	20.4 + j5.17	27 + j6.5
2.00	16.7 + j0.60	18.3 + j5.94
2.50	9.7 - j4.6	11.5 + j10.9
3.00	6.6 - j7.75	20.6 + j8.75
3.50	5.1 - j11.5	15.2 + j3.43
4.00	6.21 - j14.1	11.6 - j4.77
4.50	4.89 - j19.8	8.58 - j5.11
5.00	5.22 - j25.9	10.8 - j6.23
5.50	5.77 - j30.8	9.06 - j13.3
6.00	8.04 - j37.2	10.2 - j15.3

Note¹. $V_{DD} = 28V, I_{DD} = 100\text{ mA}$ in the 440166 package

Note². Optimized for power, gain, P_{SAT} and PAE

Note³. When using this device at low frequency, series resistors should be used to maintain amplifier stability

CG2H40010 Power Dissipation De-rating Curve

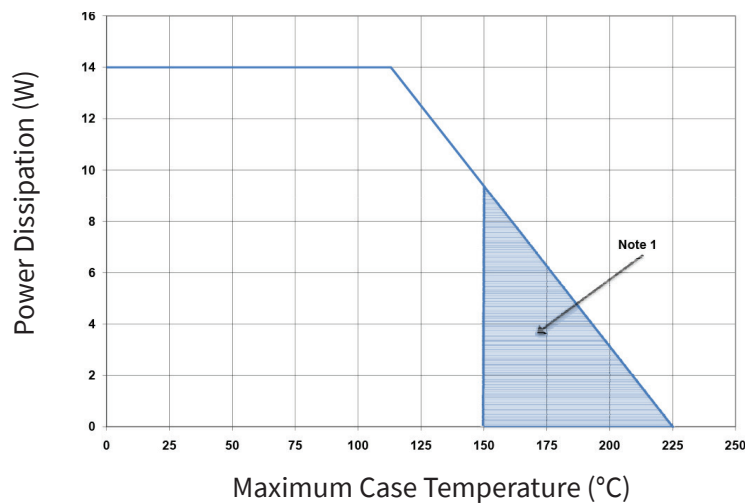

Note 1. Area exceeds Maximum Case Operating Temperature (See Page 2)

CG2H40010-AMP Demonstration Amplifier Circuit Bill of Materials

Designator	Description	Qty
R1, R2	RES,1/16W,0603,1%,0 OHMS	1
R3	RES,1/16W,0603,1%,47 OHMS	1
R4	RES,1/16W,0603,1%,100 OHMS	1
C6	CAP, 470pF, 5%, 100V, 0603, X7R, ROHS COMPLIANT	1
C17	CAP, 33 UF, 20%, G CASE	1
C16	CAP, 1.0UF, 100V, 10%, X7R, 1210	1
C8	CAP 10UF 16V TANTALUM	1
C14	CAP, 100.0pF, +/-5%, 0603	1
C1	CAP, 0.5pF, +/-0.05pF, 0603	1
C2	CAP, 0.7pF, +/-0.1pF, 0603	1
C10, C11	CAP, 1.0pF, +/-0.1pF, 0603	2
C4, C12	CAP, 10.0pF,+/-5%, 0603	2
C5, C13	CAP, 39pF, +/-5%, 0603	2
C7, C15	CAP,33000PF, 0805,100V, X7R	2
J3, J4	CONN SMA STR PANEL JACK RECP	1
J2	HEADER RT>PLZ.1CEN LK 2 POS	1
J1	HEADER RT>PLZ .1CEN LK 5POS	1
-	PCB, RO4350B, Er = 3.48, h = 20 mil	1
Q1	CG2H40010F or CG2H40010P	1



CG2H40010-AMP Demonstration Amplifier Circuit Schematic

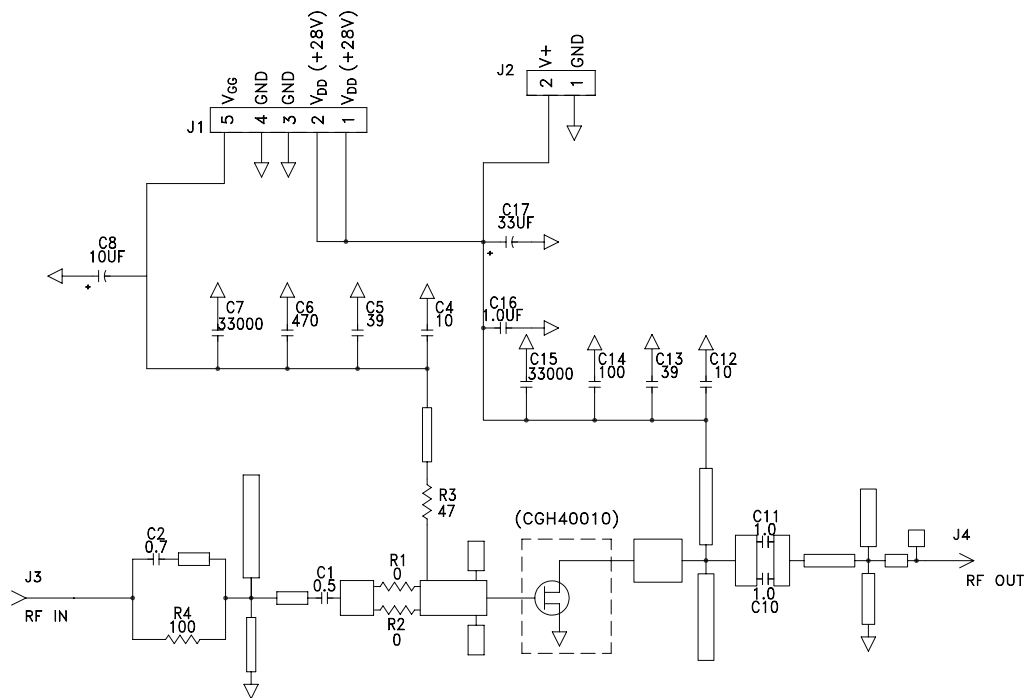

CG2H40010-AMP Demonstration Amplifier Circuit Outline

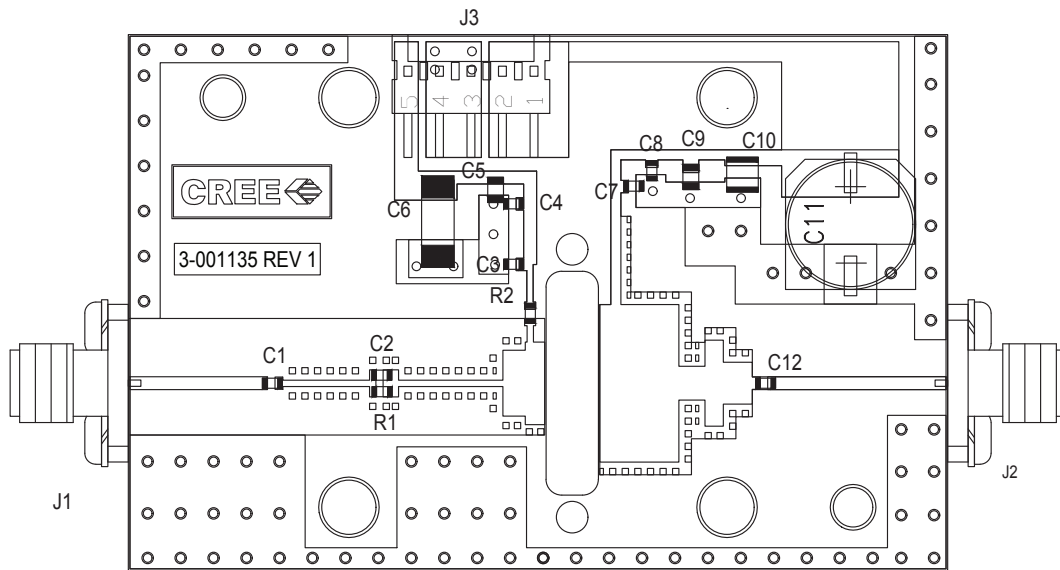



Typical Package S-Parameters for CG2H40010
 (Small Signal, $V_{DS} = 28\text{ V}$, $I_{DQ} = 100\text{ mA}$, angle in degrees)

Frequency	Mag S11	Ang S11	Mag S21	Ang S21	Mag S12	Ang S12	Mag S22	Ang S22
0.50	0.872	-116.75	21.365	110.57	0.0279	24.89	0.417	-103.52
0.60	0.860	-126.97	18.584	103.99	0.0290	19.19	0.407	-112.55
0.70	0.851	-135.13	16.376	98.45	0.0298	14.53	0.401	-119.61
0.80	0.845	-141.80	14.600	93.64	0.0302	10.60	0.398	-125.24
0.90	0.841	-147.38	13.151	89.35	0.0306	7.22	0.397	-129.81
1.00	0.837	-152.15	11.950	85.47	0.0307	4.24	0.398	-133.60
1.10	0.835	-156.31	10.942	81.88	0.0308	1.56	0.399	-136.79
1.20	0.833	-159.98	10.086	78.52	0.0309	-0.87	0.402	-139.53
1.30	0.831	-163.28	9.350	75.34	0.0309	-3.10	0.405	-141.92
1.40	0.830	-166.28	8.712	72.32	0.0308	-5.17	0.409	-144.05
1.50	0.829	-169.04	8.155	69.41	0.0307	-7.11	0.413	-145.96
1.60	0.829	-171.60	7.663	66.61	0.0306	-8.93	0.417	-147.72
1.70	0.828	-174.01	7.227	63.89	0.0305	-10.65	0.422	-149.34
1.80	0.828	-176.27	6.838	61.24	0.0304	-12.28	0.427	-150.87
1.90	0.827	-178.43	6.488	58.65	0.0302	-13.82	0.432	-152.32
2.00	0.827	-179.50	6.173	56.11	0.0300	-15.29	0.437	-153.71
2.10	0.827	-177.51	5.888	53.62	0.0299	-16.70	0.442	-155.05
2.20	0.826	-175.58	5.628	51.17	0.0297	-18.03	0.447	-156.36
2.30	0.826	-173.70	5.391	48.76	0.0295	-19.31	0.453	-157.64
2.40	0.826	-171.87	5.174	46.38	0.0293	-20.52	0.458	-158.90
2.50	0.825	-170.07	4.975	44.02	0.0291	-21.68	0.463	-160.15
2.60	0.825	-168.30	4.791	41.69	0.0288	-22.78	0.468	-161.38
2.70	0.825	-166.56	4.622	39.37	0.0286	-23.83	0.473	-162.61
2.80	0.824	-164.83	4.465	37.08	0.0284	-24.82	0.478	-163.84
2.90	0.824	-163.12	4.320	34.80	0.0282	-25.76	0.483	-165.07
3.00	0.824	-161.41	4.185	32.54	0.0280	-26.64	0.488	-166.31
3.20	0.823	-158.01	3.941	28.06	0.0276	-28.24	0.496	-168.79
3.40	0.821	-154.60	3.730	23.61	0.0272	-29.61	0.505	-171.31
3.60	0.820	-151.17	3.545	19.19	0.0268	-30.76	0.512	-173.86
3.80	0.818	-147.68	3.382	14.76	0.0265	-31.70	0.519	-176.46
4.00	0.816	-144.13	3.239	10.34	0.0262	-32.41	0.525	-179.10
4.20	0.814	-140.49	3.113	5.89	0.0260	-32.91	0.531	-178.20
4.40	0.811	-136.74	3.002	1.42	0.0259	-33.20	0.535	-175.44
4.60	0.809	-132.85	2.905	-3.10	0.0259	-33.31	0.539	-172.61
4.80	0.806	-128.81	2.821	-7.68	0.0261	-33.28	0.542	-169.69
5.00	0.802	-124.60	2.746	-12.33	0.0264	-33.14	0.544	-166.67
5.20	0.799	-120.21	2.680	-17.05	0.0269	-32.94	0.545	-163.54
5.40	0.795	-115.62	2.622	-21.86	0.0276	-32.76	0.545	-160.28
5.60	0.791	-110.82	2.569	-26.77	0.0286	-32.65	0.544	-156.88
5.80	0.787	-105.80	2.522	-31.78	0.0297	-32.69	0.542	-153.33
6.00	0.783	-100.56	2.479	-36.91	0.0311	-32.95	0.540	-149.60

Typical Package S-Parameters for CG2H40010
 (Small Signal, $V_{DS} = 28\text{ V}$, $I_{DQ} = 200\text{ mA}$, angle in degrees)

Frequency	Mag S11	Ang S11	Mag S21	Ang S21	Mag S12	Ang S12	Mag S22	Ang S22
0.50	0.874	-125.62	23.065	107.16	0.0231	22.83	0.390	-121.46
0.60	0.865	-135.15	19.881	101.04	0.0238	17.87	0.389	-129.56
0.70	0.858	-142.64	17.413	95.93	0.0243	13.91	0.390	-135.68
0.80	0.853	-148.74	15.461	91.50	0.0246	10.65	0.391	-140.43
0.90	0.850	-153.82	13.887	87.55	0.0248	7.88	0.393	-144.22
1.00	0.848	-158.16	12.595	83.95	0.0249	5.47	0.395	-147.32
1.10	0.846	-161.95	11.518	80.62	0.0250	3.34	0.397	-149.92
1.20	0.844	-165.32	10.608	77.50	0.0250	1.43	0.400	-152.13
1.30	0.843	-168.35	9.830	74.53	0.0251	-0.30	0.403	-154.05
1.40	0.842	-171.12	9.158	71.70	0.0250	-1.89	0.406	-155.75
1.50	0.841	-173.68	8.572	68.96	0.0250	-3.36	0.410	-157.29
1.60	0.840	-176.06	8.057	66.32	0.0250	-4.72	0.413	-158.68
1.70	0.839	-178.31	7.600	63.74	0.0249	-5.99	0.417	-159.98
1.80	0.839	179.55	7.194	61.23	0.0249	-7.17	0.420	-161.20
1.90	0.838	177.51	6.830	58.76	0.0248	-8.29	0.424	-162.36
2.00	0.838	175.55	6.502	56.34	0.0247	-9.33	0.428	-163.47
2.10	0.837	173.65	6.206	53.96	0.0247	-10.31	0.432	-164.54
2.20	0.836	171.80	5.936	51.60	0.0246	-11.23	0.436	-165.60
2.30	0.836	170.00	5.690	49.28	0.0245	-12.10	0.440	-166.63
2.40	0.835	168.24	5.466	46.98	0.0244	-12.91	0.444	-167.65
2.50	0.835	166.50	5.259	44.70	0.0244	-13.66	0.447	-168.67
2.60	0.834	164.79	5.070	42.43	0.0243	-14.37	0.451	-169.68
2.70	0.833	163.09	4.894	40.19	0.0242	-15.02	0.455	-170.70
2.80	0.832	161.41	4.732	37.95	0.0242	-15.63	0.459	-171.72
2.90	0.832	159.73	4.582	35.73	0.0241	-16.19	0.462	-172.74
3.00	0.831	158.06	4.443	33.52	0.0241	-16.70	0.466	-173.78
3.20	0.829	154.72	4.192	29.12	0.0241	-17.58	0.472	-175.88
3.40	0.827	151.37	3.974	24.74	0.0241	-18.30	0.478	-178.04
3.60	0.825	147.98	3.783	20.37	0.0241	-18.86	0.484	179.75
3.80	0.822	144.53	3.615	15.99	0.0243	-19.28	0.489	177.48
4.00	0.820	141.00	3.467	11.59	0.0245	-19.59	0.493	175.13
4.20	0.817	137.38	3.337	7.16	0.0248	-19.82	0.497	172.72
4.40	0.813	133.65	3.223	2.69	0.0253	-20.00	0.500	170.22
4.60	0.810	129.77	3.122	-1.84	0.0259	-20.17	0.502	167.64
4.80	0.806	125.74	3.034	-6.43	0.0267	-20.38	0.504	164.95
5.00	0.802	121.53	2.956	-11.09	0.0276	-20.67	0.504	162.15
5.20	0.798	117.14	2.887	-15.84	0.0287	-21.10	0.504	159.21
5.40	0.794	112.55	2.825	-20.68	0.0300	-21.69	0.503	156.13
5.60	0.789	107.75	2.770	-25.62	0.0315	-22.49	0.502	152.90
5.80	0.785	102.74	2.719	-30.66	0.0331	-23.54	0.499	149.49
6.00	0.780	97.50	2.672	-35.82	0.0350	-24.86	0.496	145.89

Typical Package S-Parameters for CG2H40010
 (Small Signal, $V_{DS} = 28\text{ V}$, $I_{DQ} = 500\text{ mA}$, angle in degrees)

Frequency	Mag S11	Ang S11	Mag S21	Ang S21	Mag S12	Ang S12	Mag S22	Ang S22
0.50	0.884	-133.72	22.181	103.56	0.0199	20.32	0.356	-129.90
0.60	0.878	-142.44	18.972	97.82	0.0203	15.95	0.358	-136.80
0.70	0.873	-149.25	16.532	93.01	0.0206	12.53	0.360	-141.87
0.80	0.870	-154.75	14.626	88.83	0.0208	9.75	0.363	-145.73
0.90	0.868	-159.35	13.103	85.08	0.0209	7.42	0.366	-148.77
1.00	0.866	-163.28	11.861	81.66	0.0210	5.42	0.369	-151.23
1.10	0.865	-166.73	10.830	78.47	0.0210	3.68	0.373	-153.26
1.20	0.864	-169.80	9.963	75.46	0.0210	2.13	0.376	-154.99
1.30	0.863	-172.59	9.223	72.59	0.0210	0.75	0.380	-156.50
1.40	0.862	-175.15	8.585	69.83	0.0210	-0.50	0.384	-157.83
1.50	0.861	-177.52	8.030	67.17	0.0210	-1.64	0.388	-159.04
1.60	0.861	-179.75	7.543	64.58	0.0209	-2.67	0.393	-160.15
1.70	0.860	178.13	7.112	62.05	0.0209	-3.61	0.397	-161.19
1.80	0.860	176.12	6.729	59.58	0.0208	-4.47	0.402	-162.19
1.90	0.859	174.18	6.386	57.15	0.0208	-5.25	0.406	-163.15
2.00	0.859	172.31	6.077	54.76	0.0207	-5.97	0.411	-164.08
2.10	0.858	170.49	5.797	52.40	0.0207	-6.61	0.415	-165.00
2.20	0.857	168.71	5.544	50.07	0.0207	-7.20	0.420	-165.92
2.30	0.857	166.97	5.313	47.76	0.0206	-7.72	0.424	-166.83
2.40	0.856	165.25	5.101	45.48	0.0206	-8.19	0.429	-167.74
2.50	0.856	163.56	4.907	43.21	0.0206	-8.60	0.433	-168.66
2.60	0.855	161.89	4.729	40.96	0.0205	-8.95	0.438	-169.59
2.70	0.854	160.23	4.564	38.72	0.0205	-9.26	0.442	-170.53
2.80	0.853	158.57	4.412	36.50	0.0205	-9.51	0.446	-171.48
2.90	0.853	156.92	4.271	34.28	0.0205	-9.71	0.451	-172.45
3.00	0.852	155.27	4.140	32.08	0.0206	-9.87	0.455	-173.43
3.20	0.850	151.96	3.904	27.68	0.0207	-10.05	0.462	-175.45
3.40	0.848	148.62	3.699	23.31	0.0209	-10.08	0.469	-177.54
3.60	0.846	145.23	3.520	18.93	0.0212	-10.00	0.476	-179.70
3.80	0.843	141.78	3.362	14.55	0.0215	-9.85	0.482	178.06
4.00	0.840	138.24	3.223	10.14	0.0220	-9.66	0.487	175.75
4.20	0.837	134.60	3.101	5.70	0.0227	-9.48	0.492	173.36
4.40	0.834	130.83	2.994	1.21	0.0235	-9.38	0.495	170.88
4.60	0.831	126.92	2.899	-3.33	0.0244	-9.39	0.498	168.30
4.80	0.827	122.84	2.816	-7.93	0.0256	-9.56	0.500	165.62
5.00	0.823	118.59	2.743	-12.62	0.0269	-9.95	0.502	162.83
5.20	0.819	114.14	2.678	-17.39	0.0284	-10.59	0.502	159.90
5.40	0.815	109.50	2.619	-22.25	0.0301	-11.49	0.502	156.82
5.60	0.811	104.65	2.566	-27.21	0.0320	-12.69	0.501	153.59
5.80	0.807	99.58	2.518	-32.28	0.0341	-14.20	0.499	150.18
6.00	0.802	94.29	2.473	-37.47	0.0364	-16.03	0.496	146.59

Product Dimensions CG2H40010F (Package Type — 440166)

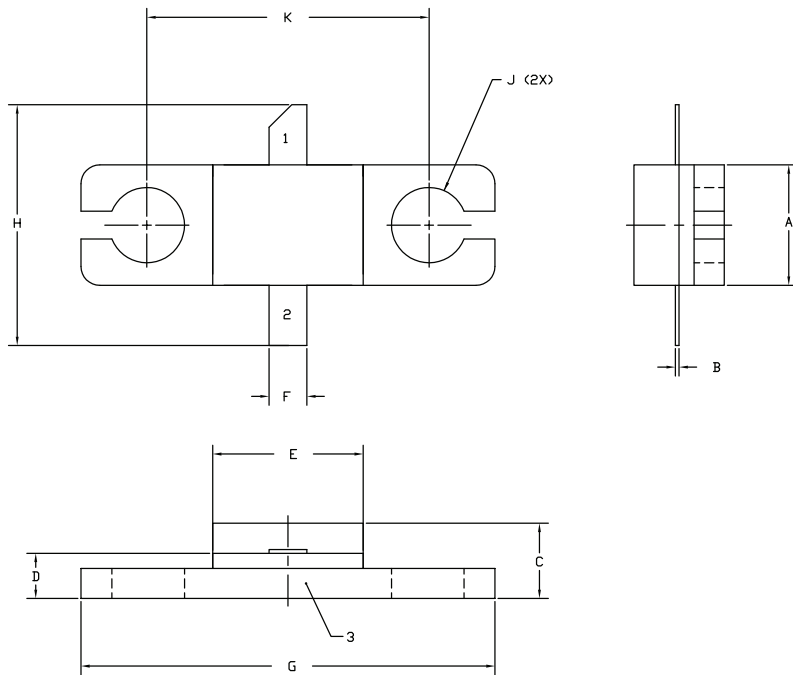

- NOTES:
1. DIMENSIONING AND TOLERANCING PER ANSI Y14.5M, 1982.
 2. CONTROLLING DIMENSION: INCH.
 3. ADHESIVE FROM LID MAY EXTEND A MAXIMUM OF 0.020" BEYOND EDGE OF LID.
 4. LID MAY BE MISALIGNED TO THE BODY OF THE PACKAGE BY A MAXIMUM OF 0.008" IN ANY DIRECTION.
 5. ALL PLATED SURFACES ARE NI/AU

DIM	INCHES		MILLIMETERS	
	MIN	MAX	MIN	MAX
A	0.155	0.165	3.94	4.19
B	0.004	0.006	0.10	0.15
C	0.115	0.135	2.92	3.43
D	0.057	0.067	1.45	1.70
E	0.195	0.205	4.95	5.21
F	0.045	0.055	1.14	1.40
G	0.545	0.555	13.84	14.09
H	0.280	0.360	7.11	9.14
J	Ø .100		2.54	
K	0.375		9.53	

- PIN 1. GATE
 PIN 2. DRAIN
 PIN 3. SOURCE

Product Dimensions CG2H40010P (Package Type — 440196)

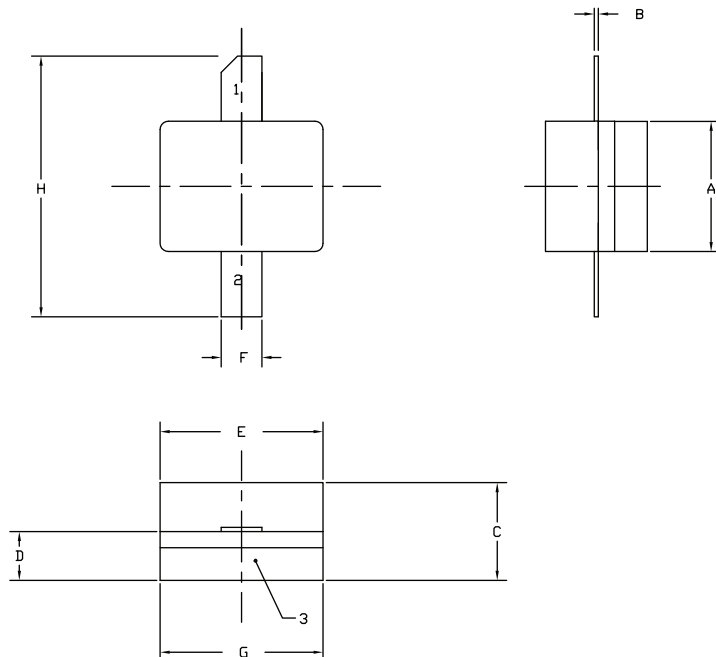



- NOTES:
1. DIMENSIONING AND TOLERANCING PER ANSI Y14.5M, 1982.
 2. CONTROLLING DIMENSION: INCH.
 3. ADHESIVE FROM LID MAY EXTEND A MAXIMUM OF 0.020" BEYOND EDGE OF LID.
 4. LID MAY BE MISALIGNED TO THE BODY OF THE PACKAGE BY A MAXIMUM OF 0.008" IN ANY DIRECTION.
 5. ALL PLATED SURFACES ARE NI/AU

DIM	INCHES		MILLIMETERS	
	MIN	MAX	MIN	MAX
A	0.155	0.165	3.94	4.19
B	0.003	0.006	0.10	0.15
C	0.115	0.135	2.92	3.17
D	0.057	0.067	1.45	1.70
E	0.195	0.205	4.95	5.21
F	0.045	0.055	1.14	1.40
G	0.195	0.205	4.95	5.21
H	0.280	0.360	7.11	9.14

- PIN 1. GATE
 PIN 2. DRAIN
 PIN 3. SOURCE

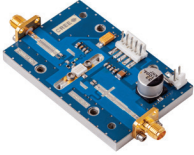

Product Ordering Information

Order Number	Description	Unit of Measure	Image
CG2H40010F	GaN HEMT	Each	
CG2H40010P	GaN HEMT	Each	
CG2H40010F-AMP	Test board with GaN HEMT installed		



For more information, please contact:

4600 Silicon Drive
Durham, North Carolina, USA 27703
www.wolfspeed.com/rf

Sales Contact
rfsales@cree.com

Notes & Disclaimer

Specifications are subject to change without notice. “Typical” parameters are the average values expected by Cree in large quantities and are provided for information purposes only. Cree products are not warranted or authorized for use as critical components in medical, life-saving, or life-sustaining applications, or other applications where a failure would reasonably be expected to cause severe personal injury or death. No responsibility is assumed by Cree for any infringement of patents or other rights of third parties which may result from use of the information contained herein. No license is granted by implication or otherwise under any patent or patent rights of Cree.

© 2017 – 2021 Cree, Inc. All rights reserved. Wolfspeed® and the Wolfspeed logo are registered trademarks of Cree, Inc.