

Surface Mount

Monolithic Amplifier

0.05-1 GHz

Product Features

- Wideband, 0.05 to 1GHz
- High output power, up to +17.5 dBm typ.
- Low noise, 3.6 dB typ.
- Aqueous washable

Typical Applications

- UHF - TV
- Cellular
- Defense communication
- UHF/VHF receivers/transmitters



Generic photo used for illustration purposes only

MAV-11SM+

CASE STYLE: RRR137-1

+RoHS Compliant

The +Suffix identifies RoHS Compliance. See our web site for RoHS Compliance methodologies and qualifications

General Description

MAV-11SM+ (RoHS compliant) is a wideband amplifier offering high dynamic range. It has repeatable performance from lot to lot. It is enclosed in a plastic molded package. MAV-11SM+ uses Darlington configuration and is fabricated using silicon technology. Expected MTBF is 500 years at 85°C case temperature.

simplified schematic and pin description

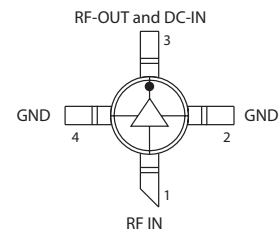
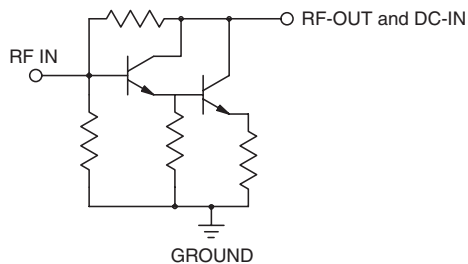

Function	Pin Number	Description
RF IN	1	RF input pin. This pin requires the use of an external DC blocking capacitor chosen for the frequency of operation.
RF-OUT and DC-IN	3	RF output and bias pin. DC voltage is present on this pin; therefore a DC blocking capacitor is necessary for proper operation. An RF choke is needed to feed DC bias without loss of RF signal due to the bias connection, as shown in "Recommended Application Circuit".
GND	2,4	Connections to ground. Use via holes as shown in "Suggested Layout for PCB Design" to reduce ground path inductance for best performance.

Notes

- Performance and quality attributes and conditions not expressly stated in this specification document are intended to be excluded and do not form a part of this specification document.
- Electrical specifications and performance data contained in this specification document are based on Mini-Circuit's applicable established test performance criteria and measurement instructions.
- The parts covered by this specification document are subject to Mini-Circuits standard limited warranty and terms and conditions (collectively, "Standard Terms"); Purchasers of this part are entitled to the rights and benefits contained therein. For a full statement of the Standard Terms and the exclusive rights and remedies thereunder, please visit Mini-Circuits' website at www.minicircuits.com/MCLStore/terms.jsp



Electrical Specifications at 25°C and 60mA, unless noted

Parameter	Min.	Typ.	Max.	Units	
Frequency Range*	0.05		1	GHz	
Gain	f=0.1 GHz f=1 GHz	— 9.0 ²	12.7 10.5	— —	dB
Input Return Loss	f=0.05 to 1 GHz		14		dB
Output Return Loss	f=0.05 to 1 GHz		11.5		dB
Output Power @ 1 dB compression	f=0.5 GHz		+17.5		dBm
Output IP3	f=0.5 GHz		+30		dBm
Noise Figure	f=0.5 GHz		3.6		dB
Recommended Device Operating Current			60		mA
Device Operating Voltage			5.5		V
Thermal Resistance, junction-to-case ¹			125		°C/W

*Guaranteed specification 0.05-1 GHz. Low frequency cut off determined by external coupling capacitors.

Absolute Maximum Ratings

Parameter	Ratings
Operating Temperature*	-20°C to 85°C
Storage Temperature	-55°C to 100°C
Operating Current	80mA
Power Dissipation	550mW
Input Power	13dBm

Note: Permanent damage may occur if any of these limits are exceeded.

These ratings are not intended for continuous normal operation.

¹Case is defined as ground leads.

²Full operating temperature range

Notes

- A. Performance and quality attributes and conditions not expressly stated in this specification document are intended to be excluded and do not form a part of this specification document.
 B. Electrical specifications and performance data contained in this specification document are based on Mini-Circuit's applicable established test performance criteria and measurement instructions.
 C. The parts covered by this specification document are subject to Mini-Circuits standard limited warranty and terms and conditions (collectively, "Standard Terms"); Purchasers of this part are entitled to the rights and benefits contained therein. For a full statement of the Standard Terms and the exclusive rights and remedies thereunder, please visit Mini-Circuits' website at www.minicircuits.com/MCLStore/terms.jsp



Product Marking

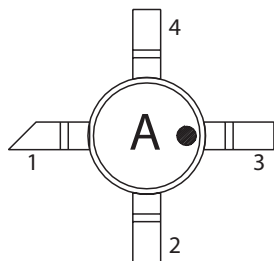

Markings in addition to model number designation may appear for internal quality control purposes.

Additional Detailed Technical Information

Additional information is available on our web site. To access this information enter the model number on our web site home page.

Performance data, graphs, s-parameter data set (.zip file)

Case Style: RRR137-1

Plastic molded package, .145 body diameter, lead finish: tin

Tape & Reel: F11

7" reels with 20, 50, 100, 200, 500 devices

Suggested Layout for PCB Design: PL-169

Evaluation Board: TB-412-11+

Environmental Ratings: ENV08

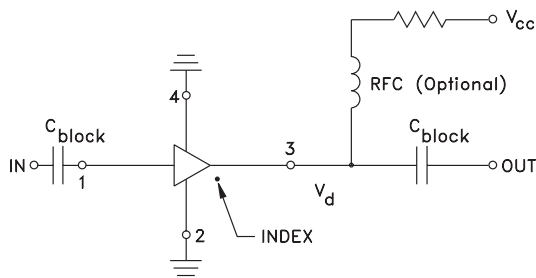

R BIAS	
Vcc	"1%" Res. Values (ohms) for Optimum Biasing
7	28.0
8	45.3
9	61.9
10	78.7
11	95.3
12	113
13	127
14	143
15	158

Notes

- A. Performance and quality attributes and conditions not expressly stated in this specification document are intended to be excluded and do not form a part of this specification document.
- B. Electrical specifications and performance data contained in this specification document are based on Mini-Circuit's applicable established test performance criteria and measurement instructions.
- C. The parts covered by this specification document are subject to Mini-Circuits standard limited warranty and terms and conditions (collectively, "Standard Terms"); Purchasers of this part are entitled to the rights and benefits contained therein. For a full statement of the Standard Terms and the exclusive rights and remedies thereunder, please visit Mini-Circuits' website at www.minicircuits.com/MCLStore/terms.jsp



ESD Rating

Human Body Model (HBM): Class 0 (< 250 v) in accordance with ANSI/ESD STM 5.1 - 2001

Charged Device Model (CDM): Class III (500v to 1000 v) in accordance with JESD22-C101C

MSL Rating

Moisture Sensitivity: MSL1 in accordance with IPC/JEDECJ-STD-020C

No.	Test Required	Condition	Standard	Quantity
1	Visual Inspection	Low Power Microscope Magnification 40x	MIP-IN-0003 (MCT spec)	20 units
2	Electrical Test	Room Temperature	SCD (MCL spec)	20 units
3	SAM Analysis	Less than 10% growth in term of delamination	J-Std-020C (Jedec Standard)	20 units
4	Moisture Sensitivity Level 1	Bake at 125°C for 24 hours Soak at 85°C/85%RH for 168 hours Reflow 3 cycles at 260°C peak	J-Std-020C (Jedec Standard)	20 units

MSL Test Flow Chart

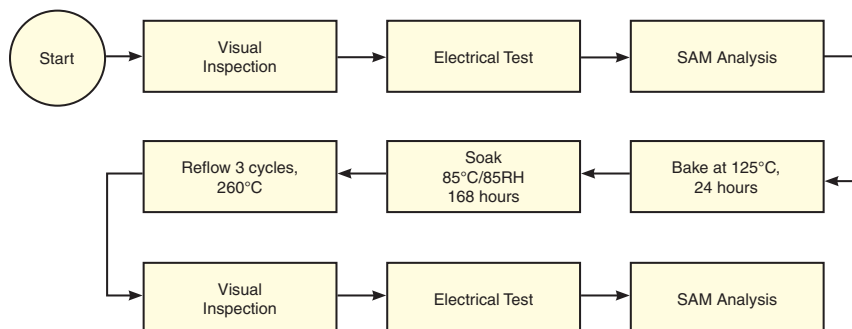

Notes

- A. Performance and quality attributes and conditions not expressly stated in this specification document are intended to be excluded and do not form a part of this specification document.
- B. Electrical specifications and performance data contained in this specification document are based on Mini-Circuit's applicable established test performance criteria and measurement instructions.
- C. The parts covered by this specification document are subject to Mini-Circuits standard limited warranty and terms and conditions (collectively, "Standard Terms"); Purchasers of this part are entitled to the rights and benefits contained therein. For a full statement of the Standard Terms and the exclusive rights and remedies thereunder, please visit Mini-Circuits' website at www.minicircuits.com/MCLStore/terms.jsp



Typical Performance Data

**NOTE: Use PDF Bookmarks to view DATA at required conditions
or to view GRAPHS.**

Definitions:

Input Return Loss = -S11 (dB)

Gain(Power Gain) = S21 (dB)

Reverse Isolation = -S12 (dB)

Output Return Loss = -S22 (dB)

TEST CONDITIONS: Icc = 60mA, Vd = 5.21V @Temperature = +25degC

FREQ	Gain	Isolation	Input Return Loss	Output Return Loss	Stability		FREQ	IP3 Output	1dB Comp. Output	Noise Figure
(MHz)	(dB)	(dB)	(dB)	(dB)	K	Delta	(MHz)	(dBm)	(dBm)	(dB)
50	12.48	16.34	30.70	28.83	1.10	0.64	50	34.30	18.28	3.24
100	12.43	16.31	33.59	28.93	1.10	0.64	100	34.26	18.25	3.43
150	12.37	16.25	32.14	27.32	1.10	0.64	150	34.66	18.24	3.32
200	12.33	16.23	31.03	25.56	1.10	0.64	200	33.94	18.11	3.28
250	12.27	16.15	29.60	23.81	1.10	0.64	250	33.40	18.10	3.38
300	12.20	16.10	27.90	22.58	1.09	0.64	300	33.54	17.90	3.66
350	12.12	16.00	26.78	21.35	1.09	0.64	350	33.49	17.95	3.52
400	12.03	15.94	25.61	20.23	1.09	0.63	400	33.15	18.29	3.47
450	11.94	15.85	24.55	19.24	1.09	0.63	450	32.78	18.02	3.49
500	11.84	15.76	23.36	18.42	1.09	0.63	500	32.61	18.00	3.59
550	11.73	15.65	22.54	17.57	1.08	0.63	550	32.36	17.79	3.63
600	11.62	15.54	21.40	16.93	1.08	0.63	600	32.02	18.02	3.58
650	11.50	15.44	20.65	16.28	1.08	0.63	650	31.61	17.99	3.63
700	11.37	15.32	19.92	15.66	1.07	0.63	700	31.35	17.99	3.80
750	11.24	15.22	18.98	15.09	1.07	0.63	750	30.97	18.03	3.85
800	11.11	15.10	18.37	14.61	1.07	0.63	800	30.54	17.89	3.88
850	10.97	14.98	17.64	14.11	1.07	0.63	850	30.28	17.98	3.81
900	10.83	14.87	17.04	13.68	1.06	0.63	900	29.94	17.97	3.89
950	10.67	14.77	16.45	13.25	1.06	0.63	940	29.73	17.83	4.00
1000	10.52	14.64	15.88	12.87	1.06	0.63	1000	29.26	17.72	3.99
1100	10.21	14.41	14.86	12.19	1.06	0.63	1050	28.97	17.71	3.97
1200	9.91	14.21	13.93	11.62	1.05	0.63	1100	28.67	17.53	4.04
1400	9.28	13.79	12.37	10.67	1.05	0.62	1150	28.47	17.41	4.20
1600	8.63	13.46	11.16	10.00	1.05	0.62	1200	28.31	17.28	4.24
1800	8.01	13.14	10.21	9.48	1.05	0.61	1250	27.92	17.19	4.15
2000	7.42	12.83	9.38	9.09	1.05	0.60	1300	27.62	17.01	4.34
2200	6.85	12.60	8.69	8.81	1.05	0.60	1350	27.42	16.83	4.44
2400	6.24	12.42	8.03	8.58	1.06	0.58	1400	27.35	16.84	4.40
2600	5.69	12.28	7.52	8.43	1.08	0.58	1450	27.21	16.72	4.43
2800	5.13	12.18	6.91	8.20	1.09	0.57	1500	26.97	16.59	4.63
3000	4.60	12.07	6.37	7.99	1.09	0.56	1550	26.92	16.49	4.75
3200	4.02	12.07	5.86	7.86	1.11	0.55	1600	26.74	16.33	4.85
3400	3.49	12.04	5.33	7.58	1.11	0.55	1650	26.68	16.38	4.89
3600	2.95	12.08	4.88	7.41	1.12	0.54	1700	26.24	16.39	4.91
3800	2.42	12.10	4.42	7.24	1.12	0.54	1750	26.05	16.12	5.01
4000	1.88	12.14	4.04	7.02	1.12	0.53	1800	25.71	16.02	5.07
4500	0.67	12.20	3.31	6.62	1.11	0.52	1850	25.57	15.86	4.99
5000	-0.45	12.13	2.88	6.25	1.08	0.51	1900	25.55	15.82	5.01
5500	-1.50	12.01	2.68	5.87	1.06	0.50	1950	25.18	15.59	5.26
6000	-2.61	11.88	2.59	5.44	1.07	0.49	2000	25.20	15.60	5.35

REV. X1

MAV-11SM+

120125

Page 1 of 11



IF/RF MICROWAVE COMPONENTS • ISO 9001 ISO 14001 AS 9100 CERTIFIED • RoHS compliant

P.O. Box 350166, Brooklyn, New York 11235-0003 (718) 934-4500 Fax (718) 332-4661



The Design Engineers Search Engine finds the model you need, Instantly • For detailed performance specs & shopping online see



MMIC Amplifier

MAV-11SM+

Typical Performance Data

Definitions:

Input Return Loss = -S11 (dB)

Gain(Power Gain) = S21 (dB)

Reverse Isolation = -S12 (dB)

Output Return Loss = -S22 (dB)

TEST CONDITIONS: Icc = 48mA, Vd = 5.01V @Temperature = +25degC

FREQ	Gain	Isolation	Input Return Loss	Output Return Loss	Stability		FREQ	IP3 Output	1dB Comp. Output	Noise Figure
					K	Delta				
(MHz)	(dB)	(dB)	(dB)	(dB)	K	Delta	(MHz)	(dBm)	(dBm)	(dB)
50	12.38	16.21	29.67	29.18	1.10	0.64	50	32.59	16.13	3.17
100	12.32	16.20	31.79	29.13	1.10	0.64	100	32.59	16.06	3.32
150	12.28	16.20	31.06	27.43	1.10	0.64	150	33.10	16.11	3.24
200	12.23	16.15	30.39	25.76	1.10	0.64	200	32.58	15.88	3.21
250	12.17	16.08	29.07	23.98	1.10	0.64	250	31.82	15.90	3.29
300	12.10	16.03	27.68	22.73	1.10	0.63	300	32.54	15.70	3.61
350	12.02	15.95	26.71	21.51	1.09	0.63	350	32.37	15.79	3.46
400	11.94	15.86	25.63	20.38	1.09	0.63	400	32.15	16.13	3.39
450	11.85	15.76	24.61	19.39	1.09	0.63	450	31.82	15.81	3.41
500	11.74	15.68	23.45	18.58	1.08	0.63	500	31.96	15.80	3.51
550	11.64	15.57	22.65	17.72	1.08	0.63	550	31.79	15.64	3.55
600	11.53	15.46	21.51	17.06	1.08	0.63	600	31.65	16.00	3.50
650	11.40	15.36	20.76	16.41	1.08	0.63	650	31.45	16.03	3.54
700	11.27	15.24	20.02	15.79	1.07	0.63	700	31.37	16.07	3.69
750	11.14	15.12	19.10	15.23	1.07	0.63	750	31.26	16.15	3.76
800	11.02	15.01	18.47	14.73	1.07	0.63	800	30.99	16.05	3.80
850	10.88	14.90	17.72	14.23	1.06	0.63	850	30.90	16.27	3.73
900	10.74	14.79	17.11	13.78	1.06	0.63	900	30.71	16.38	3.81
950	10.58	14.68	16.51	13.35	1.06	0.63	940	30.56	16.26	3.93
1000	10.43	14.56	15.93	12.98	1.06	0.62	1000	30.13	16.25	3.94
1100	10.12	14.35	14.91	12.28	1.05	0.62	1050	29.92	16.41	3.87
1200	9.82	14.12	13.98	11.68	1.05	0.62	1100	29.65	16.32	3.96
1400	9.19	13.72	12.40	10.69	1.04	0.62	1150	29.54	16.35	4.14
1600	8.54	13.38	11.20	9.99	1.05	0.61	1200	29.33	16.28	4.15
1800	7.93	13.05	10.26	9.43	1.05	0.61	1250	29.03	16.36	4.06
2000	7.36	12.75	9.46	9.00	1.04	0.60	1300	28.65	16.25	4.25
2200	6.78	12.52	8.77	8.70	1.05	0.59	1350	28.44	16.17	4.36
2400	6.20	12.31	8.12	8.42	1.06	0.59	1400	28.41	16.27	4.30
2600	5.65	12.17	7.61	8.21	1.07	0.58	1450	28.24	16.27	4.33
2800	5.09	12.06	7.01	7.96	1.08	0.57	1500	28.01	16.16	4.55
3000	4.58	11.94	6.47	7.72	1.09	0.57	1550	27.91	16.14	4.65
3200	4.01	11.95	5.96	7.56	1.10	0.56	1600	27.81	15.98	4.79
3400	3.50	11.90	5.43	7.29	1.10	0.56	1650	27.75	16.15	4.82
3600	2.95	11.94	4.97	7.11	1.12	0.55	1700	27.41	16.14	4.82
3800	2.43	11.98	4.51	6.91	1.12	0.55	1750	27.09	15.98	4.91
4000	1.91	12.00	4.13	6.69	1.12	0.55	1800	26.77	15.88	4.99
4500	0.72	12.08	3.40	6.30	1.10	0.54	1850	26.67	15.71	4.94
5000	-0.35	12.05	2.97	6.01	1.08	0.52	1900	26.57	15.77	4.92
5500	-1.36	11.97	2.75	5.70	1.07	0.51	1950	26.22	15.56	5.18
6000	-2.41	11.87	2.65	5.36	1.08	0.50	2000	26.23	15.63	5.27

REV. X1

MAV-11SM+

120125

Page 2 of 11



IF/RF MICROWAVE COMPONENTS • ISO 9001 ISO 14001 AS 9100 CERTIFIED • RoHS compliant

P.O. Box 350166, Brooklyn, New York 11235-0003 (718) 934-4500 Fax (718) 332-4661



The Design Engineers Search Engine finds the model you need, Instantly • For detailed performance specs & shopping online see



MMIC Amplifier

MAV-11SM+

Typical Performance Data

Definitions:

Input Return Loss = -S11 (dB)

Gain(Power Gain) = S21 (dB)

Reverse Isolation = -S12 (dB)

Output Return Loss = -S22 (dB)

TEST CONDITIONS: Icc = 72mA, Vd = 5.42V @Temperature = +25degC

FREQ	Gain	Isolation	Input Return Loss	Output Return Loss	Stability		FREQ	IP3 Output	1dB Comp. Output	Noise Figure
					K	Delta				
(MHz)	(dB)	(dB)	(dB)	(dB)	K	Delta	(MHz)	(dBm)	(dBm)	(dB)
50	12.53	16.35	30.78	27.91	1.10	0.64	50	35.34	19.83	3.32
100	12.47	16.36	32.53	27.73	1.10	0.64	100	35.22	19.81	3.52
150	12.44	16.30	31.55	26.48	1.10	0.64	150	35.28	19.77	3.42
200	12.38	16.28	30.70	24.92	1.10	0.64	200	34.50	19.74	3.35
250	12.32	16.22	29.43	23.35	1.10	0.64	250	34.23	19.71	3.47
300	12.26	16.17	27.77	22.23	1.10	0.64	300	33.62	19.47	3.76
350	12.18	16.07	26.70	21.08	1.09	0.64	350	33.56	19.46	3.61
400	12.10	15.99	25.59	19.98	1.09	0.64	400	33.03	19.53	3.56
450	12.01	15.91	24.56	19.04	1.09	0.64	450	32.65	19.27	3.58
500	11.90	15.82	23.39	18.26	1.09	0.64	500	32.19	19.15	3.68
550	11.80	15.71	22.56	17.45	1.08	0.64	550	31.81	18.93	3.72
600	11.69	15.60	21.45	16.79	1.08	0.64	600	31.30	18.98	3.67
650	11.57	15.48	20.72	16.17	1.08	0.64	650	30.81	18.87	3.72
700	11.44	15.37	20.00	15.57	1.07	0.64	700	30.40	18.83	3.90
750	11.31	15.26	19.06	15.02	1.07	0.64	750	29.91	18.69	3.94
800	11.18	15.15	18.44	14.53	1.07	0.64	800	29.37	18.47	3.95
850	11.04	15.02	17.72	14.06	1.07	0.64	850	29.04	18.35	3.89
900	10.90	14.91	17.09	13.65	1.06	0.64	900	28.66	18.25	3.98
950	10.75	14.81	16.48	13.21	1.06	0.63	940	28.37	17.99	4.11
1000	10.61	14.67	15.91	12.86	1.06	0.64	1000	27.91	17.75	4.08
1100	10.29	14.46	14.86	12.21	1.06	0.63	1050	27.64	17.58	4.07
1200	9.98	14.24	13.91	11.66	1.05	0.63	1100	27.34	17.34	4.14
1400	9.33	13.84	12.27	10.76	1.05	0.63	1150	27.13	17.15	4.29
1600	8.66	13.52	11.03	10.18	1.05	0.61	1200	26.94	17.00	4.34
1800	8.03	13.21	10.04	9.72	1.05	0.61	1250	26.53	16.84	4.27
2000	7.43	12.94	9.18	9.42	1.06	0.60	1300	26.22	16.59	4.43
2200	6.82	12.73	8.47	9.22	1.07	0.58	1350	26.01	16.37	4.56
2400	6.21	12.56	7.79	9.04	1.08	0.57	1400	25.99	16.34	4.47
2600	5.63	12.45	7.26	8.94	1.09	0.56	1450	25.83	16.24	4.51
2800	5.04	12.36	6.67	8.78	1.10	0.55	1500	25.63	16.02	4.73
3000	4.48	12.28	6.12	8.59	1.11	0.54	1550	25.60	15.93	4.84
3200	3.90	12.29	5.63	8.51	1.13	0.53	1600	25.39	15.74	4.97
3400	3.34	12.26	5.10	8.23	1.13	0.52	1650	25.33	15.76	4.99
3600	2.78	12.30	4.66	8.07	1.14	0.51	1700	24.91	15.67	5.01
3800	2.23	12.33	4.22	7.86	1.14	0.51	1750	24.69	15.44	5.10
4000	1.67	12.34	3.85	7.61	1.14	0.50	1800	24.37	15.32	5.19
4500	0.38	12.36	3.16	7.07	1.11	0.49	1850	24.30	15.15	5.12
5000	-0.80	12.24	2.74	6.52	1.08	0.49	1900	24.27	15.03	5.14
5500	-1.93	12.05	2.56	5.95	1.06	0.48	1950	23.91	14.84	5.37
6000	-3.10	11.87	2.49	5.37	1.07	0.49	2000	23.99	14.84	5.48

REV. X1

MAV-11SM+

120125

Page 3 of 11



IF/RF MICROWAVE COMPONENTS • ISO 9001 ISO 14001 AS 9100 CERTIFIED • RoHS compliant

P.O. Box 350166, Brooklyn, New York 11235-0003 (718) 934-4500 Fax (718) 332-4661



The Design Engineers Search Engine finds the model you need, Instantly • For detailed performance specs & shopping online see



MMIC Amplifier

MAV-11SM+

Typical Performance Data

Definitions:

Input Return Loss = -S11 (dB)

Gain(Power Gain) = S21 (dB)

Reverse Isolation = -S12 (dB)

Output Return Loss = -S22 (dB)

TEST CONDITIONS: Icc = 60mA, Vd = 6.04V @Temperature = -45degC

FREQ	Gain	Isolation	Input Return Loss	Output Return Loss	Stability		FREQ	IP3 Output	1dB Comp. Output	Noise Figure
					K	Delta				
(MHz)	(dB)	(dB)	(dB)	(dB)	K	Delta	(MHz)	(dBm)	(dBm)	(dB)
50	12.68	16.41	27.69	27.44	1.09	0.65	50	35.91	18.24	2.87
100	12.64	16.36	28.83	26.94	1.09	0.65	100	35.92	18.18	3.02
150	12.60	16.34	28.33	25.81	1.09	0.65	150	36.46	18.17	2.96
200	12.55	16.30	28.26	24.83	1.09	0.65	200	35.77	18.06	2.96
250	12.50	16.23	27.87	23.60	1.09	0.65	250	35.04	18.04	3.02
300	12.44	16.16	27.20	22.70	1.08	0.65	300	35.48	17.91	3.37
350	12.36	16.09	26.55	21.65	1.08	0.65	350	35.38	17.93	3.16
400	12.28	16.00	25.74	20.61	1.08	0.65	400	35.12	18.25	3.11
450	12.19	15.90	25.03	19.67	1.08	0.65	450	34.79	17.97	3.11
500	12.09	15.81	24.10	18.89	1.07	0.65	500	34.80	17.97	3.17
550	11.99	15.70	23.48	18.07	1.07	0.65	550	34.65	17.83	3.23
600	11.89	15.59	22.33	17.47	1.07	0.65	600	34.47	18.12	3.22
650	11.77	15.48	21.58	16.83	1.06	0.64	650	34.09	18.17	3.23
700	11.64	15.36	20.88	16.24	1.06	0.64	700	34.03	18.16	3.34
750	11.53	15.23	19.92	15.70	1.06	0.65	750	33.78	18.27	3.44
800	11.40	15.12	19.27	15.20	1.05	0.64	800	33.48	18.27	3.50
850	11.27	15.01	18.58	14.72	1.05	0.64	850	33.35	18.48	3.38
900	11.13	14.88	17.93	14.27	1.05	0.64	900	33.17	18.57	3.45
950	10.98	14.77	17.35	13.82	1.05	0.64	940	33.05	18.46	3.54
1000	10.84	14.65	16.76	13.43	1.04	0.64	1000	32.61	18.41	3.61
1100	10.55	14.42	15.70	12.71	1.04	0.64	1050	32.41	18.55	3.53
1200	10.26	14.20	14.70	12.08	1.04	0.64	1100	32.15	18.50	3.54
1400	9.65	13.78	13.10	10.99	1.03	0.64	1150	32.05	18.46	3.74
1600	9.03	13.39	11.96	10.32	1.03	0.63	1200	31.83	18.40	3.80
1800	8.45	13.02	10.95	9.67	1.03	0.63	1250	31.59	18.49	3.71
2000	7.91	12.70	10.16	9.17	1.02	0.63	1300	31.25	18.38	3.85
2200	7.36	12.43	9.45	8.85	1.03	0.63	1350	31.05	18.28	3.96
2400	6.83	12.15	8.67	8.49	1.03	0.63	1400	31.01	18.39	3.93
2600	6.27	12.01	8.05	8.23	1.04	0.62	1450	30.84	18.40	3.96
2800	5.78	11.84	7.40	7.90	1.04	0.62	1500	30.68	18.30	4.14
3000	5.28	11.68	6.75	7.55	1.04	0.62	1550	30.60	18.31	4.25
3200	4.75	11.68	6.18	7.39	1.06	0.61	1600	30.46	18.20	4.38
3400	4.20	11.62	5.54	6.88	1.05	0.62	1650	30.44	18.52	4.39
3600	3.67	11.68	5.02	6.62	1.06	0.61	1700	30.04	18.56	4.39
3800	3.11	11.74	4.51	6.35	1.06	0.61	1750	29.73	18.38	4.46
4000	2.60	11.77	4.08	6.09	1.06	0.61	1800	29.41	18.32	4.57
4500	1.40	11.89	3.34	5.65	1.04	0.60	1850	29.29	18.23	4.50
5000	0.40	11.88	2.87	5.44	1.02	0.59	1900	29.11	18.30	4.49
5500	-0.57	11.84	2.55	5.27	1.00	0.57	1950	28.75	18.11	4.75
6000	-1.60	11.85	2.33	4.96	0.98	0.57	2000	28.73	18.17	4.83

REV. X1

MAV-11SM+

120125

Page 4 of 11



IF/RF MICROWAVE COMPONENTS • ISO 9001 ISO 14001 AS 9100 CERTIFIED • RoHS compliant

P.O. Box 350166, Brooklyn, New York 11235-0003 (718) 934-4500 Fax (718) 332-4661



The Design Engineers Search Engine finds the model you need, Instantly • For detailed performance specs & shopping online see



MMIC Amplifier

MAV-11SM+

Typical Performance Data

Definitions:

Input Return Loss = -S11 (dB)

Gain(Power Gain) = S21 (dB)

Reverse Isolation = -S12 (dB)

Output Return Loss = -S22 (dB)

TEST CONDITIONS: Icc = 48mA, Vd = 5.84V @Temperature = -45degC

FREQ	Gain	Isolation	Input Return Loss	Output Return Loss	Stability		FREQ	IP3 Output	1dB Comp. Output	Noise Figure
(MHz)	(dB)	(dB)	(dB)	(dB)	K	Delta	(MHz)	(dBm)	(dBm)	(dB)
50	12.58	16.29	25.65	25.52	1.09	0.65	50	33.42	16.00	2.80
100	12.54	16.32	26.33	24.96	1.09	0.65	100	33.40	15.95	2.93
150	12.50	16.27	26.14	24.28	1.09	0.65	150	33.92	15.97	2.88
200	12.45	16.23	26.18	23.61	1.09	0.65	200	33.45	15.85	2.89
250	12.40	16.14	26.03	22.73	1.09	0.65	250	32.72	15.81	2.92
300	12.33	16.10	25.80	22.06	1.09	0.65	300	33.47	15.71	3.26
350	12.26	16.00	25.41	21.18	1.08	0.65	350	33.29	15.74	3.08
400	12.18	15.92	24.87	20.32	1.08	0.65	400	33.13	16.11	3.07
450	12.09	15.83	24.39	19.46	1.08	0.64	450	32.83	15.74	3.04
500	12.01	15.74	23.65	18.77	1.07	0.64	500	32.99	15.77	3.08
550	11.91	15.61	23.17	17.97	1.07	0.64	550	32.91	15.63	3.14
600	11.80	15.51	22.17	17.41	1.06	0.64	600	32.85	15.99	3.19
650	11.68	15.40	21.46	16.82	1.06	0.64	650	32.76	16.04	3.16
700	11.57	15.27	20.82	16.26	1.06	0.64	700	32.64	16.01	3.24
750	11.44	15.16	19.91	15.72	1.05	0.64	750	32.75	16.13	3.36
800	11.32	15.03	19.27	15.25	1.05	0.64	800	32.51	16.08	3.40
850	11.19	14.91	18.59	14.77	1.05	0.64	850	32.51	16.38	3.32
900	11.05	14.79	17.98	14.33	1.04	0.64	900	32.40	16.56	3.38
950	10.91	14.69	17.39	13.88	1.04	0.64	940	32.44	16.41	3.47
1000	10.77	14.55	16.82	13.49	1.04	0.64	1000	32.05	16.37	3.53
1100	10.48	14.33	15.74	12.78	1.04	0.64	1050	31.95	16.58	3.45
1200	10.18	14.10	14.74	12.15	1.03	0.64	1100	31.66	16.57	3.44
1400	9.57	13.69	13.12	11.04	1.03	0.64	1150	31.61	16.67	3.67
1600	8.96	13.31	11.98	10.36	1.02	0.63	1200	31.46	16.64	3.74
1800	8.38	12.95	10.95	9.70	1.02	0.63	1250	31.32	16.76	3.64
2000	7.84	12.63	10.17	9.18	1.02	0.63	1300	30.95	16.67	3.78
2200	7.29	12.36	9.44	8.86	1.03	0.62	1350	30.78	16.70	3.88
2400	6.76	12.09	8.67	8.48	1.02	0.62	1400	30.76	16.84	3.85
2600	6.21	11.95	8.06	8.22	1.04	0.62	1450	30.63	16.94	3.90
2800	5.72	11.79	7.41	7.88	1.04	0.62	1500	30.39	16.84	4.05
3000	5.22	11.62	6.76	7.53	1.04	0.62	1550	30.39	16.90	4.15
3200	4.69	11.62	6.20	7.35	1.05	0.61	1600	30.28	16.77	4.32
3400	4.14	11.58	5.55	6.85	1.05	0.61	1650	30.33	17.08	4.32
3600	3.61	11.63	5.03	6.58	1.06	0.61	1700	29.87	17.16	4.30
3800	3.05	11.68	4.53	6.30	1.06	0.61	1750	29.60	17.12	4.39
4000	2.53	11.72	4.10	6.03	1.06	0.61	1800	29.35	17.03	4.50
4500	1.36	11.85	3.35	5.58	1.04	0.60	1850	29.24	16.94	4.40
5000	0.35	11.85	2.89	5.37	1.02	0.59	1900	29.07	17.17	4.42
5500	-0.60	11.81	2.57	5.19	1.00	0.58	1950	28.70	16.95	4.64
6000	-1.62	11.84	2.35	4.89	0.99	0.57	2000	28.64	17.20	4.75

REV. X1

MAV-11SM+

120125

Page 5 of 11



IF/RF MICROWAVE COMPONENTS • ISO 9001 ISO 14001 AS 9100 CERTIFIED • RoHS compliant

P.O. Box 350166, Brooklyn, New York 11235-0003 (718) 934-4500 Fax (718) 332-4661



The Design Engineers Search Engine finds the model you need, Instantly • For detailed performance specs & shopping online see



MMIC Amplifier

MAV-11SM+

Typical Performance Data

Definitions:

Input Return Loss = -S11 (dB)

Gain(Power Gain) = S21 (dB)

Reverse Isolation = -S12 (dB)

Output Return Loss = -S22 (dB)

TEST CONDITIONS: Icc = 72mA, Vd = 6.24V @Temperature = -45degC

FREQ	Gain	Isolation	Input Return Loss	Output Return Loss	Stability		FREQ	IP3 Output	1dB Comp. Output	Noise Figure
(MHz)	(dB)	(dB)	(dB)	(dB)	K	Delta	(MHz)	(dBm)	(dBm)	(dB)
50	12.76	16.41	29.51	28.98	1.09	0.66	50	37.15	19.94	2.97
100	12.71	16.43	31.13	28.63	1.09	0.65	100	37.00	19.91	3.13
150	12.67	16.41	30.37	27.06	1.09	0.65	150	37.41	19.88	3.05
200	12.63	16.35	30.17	25.70	1.09	0.65	200	36.65	19.75	3.03
250	12.57	16.29	29.35	24.16	1.09	0.65	250	36.10	19.73	3.08
300	12.51	16.21	28.24	23.07	1.08	0.65	300	36.07	19.54	3.40
350	12.43	16.14	27.20	21.86	1.08	0.65	350	36.07	19.63	3.25
400	12.35	16.07	26.21	20.76	1.08	0.65	400	35.57	19.93	3.20
450	12.26	15.97	25.36	19.75	1.08	0.65	450	35.30	19.69	3.19
500	12.16	15.88	24.25	18.95	1.07	0.65	500	35.12	19.65	3.27
550	12.06	15.77	23.59	18.08	1.07	0.65	550	34.95	19.49	3.32
600	11.96	15.66	22.37	17.45	1.07	0.65	600	34.64	19.75	3.30
650	11.84	15.55	21.55	16.80	1.07	0.65	650	34.22	19.75	3.29
700	11.72	15.43	20.84	16.22	1.06	0.65	700	34.02	19.79	3.43
750	11.60	15.30	19.86	15.66	1.06	0.65	750	33.60	19.85	3.52
800	11.47	15.19	19.21	15.16	1.06	0.65	800	33.16	19.73	3.56
850	11.33	15.07	18.52	14.67	1.05	0.65	850	32.94	19.87	3.47
900	11.20	14.94	17.88	14.21	1.05	0.65	900	32.67	19.84	3.54
950	11.05	14.84	17.28	13.77	1.05	0.65	940	32.41	19.72	3.64
1000	10.91	14.71	16.71	13.38	1.05	0.65	1000	32.04	19.66	3.67
1100	10.61	14.48	15.64	12.66	1.04	0.65	1050	31.80	19.66	3.60
1200	10.31	14.26	14.65	12.05	1.04	0.65	1100	31.46	19.52	3.62
1400	9.70	13.83	13.05	10.97	1.03	0.64	1150	31.31	19.44	3.82
1600	9.09	13.45	11.91	10.32	1.03	0.64	1200	31.11	19.31	3.87
1800	8.51	13.09	10.89	9.69	1.03	0.64	1250	30.77	19.23	3.78
2000	7.95	12.75	10.11	9.22	1.03	0.63	1300	30.45	19.08	3.93
2200	7.41	12.49	9.38	8.94	1.03	0.63	1350	30.26	18.94	4.06
2400	6.86	12.24	8.61	8.59	1.03	0.62	1400	30.28	18.92	3.99
2600	6.30	12.09	7.99	8.35	1.05	0.62	1450	30.09	18.86	4.04
2800	5.81	11.93	7.32	8.05	1.05	0.61	1500	29.90	18.68	4.20
3000	5.30	11.78	6.66	7.73	1.05	0.62	1550	29.84	18.61	4.34
3200	4.76	11.79	6.10	7.57	1.06	0.61	1600	29.63	18.52	4.45
3400	4.22	11.73	5.46	7.09	1.06	0.61	1650	29.59	18.81	4.48
3600	3.68	11.78	4.95	6.83	1.06	0.61	1700	29.11	18.82	4.49
3800	3.12	11.86	4.44	6.58	1.07	0.60	1750	28.83	18.51	4.55
4000	2.59	11.87	4.01	6.31	1.06	0.60	1800	28.56	18.39	4.66
4500	1.38	12.00	3.26	5.90	1.05	0.59	1850	28.45	18.21	4.57
5000	0.35	11.96	2.80	5.67	1.02	0.58	1900	28.35	18.23	4.58
5500	-0.65	11.90	2.48	5.44	0.99	0.56	1950	27.97	18.08	4.82
6000	-1.72	11.89	2.25	5.08	0.97	0.56	2000	27.96	18.06	4.91

REV. X1

MAV-11SM+

120125

Page 6 of 11



IF/RF MICROWAVE COMPONENTS • ISO 9001 ISO 14001 AS 9100 CERTIFIED • RoHS compliant

P.O. Box 350166, Brooklyn, New York 11235-0003 (718) 934-4500 Fax (718) 332-4661



The Design Engineers Search Engine finds the model you need, Instantly • For detailed performance specs & shopping online see



MMIC Amplifier

MAV-11SM+

Typical Performance Data

Definitions:

Input Return Loss = -S11 (dB)

Gain(Power Gain) = S21 (dB)

Reverse Isolation = -S12 (dB)

Output Return Loss = -S22 (dB)

TEST CONDITIONS: Icc = 60mA, Vd = 4.70V @Temperature = +85degC

FREQ	Gain	Isolation	Input Return Loss	Output Return Loss	Stability		FREQ	IP3 Output	1dB Comp. Output	Noise Figure
(MHz)	(dB)	(dB)	(dB)	(dB)	K	Delta	(MHz)	(dBm)	(dBm)	(dB)
50	12.28	16.22	30.17	26.86	1.10	0.63	50	32.85	18.19	3.60
100	12.23	16.19	31.25	26.44	1.10	0.63	100	32.74	18.15	3.79
150	12.18	16.18	30.18	25.27	1.10	0.63	150	32.87	18.14	3.68
200	12.13	16.14	28.91	23.85	1.10	0.63	200	32.17	18.07	3.61
250	12.07	16.08	27.89	22.50	1.10	0.63	250	31.79	18.05	3.72
300	12.00	16.02	26.51	21.48	1.10	0.63	300	31.42	17.80	3.98
350	11.92	15.94	25.57	20.46	1.10	0.63	350	31.26	17.76	3.88
400	11.84	15.86	24.61	19.45	1.10	0.63	400	30.77	17.84	3.80
450	11.74	15.77	23.70	18.59	1.09	0.63	450	30.38	17.57	3.88
500	11.64	15.67	22.63	17.84	1.09	0.63	500	29.93	17.43	3.99
550	11.54	15.57	21.86	17.05	1.09	0.63	550	29.48	17.21	4.01
600	11.42	15.44	20.80	16.44	1.08	0.63	600	28.98	17.28	3.96
650	11.30	15.34	20.07	15.81	1.08	0.63	650	28.54	17.18	4.00
700	11.17	15.22	19.39	15.22	1.08	0.63	700	28.16	17.12	4.18
750	11.03	15.10	18.49	14.68	1.08	0.63	750	27.70	16.97	4.25
800	10.91	15.00	17.88	14.20	1.07	0.63	800	27.17	16.77	4.27
850	10.75	14.87	17.25	13.75	1.07	0.63	850	26.83	16.61	4.20
900	10.61	14.75	16.63	13.35	1.07	0.63	900	26.46	16.57	4.31
950	10.45	14.65	16.06	12.94	1.07	0.62	940	26.20	16.29	4.41
1000	10.31	14.54	15.52	12.60	1.06	0.62	1000	25.79	16.06	4.41
1100	9.98	14.31	14.50	11.97	1.06	0.62	1050	25.49	15.91	4.38
1200	9.67	14.09	13.58	11.47	1.06	0.62	1100	25.19	15.63	4.45
1400	9.00	13.72	12.00	10.65	1.05	0.61	1150	24.99	15.47	4.64
1600	8.30	13.41	10.72	10.07	1.06	0.60	1200	24.77	15.34	4.65
1800	7.63	13.15	9.65	9.66	1.07	0.59	1250	24.41	15.18	4.58
2000	6.99	12.90	8.77	9.46	1.07	0.58	1300	24.13	14.91	4.78
2200	6.36	12.74	8.08	9.34	1.09	0.56	1350	23.90	14.69	4.90
2400	5.69	12.61	7.34	9.18	1.10	0.55	1400	23.89	14.66	4.81
2600	5.04	12.60	6.85	9.19	1.13	0.52	1450	23.74	14.58	4.85
2800	4.50	12.47	6.26	9.10	1.13	0.52	1500	23.56	14.36	5.05
3000	3.94	12.37	5.75	8.96	1.14	0.51	1550	23.47	14.27	5.21
3200	3.35	12.39	5.31	8.93	1.16	0.49	1600	23.31	14.05	5.34
3400	2.78	12.36	4.85	8.66	1.16	0.48	1650	23.27	14.02	5.31
3600	2.24	12.38	4.48	8.54	1.17	0.47	1700	22.91	13.97	5.35
3800	1.67	12.39	4.10	8.33	1.17	0.47	1750	22.70	13.78	5.46
4000	1.10	12.41	3.77	8.06	1.17	0.46	1800	22.42	13.67	5.59
4500	-0.23	12.39	3.18	7.38	1.15	0.45	1850	22.34	13.44	5.47
5000	-1.48	12.27	2.84	6.66	1.13	0.45	1900	22.32	13.37	5.47
5500	-2.64	12.05	2.70	6.00	1.12	0.45	1950	21.99	13.16	5.72
6000	-3.83	11.81	2.61	5.42	1.14	0.46	2000	22.08	13.26	5.84

REV. X1

MAV-11SM+

120125

Page 7 of 11



IF/RF MICROWAVE COMPONENTS • ISO 9001 ISO 14001 AS 9100 CERTIFIED • RoHS compliant

P.O. Box 350166, Brooklyn, New York 11235-0003 (718) 934-4500 Fax (718) 332-4661



The Design Engineers Search Engine finds the model you need, Instantly • For detailed performance specs & shopping online see



MMIC Amplifier

MAV-11SM+

Typical Performance Data

Definitions:

Input Return Loss = -S11 (dB)

Gain(Power Gain) = S21 (dB)

Reverse Isolation = -S12 (dB)

Output Return Loss = -S22 (dB)

TEST CONDITIONS: Icc = 48mA, Vd = 4.48V @Temperature = +85degC

FREQ	Gain	Isolation	Input Return Loss	Output Return Loss	Stability		FREQ	IP3 Output	1dB Comp. Output	Noise Figure
(MHz)	(dB)	(dB)	(dB)	(dB)	K	Delta	(MHz)	(dBm)	(dBm)	(dB)
50	12.19	16.11	30.64	28.39	1.10	0.64	50	31.46	16.13	3.52
100	12.13	16.11	32.83	28.19	1.10	0.63	100	31.41	16.09	3.74
150	12.08	16.10	31.31	26.60	1.11	0.63	150	31.85	16.16	3.61
200	12.03	16.06	29.88	24.84	1.11	0.63	200	31.27	15.98	3.57
250	11.98	15.98	28.34	23.17	1.10	0.63	250	30.67	15.97	3.66
300	11.90	15.93	26.76	21.98	1.10	0.63	300	31.05	15.82	3.96
350	11.82	15.85	25.67	20.84	1.10	0.63	350	30.93	15.84	3.84
400	11.73	15.78	24.63	19.77	1.10	0.62	400	30.64	16.18	3.77
450	11.64	15.69	23.66	18.82	1.09	0.62	450	30.30	15.86	3.81
500	11.54	15.59	22.56	18.05	1.09	0.62	500	30.25	15.86	3.94
550	11.43	15.47	21.75	17.24	1.09	0.62	550	29.96	15.69	3.96
600	11.31	15.37	20.68	16.59	1.08	0.62	600	29.66	15.92	3.90
650	11.20	15.27	19.92	15.95	1.08	0.62	650	29.36	15.94	3.94
700	11.05	15.15	19.25	15.33	1.08	0.62	700	29.15	15.92	4.12
750	10.92	15.05	18.36	14.77	1.08	0.62	750	28.86	15.97	4.19
800	10.79	14.92	17.76	14.28	1.07	0.62	800	28.40	15.85	4.21
850	10.64	14.81	17.14	13.80	1.07	0.62	850	28.14	15.93	4.16
900	10.50	14.70	16.53	13.39	1.07	0.62	900	27.86	15.99	4.26
950	10.34	14.60	15.97	12.97	1.07	0.62	940	27.63	15.83	4.36
1000	10.18	14.48	15.45	12.62	1.06	0.62	1000	27.23	15.74	4.35
1100	9.87	14.25	14.46	11.95	1.06	0.62	1050	26.96	15.76	4.32
1200	9.56	14.04	13.56	11.43	1.06	0.61	1100	26.62	15.60	4.40
1400	8.90	13.66	12.04	10.52	1.05	0.61	1150	26.45	15.48	4.57
1600	8.22	13.34	10.80	9.88	1.06	0.60	1200	26.26	15.40	4.59
1800	7.57	13.06	9.78	9.39	1.06	0.59	1250	25.92	15.32	4.52
2000	6.96	12.79	8.95	9.11	1.06	0.58	1300	25.58	15.13	4.72
2200	6.34	12.61	8.25	8.91	1.08	0.57	1350	25.34	14.96	4.83
2400	5.71	12.44	7.54	8.69	1.09	0.56	1400	25.30	14.97	4.74
2600	5.09	12.42	7.05	8.63	1.12	0.54	1450	25.17	14.91	4.80
2800	4.56	12.26	6.45	8.50	1.12	0.54	1500	24.92	14.76	5.01
3000	4.02	12.16	5.95	8.31	1.12	0.53	1550	24.88	14.67	5.14
3200	3.47	12.17	5.52	8.28	1.14	0.52	1600	24.72	14.44	5.27
3400	2.90	12.13	5.04	8.00	1.14	0.51	1650	24.68	14.47	5.26
3600	2.40	12.16	4.65	7.90	1.15	0.50	1700	24.31	14.42	5.30
3800	1.84	12.19	4.25	7.70	1.15	0.49	1750	24.13	14.31	5.39
4000	1.29	12.21	3.93	7.50	1.15	0.49	1800	23.77	14.13	5.49
4500	0.03	12.25	3.30	7.00	1.14	0.48	1850	23.67	13.97	5.38
5000	-1.15	12.20	2.95	6.49	1.13	0.47	1900	23.66	13.91	5.42
5500	-2.25	12.04	2.81	6.00	1.13	0.46	1950	23.28	13.69	5.65
6000	-3.37	11.84	2.71	5.55	1.14	0.46	2000	23.33	13.86	5.79

REV. X1

MAV-11SM+

120125

Page 8 of 11



IF/RF MICROWAVE COMPONENTS • ISO 9001 ISO 14001 AS 9100 CERTIFIED • RoHS compliant

P.O. Box 350166, Brooklyn, New York 11235-0003 (718) 934-4500 Fax (718) 332-4661



The Design Engineers Search Engine finds the model you need, Instantly • For detailed performance specs & shopping online see



MMIC Amplifier

MAV-11SM+

Typical Performance Data

Definitions:

Input Return Loss = -S11 (dB)

Gain(Power Gain) = S21 (dB)

Reverse Isolation = -S12 (dB)

Output Return Loss = -S22 (dB)

TEST CONDITIONS: Icc = 72mA, Vd = 4.92V @Temperature = +85degC

FREQ	Gain	Isolation	Input Return Loss	Output Return Loss	Stability		FREQ	IP3 Output	1dB Comp. Output	Noise Figure
					K	Delta				
(MHz)	(dB)	(dB)	(dB)	(dB)	K	Delta	(MHz)	(dBm)	(dBm)	(dB)
50	12.31	16.29	29.22	25.47	1.10	0.63	50	35.74	19.60	3.65
100	12.25	16.24	30.12	25.13	1.10	0.63	100	35.33	19.58	3.87
150	12.22	16.24	29.36	24.14	1.11	0.63	150	34.72	19.51	3.74
200	12.17	16.18	28.47	23.03	1.10	0.63	200	33.68	19.41	3.67
250	12.12	16.13	27.75	21.85	1.10	0.63	250	33.32	19.15	3.78
300	12.04	16.08	26.65	21.00	1.10	0.63	300	31.95	18.78	4.07
350	11.97	15.99	25.95	20.11	1.10	0.63	350	31.65	18.61	3.96
400	11.89	15.90	25.08	19.20	1.10	0.63	400	30.96	18.52	3.86
450	11.81	15.80	24.23	18.39	1.09	0.63	450	30.47	18.19	3.93
500	11.71	15.70	23.15	17.70	1.09	0.63	500	29.81	17.96	4.05
550	11.60	15.59	22.40	16.96	1.09	0.63	550	29.24	17.64	4.08
600	11.49	15.48	21.27	16.36	1.08	0.63	600	28.61	17.51	4.01
650	11.37	15.37	20.51	15.77	1.08	0.63	650	28.06	17.23	4.06
700	11.24	15.24	19.77	15.18	1.08	0.63	700	27.61	17.11	4.24
750	11.11	15.12	18.83	14.67	1.07	0.63	750	27.06	16.77	4.29
800	10.98	15.00	18.15	14.22	1.07	0.63	800	26.51	16.46	4.32
850	10.83	14.89	17.45	13.80	1.07	0.63	850	26.13	16.22	4.28
900	10.69	14.76	16.78	13.43	1.06	0.63	900	25.73	16.12	4.37
950	10.53	14.66	16.18	13.04	1.06	0.63	940	25.42	15.77	4.48
1000	10.37	14.54	15.55	12.73	1.06	0.63	1000	24.96	15.50	4.50
1100	10.04	14.31	14.43	12.16	1.06	0.62	1050	24.70	15.26	4.45
1200	9.70	14.12	13.42	11.72	1.06	0.62	1100	24.37	14.97	4.52
1400	8.99	13.77	11.69	11.02	1.06	0.61	1150	24.19	14.77	4.71
1600	8.24	13.50	10.33	10.58	1.07	0.59	1200	23.93	14.60	4.75
1800	7.52	13.28	9.23	10.30	1.08	0.57	1250	23.59	14.37	4.63
2000	6.82	13.09	8.32	10.26	1.09	0.55	1300	23.28	14.10	4.83
2200	6.13	12.98	7.61	10.24	1.11	0.53	1350	23.07	13.86	4.98
2400	5.43	12.86	6.89	10.18	1.13	0.51	1400	23.02	13.82	4.91
2600	4.73	12.90	6.42	10.23	1.17	0.48	1450	22.88	13.68	4.92
2800	4.14	12.79	5.87	10.18	1.17	0.47	1500	22.70	13.47	5.14
3000	3.55	12.69	5.37	10.00	1.17	0.46	1550	22.67	13.35	5.32
3200	2.94	12.71	4.97	9.97	1.20	0.44	1600	22.49	13.15	5.43
3400	2.32	12.66	4.53	9.58	1.20	0.44	1650	22.47	13.11	5.42
3600	1.75	12.65	4.18	9.38	1.20	0.43	1700	22.08	13.00	5.43
3800	1.16	12.64	3.83	9.02	1.20	0.42	1750	21.91	12.86	5.59
4000	0.55	12.61	3.54	8.62	1.19	0.42	1800	21.63	12.66	5.69
4500	-0.85	12.50	2.97	7.58	1.16	0.42	1850	21.54	12.49	5.58
5000	-2.15	12.28	2.69	6.58	1.14	0.44	1900	21.49	12.41	5.56
5500	-3.38	11.98	2.58	5.74	1.13	0.45	1950	21.23	12.23	5.84
6000	-4.61	11.70	2.52	5.09	1.15	0.47	2000	21.28	12.34	5.99

REV. X1
MAV-11SM+
120125
Page 9 of 11



IF/RF MICROWAVE COMPONENTS • ISO 9001 ISO 14001 AS 9100 CERTIFIED RoHS compliant
P.O. Box 350166, Brooklyn, New York 11235-0003 (718) 934-4500 Fax (718) 332-4661



The Design Engineers Search Engine finds the model you need, Instantly • For detailed performance specs & shopping online see



Typical Performance Curves

GAIN vs. TEMPERATURE

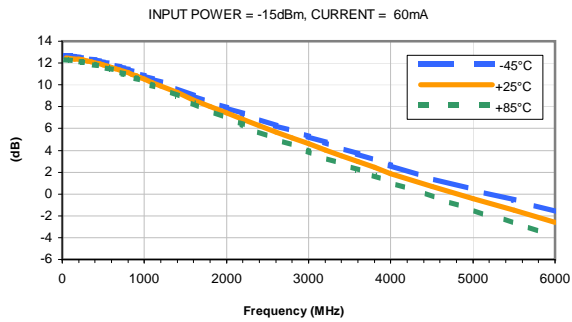

GAIN vs. CURRENT

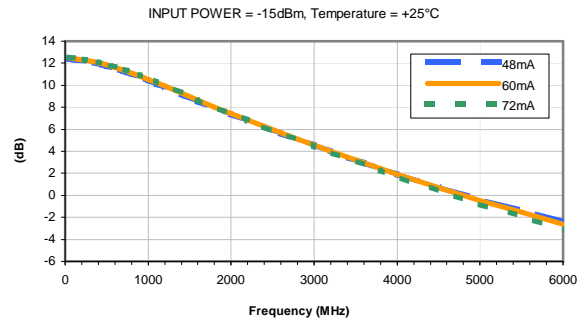

ISOLATION vs. TEMPERATURE

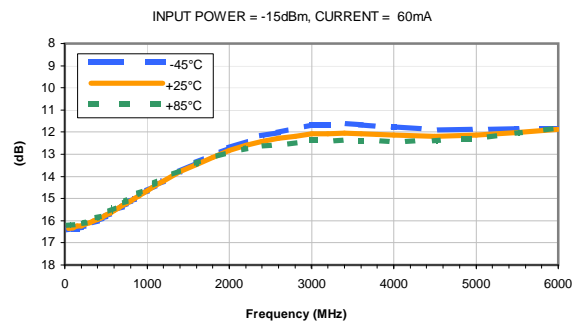

ISOLATION vs. CURRENT

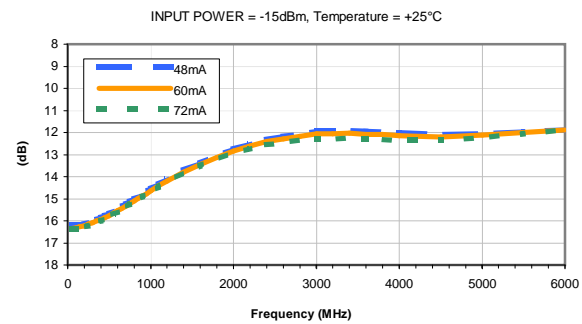

INPUT RETURN LOSS vs. TEMPERATURE

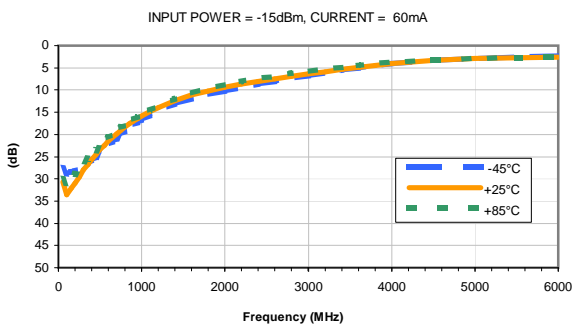

INPUT RETURN LOSS vs. CURRENT

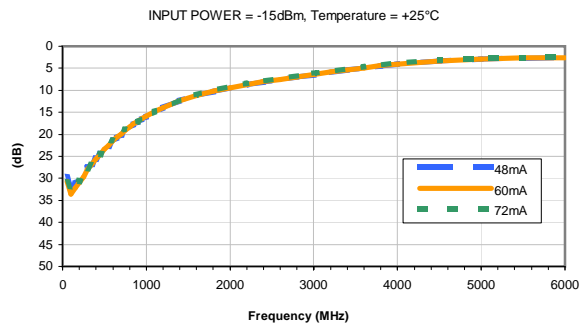

OUTPUT RETURN LOSS vs. TEMPERATURE

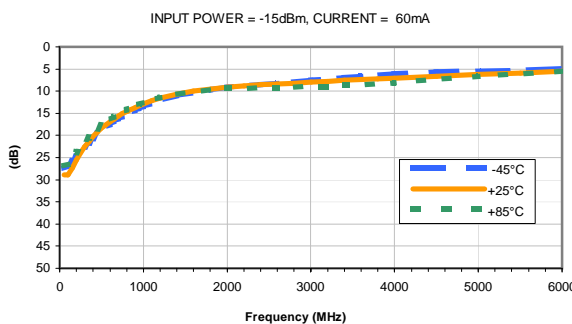

OUTPUT RETURN LOSS vs. CURRENT

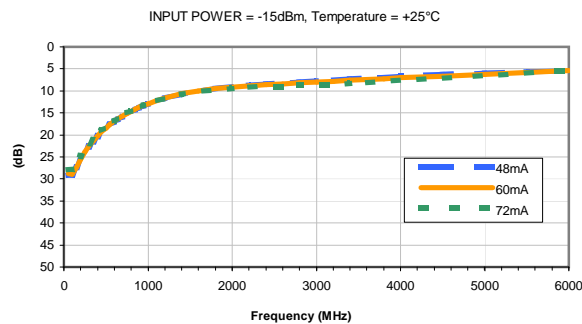

Typical Performance Curves

OUTPUT IP3 vs. TEMPERATURE

INPUT POWER = -15dBm, CURRENT = 60mA

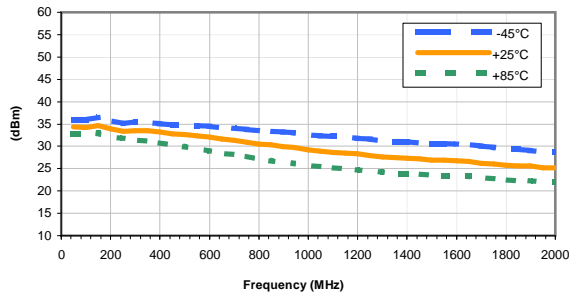

OUTPUT IP-3 vs. CURRENT

INPUT POWER = -15dBm, Temperature = +25°C

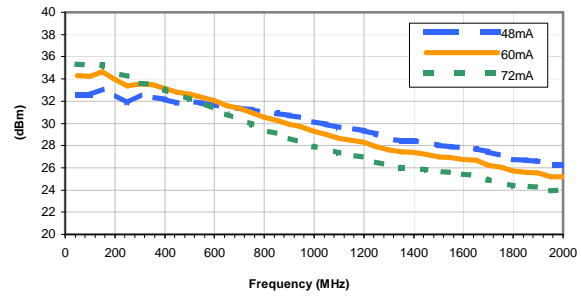

OUTPUT POWER at 1dB Compression vs. TEMPERATURE

CURRENT = 60mA

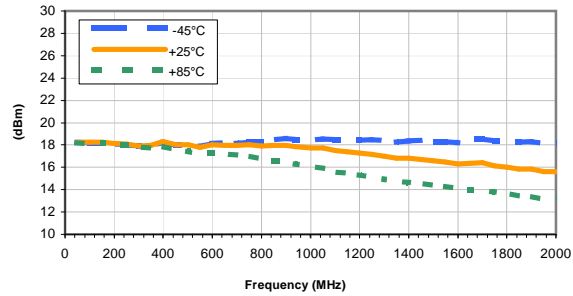

OUTPUT POWER at 1dB Compression vs. CURRENT

Temperature = +25°C

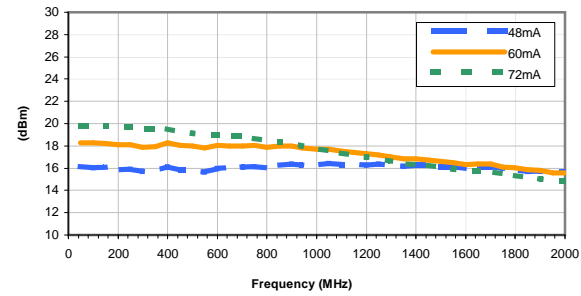

Noise Figure vs. TEMPERATURE

CURRENT = 60mA

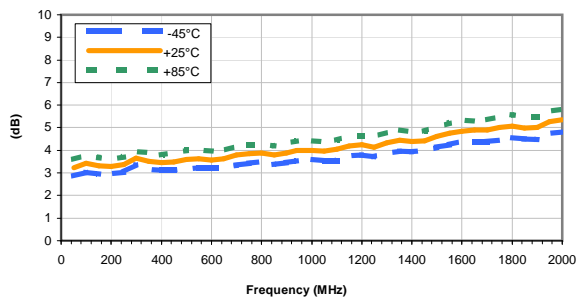

Noise Figure vs. CURRENT

Temperature = +25°C

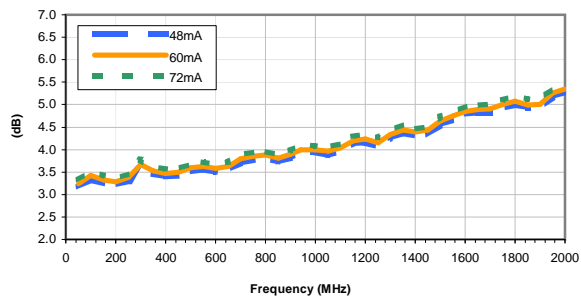

Typical Performance Curves

GAIN vs. TEMPERATURE

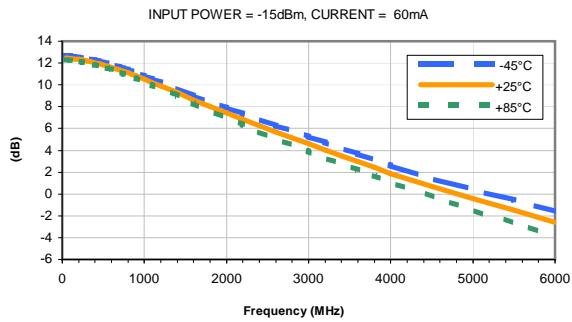

GAIN vs. CURRENT

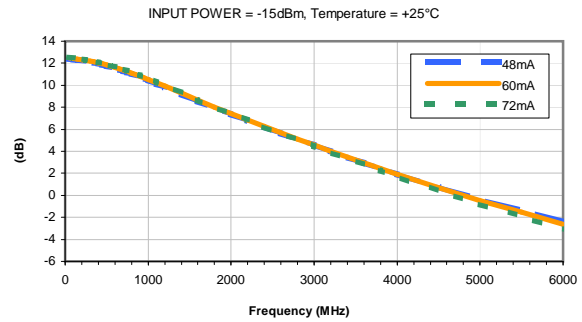

ISOLATION vs. TEMPERATURE

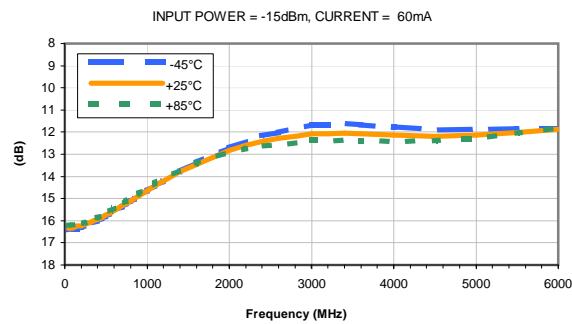

ISOLATION vs. CURRENT

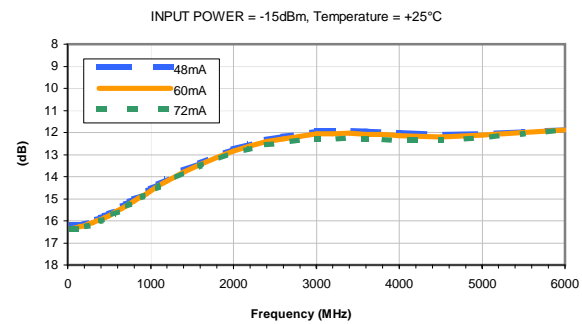

INPUT RETURN LOSS vs. TEMPERATURE

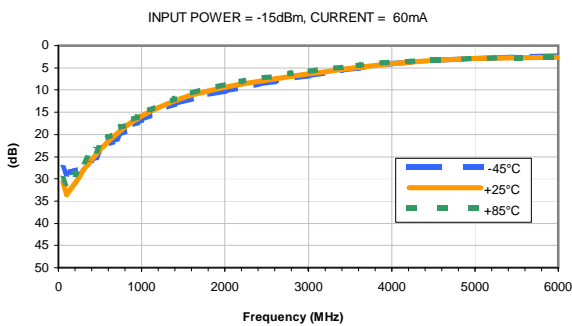

INPUT RETURN LOSS vs. CURRENT

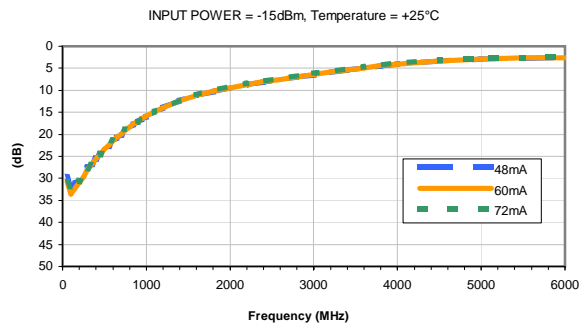

OUTPUT RETURN LOSS vs. TEMPERATURE

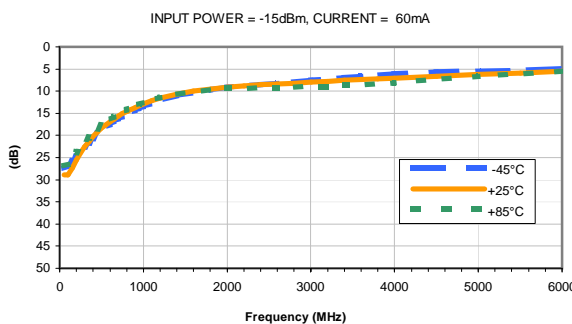

OUTPUT RETURN LOSS vs. CURRENT

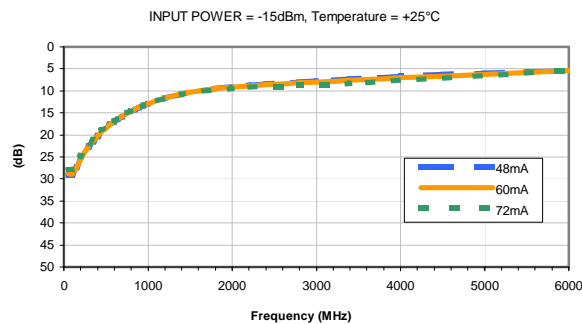

Typical Performance Curves

OUTPUT IP3 vs. TEMPERATURE

INPUT POWER = -15dBm, CURRENT = 60mA

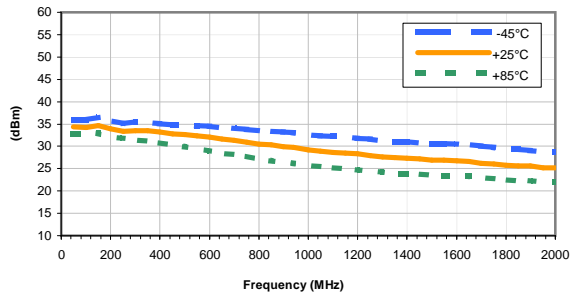

OUTPUT IP-3 vs. CURRENT

INPUT POWER = -15dBm, Temperature = +25°C

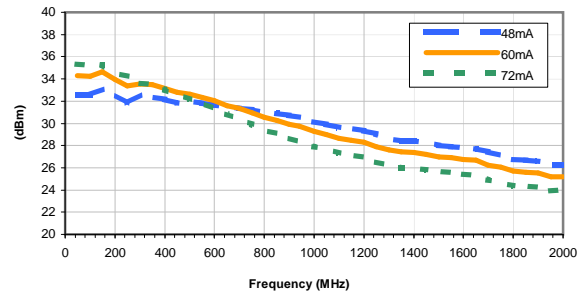

OUTPUT POWER at 1dB Compression vs. TEMPERATURE

CURRENT = 60mA

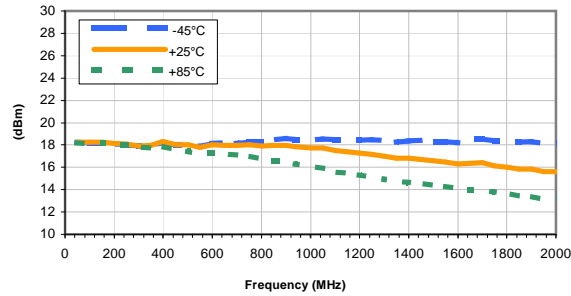

OUTPUT POWER at 1dB Compression vs. CURRENT

Temperature = +25°C

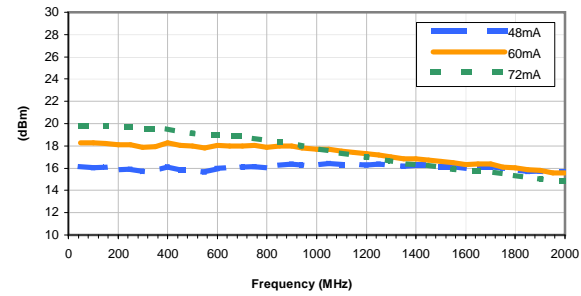

Noise Figure vs. TEMPERATURE

CURRENT = 60mA

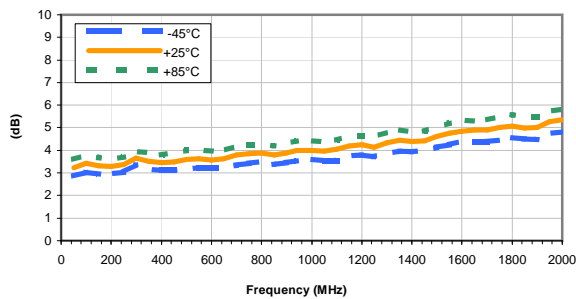

Noise Figure vs. CURRENT

Temperature = +25°C

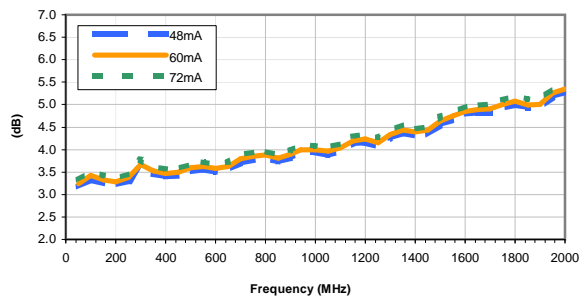

Outline Dimensions

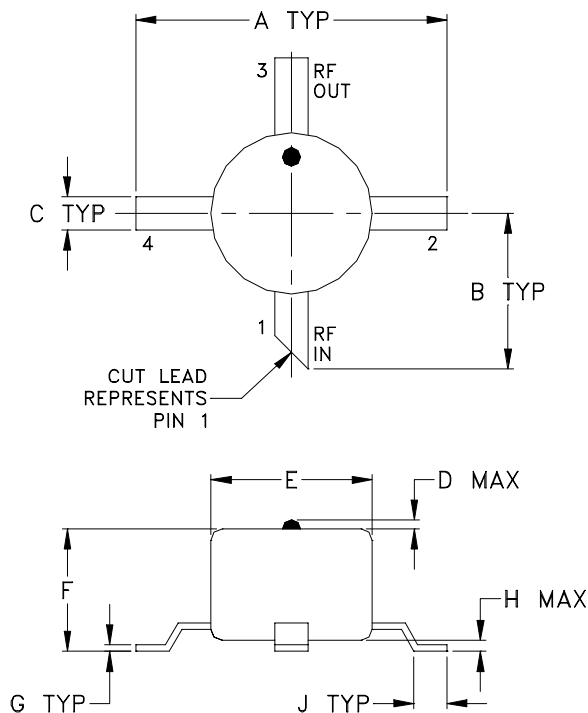

PCB Land Pattern

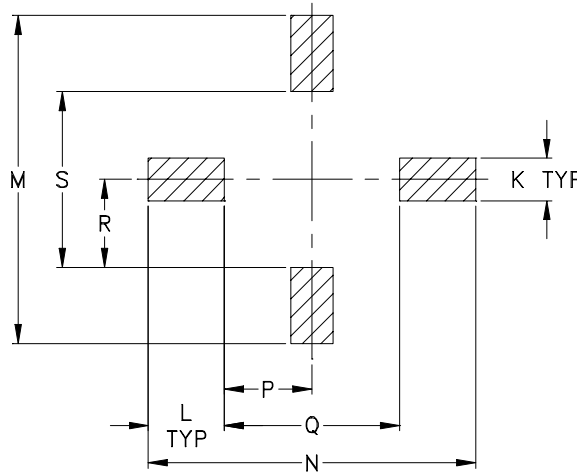

Suggested Layout,
Tolerance to be within $\pm .002$

CASE #	A	B	C	D	E	F	G	H	J	K	L	M	N
RRR137-1	.28 (7.11)	.14 (3.56)	.030 (.76)	.020 (0.51)	.145 (3.68)	.110 (2.79)	.007 (0.18)	.020 (0.51)	.03 (0.76)	.040 (1.02)	.072 (1.83)	.310 (7.87)	.310 (7.87)

CASE #	P	Q	R	S	WT. GRAM
RRR137-1	.084 (2.13)	.167 (4.24)	.084 (2.13)	.167 (4.24)	.015

Dimensions are in inches (mm). Tolerances: 2 Pl. $\pm .02$; 3 Pl. $\pm .015$

Notes:

1. Case material: Plastic.
2. Termination finish:
For RoHS Case Styles: Tin plate. All models, (+) suffix.
3. RF output is identified by index mark, model dash number by alphanumeric code.
4. Special Tolerances: Termination width $\pm .005$ inch, termination thickness $\pm .003$ inch.

Tape & Reel Packaging TR-F11

DEVICE ORIENTATION IN T&R EXCEPT MAV-11SM

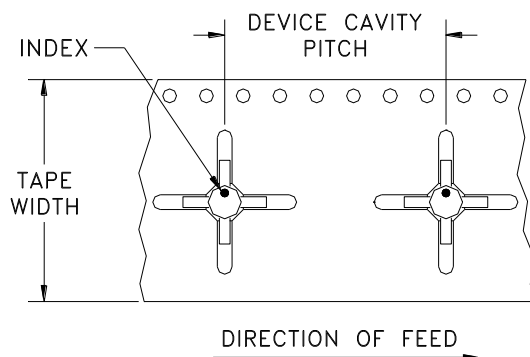

Applicable Case Styles
BBB123

Tape Width, mm	Device Cavity Pitch, mm	Reel Size, inches	Devices per Reel	
24	24	13	Small quantity standards (see note)	20
				50
				100
				200
			Standard	500

Note: Please Consult individual model data sheet to determine device per reel availability

DEVICE ORIENTATION IN T&R FOR MAV-11SM ONLY

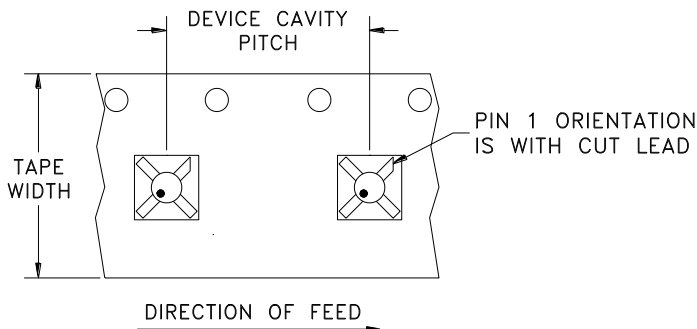

Tape Width, mm	Device Cavity Pitch, mm	Reel Size, inches	Devices per Reel	
12	8	7	Small quantity standards (see note)	20
				50
				100
				200
			Standard	500

Note: Please Consult individual model data sheet to determine device per reel availability

Mini-Circuits carrier tape materials provide protection from ESD (Electro-Static Discharge) during handling and transportation. Tapes are static dissipative and comply with industry standards EIA-481/EIA-541.

Go to: www.minicircuits.com/pages/pdfs/tape.pdf



INTERNET <http://www.minicircuits.com>

P.O. Box 350166, Brooklyn, New York 11235-0003 (718) 934-4500 Fax (718) 332-4661

Distribution Centers NORTH AMERICA 800-654-7949 • 417-335-5935 • Fax 417-335-5945 • EUROPE 44-1252-832600 • Fax 44-1252-837010

Mini-Circuits ISO 9001 & ISO 14001 Certified

THIRD ANGLE PROJECTION

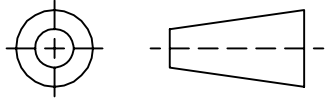

REVISIONS

REV	ECN No.	DESCRIPTION	DATE	DR	AUTH
OR	M94379	NEW RELEASE	09/22/05	AV	MM
A	M102713	ADDED "...WITH SMOBC"	01/12/06	GF	IL
B	M108434	UPDATED DRAWING PER TB-412+	11/14/06	PW	IG

SUGGESTED MOUNTING CONFIGURATION FOR
DH820/RRR137 CASE STYLES, "cb" PIN CONNECTION

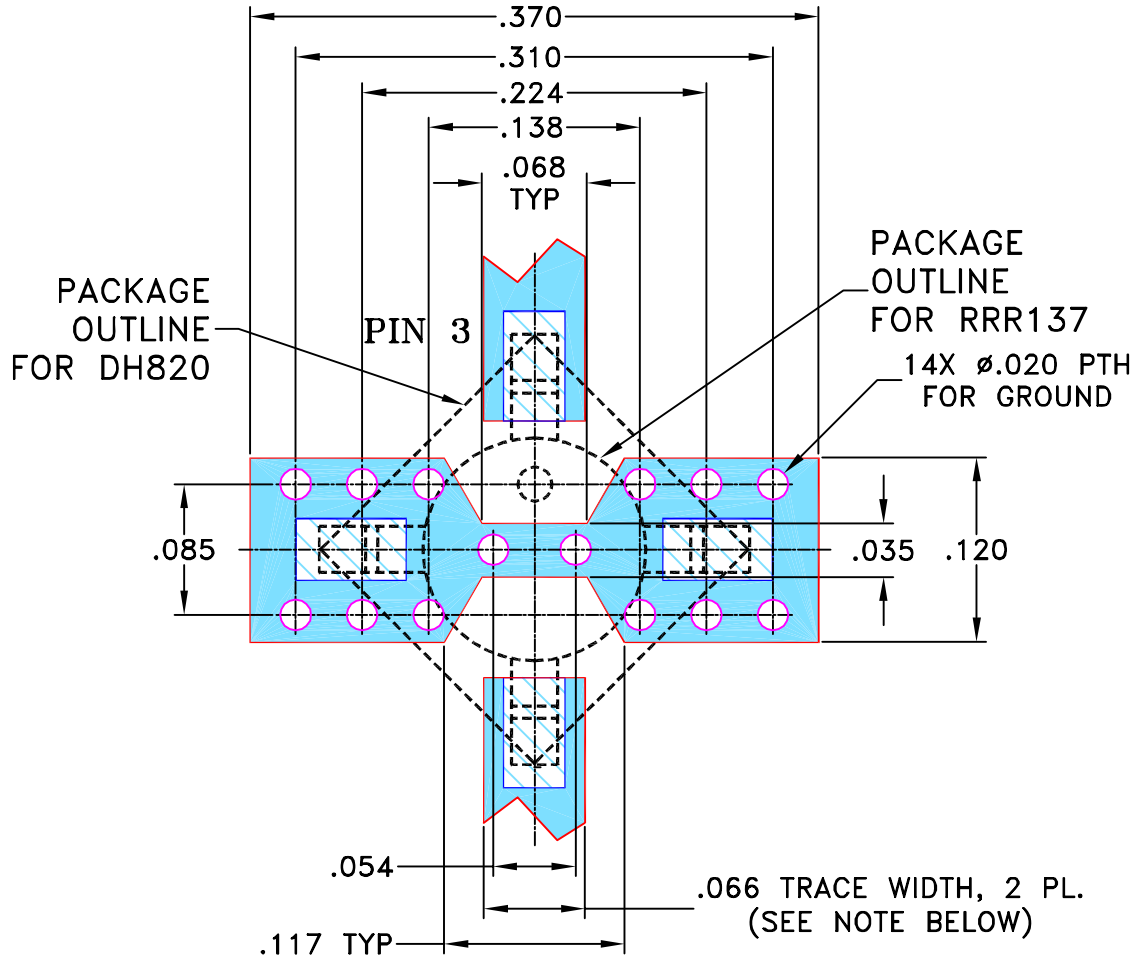

- NOTE: 1. TRACE WIDTH IS SHOWN FOR ROGERS RO4350B WITH DIELECTRIC THICKNESS $.030'' \pm .002''$; COPPER: 1/2 OZ. EACH SIDE. FOR OTHER MATERIALS TRACE WIDTH MAY NEED TO BE MODIFIED.
2. BOTTOM SIDE OF THE PCB IS CONTINUOUS GROUND PLANE.



DENOTES PCB COPPER LAYOUT WITH SMOBC (SOLDER MASK OVER BARE COPPER)



DENOTES COPPER LAND PATTERN FREE OF SOLDER MASK

UNLESS OTHERWISE SPECIFIED

INITIALS

DATE

DIMENSIONS ARE IN INCHES

DRAWN

AV

09/16/04

TOLERANCES ON:

CHECKED

IL

09/22/05

2 PL DECIMALS \pm

APPROVED

MM

09/22/05

3 PL DECIMALS \pm .005

ANGLES \pm

FRACTIONS \pm

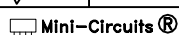

THIS DOCUMENT AND ITS CONTENTS ARE THE PROPERTY OF MINI-CIRCUITS. EXCEPT FOR USE EXPRESSLY GRANTED, IN WRITING, TO ITS VENDORS, VENDEE AND THE UNITED STATES GOVERNMENT, MINI-CIRCUITS RESERVES ALL PROPRIETARY DESIGN, USE, MANUFACTURING AND REPRODUCTION RIGHTS THERETO. THESE CONTENTS SHALL NOT BE USED, DUPLICATED OR DISCLOSED TO ANY OUTSIDE PARTY, IN WHOLE OR IN PART, WITHOUT WRITTEN PERMISSION OF MINI-CIRCUITS.



Mini-Circuits®

13 Neptune Avenue
Brooklyn NY 11235

PL, cb, DH820/RRR137, MAV, TB-412-XXX+

SIZE

CODE IDENT

DRAWING NO:

REV:

A

15542

98-PL-169

B

FILE: 98PL169

SCALE:

8:1

SHEET:

1 OF 1

ASHEETA1.DWG REV:A DATE:01/12/95

Evaluation Board and Circuit

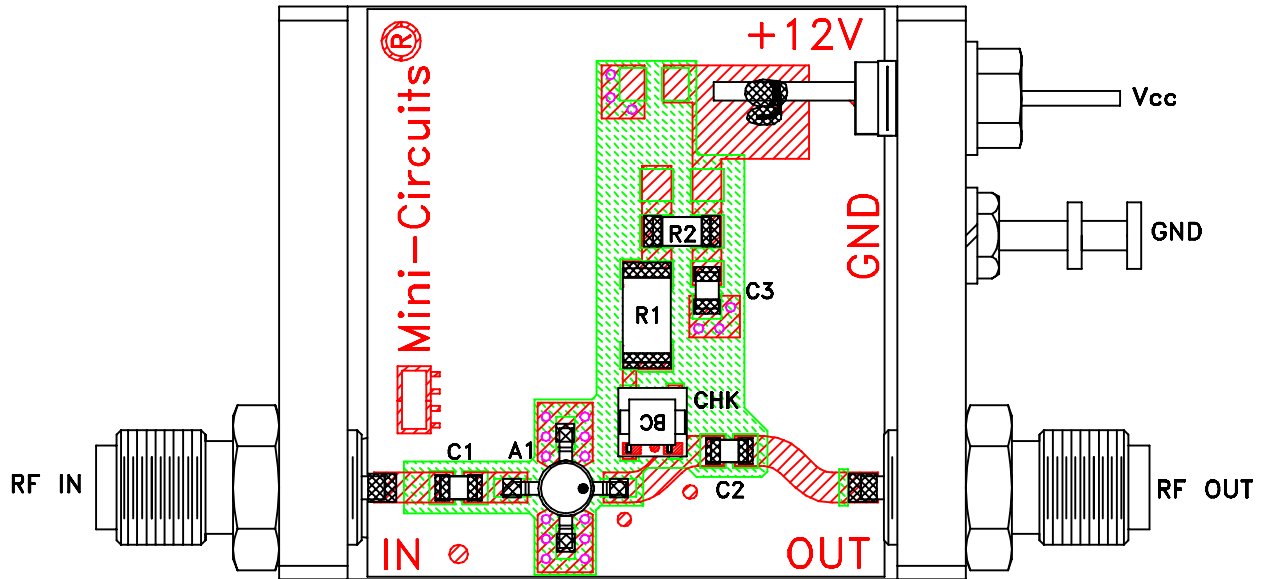

TB-412-11+

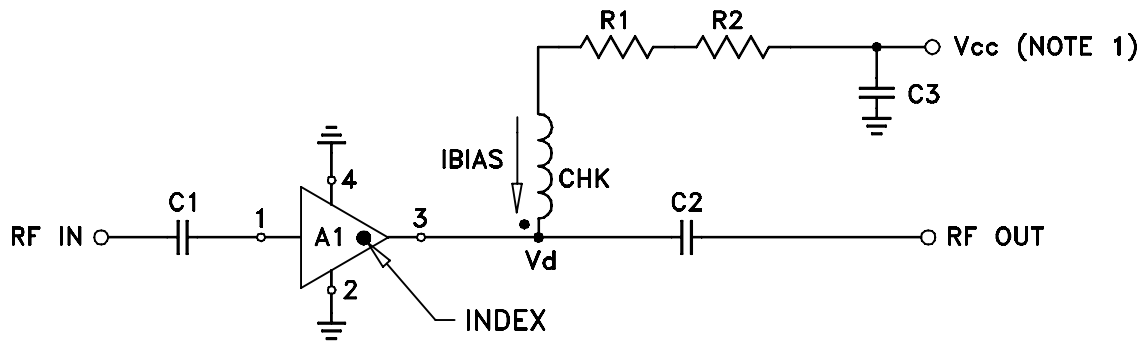

COMPONENT	VALUE
A1	MAV-11SM(+)
C1 (NOTE 4)	2400 pF
C2 (NOTE 4)	2400 pF
C3 (bypass)	0.1 uF
R1	100 Ohms, 0.75W
R2	8.25 Ohms, 0.25W
CHK	Mini-Circuits TCCH-80+

Schematic Diagram

NOTE:

1. Vcc voltage: $+12 \pm 0.2V$.
2. SMA Female connectors.
3. PCB material: Rogers RO4350 or equivalent, dielectric constant=3.5, dielectric thickness=.030 inch.
4. Capacitors, C1 & C2 should be free of resonance up to the highest frequency specified.

 **Mini-Circuits®**

All Mini-Circuits products are manufactured under exacting quality assurance and control standards, and are capable of meeting published specifications after being subjected to any or all of the following physical and environmental test.

Specification	Test/Inspection Condition	Reference/Spec
Operating Temperature	-20° to 85°C Ambient Environment	Individual Model Data Sheet
Storage Temperature	-55° to 100° C Ambient Environment	Individual Model Data Sheet
Thermal Shock	-55° to 100°C, 100 cycles	MIL-STD-202, Method 107, Condition A-3, except +100°C
Mechanical Shock	1.5Kg, 0.5 ms, 5 shock pulses, Y1 direction only	MIL-STD-883, Method 2002, Condition B, except Y1 direction only
Vibration (Variable Frequency)	50g peak	MIL-STD-883, Method 2007, Condition B
Autoclave	15 psig, 100% RH, 121°C, 96 hours	JESD22-A102, Condition C
HAST	130°C, 85% RH, 96 hours	JESD22-A110
Solderability	10X Magnification	J-STD-002, Para 4.2.5, Test S, 95% Coverage
Solder Reflow Heat	Sn-Pb Eutetic Process: 240°C peak Pb-Free Process: 260°C peak	J-STD-020, Table 4-1, 4-2 and 5-2; Figure 5-1
Moisture Sensitivity: Level 1	Bake at 125°C for 24 hours Soak at 85°C/85% RH for 168 hours, Reflow 3 cycles at 260°C peak	J-STD-020
Marking Resistance to Solvents	Isopropyl alcohol + mineral spirits at 25°C; terpene defluxer at 25°C; distilled water + proylene glycol monomethyl ether +	MIL-STD-202, Method 215

All Mini-Circuits products are manufactured under exacting quality assurance and control standards, and are capable of meeting published specifications after being subjected to any or all of the following physical and environmental test.

Specification	Test/Inspection Condition	Reference/Spec
	monoethanolamine at 63°C to 70°C	