

High IP3

Frequency Mixer

NON-CATALOG

SYM-10DH

Level 17 (LO Power +17 dBm) 800 to 1000 MHz

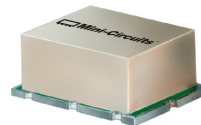

CASE STYLE: TTT167

Maximum Ratings

Operating Temperature	-40°C to 85°C
Storage Temperature	-55°C to 100°C
RF Power	200mW
IF Current	40mA

Permanent damage may occur if any of these limits are exceeded.

Pin Connections

LO	2
RF	1
IF	3
GROUND	4,5,6

Outline Drawing

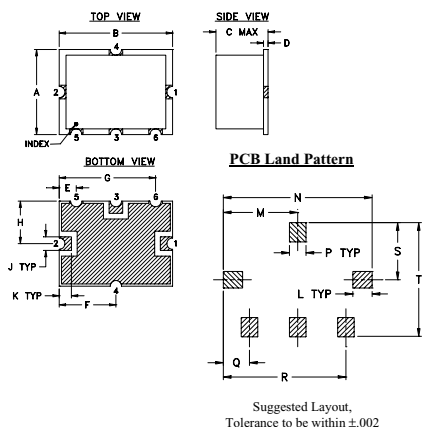

Outline Dimensions (inch/mm)

A	B	C	D	E	F	G	H	J	K
.38	.50	.23	.020	.075	.250	.425	.187	.050	.050
9.65	12.70	5.84	0.51	1.91	6.35	10.80	4.75	1.27	1.27
L	M	N	P	Q	R	S	T	wt.	
.070	.270	.540	.060	.095	.445	.208	.415		grams
1.78	6.86	13.72	1.52	2.41	11.30	5.28	10.54		0.8

Demo Board MCL P/N: TB-12 Suggested PCB Layout (PL-079)

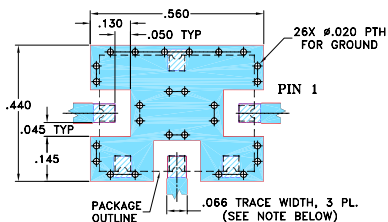

NOTE:

- TRACE WIDTH IS SHOWN FOR ROGERS R04350B WITH DIELECTRIC THICKNESS .030" ± .002"; COPPER: 1/2 OZ. EACH SIDE. FOR OTHER MATERIALS TRACE WIDTH MAY NEED TO BE MODIFIED.
- THE USE OF SOLDER MASK OVER THE GROUND AREA UNDER THE UNIT AS SHOWN IS RECOMMENDED TO PREVENT POTENTIAL SHORTING. IF USER CHOOSES TO EXPOSE METAL UNDER THE ENTIRE UNIT GROUND PAD FOR IMPROVED GROUNDING, IT IS RECOMMENDED A SOLDER MASK DAM BE APPLIED AROUND EACH GROUND PAD TO ENSURE FILLET AND CONNECTION AT GROUND PADS.
- BOTTOM SIDE OF THE PCB IS CONTINUOUS GROUND PLANE. DENOTES PCB COPPER LAYOUT WITH SMOBC (SOLDER MASK OVER BARE COPPER). SEE NOTE 2.
DENOTES COPPER LAND PATTERN FREE OF SOLDER MASK

Notes

- Performance and quality attributes and conditions not expressly stated in this specification document are intended to be excluded and do not form a part of this specification document.
- Electrical specifications and performance data contained in this specification document are based on Mini-Circuit's applicable established test performance criteria and measurement instructions.
- The parts covered by this specification document are subject to Mini-Circuits standard limited warranty and terms and conditions (collectively, "Standard Terms"); Purchasers of this part are entitled to the rights and benefits contained therein. For a full statement of the Standard Terms and the exclusive rights and remedies thereunder, please visit Mini-Circuits' website at www.minicircuits.com/MCLStore/terms.jsp

Features

- low conversion loss, 7.6 dB typ.
- excellent L-R isolation, 45 dB typ. & L-I isolation, 29 dB typ.
- high IP3, 31 dBm typ.
- excellent LO & RF VSWR, 1.32:1 typ. excellent IF VSWR, 1.1:1 typ.

Applications

- cellular
- ISM/SMR/GSM

Electrical Specifications

FREQUENCY (MHz)	CONVERSION LOSS (dB)	LO-RF ISOLATION (dB)	LO-IF ISOLATION (dB)	IP3 at center band (dBm)
LO/RF $f_L - f_U$	IF \bar{X}	Total Range Max.	Typ. Min.	Typ. Min.
800-1000	20-200	7.6	9.3	45 34
1 dB COMP.: +14 dBm typ.				

Typical Performance Data

Frequency (MHz)		Conversion Loss (dB)	Isolation L-R (dB)	Isolation L-I (dB)	VSWR RF Port (:1)	VSWR LO Port (:1)
RF	LO	LO +17dBm	LO +17dBm	LO +17dBm	LO +17dBm	LO +17dBm
800.10	801.10	7.45	41.49	30.20	1.29	1.22
810.63	811.63	7.48	41.53	30.14	1.29	1.21
821.15	822.15	7.50	41.50	30.05	1.30	1.20
831.68	832.68	7.49	41.42	30.01	1.31	1.20
842.21	843.21	7.48	41.37	29.94	1.32	1.20
852.73	853.73	7.46	41.31	29.89	1.33	1.21
863.26	864.26	7.52	41.41	29.88	1.34	1.21
873.78	874.78	7.59	41.44	29.78	1.35	1.21
884.31	885.31	7.68	41.41	29.71	1.35	1.20
894.84	895.84	7.76	41.43	29.74	1.36	1.19
905.36	906.36	7.82	41.42	29.74	1.36	1.18
915.89	916.89	7.84	41.16	29.61	1.37	1.17
926.42	927.42	7.85	40.86	29.53	1.38	1.17
936.94	937.94	7.86	40.49	29.43	1.40	1.17
947.47	948.47	7.90	40.18	29.32	1.41	1.17
958.00	959.00	7.95	40.09	29.25	1.42	1.17
968.52	969.52	8.04	40.04	29.19	1.43	1.17
979.05	980.05	8.14	40.07	29.08	1.44	1.15
989.57	990.57	8.25	40.13	29.03	1.45	1.14
1000.10	1001.10	8.35	40.12	29.02	1.46	1.13

Electrical Schematic

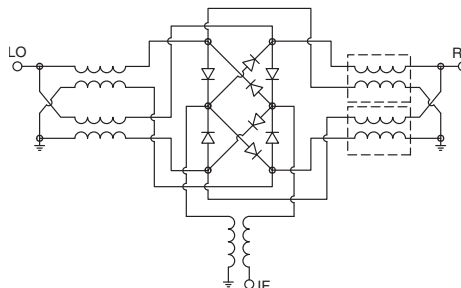

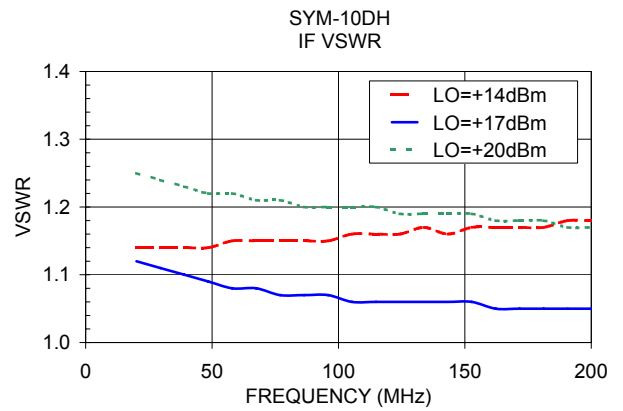
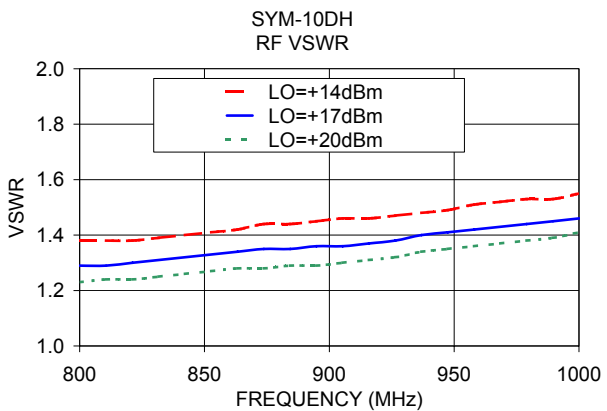
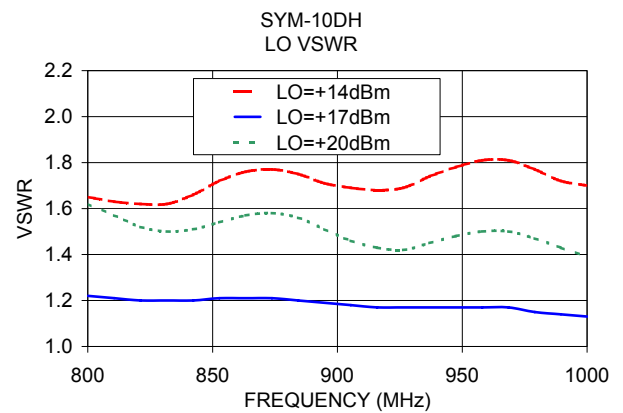
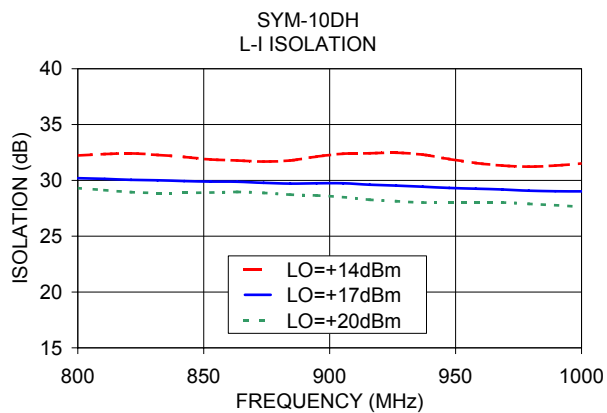
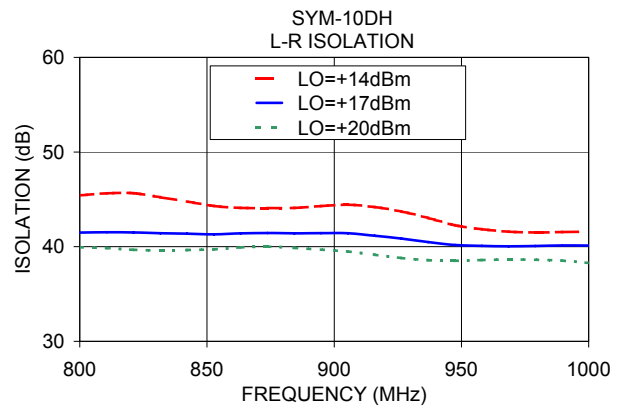
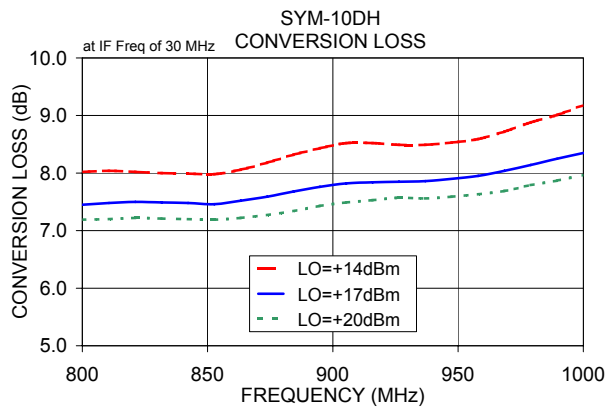

Notes

- A. Performance and quality attributes and conditions not expressly stated in this specification document are intended to be excluded and do not form a part of this specification document.
- B. Electrical specifications and performance data contained in this specification document are based on Mini-Circuit's applicable established test performance criteria and measurement instructions.
- C. The parts covered by this specification document are subject to Mini-Circuit's standard limited warranty and terms and conditions (collectively, "Standard Terms"); Purchasers of this part are entitled to the rights and benefits contained therein. For a full statement of the Standard Terms and the exclusive rights and remedies thereunder, please visit Mini-Circuit's website at www.minicircuits.com/MCLStore/terms.jsp

Frequency Mixer

SYM-10DH+

Typical Performance Data

RF (IN) (MHz)	LO (MHz)	CONVERSION LOSS IF FIXED @IF(OUT)=30MHz (dB)			RF (IN) (MHz)	LO (MHz)	IP3 INPUT (dBm)			RF (IN) (MHz)	LO (MHz)	COMPRESSION @RF IN=+14dBm (dB)		
		@LO (dBm)					@LO (dBm)					@LO (dBm)		
		+14	+17	+20			+14	+17	+20			+14	+17	+20
10.1	40.1	7.31	6.89	6.66	10.1	40.1	29.57	28.98	28.17	10.1	40.1	0.59	0.27	0.15
70.8	100.8	7.15	6.78	6.60	70.8	100.8	30.16	27.28	28.30	70.8	100.8	0.64	0.31	0.17
131.6	161.6	7.26	6.85	6.66	131.6	161.6	25.44	26.05	27.86	131.6	161.6	0.62	0.31	0.16
192.3	222.3	7.36	6.92	6.72	192.3	222.3	25.08	26.62	25.96	192.3	222.3	0.69	0.29	0.16
253.0	283.0	7.42	7.01	6.78	253.0	283.0	24.18	25.06	24.54	253.0	283.0	0.64	0.29	0.16
313.8	343.8	7.45	7.04	6.81	313.8	343.8	24.41	23.92	24.78	313.8	343.8	0.61	0.31	0.15
374.5	404.5	7.66	7.16	6.87	374.5	404.5	22.85	22.49	24.05	374.5	404.5	0.57	0.31	0.14
435.2	465.2	7.79	7.24	6.96	435.2	465.2	22.27	22.22	25.35	435.2	465.2	0.59	0.27	0.13
496.0	526.0	7.93	7.35	7.06	496.0	526.0	22.38	24.46	28.78	496.0	526.0	0.57	0.25	0.13
556.7	586.7	8.01	7.39	7.11	556.7	586.7	20.77	21.96	25.77	556.7	586.7	0.64	0.24	0.15
617.4	647.4	8.12	7.45	7.16	617.4	647.4	21.09	22.63	26.53	617.4	647.4	0.65	0.24	0.14
678.1	708.1	8.18	7.46	7.21	678.1	708.1	20.83	23.86	28.15	678.1	708.1	0.55	0.21	0.13
738.9	768.9	8.11	7.47	7.23	738.9	768.9	20.35	25.68	31.74	738.9	768.9	0.55	0.22	0.13
799.6	829.6	8.15	7.56	7.29	799.6	829.6	21.57	27.94	37.86	799.6	829.6	0.54	0.25	0.15
860.3	890.3	8.38	7.70	7.37	860.3	890.3	23.88	29.63	37.26	860.3	890.3	0.42	0.22	0.17
921.1	951.1	8.70	7.93	7.59	921.1	951.1	25.35	29.97	34.86	921.1	951.1	0.39	0.25	0.21
981.8	1011.8	9.21	8.28	7.88	981.8	1011.8	24.23	28.45	31.84	981.8	1011.8	0.38	0.26	0.22
1042.5	1072.5	9.87	8.81	8.32	1042.5	1072.5	23.02	25.09	27.97	1042.5	1072.5	0.20	0.15	0.13
1103.3	1133.3	10.51	9.29	8.74	1103.3	1133.3	24.29	24.61	28.07	1103.3	1133.3	-0.07	-0.01	0.02
1164.0	1194.0	10.68	9.44	8.88	1164.0	1194.0	27.10	27.13	28.92	1164.0	1194.0	-0.41	-0.16	-0.06
1224.7	1254.7	10.58	9.40	8.80	1224.7	1254.7	32.68	29.40	32.32	1224.7	1254.7	-0.55	-0.23	-0.10
1285.5	1315.5	10.44	9.31	8.75	1285.5	1315.5	29.98	30.02	32.50	1285.5	1315.5	-0.46	-0.21	-0.08
1346.2	1376.2	10.58	9.28	8.71	1346.2	1376.2	27.11	35.21	30.51	1346.2	1376.2	-0.38	-0.13	-0.03
1406.9	1436.9	10.65	9.33	8.68	1406.9	1436.9	27.89	30.53	29.87	1406.9	1436.9	-0.37	-0.12	0.02
1467.7	1497.7	10.67	9.32	8.66	1467.7	1497.7	28.73	29.33	29.23	1467.7	1497.7	-0.18	-0.06	0.04
1528.4	1558.4	10.72	9.32	8.69	1528.4	1558.4	28.03	29.37	28.80	1528.4	1558.4	-0.12	-0.01	0.07
1589.1	1619.1	10.78	9.35	8.69	1589.1	1619.1	27.26	27.40	27.03	1589.1	1619.1	-0.07	-0.01	0.08
1649.9	1679.9	10.72	9.28	8.68	1649.9	1679.9	25.72	27.42	26.72	1649.9	1679.9	0.06	0.04	0.08
1730.8	1760.8	10.60	9.19	8.67	1730.8	1760.8	24.83	26.27	25.62	1730.8	1760.8	0.20	0.14	0.11
1791.6	1821.6	10.58	9.15	8.68	1791.6	1821.6	24.12	25.93	25.56	1791.6	1821.6	0.38	0.21	0.15
1872.5	1902.5	10.45	9.00	8.60	1872.5	1902.5	25.56	26.07	25.62	1872.5	1902.5	0.48	0.27	0.20
1933.3	1963.3	10.30	8.95	8.59	1933.3	1963.3	26.06	26.20	25.94	1933.3	1963.3	0.59	0.34	0.24
2014.2	2044.2	10.16	8.91	8.55	2014.2	2044.2	24.71	24.85	24.41	2014.2	2044.2	0.69	0.40	0.28
2075.0	2105.0	10.16	8.90	8.55	2075.0	2105.0	23.65	24.19	23.68	2075.0	2105.0	0.72	0.43	0.29
2156.0	2186.0	10.12	8.94	8.58	2156.0	2186.0	23.19	23.44	23.25	2156.0	2186.0	0.78	0.46	0.30
2216.7	2246.7	10.11	9.02	8.64	2216.7	2246.7	23.23	23.07	22.97	2216.7	2246.7	0.86	0.49	0.33
2297.7	2327.7	10.12	9.12	8.76	2297.7	2327.7	23.21	23.44	23.26	2297.7	2327.7	0.99	0.55	0.38
2358.4	2388.4	10.05	9.18	8.84	2358.4	2388.4	22.49	23.35	23.34	2358.4	2388.4	1.13	0.58	0.36
2439.4	2469.4	9.98	9.27	8.96	2439.4	2469.4	22.56	23.92	24.40	2439.4	2469.4	1.14	0.60	0.39
2500.1	2530.1	10.10	9.43	9.15	2500.1	2530.1	21.79	23.51	24.51	2500.1	2530.1	1.32	0.64	0.38

REV. X2
SYM-10DH+
100818

Page 1 of 5



IF/RF MICROWAVE COMPONENTS • ISO 9001 ISO 14001 AS 9100 CERTIFIED • RoHS compliant
P.O. Box 350166, Brooklyn, New York 11235-0003 (718) 934-4500 Fax (718) 332-4661



The Design Engineers Search Engine finds the model you need, Instantly • For detailed performance specs & shopping online see



Frequency Mixer

SYM-10DH+

Typical Performance Data

IF (OUT) (MHz)	LO (MHz)	CONVERSION LOSS VS. IF FREQUENCY @RF(IN)=900.1MHz (dB)	IF (OUT) (MHz)	LO (MHz)	CONVERSION LOSS VS. IF FREQUENCY @RF(IN)=800.1MHz (dB)	IF (OUT) (MHz)	LO (MHz)	CONVERSION LOSS VS. IF FREQUENCY @RF(IN)=1000.1MHz (dB)
		@LO (dBm)			@LO (dBm)			@LO (dBm)
		+17			+17			+17
100.0	800.1	7.79	20.0	820.1	7.64	200.0	800.1	8.15
95.3	804.8	7.81	24.6	824.7	7.64	195.4	804.7	8.15
90.5	809.6	7.81	29.2	829.3	7.63	190.8	809.3	8.13
85.8	814.3	7.79	33.8	833.9	7.59	186.2	813.9	8.14
81.1	819.0	7.78	38.5	838.6	7.56	181.5	818.6	8.16
76.3	823.8	7.76	43.1	843.2	7.52	176.9	823.2	8.17
71.6	828.5	7.76	47.7	847.8	7.52	172.3	827.8	8.16
66.8	833.3	7.77	52.3	852.4	7.53	167.7	832.4	8.13
62.1	838.0	7.78	56.9	857.0	7.47	163.1	837.0	8.11
57.4	842.7	7.77	61.5	861.6	7.52	158.5	841.6	8.09
52.6	847.5	7.79	66.2	866.3	7.52	153.8	846.3	8.08
47.9	852.2	7.80	70.8	870.9	7.49	149.2	850.9	8.12
43.2	856.9	7.77	75.4	875.5	7.48	144.6	855.5	8.13
38.4	861.7	7.78	80.0	880.1	7.48	140.0	860.1	8.14
33.7	866.4	7.80	84.6	884.7	7.49	135.4	864.7	8.15
28.9	871.2	7.84	89.2	889.3	7.48	130.8	869.3	8.14
24.2	875.9	7.87	93.8	893.9	7.52	126.2	873.9	8.12
19.5	880.6	7.90	98.5	898.6	7.50	121.5	878.6	8.13
14.7	885.4	7.91	103.1	903.2	7.49	116.9	883.2	8.14
10.0	890.1	7.89	107.7	907.8	7.46	112.3	887.8	8.16
10.0	910.1	8.09	112.3	912.4	7.45	107.7	892.4	8.18
14.7	914.8	8.03	116.9	917.0	7.45	103.1	897.0	8.19
19.5	919.6	7.96	121.5	921.6	7.46	98.5	901.6	8.19
24.2	924.3	7.93	126.2	926.3	7.47	93.8	906.3	8.17
28.9	929.0	7.91	130.8	930.9	7.47	89.2	910.9	8.17
33.7	933.8	7.89	135.4	935.5	7.45	84.6	915.5	8.20
38.4	938.5	7.89	140.0	940.1	7.44	80.0	920.1	8.24
43.2	943.3	7.89	144.6	944.7	7.43	75.4	924.7	8.27
47.9	948.0	7.89	149.2	949.3	7.42	70.8	929.3	8.28
52.6	952.7	7.87	153.8	953.9	7.43	66.2	933.9	8.27
57.4	957.5	7.84	158.5	958.6	7.44	61.5	938.6	8.27
62.1	962.2	7.84	163.1	963.2	7.44	56.9	943.2	8.22
66.8	966.9	7.84	167.7	967.8	7.43	52.3	947.8	8.29
71.6	971.7	7.86	172.3	972.4	7.41	47.7	952.4	8.31
76.3	976.4	7.87	176.9	977.0	7.39	43.1	957.0	8.35
81.1	981.2	7.86	181.5	981.6	7.38	38.5	961.6	8.38
85.8	985.9	7.86	186.2	986.3	7.40	33.8	966.3	8.38
90.5	990.6	7.85	190.8	990.9	7.41	29.2	970.9	8.38
95.3	995.4	7.83	195.4	995.5	7.40	24.6	975.5	8.38
100.0	1000.1	7.82	200.0	1000.1	7.40	20.0	980.1	8.40

REV. X2
SYM-10DH+
100818
Page 2 of 5



IF/RF MICROWAVE COMPONENTS • ISO 9001 ISO 14001 AS 9100 CERTIFIED • RoHS compliant
P.O. Box 350166, Brooklyn, New York 11235-0003 (718) 934-4500 Fax (718) 332-4661



The Design Engineers Search Engine finds the model you need, Instantly • For detailed performance specs & shopping online see



Frequency Mixer

SYM-10DH+

Typical Performance Data

LO (MHz)	LO-RF ISOLATION (dB)			LO-IF ISOLATION (dB)		
	@LO (dBm)			@LO (dBm)		
	+14	+17	+20	+14	+17	+20
10.1	38.25	43.17	48.05	30.19	32.25	34.19
70.8	48.90	57.93	58.34	36.38	40.30	44.60
131.6	53.21	55.65	50.66	38.53	43.61	47.18
192.3	56.86	51.64	47.24	40.36	44.20	44.36
253.0	59.10	48.88	44.90	41.74	43.38	41.36
313.8	60.32	46.90	43.60	43.09	41.70	39.18
374.5	55.92	44.96	42.52	43.54	39.57	37.30
435.2	53.40	44.56	41.97	42.14	38.17	36.13
496.0	52.56	44.05	41.74	39.72	36.28	34.76
556.7	52.60	44.52	41.70	36.17	34.07	33.01
617.4	53.29	44.88	41.81	33.66	32.25	31.83
678.1	51.97	44.27	41.38	32.13	31.06	30.56
738.9	48.42	42.69	40.55	31.10	29.77	29.31
799.6	46.18	42.74	41.06	30.81	29.62	28.99
860.3	45.97	42.83	40.67	30.78	29.31	28.32
921.1	44.70	42.02	40.05	30.60	28.80	27.91
981.8	42.68	41.17	39.41	30.05	28.51	27.46
1042.5	41.15	40.54	38.48	29.50	27.87	26.72
1103.3	38.21	38.70	37.24	29.18	27.65	26.48
1164.0	36.52	37.16	36.33	28.71	27.47	26.41
1224.7	34.99	35.79	35.51	28.40	27.23	26.25
1285.5	33.73	34.67	34.89	28.18	27.16	26.19
1346.2	32.82	33.55	34.08	27.67	26.93	26.27
1406.9	31.77	32.79	33.34	27.25	26.99	26.30
1467.7	30.55	31.99	32.91	26.80	27.09	26.72
1528.4	29.67	31.20	32.35	26.39	26.94	26.93
1589.1	29.04	30.73	31.91	26.18	26.63	26.79
1649.9	28.01	29.95	31.64	25.80	26.13	26.37
1730.8	27.04	29.03	30.76	25.37	25.43	25.46
1791.6	25.75	27.80	29.85	24.81	24.57	24.68
1872.5	24.70	26.59	28.54	23.98	23.59	23.60
1933.3	24.25	26.10	27.93	23.58	22.95	22.72
2014.2	23.48	25.29	26.92	23.02	22.46	22.01
2075.0	23.13	25.00	26.50	22.54	22.11	21.60
2156.0	22.44	24.27	25.97	21.90	21.57	21.15
2216.7	22.20	23.80	25.32	21.66	21.41	20.73
2297.7	22.08	23.62	25.17	21.23	21.00	20.62
2358.4	21.85	23.38	24.70	21.16	20.94	20.36
2439.4	21.68	22.84	24.15	21.26	20.88	20.42
2500.1	21.72	22.88	24.03	21.17	20.87	20.38

RF (IN) (MHz)	LO (MHz)	RF-IF ISOLATION (dB)		
		@LO (dBm)		
		+14	+17	+20
10.1	40.1	25.10	25.56	24.83
70.8	100.8	27.80	27.92	27.82
131.6	161.6	28.54	28.69	28.64
192.3	222.3	29.31	29.26	29.03
253.0	283.0	29.87	29.90	29.80
313.8	343.8	30.49	30.57	30.40
374.5	404.5	31.47	31.16	30.92
435.2	465.2	33.01	32.25	32.03
496.0	526.0	35.04	34.44	34.01
556.7	586.7	35.59	35.06	34.47
617.4	647.4	34.63	34.64	34.72
678.1	708.1	35.16	35.63	35.95
738.9	768.9	36.58	36.55	36.21
799.6	829.6	38.02	36.17	34.92
860.3	890.3	35.64	33.98	33.15
921.1	951.1	33.43	32.49	32.00
981.8	1011.8	34.22	33.80	32.92
1042.5	1072.5	37.05	36.96	36.32
1103.3	1133.3	40.26	45.62	46.74
1164.0	1194.0	34.69	37.42	38.58
1224.7	1254.7	30.20	31.75	32.37
1285.5	1315.5	27.57	28.60	29.13
1346.2	1376.2	25.94	26.62	27.01
1406.9	1436.9	24.85	25.41	25.75
1467.7	1497.7	24.52	24.94	25.29
1528.4	1558.4	24.35	24.60	24.97
1589.1	1619.1	24.26	24.16	24.52
1649.9	1679.9	24.43	24.10	24.14
1730.8	1760.8	24.54	24.27	24.04
1791.6	1821.6	24.69	24.33	24.19
1872.5	1902.5	24.73	24.25	24.02
1933.3	1963.3	24.83	24.37	24.18
2014.2	2044.2	24.90	24.39	24.34
2075.0	2105.0	25.16	24.53	24.42
2156.0	2186.0	25.44	25.08	24.84
2216.7	2246.7	25.68	25.63	25.64
2297.7	2327.7	25.87	25.90	26.01
2358.4	2388.4	26.29	26.23	26.40
2439.4	2469.4	27.15	26.70	26.46
2500.1	2530.1	27.48	27.11	26.73

Frequency Mixer

SYM-10DH+

Typical Performance Data

RF (IN) (MHz)	LO (MHz)	RF VSWR (:1)		
		@LO (dBm)		
		+14	+17	+20
10.1	40.1	1.55	1.40	1.31
70.8	100.8	1.62	1.46	1.36
131.6	161.6	1.61	1.45	1.35
192.3	222.3	1.61	1.45	1.35
253.0	283.0	1.56	1.41	1.30
313.8	343.8	1.53	1.37	1.27
374.5	404.5	1.51	1.34	1.26
435.2	465.2	1.45	1.30	1.23
496.0	526.0	1.41	1.27	1.21
556.7	586.7	1.37	1.25	1.19
617.4	647.4	1.33	1.24	1.19
678.1	708.1	1.31	1.24	1.20
738.9	768.9	1.33	1.26	1.22
799.6	829.6	1.38	1.30	1.24
860.3	890.3	1.42	1.34	1.28
921.1	951.1	1.49	1.40	1.34
981.8	1011.8	1.57	1.47	1.42
1042.5	1072.5	1.65	1.58	1.53
1103.3	1133.3	1.77	1.70	1.65
1164.0	1194.0	1.89	1.81	1.75
1224.7	1254.7	1.99	1.90	1.83
1285.5	1315.5	2.07	1.97	1.89
1346.2	1376.2	2.15	2.03	1.95
1406.9	1436.9	2.21	2.08	1.99
1467.7	1497.7	2.24	2.12	2.02
1528.4	1558.4	2.30	2.16	2.04
1589.1	1619.1	2.33	2.18	2.06
1649.9	1679.9	2.34	2.19	2.08
1730.8	1760.8	2.34	2.18	2.07
1791.6	1821.6	2.32	2.16	2.06
1872.5	1902.5	2.28	2.13	2.03
1933.3	1963.3	2.25	2.09	1.99
2014.2	2044.2	2.20	2.03	1.92
2075.0	2105.0	2.15	1.99	1.87
2156.0	2186.0	2.05	1.92	1.80
2216.7	2246.7	1.97	1.87	1.76
2297.7	2327.7	1.88	1.78	1.69
2358.4	2388.4	1.79	1.69	1.62
2439.4	2469.4	1.66	1.58	1.53
2500.1	2530.1	1.61	1.54	1.49

LO (MHz)	LO VSWR (:1)		
	@LO (dBm)		
	+14	+17	+20
10.1	1.16	1.54	2.20
70.8	1.05	1.51	2.22
131.6	1.10	1.53	2.29
192.3	1.12	1.51	2.17
253.0	1.15	1.46	2.13
313.8	1.19	1.43	2.08
374.5	1.20	1.47	2.11
435.2	1.22	1.39	1.95
496.0	1.28	1.31	1.88
556.7	1.33	1.32	1.86
617.4	1.35	1.25	1.77
678.1	1.47	1.23	1.68
738.9	1.54	1.23	1.68
799.6	1.53	1.22	1.58
860.3	1.59	1.21	1.52
921.1	1.70	1.20	1.52
981.8	1.65	1.17	1.44
1042.5	1.66	1.15	1.39
1103.3	1.79	1.13	1.39
1164.0	1.67	1.10	1.33
1224.7	1.66	1.08	1.33
1285.5	1.74	1.06	1.38
1346.2	1.61	1.07	1.36
1406.9	1.58	1.08	1.38
1467.7	1.63	1.12	1.44
1528.4	1.57	1.15	1.47
1589.1	1.46	1.20	1.53
1649.9	1.47	1.24	1.61
1730.8	1.42	1.32	1.66
1791.6	1.46	1.34	1.71
1872.5	1.39	1.38	1.74
1933.3	1.36	1.40	1.75
2014.2	1.31	1.43	1.78
2075.0	1.28	1.47	1.82
2156.0	1.28	1.50	1.85
2216.7	1.28	1.53	1.84
2297.7	1.31	1.59	1.90
2358.4	1.34	1.62	1.91
2439.4	1.37	1.64	1.93
2500.1	1.42	1.68	1.96

IF (OUT) (MHz)	IF VSWR @LO=1000.1MHz (:1)		
	@LO (dBm)		
	+14	+17	+20
20.0	1.26	1.11	1.16
24.6	1.18	1.08	1.18
29.2	1.16	1.12	1.23
33.8	1.16	1.06	1.18
38.5	1.20	1.13	1.23
43.1	1.15	1.13	1.25
47.7	1.13	1.13	1.26
52.3	1.13	1.11	1.23
56.9	1.14	1.11	1.23
61.5	1.10	1.10	1.23
66.2	1.11	1.10	1.22
70.8	1.13	1.09	1.21
75.4	1.11	1.09	1.22
80.0	1.10	1.10	1.23
84.6	1.13	1.06	1.19
89.2	1.12	1.07	1.21
93.8	1.13	1.08	1.21
98.5	1.14	1.07	1.20
103.1	1.15	1.06	1.19
107.7	1.15	1.08	1.20
112.3	1.16	1.07	1.19
116.9	1.17	1.07	1.18
121.5	1.17	1.08	1.19
126.2	1.19	1.08	1.18
130.8	1.18	1.07	1.18
135.4	1.18	1.06	1.17
140.0	1.17	1.07	1.18
144.6	1.17	1.07	1.17
149.2	1.16	1.07	1.18
153.8	1.15	1.07	1.19
158.5	1.13	1.08	1.20
163.1	1.14	1.08	1.20
167.7	1.13	1.09	1.21
172.3	1.14	1.09	1.21
176.9	1.13	1.09	1.21
181.5	1.15	1.07	1.20
186.2	1.16	1.07	1.19
190.8	1.17	1.07	1.19
195.4	1.17	1.06	1.17
200.0	1.19	1.06	1.17

Harmonics Tables

RF HARMONICS ORDER

	(-dBm)	(-dBc)										
0	-	-	4	19	27	20	34	23	22	40	40	32
1	-	24	+0	34	18	51	19	42	40	41	38	59
2	89	57	45	57	46	55	54	59	52	58	53	67
3	>100	73	65	74	57	72	60	77	57	79	61	75
4	>100	84	80	85	>91	87	89	85	77	90	89	88
5	>100	>91	>91	>91	>91	>91	>91	>91	>91	>91	>91	>91
6	>100	>91	>91	>91	>91	>91	>91	>91	>91	>91	>91	>91
7	>100	>91	>91	>91	>91	>91	>91	>91	>91	>91	>91	>91
8	>100	>91	>91	>91	>91	>91	>91	>91	>91	>91	>91	>91
9	>100	>91	>91	>91	>91	>91	>91	>91	>91	>91	>91	>91
10	>100	>91	>91	>91	>91	>91	>91	>91	>91	>91	>91	>91
	RF CAL	0	1	2	3	4	5	6	7	8	9	10

LO HARMONICS ORDER

Test conditions: RF IN: 900.1 MHz; -1.00 dBm.
 LO IN: 930.01 MHz; +17.00 dBm
 IF OUT: 29.91 MHz; -8.89 dBm

RF HARMONICS ORDER

	(-dBm)	(-dBc)										
0	-	-	14	28	42	29	45	35	40	51	59	48
1	-	24	+0	34	17	59	21	46	42	45	45	53
2	73	46	37	45	41	46	45	50	45	52	46	63
3	>100	52	46	53	42	50	44	65	45	65	47	62
4	>100	64	58	62	61	78	52	67	78	63	58	67
5	>100	77	59	66	57	74	53	68	58	73	54	73
6	>100	82	73	79	70	80	77	72	66	68	63	68
7	>100	86	83	86	83	88	79	90	75	78	78	86
8	>100	93	92	>101	89	94	90	89	82	85	76	86
9	>100	>101	99	>101	100	>101	89	89	88	89	78	>101
10	>100	>101	99	101	96	>101	93	>101	>101	98	88	84
	RF CAL	0	1	2	3	4	5	6	7	8	9	10

LO HARMONICS ORDER

Test conditions: RF IN: 900.1 MHz; 9.00 dBm.
 LO IN: 930.01 MHz; +17.00 dBm
 IF OUT: 29.91 MHz; 1.14 dBm

- Notes: 1. All Harmonics are in (dBc) relative to IF OUTPUT.
 2. + entry denotes harmonics are in (dBc) above IF OUTPUT.
 3. RF Cal represent the Harmonics level of the RF input signal to the mixer.

REV. X2
 SYM-10DH+
 100818
 Page 5 of 5



IF/RF MICROWAVE COMPONENTS • ISO 9001 ISO 14001 AS 9100 CERTIFIED • RoHS compliant
 P.O. Box 350166, Brooklyn, New York 11235-0003 (718) 934-4500 Fax (718) 332-4661



The Design Engineers Search Engine finds the model you need, Instantly • For detailed performance specs & shopping online see minicircuits.com

Typical Performance Curves

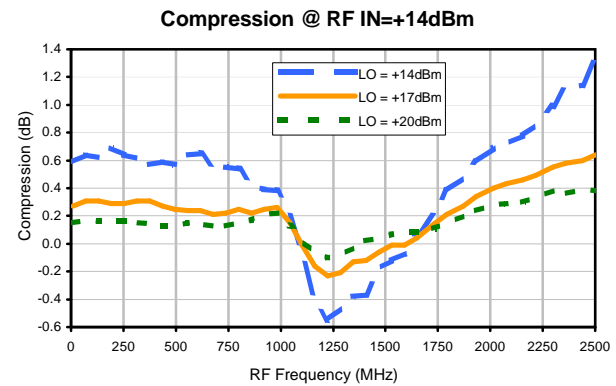
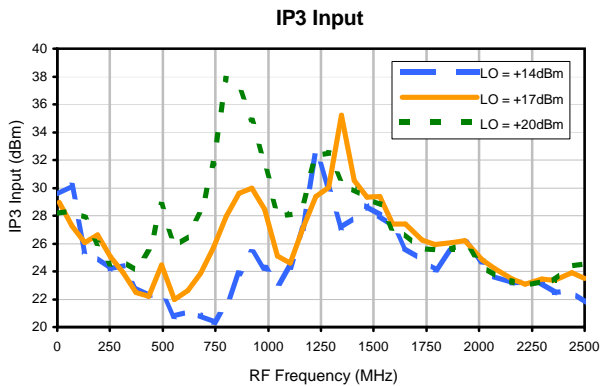
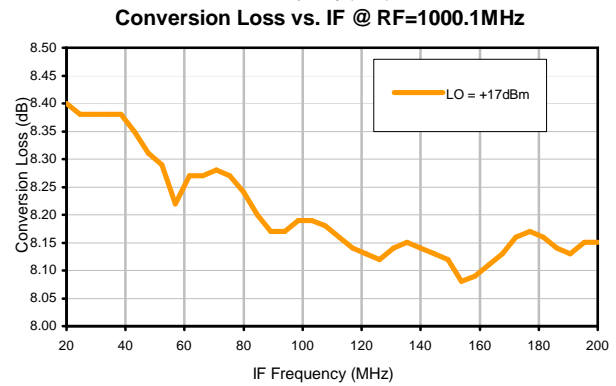
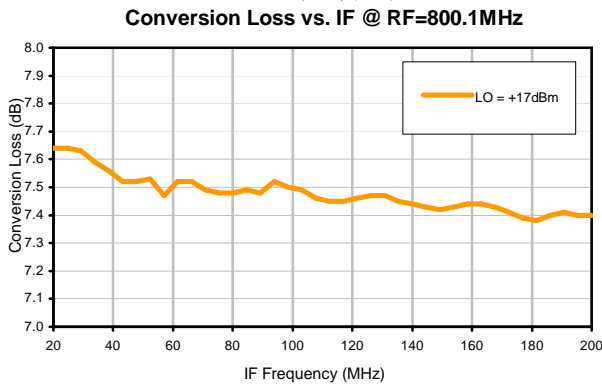
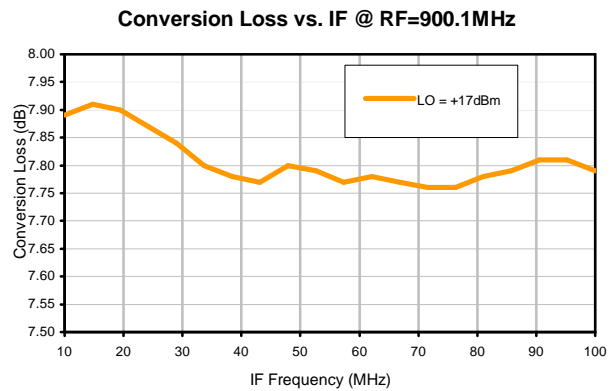
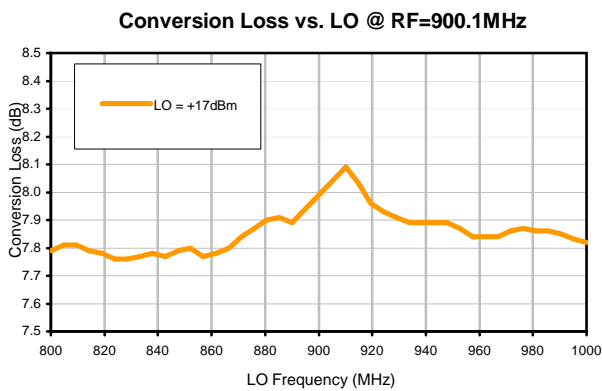
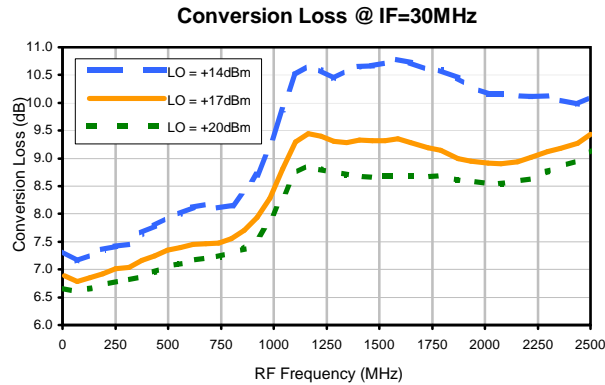

Frequency Mixer

SYM-10DH+

Typical Performance Curves

LO-RF Isolation

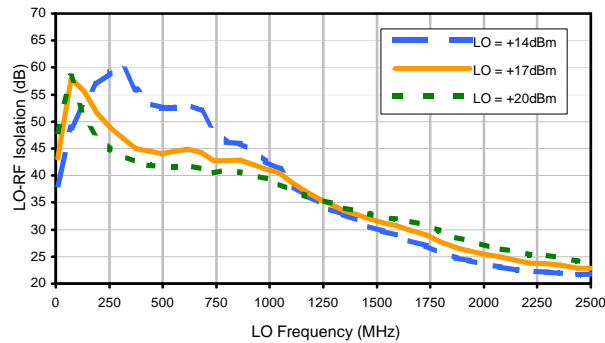

LO-IF Isolation

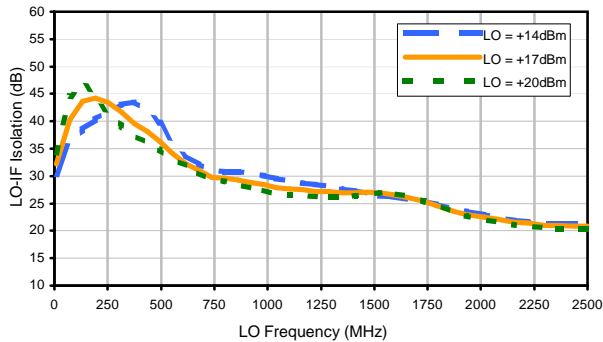

RF-IF Isolation

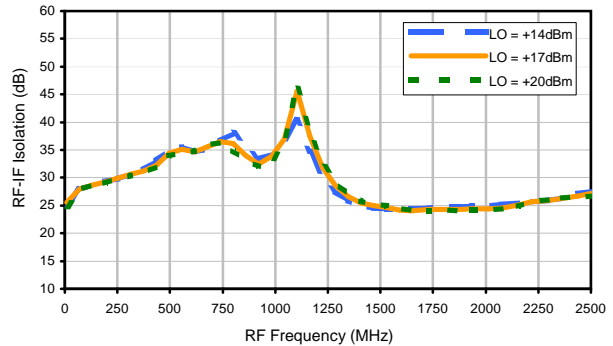

RF VSWR

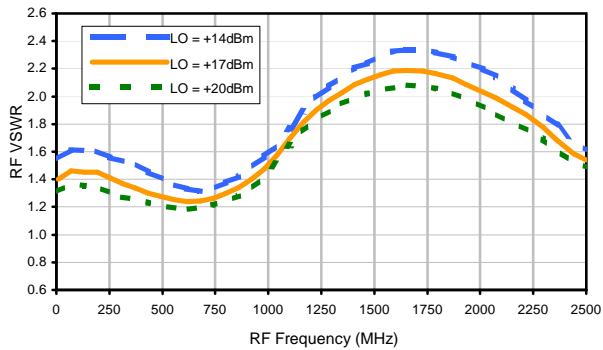

LO VSWR

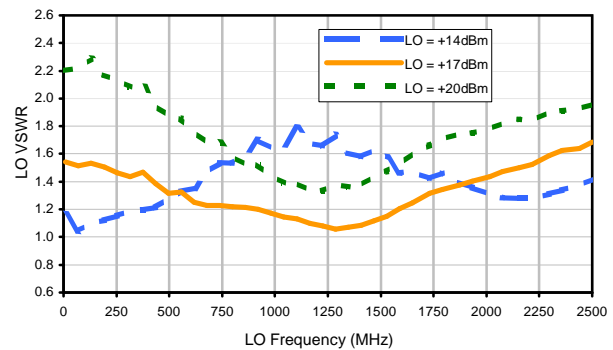

IF VSWR

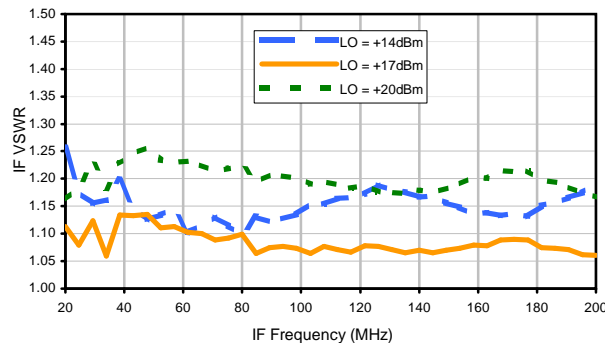

REV. X2
SYM-10DH+
100818
Page 2 of 3



IF/RF MICROWAVE COMPONENTS • ISO 9001 ISO 14001 AS 9100 CERTIFIED RoHS compliant
P.O. Box 350166, Brooklyn, New York 11235-0003 (718) 934-4500 Fax (718) 332-4661



The Design Engineers Search Engine finds the model you need, Instantly • For detailed performance specs & shopping online see



Harmonics Tables

RF HARMONICS ORDER

	(-dBm)	(-dBc)										
0	-	-	4	19	27	20	34	23	22	40	40	32
1	-	24	+0	34	18	51	19	42	40	41	38	59
2	89	57	45	57	46	55	54	59	52	58	53	67
3	>100	73	65	74	57	72	60	77	57	79	61	75
4	>100	84	80	85	>91	87	89	85	77	90	89	88
5	>100	>91	>91	>91	>91	>91	>91	>91	>91	>91	>91	>91
6	>100	>91	>91	>91	>91	>91	>91	>91	>91	>91	>91	>91
7	>100	>91	>91	>91	>91	>91	>91	>91	>91	>91	>91	>91
8	>100	>91	>91	>91	>91	>91	>91	>91	>91	>91	>91	>91
9	>100	>91	>91	>91	>91	>91	>91	>91	>91	>91	>91	>91
10	>100	>91	>91	>91	>91	>91	>91	>91	>91	>91	>91	>91
	RF CAL	0	1	2	3	4	5	6	7	8	9	10

LO HARMONICS ORDER

Test conditions: RF IN: 900.1 MHz; -1.00 dBm.
 LO IN: 930.01 MHz; +17.00 dBm
 IF OUT: 29.91 MHz; -8.89 dBm

RF HARMONICS ORDER

	(-dBm)	(-dBc)										
0	-	-	14	28	42	29	45	35	40	51	59	48
1	-	24	+0	34	17	59	21	46	42	45	45	53
2	73	46	37	45	41	46	45	50	45	52	46	63
3	>100	52	46	53	42	50	44	65	45	65	47	62
4	>100	64	58	62	61	78	52	67	78	63	58	67
5	>100	77	59	66	57	74	53	68	58	73	54	73
6	>100	82	73	79	70	80	77	72	66	68	63	68
7	>100	86	83	86	83	88	79	90	75	78	78	86
8	>100	93	92	>101	89	94	90	89	82	85	76	86
9	>100	>101	99	>101	100	>101	89	89	88	89	78	>101
10	>100	>101	99	101	96	>101	93	>101	>101	98	88	84
	RF CAL	0	1	2	3	4	5	6	7	8	9	10

LO HARMONICS ORDER

Test conditions: RF IN: 900.1 MHz; 9.00 dBm.
 LO IN: 930.01 MHz; +17.00 dBm
 IF OUT: 29.91 MHz; 1.14 dBm

- Notes: 1. All Harmonics are in (dBc) relative to IF OUTPUT.
 2. + entry denotes harmonics are in (dBc) above IF OUTPUT.
 3. RF Cal represent the Harmonics level of the RF input signal to the mixer.

REV. X2
 SYM-10DH+
 100818
 Page 3 of 3



IF/RF MICROWAVE COMPONENTS • ISO 9001 ISO 14001 AS 9100 CERTIFIED • RoHS compliant
 P.O. Box 350166, Brooklyn, New York 11235-0003 (718) 934-4500 Fax (718) 332-4661



The Design Engineers Search Engine finds the model you need, Instantly • For detailed performance specs & shopping online see minicircuits.com

Outline Dimensions

TTT166
TTT167

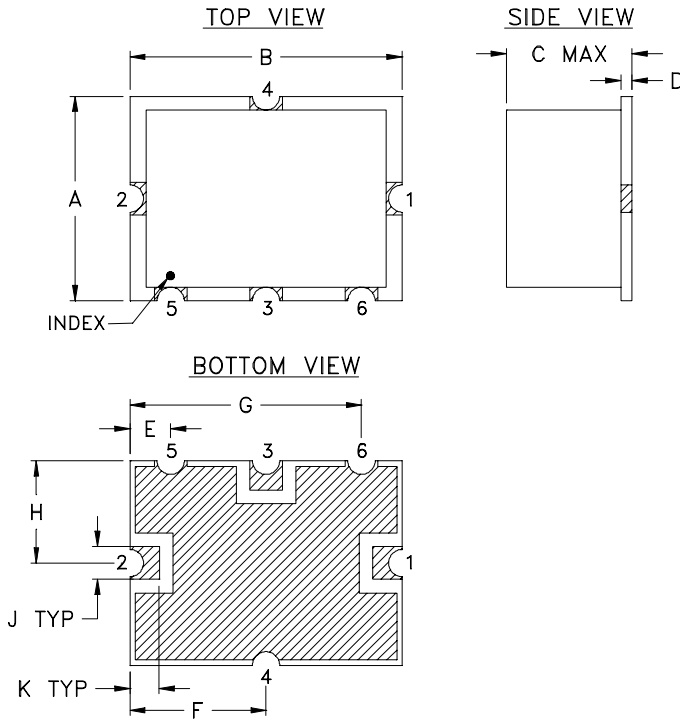

PCB Land Pattern

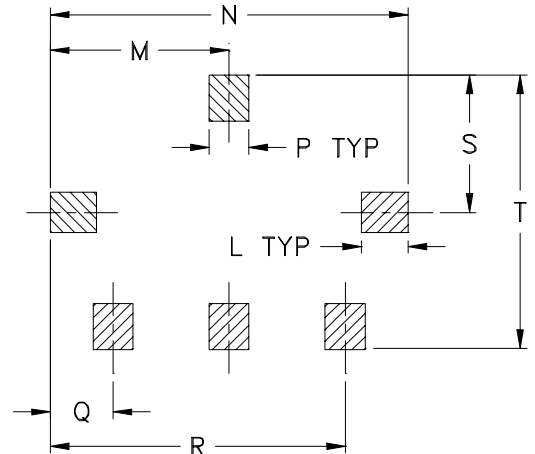

Suggested Layout,
Tolerance to be within $\pm .002$

CASE #	A	B	C	D	E	F	G	H	J	K	L	M	N
TTT166			.15 (3.81)										
TTT167	.38 (9.65)	.50 (12.70)	.23 (5.84)	.020 (0.51)	.075 (1.91)	.250 (6.35)	.425 (10.80)	.187 (4.75)	.050 (1.27)	.050 (1.27)	.070 (1.78)	.270 (6.86)	.540 (13.72)

CASE #	P	Q	R	S	T	WT. GRAM
TTT166	.060 (1.52)	.095 (2.41)	.445 (11.30)	.208 (5.28)	.415 (10.54)	.8
TTT167						.8

Dimensions are in inches (mm). Tolerances: 2 Pl. $\pm .01$; 3 Pl. $\pm .005$

Note:

- Case material: Plastic.
- Base material: Printed wiring laminate.
- Termination finish:
 - For RoHS Case Styles: 3-5 μ inch (.08-.13 microns) Gold over 120-240 μ inch (3.05-6.10 microns) Nickel plate. All models, (+) suffix.
 - For RoHS-5 Case Styles: Tin-Lead plate. All models, no (+) suffix.

Tape & Reel Packaging TR-F12

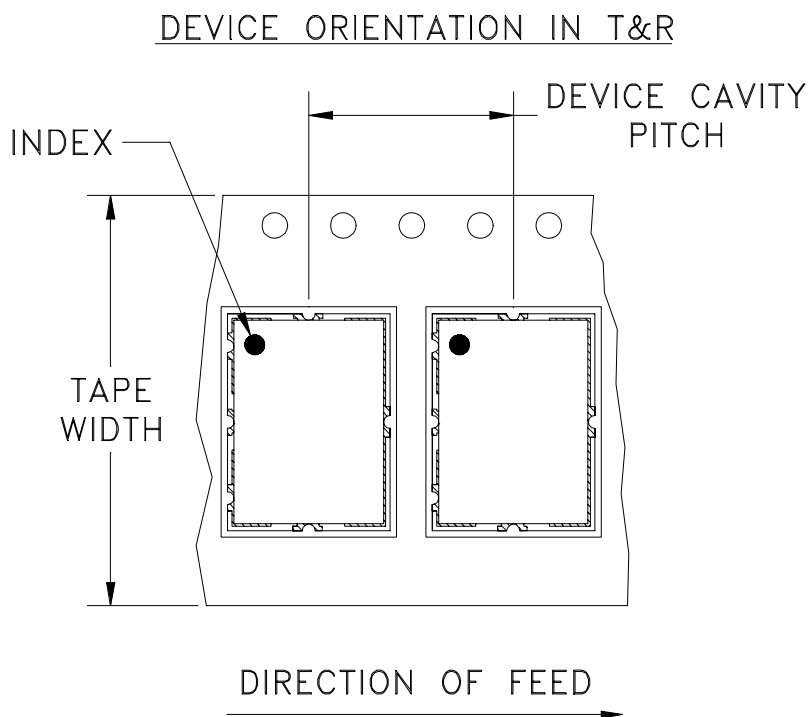

Tape Width, mm	Device Cavity Pitch, mm	Reel Size, inches	Devices per Reel	
24	12	7	Small quantity standards (see note)	10
				20
				50
				100
				200
		13	Standard	500

Note: Please Consult individual model data sheet to determine device per reel availability.

Mini-Circuits carrier tape materials provide protection from ESD (Electro-Static Discharge) during handling and transportation. Tapes are static dissipative and comply with industry standards EIA-481/EIA-541.

Go to: www.minicircuits.com/pages/pdfs/tape.pdf



Distribution Centers NORTH AMERICA 800-654-7949 • 417-335-5935 • Fax 417-335-5945 • EUROPE 44-1252-832600 • Fax 44-1252-837010

Mini-Circuits ISO 9001 & ISO 14001 Certified

INTERNET <http://www.minicircuits.com>

P.O. Box 350166, Brooklyn, New York 11235-0003 (718) 934-4500 Fax (718) 332-4661

THIRD ANGLE PROJECTION

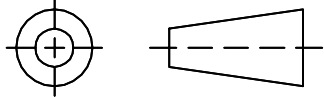

REVISIONS

REV	ECN No.	DESCRIPTION	DATE	DR	AUTH
A	M86762	ADDED CONNECTIONS "lp & lq"	05/23/03	MMG	WL
B	M94598	ADDED CONNECTION "hk"	10/08/04	MMG	HY
C	M102713	UPDATED NOTES & DESCRIPTION	01/14/06	GF	IL
D	M132989	UPDATED NOTE 2	08/24/11	GF	DJ

SUGGESTED MOUNTING CONFIGURATION FOR
TTT166/167 CASE STYLE, "hk"/"lp"/"lq"
"x"/"ck"/"ec" PIN CONNECTIONS

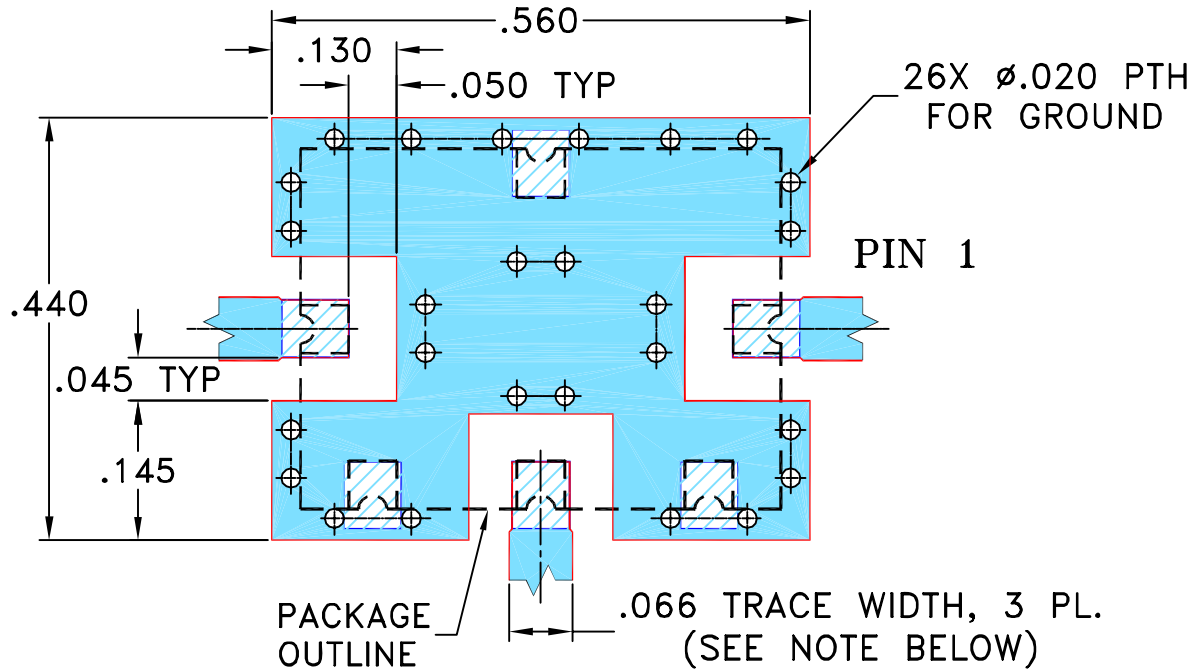

NOTE:

1. TRACE WIDTH IS SHOWN FOR ROGERS R04350B WITH DIELECTRIC THICKNESS .030" ± .002"; COPPER: 1/2 OZ. EACH SIDE. FOR OTHER MATERIALS TRACE WIDTH MAY NEED TO BE MODIFIED.
2. THE USE OF SOLDER MASK OVER THE GROUND AREA UNDER THE UNIT AS SHOWN IS RECOMMENDED TO PREVENT POTENTIAL SHORTING. IF USER CHOOSES TO EXPOSE METAL UNDER THE ENTIRE UNIT GROUND PAD FOR IMPROVED GROUNDING, IT IS RECOMMENDED A SOLDER MASK DAM BE APPLIED AROUND EACH GROUND PAD TO ENSURE FILLET AND CONNECTION AT GROUND PADS.
3. BOTTOM SIDE OF THE PCB IS CONTINUOUS GROUND PLANE.



DENOTES PCB COPPER LAYOUT WITH SMOBC (SOLDER MASK OVER BARE COPPER), SEE NOTE 2.

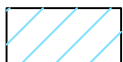

DENOTES COPPER LAND PATTERN FREE OF SOLDER MASK

UNLESS OTHERWISE SPECIFIED

DIMENSIONS ARE IN INCHES
TOLERANCES ON:
2 PL DECIMALS ±
3 PL DECIMALS ± .005
ANGLES ±
FRACTIONS ±

	INITIALS	DATE
DRAWN	GF	03/18/03
CHECKED	IL	04/15/03
APPROVED	DJ	04/15/03



Mini-Circuits® 13 Neptune Avenue
Brooklyn NY 11235

PL, hk/lp/lq/x/ck/ec, TTT166/167,
SYM/HJK/SYAS/SYPD, TB-12

Mini-Circuits®
THIS DOCUMENT AND ITS CONTENTS ARE THE PROPERTY OF MINI-CIRCUITS. EXCEPT FOR USE EXPRESSLY GRANTED, IN WRITING, TO ITS VENDORS, VENDEE AND THE UNITED STATES GOVERNMENT, MINI-CIRCUITS RESERVES ALL PROPRIETARY DESIGN, USE, MANUFACTURING AND REPRODUCTION RIGHTS THERETO. THESE CONTENTS SHALL NOT BE USED, DUPLICATED OR DISCLOSED TO ANY OUTSIDE PARTY, IN WHOLE OR IN PART, WITHOUT WRITTEN PERMISSION OF MINI-CIRCUITS.

SIZE	CODE IDENT	DRAWING NO:	REV:
A	15542	98-PL-079	D
FILE:	98PL079	SCALE: 5:1	SHEET: 1 OF 1

Evaluation Board and Circuit

For Pin Connections Refer to Data Sheet of the DUT

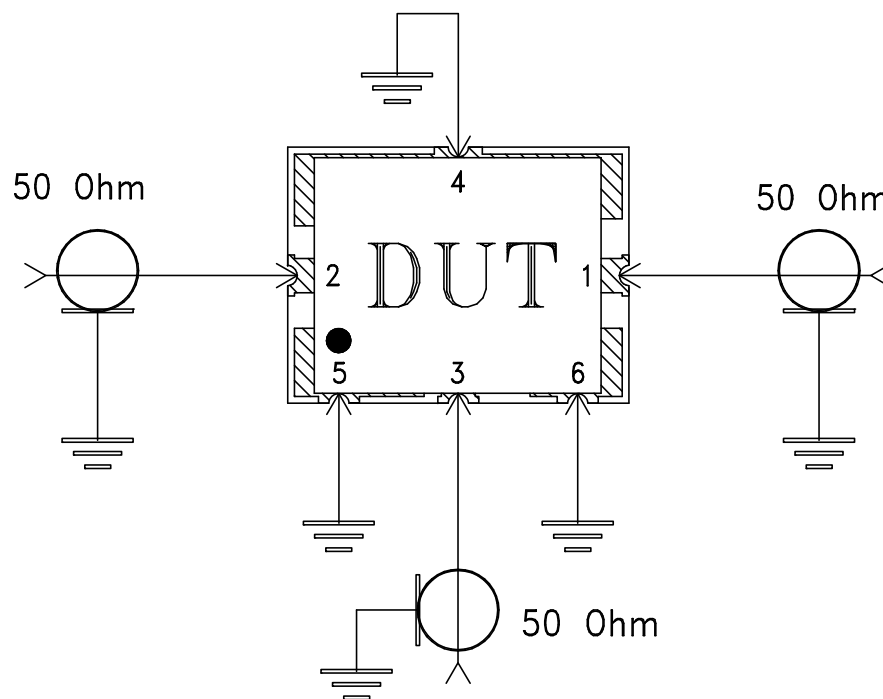
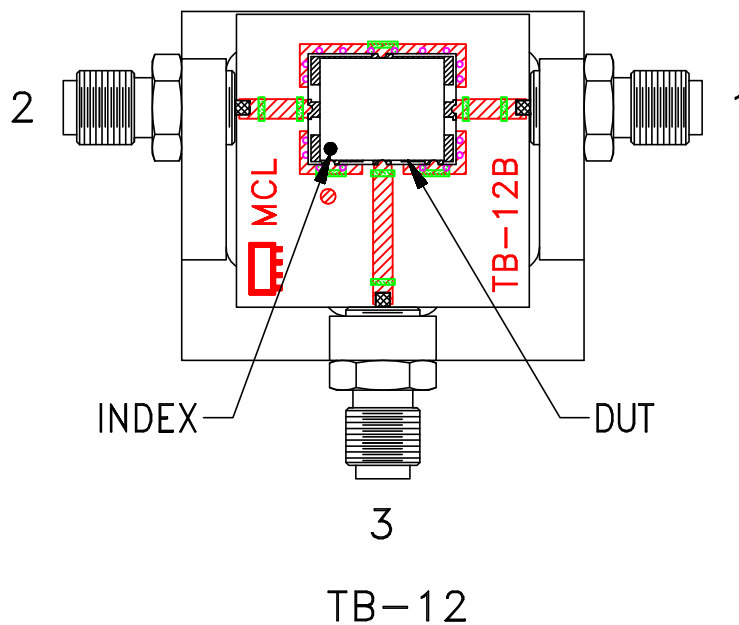

Schematic Diagram

Notes:

1. SMA Female connectors.
2. PCB Material: Rogers R04350 or equivalent, Dielectric Constant=3.5, Thickness=.030 inch.

 **Mini-Circuits®**



All Mini-Circuits products are manufactured under exacting quality assurance and control standards, and are capable of meeting published specifications after being subjected to any or all of the following physical and environmental test.

Specification	Test/Inspection Condition	Reference/Spec
Operating Temperature	-40° to 85°C Ambient Environment	Individual Model Data Sheet
Storage Temperature	-55° to 100° C Ambient Environment	Individual Model Data Sheet
Humidity	90 to 95% RH, 240 hours, 50°C	MIL-STD-202, Method 103, Condition A, Except 50°C and end-point electrical test done within 12 hours
Thermal Shock	-55° to 100°C, 100 cycles	MIL-STD-202, Method 107, Condition A-3, except +100°C
Solder Reflow Heat	Sn-Pb Eutetic Process: 225°C peak Pb-Free Process 245° - 250°C peak	J-STD-020, Table 4-1, 4-2 and 5-2, Figure 5-1
Solderability	10X Magnification	J-STD-002, 95% Coverage
Vibration (High Frequency)	20g peak, 10-2000 Hz, 12 times in each of three perpendicular directions (total 36)	MIL-STD-202, Method 204, Condition D
Mechanical Shock	50g, 11 ms, 1/2-sine, 18 shocks: 3 each direction, each of 3 axes	MIL-STD-202, Method 213, Condition A
Marking Resistance to Solvents	Isopropyl alcohol + mineral spirits at 25°C; terpene defluxer at 25°C; distilled water + proylene glycol monomethyl ether + monoethanolamine at 63°C to 70°C	MIL-STD-202, Method 215