

Low Noise, Wideband, High IP3

Monolithic Amplifier

CMA-83LN+

50Ω 0.5 to 8.0 GHz

The Big Deal

- Ceramic, hermetically sealed, nitrogen filled
- Low profile case, 0.045"
- Flat gain over wideband
- Low noise figure, 1.3 dB
- High IP3, up to +30 dBm



CASE STYLE: DL1721

*MIL Screening Available
Please consult Applications Dept.*

Product Overview

The CMA-83LN+ is a PHEMT based wideband, low noise MMIC amplifier with a unique combination of low noise, high IP3, and flat gain over wideband making it ideal for sensitive, high-dynamic-range receiver applications. This design operates on a single 5V or 6V supply, is well matched for 50Ω and comes in a tiny, low profile package (0.12 x 0.12 x 0.045"), accommodating dense circuit board layouts. The amplifier is bonded to a multilayer integrated LTCC substrate, then hermetically sealed under a controlled Nitrogen atmosphere with gold-plated cover, eutectic Au-Sn solder, and Ni-Pd-Au termination finish. CMA-series amplifiers are capable of meeting MIL requirements for gross leak, fine leak, thermal shock, vibration, acceleration, mechanical shock, and HTOL. The testing can be done if requested.

Key Features

Feature	Advantages
Hermetically Sealed	Ideal for use anywhere long-term reliability adds bottom-line value: high moisture areas, busy production lines, high-speed distribution centers, heavy industry, outdoor settings, and unmanned facilities, as well as military applications.
Low noise, 1.3 dB at 2 GHz	Enables lower system noise figure performance.
High IP3 <ul style="list-style-type: none">• +30 dBm at 2 GHz• +26.7 dBm at 8 GHz	Combination of low noise and high IP3 makes this MMIC amplifier ideal for use in low noise receiver front end (RFE) as it gives the user advantages of sensitivity and two-tone IM performance at both ends of the dynamic range.
Low operating voltage, 5V/6V.	Achieves high IP3 using low voltage.
Wide bandwidth with flat gain <ul style="list-style-type: none">• ±1.2 dB over 0.5 to 7 GHz• ±1.5 dB over 0.5 to 8 GHz	Enables a single amplifier to be used in many wideband applications including defense, instrumentation and more.
Ceramic, hermetic package	Low inductance, repeatable performance, outstanding reliability in tough operating conditions, and small size (0.12 x 0.12 x 0.045")



Low Noise, Wideband, High IP3

Monolithic Amplifier

0.5-8.0 GHz

Product Features

- Ceramic, hermetically sealed, high reliability
- Low profile case, .045" high
- Low Noise figure, 1.3 dB at 2 GHz
- High IP3, 30 dBm typ. at 2 GHz
- High Pout, P1dB 20.3 dBm typ. at 2 GHz and 6V
- Excellent Gain flatness, ± 1.2 dB over 0.5 to 7 GHz and 6V



Generic photo used for illustration purposes only

CASE STYLE: DL1721

CMA-83LN+

+RoHS Compliant

The +Suffix identifies RoHS Compliance. See our web site for RoHS Compliance methodologies and qualifications

Typical Applications

- High Rel Systems
- Defense and Aerospace
- WiFi
- WLAN
- UMTS
- LTE
- WiMAX
- S-band Radar
- C-band Satcom

General Description

The CMA-83LN+ is a PHEMT based wideband, low noise MMIC amplifier with a unique combination of low noise, high IP3, and flat gain over wideband making it ideal for sensitive, high-dynamic-range receiver applications. This design operates on a single 5V or 6V supply, is well matched for 50 Ω and comes in a tiny, low profile package (0.12 x 0.12 x 0.045"), accommodating dense circuit board layouts. The MMIC amplifier is bonded to a multilayer integrated LTCC substrate and then hermetically sealed under a controlled Nitrogen atmosphere with gold plated cover and eutectic Au-Sn solder. Terminal finish is Ni-Pd-Au. It has repeatable lot to lot performance due to tightly controlled semiconductor and assembly processes. These amplifiers are capable of meeting MIL requirements and have been tested for hermeticity.

simplified schematic and pad description

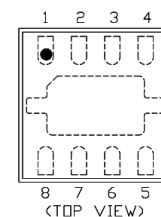
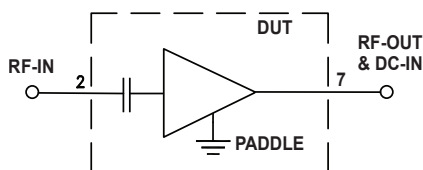

Function	Pad Number	Description
RF IN	2	Connects to RF input and to ground via L1 (optional blocking capacitor of 100pF may be used)
RF-OUT and DC-IN	7	Connects to RF out via C3 and VDD via L2
GND	1, 3, 5, 6, 8, Paddle	Connects to ground
NC	4	Not used internally. Connected to ground on test board.

* Enhancement mode pseudomorphic High Electron Mobility Transistor.



www.minicircuits.com P.O. Box 350166, Brooklyn, NY 11235-0003 (718) 934-4500 sales@minicircuits.com

REV. C
ECO-009471
CMA-83LN+
BT/CP/AM
210827
Page 2 of 5

Electrical Specifications⁽¹⁾ at 25°C and 5V/6V, unless noted

Parameter	Condition (GHz)	V _{DD} =6.0			V _{DD} =5.0			Units
		Min.	Typ.	Max.	Min.	Typ.	Max.	
Frequency Range		0.5		8.0	0.5		8.0	
Noise Figure	0.5	—	1.6	—	—	1.6	—	dB
	2.0	—	1.3	1.8	—	1.3	—	
	4.0	—	1.5	—	—	1.5	—	
	5.0	—	1.6	—	—	1.6	2.2	
	8.0	—	1.8	—	—	1.8	—	
Gain	0.5	—	21.2	—	—	20.2	—	dB
	2.0	18.5	21.5	24.4	—	20.8	—	
	4.0	—	20.6	—	—	19.7	—	
	5.0	—	20.1	—	14.9	19.3	—	
	8.0	—	19.2	—	—	18.7	—	
Input Return Loss	0.5		12.3			11.2		dB
	2.0		17.2			16.3		
	4.0		10.0			9.2		
	5.0		8.3			7.7		
	8.0		6.5			6.0		
Output Return Loss	0.5		14.4			15.0		dB
	2.0		17.5			21.4		
	4.0		20.1			17.4		
	5.0		13.6			12.4		
	8.0		6.4			6.3		
Output Power @ 1dB compression	0.5		17.6			16.0		dBm
	2.0		20.3			19.5		
	4.0		18.0			16.0		
	5.0		18.8		13.0	16.6	—	
	8.0		16.9			16.4		
Output IP3	0.5		29.4			26.1		dBm
	2.0		30.1			26.6		
	4.0		28.1			24.8		
	5.0		27.2		12.3	24.0	—	
	8.0		26.7			24.5		
Device Operating Voltage			6.0			5.0		V
Device Operating Current			62	94		50		mA
DC Current Variation Vs. Temp. ⁽²⁾			-157			-109		μA/°C
DC Current Variation Vs. Voltage at 25°C			0.016			0.016		mA/mV
Thermal Resistance			70			70		°C/W

1. Measured on Mini-Circuits Characterization test board TB-994+. See Characterization Test Circuit (Fig. 1)

2. (Current at 125°C - Current at -45°C)/170

Absolute Maximum Ratings⁽³⁾

Parameter	Ratings
Operating Temperature (ground lead)	-40°C to 125°C
Storage Temperature	-65°C to 150°C
Junction Temperature	150°C
Total Power Dissipation	0.95 W
Input Power (CW), V _d =5,6V ⁽⁴⁾	+19 dBm (5 minutes max.) +16 dBm (continuous)
DC Voltage	7 V

Note:

3. Permanent damage may occur if any of these limits are exceeded.

Electrical maximum ratings are not intended for continuous normal operation.

4. Measured on Mini-Circuits test board, TB-994+

Recommended Application and Characterization Test Circuit

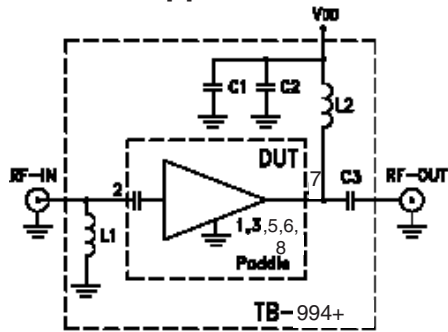

Component	Vendor	Vendor P/N	Value	Size
C1	Murata	GRM155R71E103KA01D	0.01 μ F	0402
C2	Murata	GJM1555C1H100JB01D	10pF	0402
C3	Murata	GRM1555C1H101JA01D	100pF	0402
L1	Murata	LQG15HS18NJ02D	18nH	0402
L2	Coilcraft	0402CS-39NXGLW	39nH	0402

Fig 1. Application and Characterization Circuit

Note: This block diagram is used for characterization. (DUT soldered on Mini-Circuits Characterization test board TB-994+) Gain, Return loss, Output power at 1dB compression (P1 dB), output IP3 (OIP3) and noise figure measured using Agilent's N5242A PNA-X microwave network analyzer.

Conditions:

1. Gain and Return loss: Pin= -25dBm
2. Output IP3 (OIP3): Two tones, spaced 1 MHz apart, 0 dBm/tone at output.

Suggested PCB Layout (PL-606)

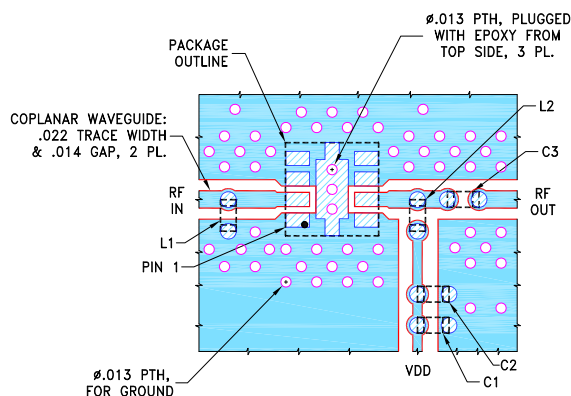

COMPONENT	SIZE
C1-C3, L1-L2	0402

NOTES:

1. TRACE WIDTH & GAP PARAMETERS ARE SHOWN FOR ROGERS RO4350B WITH DIELECTRIC THICKNESS .010"±.001". COPPER: 1/2 OZ. EACH SIDE. FOR OTHER MATERIALS TRACE WIDTH & GAP MAY NEED TO BE MODIFIED.
2. CHIP COMPONENT FOOT PRINTS SHOWN FOR REFERENCE. FOR COMPONENT VALUES REFER TO TB-994+.
3. BOTTOM SIDE OF THE PCB IS CONTINUOUS GROUND PLANE.

- DENOTES PCB COPPER LAYOUT WITH SMOBC (SOLDER MASK OVER BARE COPPER).
- DENOTES COPPER LAND PATTERN FREE OF SOLDER MASK.

Product Marking

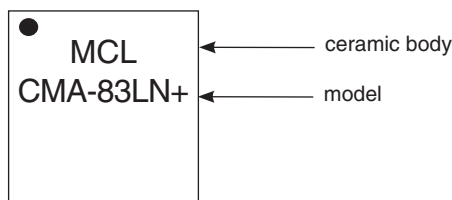

Additional Detailed Technical Information	
<i>additional information is available on our dash board. To access this information click here</i>	
Performance Data	Data Table
	Swept Graphs
	S-Parameter (S2P Files) Data Set (.zip file)
Case Style	DL1721 <i>Ceramic package, exposed paddle, Terminal finish: NiPdAu</i>
Tape & Reel Standard quantities available on reel	F66-1 <i>7" reels with 20, 50, 100, 200, 500 or 1K, 2K devices.</i>
Suggested Layout for PCB Design	PL-606
Evaluation Board	TB-994+
Environmental Ratings	ENV-71

ESD Rating

Human Body Model (HBM): Class 1A (250 to <500V) in accordance with ANSI/ESD STM 5.1 - 2001

Machine Model (MM): Class M1 (pass 50V) in accordance with ANSI/ESD STM5.2-1999

MSL Rating

Moisture Sensitivity: MSL1 (these parts are hermetic, air cavity and therefore, MSL ratings do not strictly apply. For handling purpose, use MSL1)

Qualification Testing

The table below shows the initial qualification testing performed. If required, parts can be subjected to 100% screening and qualifications testing per MIL standard requirement.

Test Description		Test Method/Process	Results
1	Hermeticity (fine and gross leak)	MIL-STD-202 Method 112, Cond. C & D	Pass
2	Acceleration, 30Kg, Y1 Direction	MIL-STD-883 Method 2001 Cond. E	Pass
3	Vibration , 10-2000Hz sine, 20g, 3 axis	MIL-STD-202 Method 204, Cond. D	Pass
4	Mechanical shock	MIL-STD-202 Method 213, Cond . A	Pass
5	PIND 20G's @ 130 Hz	MIL-STD-750 Method 2052.2	Pass
6	Temp Cycle -55C/+125C, 1000 Cycles	MIL-STD-202 Method 107	Pass
7	Autoclave, 121C, RH 100%, 15 Psig, 96 hrs	JESD22-A102C	Pass
8	HTOL, 1000hrs, 105C at rated Voltage condition	MIL-STD-202 Method 108, Cond . D	Pass
9	Bend Test	JESD22-B113	Pass
10	Resistance to soldering heat, 3x reflow, 260C peak	JESD22-B102	Pass
11	Drop Test	JESD22-B111	Pass
12	Adhesion Strength	Push Test>10 lb	Pass

Additional Notes

- A. Performance and quality attributes and conditions not expressly stated in this specification document are intended to be excluded and do not form a part of this specification document.
- B. Electrical specifications and performance data contained in this specification document are based on Mini-Circuit's applicable established test performance criteria and measurement instructions.
- C. The parts covered by this specification document are subject to Mini-Circuits standard limited warranty and terms and conditions (collectively, "Standard Terms"); Purchasers of this part are entitled to the rights and benefits contained therein. For a full statement of the Standard Terms and the exclusive rights and remedies thereunder, please visit Mini-Circuits' website at www.minicircuits.com/MCLStore/terms.jsp



Typical Performance Data

NOTE: Use PDF Bookmarks to view DATA at required conditions

Definitions:

Input Return Loss = -S11 (dB)

Gain(Power Gain) = S21 (dB)

Reverse Isolation = -S12 (dB)

Output Return Loss = -S22 (dB)

TEST CONDITIONS: Vd = 6.00V, Id = 63.81mA @ Temperature = +25°C

FREQ	Gain	Isolation	Input Return Loss	Output Return Loss	Stability		IP-3 Output	1dB Comp. Output	Noise Figure
					K	Measure			
(MHz)	(dB)	(dB)	(dB)	(dB)	K	Measure	(dBm)	(dBm)	(dB)
400	20.35	27.43	7.98	10.15	1.15	0.79	28.74	16.96	1.91
600	21.48	26.16	17.85	16.16	1.11	0.66	30.38	18.47	1.44
800	21.68	25.90	33.38	15.28	1.10	0.59	31.43	19.76	1.31
1000	21.71	25.83	26.15	14.28	1.09	0.57	32.28	20.49	1.27
1200	21.69	25.81	22.30	13.94	1.09	0.56	33.03	20.72	1.30
1400	21.65	25.82	20.58	14.03	1.09	0.57	33.17	20.95	1.29
1600	21.59	25.86	19.67	14.38	1.10	0.58	32.08	20.74	1.38
1800	21.57	25.86	18.67	14.84	1.10	0.59	31.82	20.67	1.38
2000	21.51	25.89	18.05	15.63	1.10	0.61	30.54	20.49	1.34
2200	21.45	25.93	17.38	16.62	1.11	0.63	31.05	20.20	1.35
2400	21.38	25.99	16.64	17.85	1.12	0.65	31.36	20.40	1.36
2600	21.28	26.07	16.00	19.39	1.13	0.68	30.01	19.89	1.37
2800	21.18	26.16	15.31	21.57	1.14	0.70	29.99	19.85	1.41
3000	21.12	26.22	14.43	24.80	1.14	0.72	28.90	19.27	1.43
3200	21.07	26.26	13.57	29.73	1.14	0.74	29.55	19.48	1.42
3400	20.99	26.34	12.86	40.87	1.15	0.76	29.24	19.23	1.41
3600	20.91	26.43	12.21	35.70	1.15	0.78	29.28	19.31	1.46
3800	20.82	26.53	11.59	27.72	1.16	0.80	28.60	19.07	1.42
4000	20.73	26.61	11.05	23.68	1.16	0.81	28.60	18.55	1.51
4200	20.62	26.74	10.57	20.96	1.17	0.83	28.58	18.51	1.51
4400	20.52	26.90	10.02	18.66	1.18	0.84	28.21	18.25	1.52
4600	20.41	27.01	9.59	16.96	1.19	0.85	28.37	18.51	1.50
4800	20.30	27.22	9.20	15.72	1.20	0.86	27.85	18.64	1.51
5000	20.21	27.38	8.85	14.48	1.21	0.87	27.48	19.11	1.54
5200	20.08	27.54	8.47	13.41	1.22	0.88	27.29	18.69	1.49
5400	19.98	27.71	8.18	12.50	1.23	0.88	27.05	18.53	1.53
5600	19.90	27.93	7.92	11.71	1.24	0.88	27.79	19.05	1.56
5800	19.80	28.07	7.74	10.94	1.25	0.88	27.62	19.02	1.63
6000	19.74	28.33	7.46	10.18	1.26	0.87	26.87	18.77	1.58
6200	19.66	28.59	7.25	9.54	1.27	0.87	26.56	18.35	1.58
6400	19.54	28.72	7.10	8.99	1.27	0.87	26.80	18.26	1.62
6600	19.48	29.04	6.93	8.46	1.28	0.86	27.05	18.46	1.65
6800	19.27	29.26	6.85	8.27	1.31	0.87	26.44	17.94	1.68
7000	19.37	29.54	6.85	8.02	1.32	0.87	26.47	17.80	1.62
7200	19.13	29.94	6.79	7.52	1.36	0.86	26.29	17.55	1.72
7400	19.17	29.88	6.41	7.06	1.28	0.86	26.17	17.28	1.70
7600	19.17	30.06	6.27	6.67	1.25	0.85	26.22	17.37	1.76
7800	19.13	30.15	6.16	6.37	1.22	0.85	25.95	17.04	1.75
8000	19.03	30.19	6.02	6.14	1.18	0.86	26.20	16.77	1.88



Typical Performance Data

Definitions:

Input Return Loss = -S11 (dB)

Gain(Power Gain) = S21 (dB)

Reverse Isolation = -S12 (dB)

Output Return Loss = -S22 (dB)

TEST CONDITIONS: Vd = 5.00V, Id = 50.75mA @ Temperature = +25°C

FREQ	Gain	Isolation	Input Return Loss	Output Return Loss	Stability		IP-3 Output	1dB Comp. Output	Noise Figure
					K	Measure			
(MHz)	(dB)	(dB)	(dB)	(dB)	K	Measure	(dBm)	(dBm)	(dB)
400	19.43	26.71	7.48	10.32	1.16	0.81	25.58	14.58	1.93
600	20.61	25.39	15.77	17.89	1.11	0.68	26.81	15.82	1.48
800	20.84	25.10	25.49	17.71	1.10	0.62	27.45	17.04	1.35
1000	20.89	25.01	28.53	16.51	1.10	0.59	28.05	18.40	1.26
1200	20.88	25.00	24.21	16.06	1.10	0.58	28.56	18.83	1.33
1400	20.85	25.01	21.59	16.18	1.10	0.59	28.57	19.21	1.31
1600	20.78	25.07	19.93	16.60	1.10	0.61	28.24	19.03	1.39
1800	20.76	25.09	18.51	17.20	1.10	0.62	27.92	19.09	1.41
2000	20.70	25.13	17.47	18.24	1.11	0.64	27.16	19.18	1.34
2200	20.64	25.19	16.51	19.57	1.11	0.66	27.47	18.57	1.37
2400	20.56	25.27	15.60	21.32	1.12	0.68	27.70	18.75	1.42
2600	20.47	25.37	14.85	23.65	1.13	0.71	26.68	18.09	1.46
2800	20.36	25.48	14.10	27.41	1.14	0.73	26.64	17.62	1.51
3000	20.30	25.56	13.25	35.05	1.14	0.75	25.71	17.17	1.39
3200	20.25	25.62	12.45	39.28	1.14	0.77	26.25	17.38	1.52
3400	20.17	25.71	11.80	29.78	1.15	0.79	26.00	16.73	1.52
3600	20.09	25.83	11.22	25.02	1.15	0.80	26.00	16.92	1.49
3800	20.01	25.94	10.67	21.93	1.16	0.82	25.47	16.64	1.46
4000	19.93	26.04	10.19	19.72	1.16	0.83	25.41	15.97	1.50
4200	19.82	26.18	9.77	17.98	1.17	0.84	25.46	15.80	1.56
4400	19.72	26.36	9.28	16.36	1.18	0.86	25.11	15.33	1.54
4600	19.62	26.48	8.90	15.10	1.18	0.87	25.35	15.76	1.54
4800	19.53	26.70	8.55	14.15	1.19	0.88	24.87	15.98	1.62
5000	19.44	26.86	8.24	13.17	1.20	0.88	24.42	16.58	1.63
5200	19.33	27.03	7.91	12.29	1.21	0.89	24.30	16.57	1.60
5400	19.24	27.21	7.64	11.55	1.22	0.89	24.18	16.64	1.65
5600	19.17	27.43	7.42	10.89	1.23	0.89	24.89	17.61	1.62
5800	19.09	27.58	7.26	10.24	1.23	0.88	24.76	17.58	1.58
6000	19.03	27.84	7.01	9.59	1.24	0.88	24.07	17.59	1.67
6200	18.97	28.10	6.82	9.06	1.25	0.88	23.65	17.21	1.64
6400	18.87	28.25	6.68	8.56	1.25	0.87	23.99	17.00	1.65
6600	18.82	28.56	6.53	8.11	1.26	0.87	24.28	17.51	1.64
6800	18.63	28.79	6.45	7.95	1.28	0.88	23.73	17.02	1.77
7000	18.75	29.06	6.46	7.77	1.29	0.88	23.85	16.86	1.78
7200	18.53	29.48	6.42	7.31	1.34	0.87	23.77	16.67	2.00
7400	18.58	29.46	6.02	6.89	1.26	0.87	23.76	16.45	1.81
7600	18.60	29.64	5.89	6.56	1.23	0.87	23.86	16.69	1.80
7800	18.57	29.77	5.79	6.28	1.20	0.87	23.84	16.42	1.80
8000	18.49	29.85	5.64	6.07	1.17	0.87	24.32	16.11	1.86

Typical Performance Data

Definitions:

Input Return Loss = -S11 (dB)

Gain(Power Gain) = S21 (dB)

Reverse Isolation = -S12 (dB)

Output Return Loss = -S22 (dB)

TEST CONDITIONS: Vd = 6.25V, Id = 67.35mA @ Temperature = +25°C

FREQ	Gain	Isolation	Input Return Loss	Output Return Loss	Stability		IP-3 Output	1dB Comp. Output	Noise Figure
					K	Measure			
(MHz)	(dB)	(dB)	(dB)	(dB)	K	Measure	(dBm)	(dBm)	(dB)
400	20.57	27.62	8.02	10.10	1.15	0.79	29.36	17.65	1.88
600	21.70	26.37	18.06	15.94	1.11	0.66	31.09	19.01	1.45
800	21.89	26.10	34.22	15.04	1.09	0.59	32.13	20.17	1.31
1000	21.92	26.03	25.78	14.07	1.09	0.56	33.31	20.80	1.24
1200	21.89	26.01	22.08	13.75	1.09	0.56	33.89	21.08	1.29
1400	21.86	26.02	20.43	13.84	1.09	0.56	34.33	21.31	1.30
1600	21.80	26.06	19.59	14.18	1.10	0.58	32.96	21.09	1.34
1800	21.77	26.06	18.64	14.64	1.10	0.59	32.61	21.02	1.38
2000	21.71	26.09	18.06	15.41	1.10	0.61	31.44	20.84	1.31
2200	21.65	26.12	17.40	16.37	1.11	0.63	31.68	20.58	1.36
2400	21.57	26.18	16.69	17.57	1.12	0.65	32.14	20.75	1.40
2600	21.48	26.25	16.04	19.07	1.13	0.68	30.75	20.26	1.41
2800	21.37	26.34	15.37	21.16	1.14	0.70	30.71	20.21	1.49
3000	21.31	26.40	14.50	24.22	1.14	0.72	29.62	19.64	1.39
3200	21.25	26.44	13.62	28.80	1.14	0.74	30.14	19.86	1.46
3400	21.17	26.51	12.91	38.24	1.15	0.76	29.91	19.67	1.49
3600	21.08	26.61	12.25	37.93	1.15	0.78	29.81	19.68	1.47
3800	20.99	26.70	11.63	28.43	1.16	0.80	29.33	19.35	1.44
4000	20.90	26.78	11.08	24.12	1.16	0.81	29.21	18.99	1.49
4200	20.78	26.91	10.61	21.28	1.17	0.83	29.17	18.94	1.55
4400	20.67	27.07	10.06	18.88	1.18	0.84	28.75	18.72	1.52
4600	20.56	27.17	9.62	17.14	1.19	0.85	28.93	18.97	1.52
4800	20.45	27.38	9.23	15.86	1.20	0.86	28.48	19.09	1.62
5000	20.35	27.53	8.87	14.59	1.21	0.87	28.11	19.53	1.60
5200	20.23	27.69	8.50	13.50	1.22	0.88	27.89	19.05	1.57
5400	20.12	27.86	8.21	12.57	1.23	0.88	27.59	18.86	1.58
5600	20.03	28.08	7.95	11.75	1.25	0.88	28.26	19.23	1.59
5800	19.93	28.22	7.76	10.98	1.25	0.88	28.18	19.16	1.54
6000	19.86	28.48	7.49	10.21	1.26	0.88	27.42	18.89	1.62
6200	19.78	28.74	7.28	9.56	1.27	0.87	27.09	18.59	1.64
6400	19.65	28.86	7.14	9.00	1.27	0.87	27.30	18.46	1.66
6600	19.58	29.17	6.97	8.46	1.29	0.86	27.59	18.60	1.62
6800	19.37	29.39	6.89	8.27	1.31	0.88	26.93	18.08	1.73
7000	19.47	29.66	6.89	8.01	1.32	0.87	26.94	17.92	1.77
7200	19.23	30.04	6.83	7.51	1.36	0.86	26.70	17.68	1.96
7400	19.26	29.97	6.46	7.04	1.28	0.86	26.55	17.39	1.77
7600	19.26	30.13	6.30	6.66	1.25	0.85	26.62	17.37	1.74
7800	19.21	30.20	6.20	6.35	1.21	0.85	26.36	17.11	1.80
8000	19.10	30.22	6.06	6.12	1.17	0.86	26.55	16.86	1.84

Typical Performance Data

Definitions:

Input Return Loss = -S11 (dB)

Gain(Power Gain) = S21 (dB)

Reverse Isolation = -S12 (dB)

Output Return Loss = -S22 (dB)

TEST CONDITIONS: Vd = 6.00V, Id = 72.73mA @ Temperature = -45°C

FREQ	Gain	Isolation	Input Return Loss	Output Return Loss	Stability		IP-3 Output	1dB Comp. Output	Noise Figure
					K	Measure			
(MHz)	(dB)	(dB)	(dB)	(dB)	K	Measure	(dBm)	(dBm)	(dB)
400	19.97	26.72	10.33	9.01	1.13	0.71	31.81	19.31	1.46
600	20.86	25.70	26.69	10.71	1.10	0.57	33.13	21.34	1.13
800	20.92	25.56	16.30	9.77	1.09	0.51	33.83	21.91	1.05
1000	20.91	25.52	13.94	9.26	1.08	0.49	34.20	22.13	0.98
1200	20.89	25.51	13.17	9.08	1.08	0.48	32.38	22.20	1.03
1400	20.84	25.52	12.52	8.84	1.08	0.48	31.85	22.30	1.02
1600	20.83	25.52	12.62	8.98	1.08	0.49	31.69	22.33	1.10
1800	20.85	25.49	12.78	9.14	1.08	0.49	32.69	22.37	1.11
2000	20.87	25.45	13.28	9.53	1.08	0.50	31.81	22.12	1.02
2200	20.88	25.42	13.88	9.89	1.09	0.51	30.96	21.93	1.03
2400	20.87	25.41	14.25	10.19	1.09	0.52	31.20	22.07	1.11
2600	20.85	25.42	15.08	10.71	1.10	0.53	31.76	21.90	1.12
2800	20.84	25.43	16.11	11.54	1.10	0.56	32.10	21.72	1.19
3000	20.88	25.39	17.92	12.74	1.11	0.58	31.02	20.89	1.06
3200	20.94	25.33	19.20	13.60	1.10	0.58	30.92	20.83	1.11
3400	20.95	25.32	19.94	14.39	1.10	0.59	30.87	20.55	1.11
3600	20.96	25.33	20.78	15.62	1.11	0.61	30.79	20.26	1.10
3800	20.96	25.34	20.63	17.24	1.11	0.62	30.26	19.44	1.06
4000	20.97	25.35	20.13	19.41	1.11	0.64	29.97	18.47	1.09
4200	20.94	25.40	19.60	21.25	1.12	0.65	29.42	18.27	1.12
4400	20.92	25.47	18.56	23.48	1.12	0.66	29.32	17.78	1.08
4600	20.90	25.50	17.90	26.67	1.12	0.67	29.08	18.07	1.09
4800	20.88	25.63	16.47	33.06	1.13	0.69	28.63	17.68	1.15
5000	20.86	25.71	15.41	33.75	1.13	0.70	28.83	17.96	1.15
5200	20.80	25.81	14.29	28.03	1.14	0.72	28.35	17.26	1.15
5400	20.78	25.92	13.63	23.70	1.15	0.72	27.32	16.80	1.25
5600	20.76	26.09	12.70	20.58	1.15	0.73	28.62	17.91	1.15
5800	20.71	26.23	11.72	17.60	1.16	0.74	28.71	18.05	1.09
6000	20.68	26.43	10.91	15.54	1.17	0.74	27.88	17.43	1.16
6200	20.66	26.67	10.29	14.07	1.18	0.74	27.73	17.05	1.16
6400	20.59	26.85	9.94	12.88	1.18	0.74	28.00	16.98	1.19
6600	20.54	27.13	9.20	11.53	1.19	0.74	28.75	18.31	1.16
6800	20.42	27.36	8.99	10.70	1.21	0.74	28.00	17.85	1.25
7000	20.42	27.79	8.78	11.07	1.24	0.78	28.15	18.04	1.24
7200	20.38	28.18	8.63	9.93	1.27	0.76	28.00	17.86	1.46
7400	20.49	28.27	8.39	9.16	1.25	0.74	27.66	17.58	1.28
7600	20.56	28.68	8.30	8.51	1.26	0.73	28.20	18.24	1.26
7800	20.63	29.01	8.31	8.07	1.27	0.72	27.74	18.13	1.24
8000	20.68	29.30	8.22	7.77	1.27	0.72	27.86	17.74	1.31

Typical Performance Data

Definitions:

Input Return Loss = -S11 (dB)

Gain(Power Gain) = S21 (dB)

Reverse Isolation = -S12 (dB)

Output Return Loss = -S22 (dB)

TEST CONDITIONS: Vd = 5.00V, Id = 55.19mA @ Temperature = -45°C

FREQ	Gain	Isolation	Input Return Loss	Output Return Loss	Stability		IP-3 Output	1dB Comp. Output	Noise Figure
					K	Measure			
(MHz)	(dB)	(dB)	(dB)	(dB)	K	Measure	(dBm)	(dBm)	(dB)
400	19.07	25.93	9.43	9.76	1.15	0.75	26.78	14.97	1.50
600	20.04	24.82	31.99	12.58	1.11	0.61	28.73	17.90	1.13
800	20.16	24.64	20.12	11.51	1.10	0.55	30.00	19.81	1.07
1000	20.17	24.60	16.60	10.88	1.09	0.53	31.31	20.21	1.00
1200	20.15	24.59	15.50	10.65	1.09	0.52	31.99	20.26	1.10
1400	20.12	24.61	14.57	10.35	1.09	0.52	32.60	20.39	1.07
1600	20.10	24.63	14.56	10.51	1.09	0.53	30.54	20.41	1.16
1800	20.11	24.62	14.66	10.72	1.09	0.53	30.47	20.46	1.15
2000	20.12	24.61	15.10	11.20	1.10	0.54	28.53	20.27	1.06
2200	20.12	24.61	15.64	11.65	1.10	0.55	28.70	19.84	1.06
2400	20.11	24.63	15.84	12.03	1.10	0.57	29.43	20.00	1.13
2600	20.08	24.67	16.58	12.68	1.11	0.59	28.10	19.89	1.15
2800	20.05	24.72	17.32	13.72	1.12	0.61	28.17	19.67	1.19
3000	20.08	24.73	18.25	15.31	1.12	0.63	26.54	18.93	1.09
3200	20.13	24.70	18.54	16.46	1.12	0.64	27.18	18.79	1.16
3400	20.13	24.72	18.37	17.54	1.12	0.65	26.92	18.23	1.11
3600	20.14	24.76	18.17	19.21	1.12	0.66	26.86	17.91	1.12
3800	20.13	24.81	17.34	21.54	1.12	0.68	26.15	16.84	1.07
4000	20.13	24.85	16.61	24.71	1.12	0.69	25.99	16.00	1.13
4200	20.11	24.92	16.13	27.20	1.13	0.70	25.86	15.64	1.13
4400	20.09	25.01	15.43	28.40	1.13	0.71	25.50	15.03	1.11
4600	20.07	25.07	15.02	26.42	1.14	0.72	25.64	15.46	1.10
4800	20.04	25.22	14.06	24.77	1.14	0.73	25.04	15.06	1.20
5000	20.03	25.34	13.32	22.61	1.15	0.74	24.89	15.65	1.17
5200	19.98	25.46	12.51	20.71	1.15	0.75	24.56	15.11	1.16
5400	19.96	25.59	12.06	18.81	1.16	0.76	23.98	14.93	1.20
5600	19.95	25.77	11.34	17.17	1.17	0.77	25.18	16.03	1.17
5800	19.90	25.93	10.57	15.25	1.17	0.77	25.11	16.16	1.12
6000	19.88	26.14	9.92	13.84	1.18	0.77	24.23	16.03	1.18
6200	19.87	26.39	9.42	12.76	1.19	0.77	23.95	15.64	1.18
6400	19.82	26.58	9.13	11.81	1.19	0.77	24.21	15.56	1.19
6600	19.77	26.86	8.50	10.75	1.20	0.77	24.84	16.81	1.17
6800	19.68	27.09	8.33	10.07	1.22	0.77	24.21	16.78	1.28
7000	19.70	27.49	8.15	10.50	1.25	0.80	24.32	17.29	1.28
7200	19.68	27.88	8.08	9.54	1.28	0.78	24.37	17.44	1.48
7400	19.81	27.98	7.80	8.90	1.25	0.76	24.24	17.15	1.29
7600	19.90	28.37	7.69	8.33	1.26	0.76	24.73	18.17	1.26
7800	19.99	28.68	7.67	7.97	1.26	0.75	24.60	18.13	1.28
8000	20.06	28.98	7.57	7.72	1.27	0.76	25.29	17.61	1.31

Typical Performance Data

Definitions:

Input Return Loss = -S11 (dB)

Gain(Power Gain) = S21 (dB)

Reverse Isolation = -S12 (dB)

Output Return Loss = -S22 (dB)

TEST CONDITIONS: Vd = 6.25V, Id = 76.65mA @ Temperature = -45°C

FREQ	Gain	Isolation	Input Return Loss	Output Return Loss	Stability		IP-3 Output	1dB Comp. Output	Noise Figure
					K	Measure			
(MHz)	(dB)	(dB)	(dB)	(dB)	K	Measure	(dBm)	(dBm)	(dB)
400	20.14	26.85	10.47	8.91	1.13	0.70	32.60	20.25	1.44
600	21.01	25.85	25.52	10.52	1.10	0.57	33.37	21.83	1.13
800	21.07	25.71	15.89	9.59	1.08	0.51	33.16	22.38	1.05
1000	21.05	25.68	13.65	9.10	1.08	0.49	33.42	22.56	1.02
1200	21.02	25.66	12.91	8.92	1.08	0.48	31.98	22.64	1.05
1400	20.98	25.68	12.30	8.69	1.08	0.47	31.59	22.74	1.02
1600	20.96	25.67	12.41	8.82	1.08	0.48	31.56	22.76	1.10
1800	20.98	25.64	12.57	8.98	1.08	0.48	32.26	22.81	1.13
2000	21.00	25.59	13.09	9.36	1.08	0.49	31.87	22.57	1.03
2200	21.02	25.56	13.68	9.71	1.08	0.50	30.96	22.43	1.05
2400	21.01	25.55	14.05	10.00	1.09	0.51	31.26	22.54	1.10
2600	21.00	25.55	14.89	10.52	1.09	0.53	32.12	22.42	1.08
2800	20.98	25.56	15.93	11.33	1.10	0.55	32.24	22.24	1.13
3000	21.03	25.51	17.84	12.50	1.10	0.57	31.49	21.47	1.06
3200	21.09	25.45	19.19	13.33	1.10	0.57	31.40	21.39	1.09
3400	21.10	25.43	20.05	14.11	1.10	0.59	31.30	21.15	1.12
3600	21.11	25.44	21.08	15.30	1.10	0.60	31.33	20.86	1.08
3800	21.11	25.44	21.09	16.87	1.11	0.62	30.83	20.17	1.05
4000	21.11	25.45	20.65	18.98	1.11	0.63	30.47	19.20	1.09
4200	21.08	25.49	20.11	20.76	1.11	0.64	30.06	18.99	1.12
4400	21.06	25.56	18.98	22.92	1.12	0.66	29.87	18.51	1.07
4600	21.04	25.59	18.29	26.24	1.12	0.67	29.58	18.77	1.08
4800	21.02	25.71	16.77	33.30	1.13	0.68	29.14	18.35	1.14
5000	20.99	25.80	15.64	37.18	1.13	0.70	29.35	18.61	1.15
5200	20.94	25.90	14.47	29.27	1.14	0.71	28.99	17.90	1.16
5400	20.91	26.00	13.79	24.31	1.15	0.72	27.82	17.38	1.15
5600	20.89	26.17	12.84	20.89	1.15	0.73	29.18	18.42	1.15
5800	20.84	26.31	11.82	17.79	1.16	0.73	29.20	18.58	1.09
6000	20.81	26.50	10.99	15.66	1.16	0.74	28.44	17.96	1.17
6200	20.78	26.74	10.37	14.14	1.17	0.74	28.36	17.50	1.15
6400	20.71	26.93	10.02	12.92	1.18	0.74	28.59	17.42	1.18
6600	20.66	27.20	9.25	11.56	1.19	0.74	29.37	18.71	1.15
6800	20.53	27.44	9.04	10.71	1.21	0.74	28.55	18.12	1.25
7000	20.53	27.87	8.82	11.05	1.24	0.78	28.70	18.30	1.25
7200	20.49	28.26	8.67	9.90	1.27	0.76	28.55	18.07	1.46
7400	20.60	28.35	8.44	9.13	1.25	0.73	28.22	17.81	1.26
7600	20.66	28.78	8.34	8.46	1.26	0.73	28.74	18.36	1.24
7800	20.72	29.09	8.36	8.02	1.27	0.72	28.15	18.23	1.22
8000	20.77	29.39	8.26	7.72	1.27	0.72	28.14	17.81	1.28

Typical Performance Data

Definitions:

Input Return Loss = -S11 (dB)

Gain(Power Gain) = S21 (dB)

Reverse Isolation = -S12 (dB)

Output Return Loss = -S22 (dB)

TEST CONDITIONS: Vd = 6.00V, Id = 46.88mA @ Temperature = +125°C

FREQ	Gain	Isolation	Input Return Loss	Output Return Loss	Stability		IP-3 Output	1dB Comp. Output	Noise Figure
					K	Measure			
(MHz)	(dB)	(dB)	(dB)	(dB)	K	Measure	(dBm)	(dBm)	(dB)
400	20.04	28.73	5.14	8.66	1.18	0.86	25.36	18.17	2.60
600	21.51	27.17	8.72	14.23	1.13	0.75	26.29	18.97	1.95
800	21.92	26.70	11.08	18.31	1.11	0.69	26.62	19.73	1.76
1000	22.01	26.55	11.85	20.16	1.10	0.68	27.02	20.43	1.70
1200	21.97	26.54	11.63	20.15	1.10	0.68	27.26	20.45	1.73
1400	21.87	26.59	10.96	19.32	1.10	0.70	27.10	20.67	1.73
1600	21.71	26.69	10.19	18.62	1.10	0.73	26.91	20.51	1.80
1800	21.60	26.74	9.63	17.77	1.10	0.75	26.73	20.54	1.83
2000	21.44	26.84	9.07	16.99	1.10	0.77	26.43	20.76	1.78
2200	21.27	26.93	8.62	16.41	1.11	0.80	26.80	20.25	1.83
2400	21.10	27.04	8.24	15.93	1.11	0.83	26.84	20.39	1.89
2600	20.91	27.16	7.91	15.52	1.12	0.85	26.15	20.17	1.91
2800	20.71	27.30	7.59	15.03	1.13	0.88	26.05	20.05	2.01
3000	20.52	27.41	7.25	14.39	1.13	0.90	25.49	19.93	1.92
3200	20.33	27.53	6.92	13.68	1.13	0.93	26.03	19.85	2.06
3400	20.11	27.67	6.63	12.97	1.14	0.95	25.78	19.50	2.05
3600	19.88	27.84	6.34	12.23	1.14	0.97	25.67	19.57	2.08
3800	19.64	28.00	5.99	11.39	1.14	0.98	25.19	19.47	2.09
4000	19.38	28.17	5.68	10.68	1.14	1.00	25.20	19.02	2.14
4200	19.11	28.35	5.46	10.06	1.15	1.01	25.23	18.75	2.21
4400	18.85	28.57	5.17	9.36	1.15	1.01	24.84	18.46	2.24
4600	18.60	28.70	4.95	8.85	1.16	1.02	24.89	18.17	2.26
4800	18.37	28.89	4.76	8.39	1.16	1.02	24.38	17.91	2.33
5000	18.17	29.02	4.63	7.96	1.16	1.02	23.62	17.58	2.36
5200	17.97	29.07	4.55	7.64	1.16	1.01	23.59	16.96	2.36
5400	17.83	29.13	4.49	7.36	1.15	1.01	23.64	16.59	2.37
5600	17.70	29.24	4.43	7.07	1.15	1.00	23.63	16.21	2.38
5800	17.57	29.14	4.46	6.84	1.13	0.99	23.29	15.71	2.30
6000	17.47	29.14	4.44	6.58	1.10	0.99	22.74	15.56	2.40
6200	17.36	29.07	4.46	6.36	1.08	0.98	22.32	15.22	2.40
6400	17.22	28.93	4.52	6.21	1.06	0.97	22.41	14.72	2.42
6600	17.06	28.93	4.49	6.06	1.03	0.98	22.21	14.33	2.40
6800	16.92	28.89	4.48	6.02	1.02	0.99	21.74	14.04	2.55
7000	16.74	28.71	4.63	5.75	1.00	0.97	21.56	13.71	2.63
7200	16.36	28.69	4.62	5.57	1.00	0.96	21.33	13.44	2.78
7400	16.28	28.46	4.26	5.30	0.89	0.97	21.31	13.08	2.63
7600	16.07	28.18	4.17	5.09	0.83	0.97	20.81	12.89	2.67
7800	15.80	27.92	4.11	4.91	0.78	0.97	20.72	12.63	2.69
8000	15.53	27.73	4.04	4.77	0.75	0.97	20.91	12.27	2.77

Typical Performance Data

Definitions:

Input Return Loss = -S11 (dB)

Gain(Power Gain) = S21 (dB)

Reverse Isolation = -S12 (dB)

Output Return Loss = -S22 (dB)

TEST CONDITIONS: Vd = 5.00V, Id = 37.29mA @ Temperature = +125°C

FREQ	Gain	Isolation	Input Return Loss	Output Return Loss	Stability		IP-3 Output	1dB Comp. Output	Noise Figure
					K	Measure			
(MHz)	(dB)	(dB)	(dB)	(dB)	K	Measure	(dBm)	(dBm)	(dB)
400	18.87	27.97	4.84	8.23	1.19	0.86	23.06	18.11	2.70
600	20.38	26.36	8.09	12.88	1.14	0.76	23.91	19.07	2.01
800	20.82	25.87	10.20	15.95	1.12	0.70	24.17	19.81	1.84
1000	20.93	25.71	10.89	17.21	1.11	0.68	24.56	20.16	1.72
1200	20.90	25.70	10.72	17.18	1.10	0.69	24.73	20.01	1.79
1400	20.81	25.75	10.14	16.60	1.10	0.71	24.62	20.16	1.80
1600	20.66	25.87	9.47	16.11	1.10	0.74	24.47	20.11	1.87
1800	20.56	25.92	8.98	15.50	1.10	0.76	24.27	20.30	1.89
2000	20.41	26.02	8.48	14.92	1.10	0.78	23.95	20.35	1.84
2200	20.25	26.13	8.06	14.49	1.11	0.81	24.33	19.81	1.88
2400	20.08	26.24	7.71	14.13	1.11	0.83	24.38	19.89	1.95
2600	19.91	26.37	7.42	13.82	1.12	0.86	23.69	20.22	1.98
2800	19.71	26.51	7.13	13.45	1.12	0.88	23.59	19.99	2.08
3000	19.53	26.64	6.81	12.94	1.12	0.91	23.05	20.05	2.00
3200	19.36	26.76	6.50	12.34	1.12	0.93	23.58	19.46	2.10
3400	19.15	26.92	6.24	11.76	1.13	0.95	23.30	19.35	2.09
3600	18.93	27.09	5.96	11.13	1.13	0.96	23.23	19.30	2.13
3800	18.69	27.27	5.64	10.42	1.13	0.98	22.75	19.41	2.13
4000	18.45	27.44	5.35	9.81	1.13	0.99	22.78	18.84	2.19
4200	18.19	27.63	5.14	9.27	1.14	1.00	22.89	18.46	2.28
4400	17.94	27.86	4.87	8.66	1.13	1.00	22.49	18.31	2.30
4600	17.69	28.00	4.67	8.20	1.14	1.00	22.56	18.08	2.31
4800	17.48	28.20	4.48	7.81	1.14	1.01	22.13	17.83	2.45
5000	17.29	28.34	4.36	7.43	1.13	1.00	21.35	17.82	2.44
5200	17.11	28.40	4.28	7.15	1.13	1.00	21.44	17.14	2.44
5400	16.98	28.47	4.22	6.91	1.13	0.99	21.61	16.76	2.42
5600	16.87	28.58	4.17	6.66	1.12	0.99	21.63	16.26	2.43
5800	16.75	28.50	4.19	6.44	1.10	0.98	21.28	15.92	2.40
6000	16.67	28.51	4.17	6.22	1.07	0.97	20.80	15.84	2.45
6200	16.58	28.47	4.19	6.03	1.05	0.97	20.42	15.37	2.47
6400	16.45	28.34	4.24	5.91	1.03	0.96	20.58	14.74	2.46
6600	16.31	28.37	4.22	5.77	1.01	0.97	20.37	14.11	2.49
6800	16.19	28.35	4.21	5.76	0.99	0.98	19.97	13.82	2.61
7000	16.02	28.21	4.36	5.51	0.98	0.96	19.85	13.49	2.69
7200	15.65	28.23	4.36	5.35	0.99	0.95	19.66	13.19	2.85
7400	15.59	28.04	4.01	5.11	0.88	0.96	19.69	12.78	2.68
7600	15.39	27.80	3.92	4.92	0.82	0.96	19.22	12.63	2.76
7800	15.14	27.59	3.87	4.76	0.78	0.96	19.17	12.34	2.74
8000	14.88	27.43	3.81	4.63	0.75	0.96	19.39	11.94	2.85

Typical Performance Data

Definitions:

Input Return Loss = -S11 (dB)

Gain(Power Gain) = S21 (dB)

Reverse Isolation = -S12 (dB)

Output Return Loss = -S22 (dB)

TEST CONDITIONS: Vd = 6.25V, Id = 49.61mA @ Temperature = +125°C

FREQ	Gain	Isolation	Input Return Loss	Output Return Loss	Stability		IP-3 Output	1dB Comp. Output	Noise Figure
					K	Measure			
(MHz)	(dB)	(dB)	(dB)	(dB)	K	Measure	(dBm)	(dBm)	(dB)
400	20.29	28.90	5.21	8.76	1.18	0.86	25.90	18.33	2.59
600	21.75	27.34	8.87	14.56	1.13	0.75	26.89	19.13	1.95
800	22.15	26.88	11.29	18.92	1.11	0.69	27.21	19.81	1.77
1000	22.23	26.74	12.08	20.96	1.10	0.67	27.62	20.36	1.67
1200	22.19	26.73	11.83	20.97	1.10	0.68	27.85	20.42	1.71
1400	22.09	26.77	11.14	20.04	1.10	0.70	27.71	20.69	1.71
1600	21.93	26.87	10.35	19.29	1.10	0.73	27.47	20.56	1.81
1800	21.82	26.92	9.78	18.35	1.10	0.75	27.33	20.58	1.82
2000	21.66	27.01	9.22	17.51	1.10	0.77	27.00	20.77	1.78
2200	21.49	27.11	8.75	16.90	1.11	0.80	27.45	20.32	1.82
2400	21.31	27.21	8.35	16.39	1.11	0.83	27.48	20.40	1.88
2600	21.12	27.33	8.02	15.95	1.12	0.85	26.71	20.17	1.91
2800	20.91	27.46	7.70	15.43	1.13	0.88	26.61	19.92	2.01
3000	20.72	27.58	7.35	14.75	1.13	0.90	26.07	19.80	1.92
3200	20.53	27.69	7.01	14.00	1.13	0.93	26.57	19.81	2.05
3400	20.31	27.83	6.73	13.27	1.14	0.95	26.34	19.47	2.00
3600	20.08	28.00	6.43	12.49	1.14	0.97	26.25	19.52	2.07
3800	19.83	28.16	6.07	11.63	1.14	0.98	25.75	19.37	2.05
4000	19.57	28.32	5.76	10.89	1.15	1.00	25.73	19.09	2.17
4200	19.30	28.50	5.54	10.24	1.16	1.01	25.76	18.85	2.22
4400	19.04	28.71	5.24	9.52	1.16	1.02	25.35	18.50	2.23
4600	18.78	28.85	5.02	8.99	1.16	1.02	25.35	18.27	2.24
4800	18.55	29.03	4.83	8.52	1.17	1.02	24.87	17.86	2.35
5000	18.35	29.16	4.69	8.08	1.16	1.02	24.10	17.45	2.36
5200	18.15	29.21	4.61	7.75	1.17	1.01	24.06	17.01	2.32
5400	18.00	29.27	4.55	7.46	1.16	1.01	24.07	16.67	2.36
5600	17.87	29.36	4.50	7.17	1.15	1.00	24.10	16.22	2.35
5800	17.73	29.27	4.52	6.92	1.13	0.99	23.74	15.84	2.28
6000	17.62	29.26	4.51	6.66	1.11	0.99	23.16	15.68	2.38
6200	17.52	29.18	4.53	6.43	1.08	0.98	22.74	15.31	2.42
6400	17.37	29.04	4.59	6.28	1.06	0.97	22.83	14.85	2.41
6600	17.20	29.03	4.57	6.12	1.04	0.98	22.60	14.46	2.39
6800	17.07	28.99	4.55	6.08	1.02	0.99	22.11	14.15	2.54
7000	16.88	28.81	4.70	5.80	1.00	0.97	21.94	13.85	2.62
7200	16.49	28.77	4.69	5.62	1.01	0.96	21.68	13.56	2.77
7400	16.41	28.54	4.32	5.35	0.90	0.97	21.64	13.19	2.62
7600	16.20	28.24	4.23	5.13	0.83	0.97	21.15	12.99	2.65
7800	15.93	27.98	4.17	4.95	0.79	0.97	21.06	12.77	2.69
8000	15.65	27.77	4.09	4.80	0.75	0.97	21.22	12.39	2.75

Typical Performance Curves

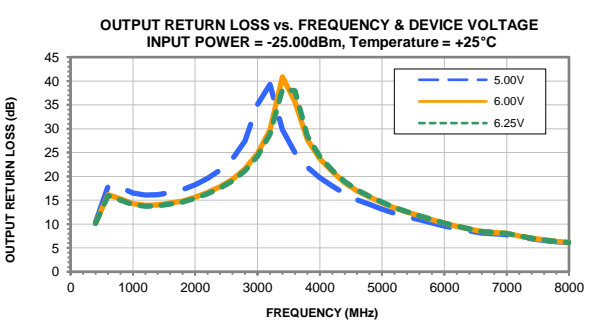
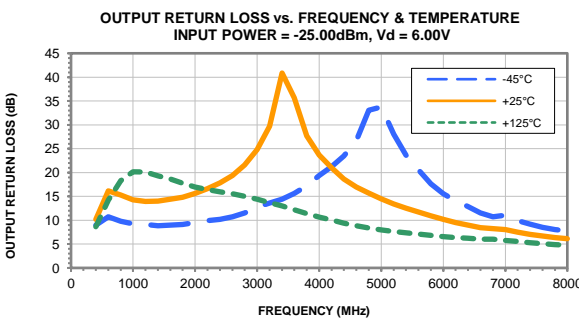
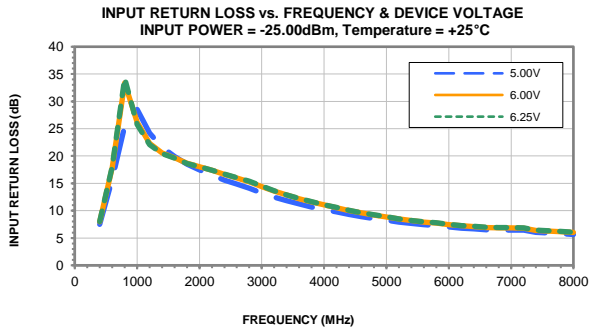
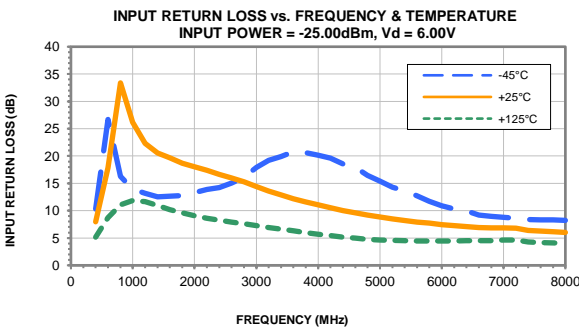
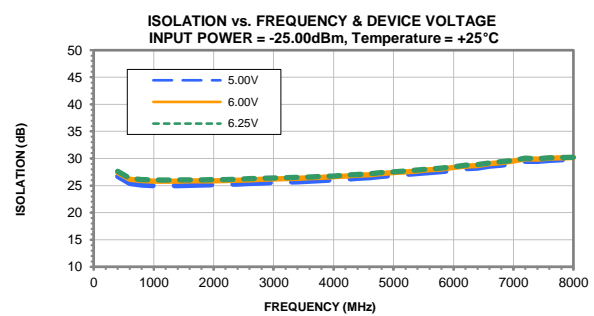
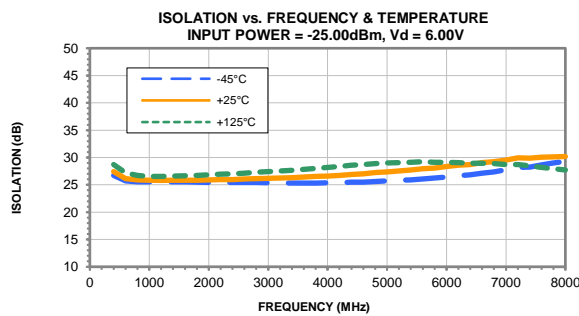
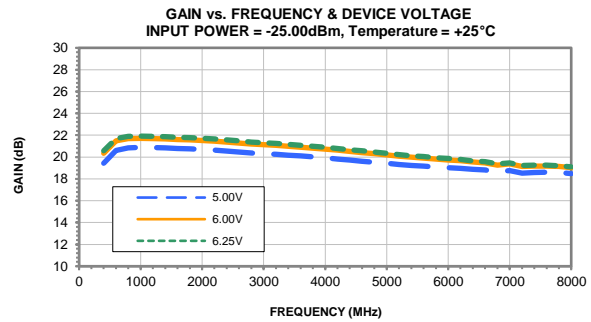
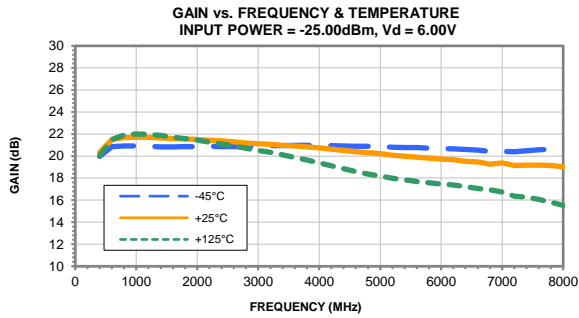

Typical Performance Curves

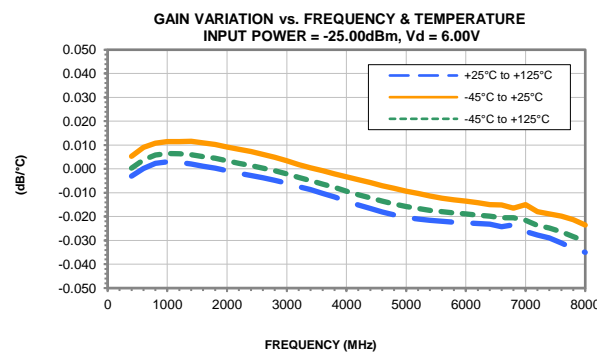
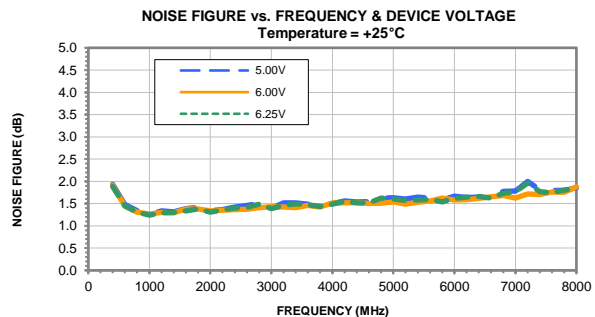
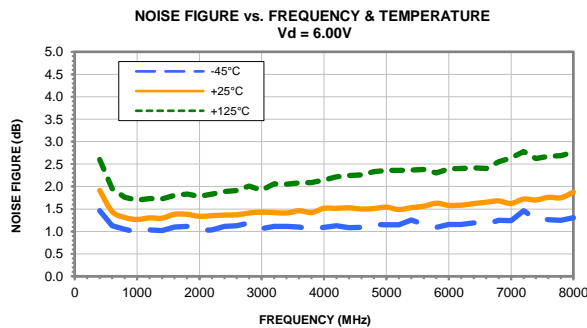
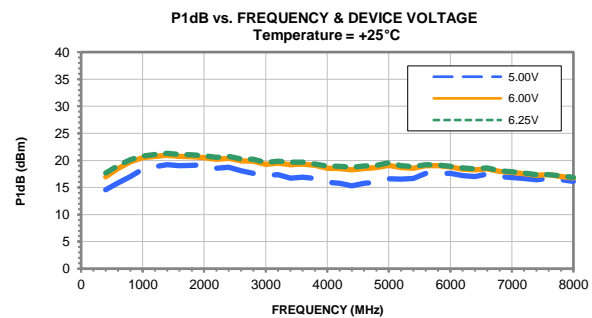
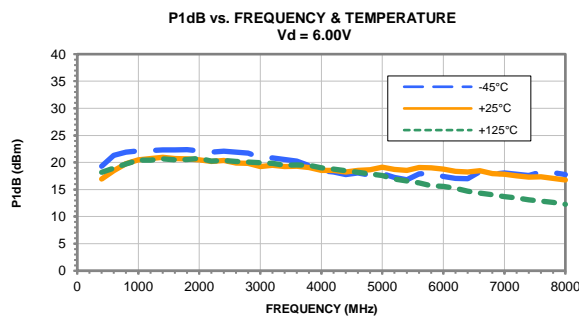
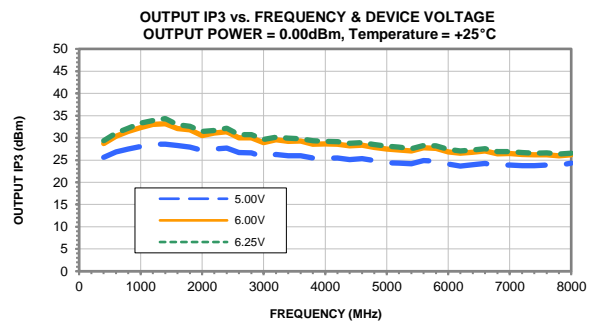
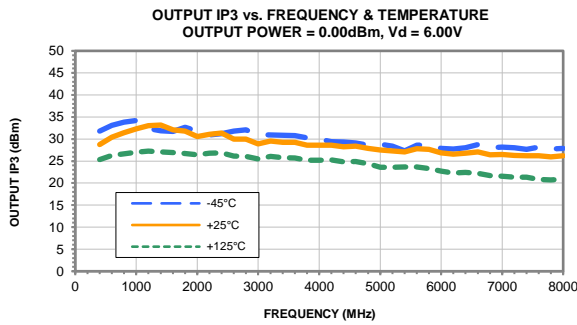

Outline Dimensions

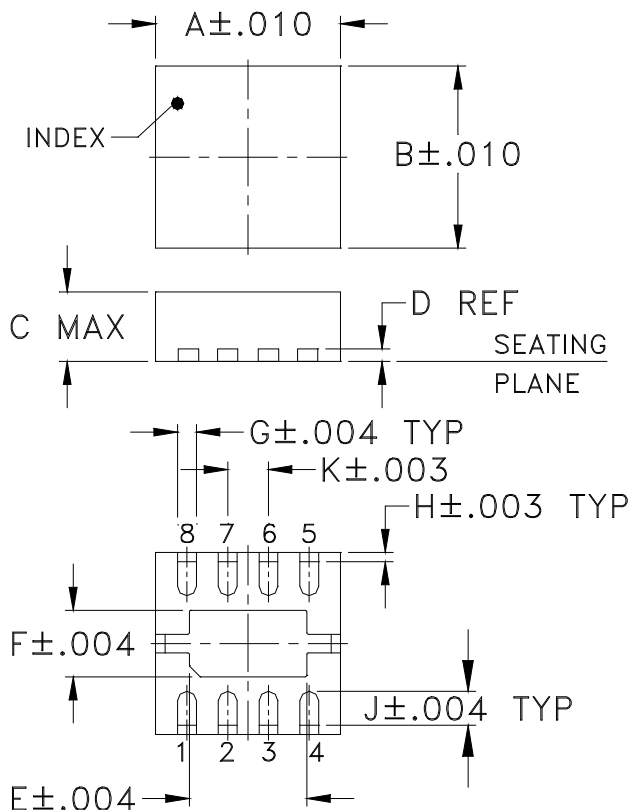

PCB Land Pattern

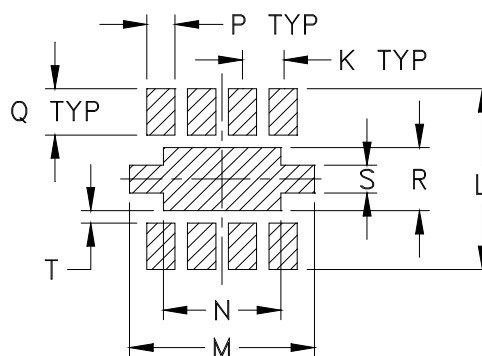

Suggested Layout,
Tolerance to be within $\pm .002$

CASE #	A	B	C	D	E	F	G	H	J	K	L	M	N
DL1721	.118 (3.00)	.118 (3.00)	.045 (1.14)	.008 (0.20)	.075 (1.91)	.043 (1.09)	.012 (0.30)	.006 (0.15)	.022 (0.56)	.026 (0.66)	.117 (2.97)	.118 (3.00)	.075 (1.91)

CASE #	P	Q	R	S	T	WT. GRAM
DL1721	.018 (0.46)	.030 (0.76)	.041 (1.04)	.018 (0.46)	.008 (0.20)	.02

Dimensions are in inches (mm). Tolerances: 3Pl. $\pm .004$, unless otherwise specified.

Notes:

1. Case material: LTCC.
2. Termination finish: Nickel-Palladium-Gold plating.



P.O. Box 350166, Brooklyn, New York 11235-0003 (718) 934-4500 Fax (718) 332-4661 For detailed performance specs & shopping online see Mini-Circuits web site



The Design Engineers Search Engine Provides ACTUAL Data Instantly From MINI-CIRCUITS At: www.minicircuits.com

RF/IF MICROWAVE COMPONENTS

Tape & Reel Packaging TR-F66-1

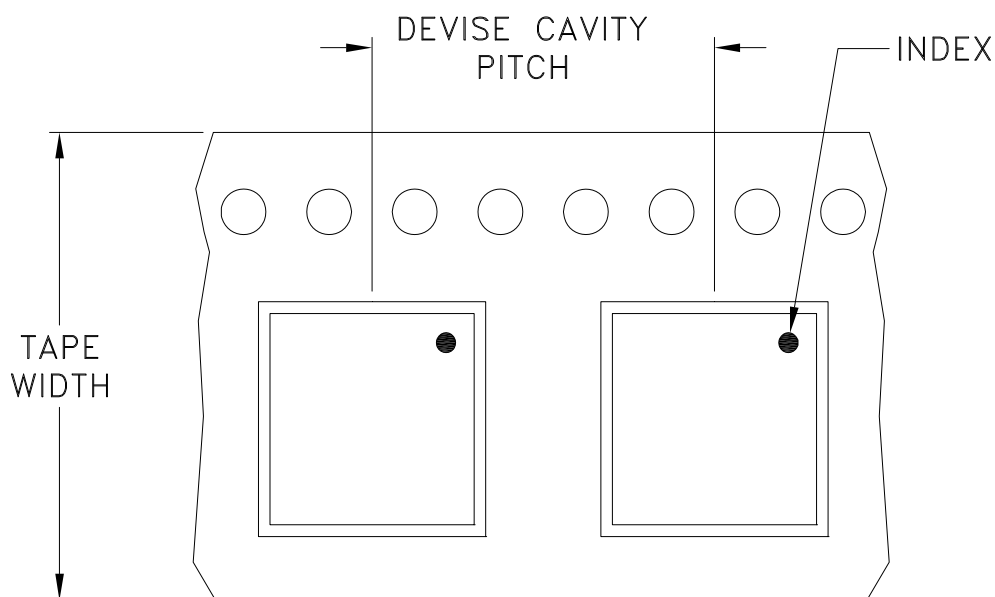

Tape Width, mm	Device Cavity Pitch, mm	Reel Size, inches	Devices per Reel see note	
8	4	7	Small quantity standard	20
				50
				100
				200
				500
		7	Standard	1000, 2000

Note: Please consult individual model data sheet to determine device per reel availability.

Mini-Circuits carrier tape materials provide protection from ESD (Electro-Static Discharge) during handling and transportation. Tapes are static dissipative and comply with industry standards EIA-481/EIA-541.

Go to: www.minicircuits.com/pages/pdfs/tape.pdf



INTERNET <http://www.minicircuits.com>

P.O. Box 350166, Brooklyn, New York 11235-0003 (718) 934-4500 Fax (718) 332-4661

Distribution Centers NORTH AMERICA 800-654-7949 • 417-335-5935 • Fax 417-335-5945 • EUROPE 44-1252-832600 • Fax 44-1252-837010

Mini-Circuits ISO 9001 & ISO 14001 Certified

THIRD ANGLE PROJECTION

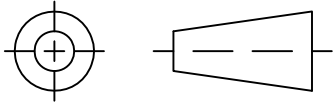

REVISIONS

REV	ECN No.	DESCRIPTION	DATE	DR	AUTH
OR	M169377	NEW RELEASE	08/08/18	GF	DL

**SUGGESTED MOUNTING CONFIGURATION
FOR DL1721 CASE STYLE, "08AM20" PIN CODE**

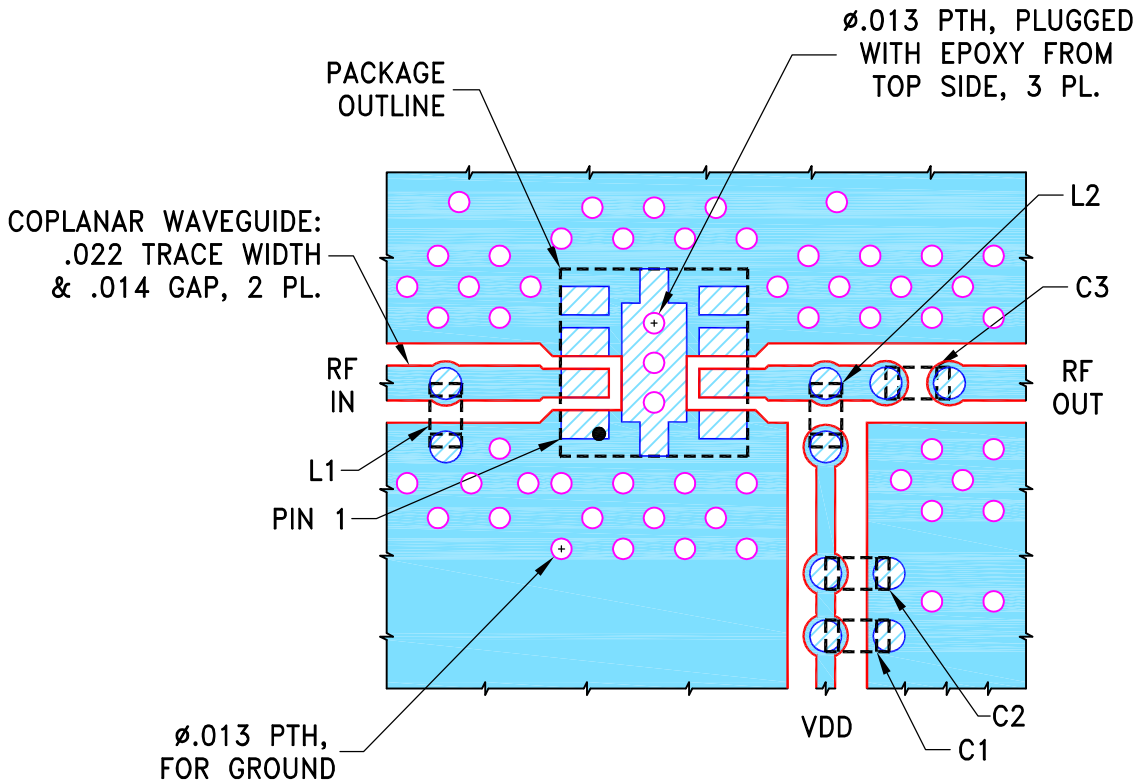

COMPONENT	SIZE
C1-C3, L1-L2	0402

NOTES:

1. TRACE WIDTH & GAP PARAMETERS ARE SHOWN FOR ROGERS R04350B WITH DIELECTRIC THICKNESS .010"±.001". COPPER: 1/2 OZ. EACH SIDE. FOR OTHER MATERIALS TRACE WIDTH & GAP MAY NEED TO BE MODIFIED.
2. CHIP COMPONENT FOOT PRINTS SHOWN FOR REFERENCE. FOR COMPONENT VALUES REFER TO TB-994+.
3. BOTTOM SIDE OF THE PCB IS CONTINUOUS GROUND PLANE.



DENOTES PCB COPPER LAYOUT WITH SMOBC (SOLDER MASK OVER BARE COPPER).



DENOTES COPPER LAND PATTERN FREE OF SOLDER MASK.

UNLESS OTHERWISE SPECIFIED	INITIALS	DATE
DIMENSIONS ARE IN INCHES	DRAWN GF	08/03/18
TOLERANCES ON:	CHECKED IL	08/08/18
2 PL DECIMALS ±	APPROVED DL	08/08/18
3 PL DECIMALS ± .005		
ANGLES ±		
FRACTIONS ±		



Mini-Circuits®

13 Neptune Avenue
Brooklyn NY 11235

PL, 08AM20, DL1721, TB-994+

THIS DOCUMENT AND ITS CONTENTS ARE THE PROPERTY OF MINI-CIRCUITS. EXCEPT FOR USE EXPRESSLY GRANTED, IN WRITING, TO ITS VENDORS, VENDEE AND THE UNITED STATES GOVERNMENT, MINI-CIRCUITS RESERVES ALL PROPRIETARY DESIGN, USE, MANUFACTURING AND REPRODUCTION RIGHTS THERETO. THESE CONTENTS SHALL NOT BE USED, DUPLICATED OR DISCLOSED TO ANY OUTSIDE PARTY, IN WHOLE OR IN PART, WITHOUT WRITTEN PERMISSION OF MINI-CIRCUITS.

SIZE	CODE IDENT	DRAWING NO:	REV:
A	15542	98-PL-606	OR
FILE:	98PL606	SCALE:	8:1
SHEET:	1	OF	1

Evaluation Board and Circuit

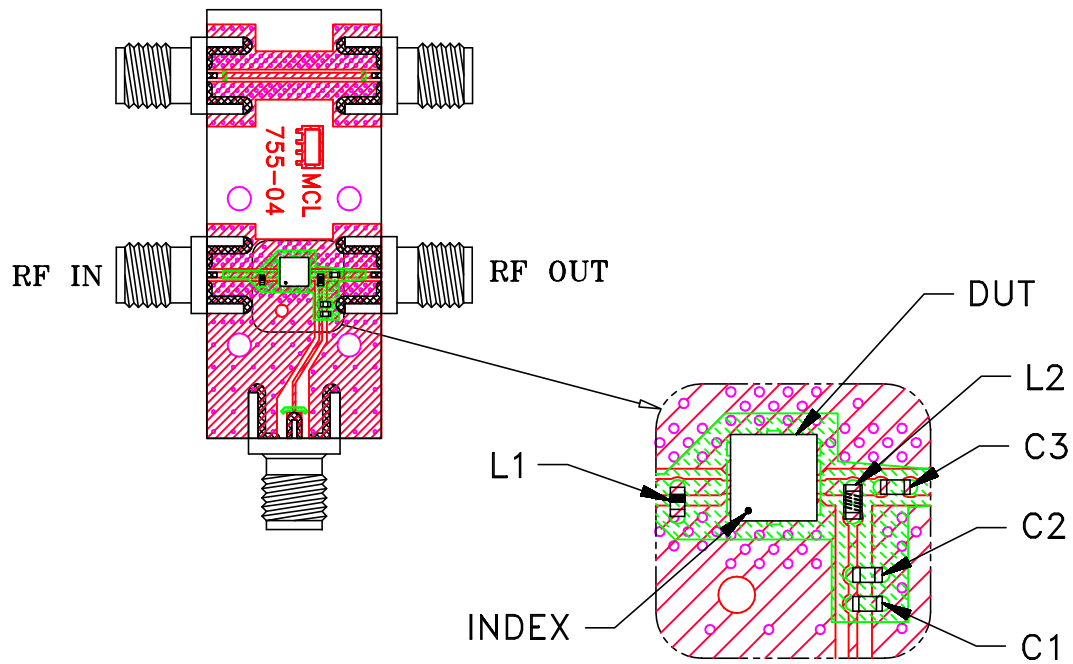

TB-994+

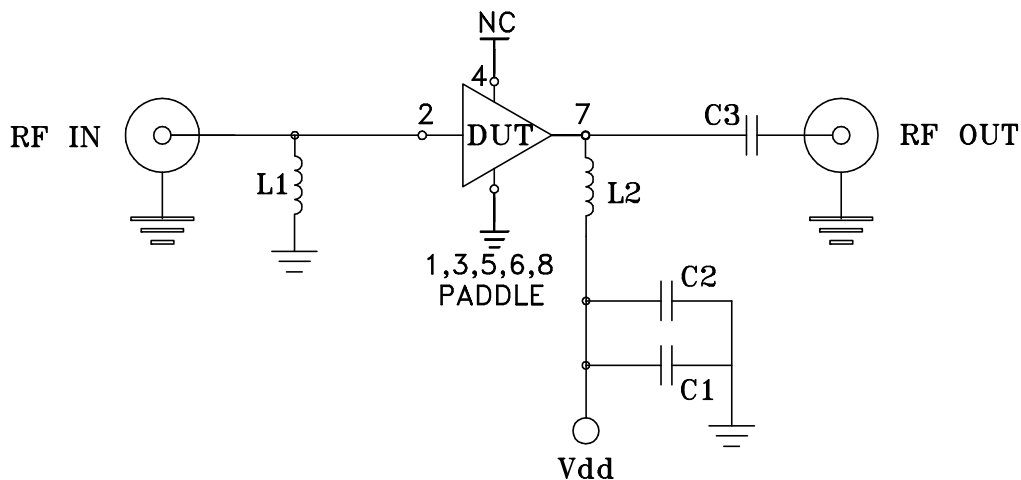

COMPONENT	VALUE	SIZE
DUT	CMA-83LN+	3X3 MM
C1	0.1 μ F	0402
C2	10 pF	
C3	100 pF	
L1	18 nH	
L2	39 nH	

Schematic Diagram

Notes:

1. 50 Ohm SMA Female connectors.
2. PCB Material: R04350 or equivalent,
Dielectric Constant=3.5, Thickness=.010 inch.

 **Mini-Circuits®**



All Mini-Circuits products are manufactured under exacting quality assurance and control standards, and are capable of meeting published specifications after being subjected to any or all of the following physical and environmental test.

Specification	Test/Inspection Condition	Reference/Spec
Operating Temperature	-55° to 105°C	Individual Model Data Sheet
Storage Temperature	-65° to 125° C	Individual Model Data Sheet
Thermal Shock (device level)	-55° to 125°C, 100 cycles	MIL-STD-202, Method 107
Thermal Shock (board level)	-55° to 125°C, 1000 cycles	MIL-STD-202, Method 107
Constant Acceleration	Y1 plane only, 30 Kg	MIL-STD-883, Method 2001, Cond. E
Vibration	10-2000MHz sine, 20g, 3 axis	MIL-STD-202, Method 204, Cond. D
Mechanical Shock	Y1 plane, 5 pulses, .5ms, 1.5 Kg	MIL-STD-202, Method 213, Cond. A
PIND	20G's @130 Hz	MIL-STD-750, Method 2052.2
Resistance to Soldering Heat	3X Reflow, Peak Temperature 260°C, electrical End points	JESD22-B102
Resistance to Solvent	15 pieces, 5 pieces each solvent, marking permanency	MIL-STD-202, Method 215
Moisture Sensitivity Level	Hermetic device, MSL-1 by construction	JESD22-A113, MSL1/260
Hermeticity	Fine Leak, Gross Leak	MIL-STD-202, Method 112, Cond. C&D



All Mini-Circuits products are manufactured under exacting quality assurance and control standards, and are capable of meeting published specifications after being subjected to any or all of the following physical and environmental test.

Specification	Test/Inspection Condition	Reference/Spec
Autoclave	15 psig, 100% RH, 121°C, 96 hours	JEDEC-STD-22-B, Method A102