

# SP6T RF Switch

## JSW6-33DR+

50Ω 5 to 2700 MHz High Power 3W

### The Big Deal

- High Port count in super small size
- Single Positive Supply Voltage, 2.5 – 4.8V
- High Power P0.1dB, 3W typ.
- Low Insertion Loss, 0.6 dB at 1 GHz

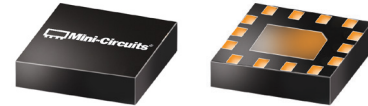

CASE STYLE: MT1817

### Product Overview

JSW6-33DR+ is a high power reflective SP6T RF switch, with reflective short on output ports in the off condition. Made using Silicon-on-Insulator process, it has very high IP3, a built-in CMOS driver and negative voltage generator. Its tiny 2x2mm, 14-lead case enables wideband performance in tight spaces and dense PCB layouts.

### Key Features

Feature	Advantages
Wideband operation 5-2700 MHz	Enables a single component to be used in a vast array of applications from VHF up to 2.7 GHz.
High IIP3: 55 dBm typ.	Results in little or negligible inter-modulation generation, meeting requirements for digital communication signals.
Low Loss, 0.6 dB at 1 GHz High input power, 3W	Low loss and high power capability enable a single switch to be used for a variety of applications, saving inventory.
Built in negative voltage generator	Operates with a single positive supply voltage; no need for DC blocking capacitors, unless external DC is present at the RF ports.
Built-in CMOS driver	No need for external driver, saving PCB space and cost.
Tiny MCLP package 2 x 2mm, 14-lead	Provides low inductance, repeatable transitions, and excellent thermal contact to PCB.



# SP6T RF Switch

50Ω 5-2700 MHz

Reflective RF Switch with internal driver.

Single Supply Voltage, +2.5V to +4.8V, High Power 3W

## Product Features

- High Isolation, 37 dB typ. at 1 GHz
- Low insertion loss, 0.6 dB typ. at 1 GHz
- High IP3, 59 dBm typ. at 1 GHz
- Low current consumption, 40 μA typ.
- High Power, P0.1dB 3W typ.



## JSW6-33DR+

CASE STYLE: MT1817

## Typical Applications

- CATV systems
- SATCOM system
- Automated Test Stations
- Telecom systems

**+RoHS Compliant**  
The +Suffix identifies RoHS Compliance. See our web site for RoHS Compliance methodologies and qualifications

## General Description

JSW6-33DR+ is a high power 3W reflective SPDT switch with integral driver, operates with single positive supply voltage while consuming, 40 μA typical. It has been designed for very wideband operation of 5-2700 MHz. It is packaged in a tiny 14-lead 2mm x 2mm x 0.55mm package and is rated MSL1 and class 1B ESD.

## Simplified Schematic and Pad Description

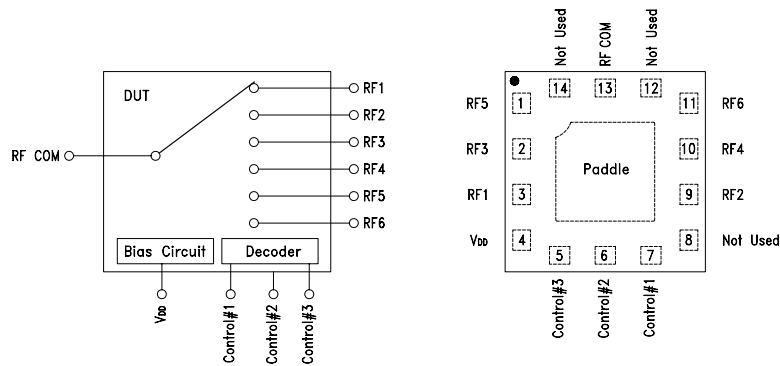

Function	Pad Number	Description
RF COM	13	RF Common/ SUM Port
RF1	3	RF Out #1/In Port #1
RF2	9	RF Out #2/In Port #2
RF3	2	RF Out #3/In Port #3
RF4	10	RF Out #4/In Port #4
RF5	1	RF Out #5/In Port #5
RF6	11	RF Out #6/In Port #6

Function	Pad Number	Description
Control #1	7	Control IN #1
Control #2	6	Control IN #2
Control #3	5	Control IN #3
VDD	4	Supply Voltage
GND	Paddle	Ground
Not Used	8,12,14	No Connection

RF Electrical Specifications<sup>(1)</sup>, 5 - 2700 MHz,  $T_{AMB}=25^{\circ}\text{C}$ ,  $V_{DD}=+2.5$  to 4.8V

Parameter	Condition (MHz)	Min.	Typ.	Max.	Units
Frequency Range		5		2700	MHz
Insertion Loss <sup>(2)</sup>	5 to 1000	—	0.6	0.8	dB
	1000 to 2000	—	0.6	0.8	
	2000 to 2700	—	0.6	0.8	
Isolation between Common Port and RF1 to RF6 Ports <sup>(3)</sup>	5 to 1000	35	37	—	dB
	1000 to 2000	28	30	—	
	2000 to 2700	25	27	—	
Return Loss (ON STATE) RF-COM, RF1 to RF6 Ports	5 to 1000	—	15.5	—	dB
	1000 to 2000	—	14.2	—	
	2000 to 2700	—	14.3	—	
Input IP3	$V_{DD}=2.5$ to 4.8V	5 to 500	—	55	dBm
	$V_{DD}=3.0\text{V}$	1000 to 2700	—	59	
0.1dB Input Compression <sup>(4)</sup>	5 to 2700	—	35	—	dBm

## DC Electrical Specifications

Parameter	Min.	Typ.	Max.	Units
VDD, Supply Voltage	2.5	3.0	4.8	V
Supply Current ( $V_{DD} = 3\text{V}$ )		40		$\mu\text{A}$
Control Voltage Low	0		0.4	V
Control Voltage High	1.35	1.8	2.7	V
Control Current		0.5	1.0	$\mu\text{A}$
Shutdown Current at $V_{DD} = 3\text{V}$		5		$\mu\text{A}$

## Notes:

- As measured in Mini-Circuit's test board TB-724+ (see Characterization Test Circuit, Fig.1).
- Insertion loss values are de-embedded from test board loss.
- Isolations for other port combinations, see Tables 1 & 2
- Do not exceed RF input power as shown in Absolute Maximum Rating table.

## Switching Specifications

Parameter	Min.	Typ.	Max.	Units
Rise/Fall Time (10 to 90% or 90 to 10% RF)	—	0.42 (Rise Time) 0.84 (Fall Time)	—	$\mu\text{Sec}$
Switching Time, 50% CTRL to 90/10% RF	—	1.9 (ON Time) 1.4 (OFF Time)	—	$\mu\text{Sec}$
Video Feedthrough, (control 0 to 1.65V, freq.=10 KHz)	—	3.0	—	mV <sub>p-p</sub>

Table 1. Isolation Matrix (RF-COM to RF1 to RF6 Ports)

RF Com to Port	Frequency (GHz)	Isolation, Typ. (dB)					
		"On" Port					
		RF1	RF2	RF3	RF4	RF5	RF6
RF1	0.01-1.0	-	49	37	48	53	49
RF1	1.0-2.0	-	43	30	42	38	43
RF1	2.0-2.7	-	40	28	38	34	39
RF2	0.01-1.0	48	-	48	38	48	50
RF2	1.0-2.0	43	-	42	30	42	38
RF2	2.0-2.7	39	-	38	28	39	33
RF3	0.01-1.0	39	44	-	44	38	45
RF3	1.0-2.0	32	38	-	38	30	39
RF3	2.0-2.7	29	35	-	35	28	36
RF4	0.01-1.0	44	39	44	-	44	37
RF4	1.0-2.0	38	31	38	-	39	30
RF4	2.0-2.7	35	28	35	-	36	27
RF5	0.01-1.0	44	39	44	40	-	40
RF5	1.0-2.0	33	34	31	34	-	34
RF5	2.0-2.7	28	31	27	31	-	31
RF6	0.01-1.0	39	41	39	43	40	-
RF6	1.0-2.0	33	32	34	31	34	-
RF6	2.0-2.7	31	28	31	27	31	-

Table 2. Isolation Matrix (Between Output Ports)

	Frequency (GHz)	Isolation, Typ. (dB)					
		"On" Port					
		RF1	RF2	RF3	RF4	RF5	RF6
From Port to Port							
RF1	0.01-1.0	-	54	29	57	37	55
RF1	1.0-2.0	-	45	24	47	32	46
RF1	2.0-2.7	-	41	22	42	28	42
RF2	0.01-1.0	54	-	57	29	55	37
RF2	1.0-2.0	44	-	46	24	45	32
RF2	2.0-2.7	40	-	41	22	41	29
RF3	0.01-1.0	30	58	-	59	29	62
RF3	1.0-2.0	25	46	-	46	24	46
RF3	2.0-2.7	22	43	-	43	22	43
RF4	0.01-1.0	58	30	58	-	62	30
RF4	1.0-2.0	45	25	46	-	46	24
RF4	2.0-2.7	42	22	42	-	42	22
RF5	0.01-1.0	44	58	32	45	-	48
RF5	1.0-2.0	37	45	26	38	-	40
RF5	2.0-2.7	32	42	23	37	-	37
RF6	0.01-1.0	45	44	46	32	48	-
RF6	1.0-2.0	38	37	38	26	39	-
RF6	2.0-2.7	36	32	36	23	37	-

**Absolute Maximum Ratings<sup>(5)</sup>**

Parameter	Ratings
Operating Temperature	-40°C to +85°C
Storage Temperature	-55°C to 150°C
V <sub>DD</sub> , Supply Voltage	5.0V
Voltage Control	-0.5V Min. 3.0 Max.
RF input power <sup>6</sup>	5 Watt

5. Operation of this device above any of these conditions may cause permanent damage.  
 6. Derate linearly to 2.5W at 85°C.

**Truth Table<sup>(7)</sup>** (State of control voltage selects the desired switch state)

State of Control Voltages			RF Common to					
Control #1	Control #2	Control #3	RF1	RF2	RF3	RF4	RF5	RF6
L	L	L	ON	—	—	—	—	—
L	L	H	—	ON	—	—	—	—
L	H	L	—	—	ON	—	—	—
L	H	H	—	—	—	ON	—	—
H	L	L	—	—	—	—	ON	—
H	L	H	—	—	—	—	—	ON
H	H	H	Shutdown					

7. Any control state not defined above, places the switch in an undefined state, but will not damage the switch.

**Characterization Test Circuit**

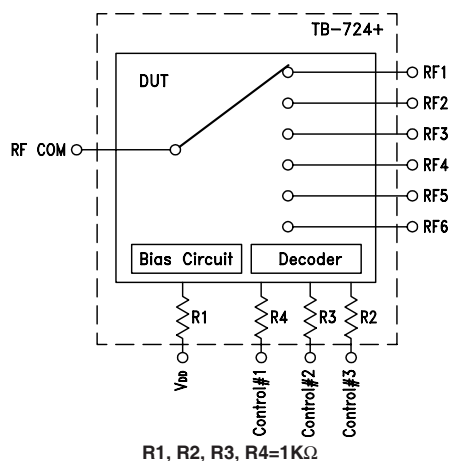

Figure 1: Block Diagram Of Test Circuit Used For Characterization. (DUT soldered on Mini-Circuits' TB-724+)

**Test Equipment:**

- For Insertion loss, Isolation, Return loss:**  
Agilent's N5230A Network Analyzer , E3631A power supply.
- For Switching Time and Video Feed through**  
Agilent's HP81110A pulse generator, 54833A Oscilloscope, E3631A power supply.  
Agilent's N9020A Spectrum Analyzer , E8257D Generator, E3631A power supply
- For Compression:**  
R&S Network Analyzer ZVA24, E3631A power supply.

**Conditions:**

- V<sub>DD</sub>= +2.5, +3.0 and +4.8V, Control= 0 and 1.35V.
- For Insertion loss, isolation and return loss:** Pin=0 dBm
- For Input IP3:** Pin=+10dBm/tone at V<sub>DD</sub>=3V
- For Switching time:** RF frequency: DC at 200mV, Control Frequency: 10 KHz and 0 and +8V.

Product Marking

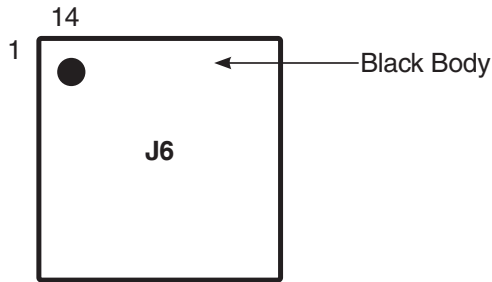

Recommended Application Circuit

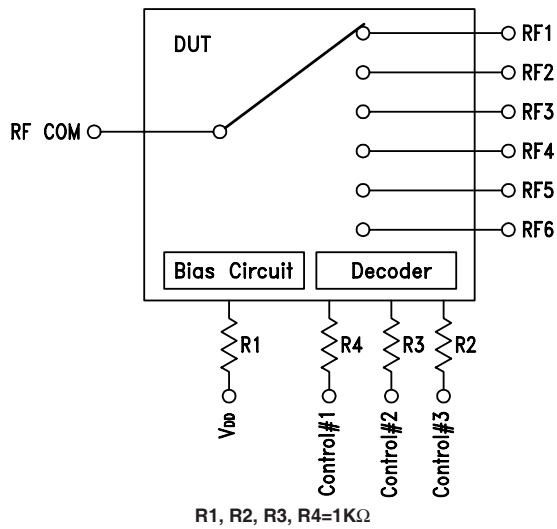

Fig. 2: Evaluation board includes case, connectors and components soldered to PCB.

Additional Detailed Technical Information	
<i>additional information is available on our dash board. To access this information <a href="#">click here</a></i>	
<b>Performance Data</b>	Data Table
	Swept Graphs
<b>Case Style</b>	MT1817 <i>Plastic package; Lead finish: Matte Tin</i>
<b>Tape &amp; Reel</b>	F108
<b>Standard quantities available on reel</b>	<i>7" reels with 20, 50, 100, 200, 500, 1K or 3K devices</i>
<b>Suggested Layout for PCB Design</b>	PL-416
<b>Evaluation Board</b>	TB-724+
<b>Environmental Ratings</b>	ENV75

### ESD Rating

Human Body Model (HBM): Class 1B (500 to < 1000V) in accordance with JESD22-A114

Machine Model (MM): Class A (Pass 100V) in accordance with JESD22-A115

### MSL Rating

Moisture Sensitivity: MSL1 in accordance with IPC/JEDEC J-STD-020D

### MSL Test Flow Chart

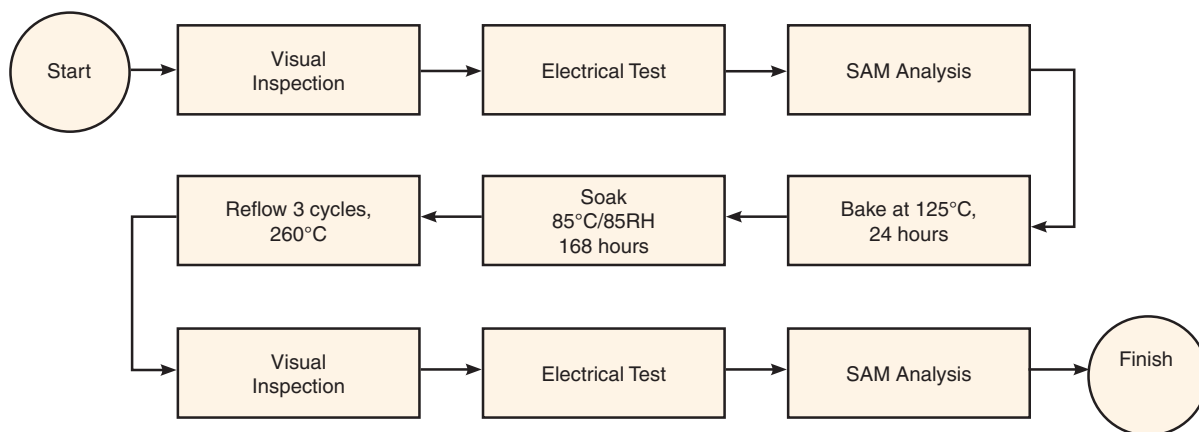

### Additional Notes

- A. Performance and quality attributes and conditions not expressly stated in this specification document are intended to be excluded and do not form a part of this specification document.
- B. Electrical specifications and performance data contained in this specification document are based on Mini-Circuit's applicable established test performance criteria and measurement instructions.
- C. The parts covered by this specification document are subject to Mini-Circuits standard limited warranty and terms and conditions (collectively, "Standard Terms"); Purchasers of this part are entitled to the rights and benefits contained therein. For a full statement of the Standard Terms and the exclusive rights and remedies thereunder, please visit Mini-Circuits' website at [www.minicircuits.com/MCLStore/terms.jsp](http://www.minicircuits.com/MCLStore/terms.jsp)

Typical Performance Data

RF FREQ (MHz)	INSERTION LOSS (dB)						RF FREQ (MHz)	ISOLATION (dB)											
	VDD=+2.5V		VDD=+3V		VDD=+4.8V			VDD=+2.5V		VDD=+3V		VDD=+4.8V		VDD=+2.5V		VDD=+3V		VDD=+4.8V	
	RF COM-RF1	RF COM-RF6	RF COM-RF1	RF COM-RF6	RF COM-RF1	RF COM-RF6		RF COM-RF1 (RF2 ON)	RF COM-RF6 (RF5 ON)	RF COM-RF1 (RF2 ON)	RF COM-RF6 (RF5 ON)	RF COM-RF1 (RF2 ON)	RF COM-RF6 (RF5 ON)	RF3-RF4 (RF3 ON)	RF3-RF5 (RF3 ON)	RF3-RF4 (RF3 ON)	RF3-RF5 (RF3 ON)	RF3-RF4 (RF3 ON)	RF3-RF5 (RF3 ON)
10.0	0.40	0.38	0.41	0.38	0.41	0.38	10.0	57.61	59.40	56.08	55.44	62.30	57.26	61.77	53.57	61.12	56.06	62.79	55.22
20.0	0.42	0.42	0.42	0.42	0.42	0.41	20.0	80.10	70.81	100.60	82.20	74.87	71.69	78.23	65.23	88.19	67.59	77.79	65.63
30.0	0.42	0.42	0.42	0.42	0.42	0.41	30.0	82.27	72.64	77.80	72.52	82.69	72.94	78.42	63.89	86.79	63.44	79.48	64.63
40.0	0.42	0.42	0.42	0.42	0.42	0.42	40.0	78.08	70.57	76.16	69.19	82.00	70.31	81.28	61.96	89.47	60.90	85.59	61.55
50.0	0.42	0.42	0.43	0.42	0.42	0.42	50.0	63.00	62.72	60.23	59.84	62.71	62.96	61.07	59.62	62.06	54.84	62.11	68.78
60.0	0.42	0.42	0.42	0.42	0.42	0.41	60.0	74.59	62.98	69.68	67.15	68.23	63.41	68.32	57.14	69.03	55.41	68.21	59.58
70.0	0.42	0.42	0.42	0.43	0.42	0.42	70.0	74.76	64.99	74.42	64.56	73.78	64.58	83.18	56.48	83.82	56.18	86.02	56.68
80.0	0.42	0.43	0.43	0.43	0.42	0.42	80.0	72.32	63.92	71.36	63.15	72.65	63.66	80.20	55.36	81.19	55.40	84.57	55.20
90.0	0.43	0.43	0.43	0.43	0.43	0.42	90.0	70.14	62.70	70.11	61.62	71.48	62.62	84.68	54.23	80.53	54.41	82.01	54.12
100.0	0.43	0.43	0.43	0.43	0.43	0.42	100.0	69.12	61.37	69.72	61.37	70.08	61.38	86.27	53.24	79.86	53.35	79.59	53.22
200.0	0.43	0.43	0.43	0.43	0.43	0.42	200.0	64.53	55.15	63.94	54.99	64.22	55.15	78.32	47.18	76.44	47.20	75.06	47.14
300.0	0.43	0.43	0.43	0.43	0.43	0.43	300.0	60.31	51.47	60.56	51.54	60.07	51.47	72.27	43.61	71.71	43.60	71.74	43.66
400.0	0.43	0.44	0.44	0.44	0.44	0.43	400.0	57.95	49.07	57.78	48.98	57.92	49.01	71.77	41.14	70.17	41.15	70.67	41.12
500.0	0.43	0.44	0.43	0.44	0.43	0.43	500.0	55.98	46.92	55.73	46.84	55.78	46.91	67.83	39.07	68.43	39.08	67.48	39.09
600.0	0.44	0.45	0.44	0.45	0.44	0.44	600.0	54.10	45.20	54.13	45.24	54.20	45.20	66.08	37.49	66.08	37.48	66.32	37.49
700.0	0.44	0.45	0.44	0.45	0.44	0.45	700.0	52.92	43.70	52.92	43.69	53.01	43.69	64.96	36.05	65.11	36.04	64.98	36.03
800.0	0.43	0.45	0.43	0.45	0.43	0.44	800.0	51.83	42.44	51.73	42.47	51.65	42.45	61.68	34.78	61.50	34.79	62.04	34.79
900.0	0.43	0.45	0.44	0.45	0.44	0.45	900.0	50.63	41.49	50.75	41.50	50.72	41.54	59.20	33.79	59.23	33.78	59.11	33.79
1000.0	0.43	0.45	0.43	0.45	0.43	0.45	1000.0	49.80	40.29	49.75	40.30	49.67	40.29	58.38	32.80	58.32	32.81	58.49	32.81
1100.0	0.42	0.44	0.42	0.44	0.42	0.44	1100.0	49.19	39.39	49.14	39.39	49.09	39.40	57.82	31.84	57.97	31.84	58.05	31.84
1200.0	0.42	0.44	0.43	0.45	0.43	0.44	1200.0	48.18	38.66	48.24	38.67	48.21	38.67	55.59	31.05	55.61	31.05	55.69	31.05
1300.0	0.42	0.44	0.42	0.44	0.43	0.44	1300.0	47.68	37.85	47.69	37.86	47.58	37.85	53.39	30.44	53.42	30.44	53.42	30.43
1400.0	0.41	0.43	0.41	0.43	0.41	0.43	1400.0	46.87	37.34	46.92	37.34	46.91	37.36	52.54	29.74	52.52	29.74	52.68	29.74
1500.0	0.41	0.43	0.41	0.43	0.41	0.43	1500.0	46.07	36.59	46.07	36.60	46.09	36.60	51.24	29.22	51.34	29.22	51.40	29.22
1600.0	0.42	0.43	0.42	0.43	0.42	0.43	1600.0	45.93	36.08	45.91	36.07	45.89	36.09	51.03	28.59	51.03	28.58	51.08	28.60
1700.0	0.40	0.42	0.40	0.43	0.41	0.42	1700.0	44.93	35.75	44.93	35.74	45.11	35.73	49.69	28.13	49.71	28.13	49.71	28.14
1800.0	0.40	0.42	0.40	0.42	0.40	0.41	1800.0	44.96	35.26	44.98	35.24	44.99	35.26	48.08	27.86	48.05	27.86	47.99	27.86
1900.0	0.40	0.43	0.40	0.43	0.41	0.42	1900.0	44.23	34.93	44.22	34.94	44.17	34.94	47.84	27.30	47.80	27.30	47.74	27.30
2000.0	0.40	0.42	0.40	0.42	0.40	0.42	2000.0	43.18	34.47	43.24	34.47	43.30	34.46	46.49	27.01	46.47	27.01	46.39	27.02
2100.0	0.37	0.40	0.37	0.40	0.38	0.40	2100.0	43.16	33.99	43.14	33.99	43.17	33.99	46.15	26.42	46.15	26.42	46.16	26.43
2200.0	0.38	0.41	0.38	0.41	0.38	0.40	2200.0	42.15	33.85	42.23	33.86	42.27	33.85	46.28	26.06	46.27	26.06	46.32	26.08
2300.0	0.37	0.40	0.37	0.40	0.38	0.39	2300.0	41.71	33.17	41.73	33.16	41.52	33.17	43.89	25.97	43.89	25.97	43.91	25.99
2400.0	0.35	0.37	0.35	0.37	0.35	0.37	2400.0	41.31	32.75	41.33	32.72	41.46	32.71	44.19	25.19	44.18	25.19	44.33	25.20
2500.0	0.35	0.36	0.35	0.37	0.36	0.36	2500.0	40.93	32.38	40.93	32.39	40.82	32.39	44.19	24.95	44.24	24.95	44.28	24.95
2600.0	0.34	0.36	0.35	0.36	0.35	0.36	2600.0	40.14	31.68	40.15	31.68	40.16	31.66	42.56	24.55	42.57	24.55	42.64	24.53
2700.0	0.34	0.35	0.34	0.35	0.35	0.35	2700.0	39.99	31.38	40.00	31.39	39.85	31.41	43.56	23.96	43.55	23.96	43.46	23.97
2800.0	0.36	0.38	0.36	0.38	0.36	0.38	2800.0	39.34	31.02	39.32	31.03	39.22	31.04	42.79	23.92	42.77	23.93	42.72	23.93



P.O. Box 350166, Brooklyn, New York 11235-0003 (718) 934-4500 • Fax (718) 332-4661 For detailed performance specs & shopping online see Mini-Circuits web site



The Design Engineers Search Engine Provides ACTUAL Data Instantly From MINI-CIRCUITS At: [www.minicircuits.com](http://www.minicircuits.com)

IF/RF MICROWAVE COMPONENTS

REV. OR  
JSW6-33DR+  
3/18/2014  
Page 1 of 9



Typical Performance Data

RF FREQ (MHz)	VSWR (:1) (ON STATE)												RF FREQ (MHz)	VSWR (:1) (OFF STATE)					
	VDD=+2.5V				VDD=+3V				VDD=+4.8V					VDD=+2.5V		VDD=+3V		VDD=+4.8V	
	RF COM		RF1	RF6	RF COM		RF1	RF6	RF COM		RF1	RF6		RF1	RF6	RF1	RF6	RF1	RF6
	(RF1 ON)	(RF6 ON)	(RF1 ON)	(RF6 ON)	(RF1 ON)	(RF6 ON)	(RF1 ON)	(RF6 ON)	(RF1 ON)	(RF6 ON)	(RF1 ON)	(RF6 ON)		(RF2 ON)	(RF1 ON)	(RF2 ON)	(RF1 ON)	(RF1 ON)	(RF1 ON)
10.0	1.07	1.06	1.07	1.06	1.06	1.07	1.07	1.06	1.07	1.06	1.07	1.06	3.37	3.40	3.37	3.40	3.36	3.38	
20.0	1.06	1.06	1.06	1.06	1.06	1.06	1.06	1.06	1.06	1.06	1.06	1.06	3.35	3.39	3.35	3.38	3.34	3.37	
30.0	1.06	1.06	1.06	1.06	1.06	1.06	1.06	1.06	1.06	1.06	1.06	1.06	3.35	3.40	3.35	3.40	3.34	3.38	
40.0	1.06	1.06	1.06	1.06	1.06	1.06	1.06	1.06	1.06	1.06	1.06	1.06	3.35	3.39	3.35	3.39	3.34	3.38	
50.0	1.07	1.07	1.06	1.06	1.06	1.07	1.06	1.06	1.07	1.06	1.06	1.06	3.35	3.38	3.35	3.38	3.34	3.36	
60.0	1.07	1.07	1.06	1.06	1.07	1.07	1.06	1.06	1.07	1.07	1.06	1.06	3.35	3.37	3.35	3.36	3.34	3.35	
70.0	1.07	1.07	1.06	1.06	1.07	1.07	1.06	1.06	1.07	1.07	1.06	1.06	3.34	3.37	3.34	3.36	3.33	3.35	
80.0	1.07	1.07	1.06	1.06	1.07	1.07	1.06	1.06	1.07	1.07	1.06	1.06	3.34	3.38	3.34	3.38	3.33	3.36	
90.0	1.07	1.07	1.06	1.06	1.07	1.07	1.06	1.06	1.07	1.07	1.06	1.06	3.34	3.39	3.34	3.39	3.33	3.37	
100.0	1.07	1.07	1.06	1.06	1.07	1.07	1.06	1.06	1.07	1.07	1.06	1.06	3.34	3.39	3.34	3.39	3.33	3.37	
200.0	1.07	1.07	1.07	1.07	1.07	1.07	1.07	1.07	1.07	1.07	1.07	1.07	3.33	3.35	3.33	3.34	3.31	3.33	
300.0	1.08	1.09	1.08	1.10	1.08	1.09	1.08	1.10	1.08	1.09	1.08	1.10	3.31	3.34	3.31	3.34	3.30	3.32	
400.0	1.10	1.11	1.07	1.11	1.10	1.11	1.07	1.11	1.10	1.11	1.07	1.11	3.31	3.30	3.31	3.29	3.30	3.28	
500.0	1.09	1.11	1.08	1.13	1.09	1.11	1.08	1.13	1.10	1.11	1.08	1.13	3.30	3.26	3.30	3.25	3.29	3.24	
600.0	1.12	1.14	1.09	1.16	1.12	1.14	1.10	1.16	1.12	1.14	1.10	1.16	3.27	3.21	3.27	3.21	3.26	3.20	
700.0	1.13	1.13	1.08	1.15	1.13	1.13	1.08	1.15	1.13	1.13	1.08	1.15	3.26	3.16	3.26	3.15	3.25	3.14	
800.0	1.10	1.11	1.08	1.15	1.10	1.12	1.09	1.15	1.11	1.12	1.09	1.15	3.25	3.15	3.25	3.15	3.23	3.13	
900.0	1.12	1.14	1.09	1.18	1.12	1.14	1.09	1.17	1.13	1.14	1.09	1.18	3.21	3.08	3.22	3.08	3.21	3.06	
1000.0	1.12	1.11	1.06	1.14	1.12	1.12	1.06	1.14	1.12	1.11	1.06	1.14	3.22	3.06	3.22	3.06	3.20	3.05	
1100.0	1.09	1.08	1.06	1.15	1.09	1.08	1.06	1.15	1.09	1.08	1.06	1.15	3.22	3.02	3.21	3.02	3.20	3.01	
1200.0	1.12	1.11	1.07	1.15	1.12	1.12	1.07	1.15	1.12	1.12	1.07	1.15	3.20	3.03	3.21	3.03	3.20	3.02	
1300.0	1.13	1.09	1.03	1.10	1.13	1.09	1.03	1.10	1.13	1.09	1.03	1.10	3.20	3.01	3.20	3.01	3.18	3.00	
1400.0	1.08	1.03	1.04	1.12	1.08	1.03	1.04	1.12	1.08	1.03	1.04	1.12	3.20	3.02	3.20	3.01	3.19	3.00	
1500.0	1.10	1.06	1.03	1.12	1.10	1.06	1.03	1.12	1.10	1.06	1.03	1.12	3.22	3.02	3.22	3.02	3.21	3.00	
1600.0	1.15	1.08	1.04	1.07	1.15	1.08	1.03	1.07	1.15	1.08	1.03	1.07	3.22	3.02	3.22	3.01	3.20	3.00	
1700.0	1.12	1.08	1.08	1.13	1.12	1.08	1.08	1.13	1.13	1.08	1.09	1.14	3.23	3.08	3.24	3.09	3.23	3.07	
1800.0	1.10	1.05	1.05	1.12	1.10	1.05	1.05	1.12	1.10	1.05	1.05	1.12	3.29	3.15	3.29	3.14	3.27	3.13	
1900.0	1.17	1.14	1.09	1.12	1.17	1.14	1.09	1.12	1.17	1.14	1.09	1.12	3.29	3.22	3.30	3.22	3.29	3.20	
2000.0	1.18	1.17	1.15	1.19	1.18	1.17	1.15	1.19	1.18	1.17	1.15	1.19	3.34	3.26	3.34	3.26	3.33	3.25	
2100.0	1.10	1.11	1.10	1.16	1.10	1.10	1.10	1.15	1.09	1.11	1.10	1.16	3.42	3.40	3.41	3.39	3.39	3.37	
2200.0	1.16	1.17	1.10	1.15	1.16	1.17	1.11	1.15	1.16	1.17	1.11	1.15	3.40	3.50	3.42	3.50	3.41	3.48	
2300.0	1.16	1.18	1.15	1.19	1.16	1.18	1.16	1.19	1.16	1.18	1.16	1.19	3.47	3.57	3.45	3.56	3.43	3.56	
2400.0	1.05	1.07	1.12	1.13	1.06	1.07	1.12	1.13	1.05	1.07	1.11	1.13	3.49	3.62	3.50	3.62	3.48	3.60	
2500.0	1.06	1.10	1.07	1.07	1.06	1.10	1.07	1.07	1.06	1.10	1.07	1.07	3.47	3.73	3.48	3.72	3.45	3.70	
2600.0	1.07	1.08	1.12	1.09	1.07	1.08	1.12	1.09	1.07	1.08	1.12	1.09	3.52	3.80	3.51	3.81	3.49	3.78	
2700.0	1.08	1.07	1.15	1.10	1.08	1.07	1.14	1.10	1.08	1.07	1.14	1.10	3.54	3.79	3.56	3.77	3.54	3.76	
2800.0	1.11	1.16	1.11	1.10	1.11	1.16	1.11	1.11	1.11	1.16	1.12	1.10	3.54	3.79	3.52	3.79	3.50	3.77	



P.O. Box 350166, Brooklyn, New York 11235-0003 (718) 934-4500 • Fax (718) 332-4661 For detailed performance specs & shopping online see Mini-Circuits web site  
 The Design Engineers Search Engine Provides ACTUAL Data Instantly From MINI-CIRCUITS At: www.minicircuits.com

REV. OR  
 JSW6-33DR+  
 3/18/2014  
 Page 2 of 9

## Typical Performance Data

RF FREQ (MHz)	INPUT IP3 (dBm)		RF FREQ (MHz)	COMPRESSION (dB) @ FIXED POWER FOR PIN=34.5dBm	
	VDD=+3V			VDD=+3V	
	RF COM-RF1	RF COM-RF6		RF COM-RF1	RF COM-RF6
10.1	55.53	56.04	10.0	-0.03	0.02
250.1	58.87	58.43	20.0	0.08	0.08
500.1	54.96	54.72	30.0	-0.05	0.03
1000.1	66.99	66.16	40.0	-0.02	0.00
1500.1	61.74	61.53	50.0	0.03	0.04
2000.1	61.54	63.51	60.0	0.01	0.02
2500.1	59.45	60.55	70.0	0.01	0.01
3000.1	61.24	61.12	80.0	0.00	0.03
			90.0	0.01	0.01
			100.0	0.00	0.01
			200.0	0.01	0.00
			300.0	0.00	0.01
			400.0	0.01	0.00
			500.0	0.00	0.00
			600.0	0.00	0.00
			700.0	-0.01	0.00
			800.0	-0.01	-0.01
			900.0	-0.02	0.00
			1000.0	-0.01	-0.02
			1100.0	-0.01	-0.01
			1200.0	-0.01	-0.03
			1300.0	-0.01	-0.02
			1400.0	-0.01	-0.02
			1500.0	-0.02	-0.02
			1600.0	-0.01	-0.02
			1700.0	-0.02	-0.02
			1800.0	-0.02	-0.02
			1900.0	0.00	-0.01
			2000.0	-0.01	-0.01
			2100.0	-0.01	-0.01
			2200.0	0.00	-0.02
			2300.0	0.00	-0.02
			2400.0	0.00	-0.01
			2500.0	0.00	-0.01
			2600.0	0.01	-0.01
			2700.0	0.01	0.01
			2800.0	0.01	0.01

Typical Performance Data

RF FREQ (MHz)	INSERTION LOSS (dB) @ VDD=+3V OVER TEMPERATURE						RF FREQ (MHz)	ISOLATION (dB) @ VDD=+3V OVER TEMPERATURE											
	RF COM-RF1			RF COM-RF6				RF COM-RF1 (RF2 ON)			RF COM-RF6 (RF5 ON)			RF3-RF4 (RF3 ON)			RF3-RF5 (RF3 ON)		
	-45°C	+25°C	+90°C	-45°C	+25°C	+90°C		-45°C	+25°C	+90°C	-45°C	+25°C	+90°C	-45°C	+25°C	+90°C	-45°C	+25°C	+90°C
10.0	0.31	0.41	0.48	0.30	0.38	0.46	10.0	61.53	56.08	56.20	55.71	55.44	62.48	59.55	61.12	56.02	58.43	56.06	59.04
20.0	0.33	0.42	0.50	0.34	0.42	0.50	20.0	80.56	100.60	83.18	75.77	82.20	76.93	85.00	88.19	84.61	66.63	67.59	66.61
30.0	0.33	0.42	0.50	0.34	0.42	0.50	30.0	95.14	77.80	78.13	72.29	72.52	71.56	80.60	86.79	83.74	64.57	63.44	63.05
40.0	0.33	0.42	0.50	0.35	0.42	0.50	40.0	80.15	76.16	74.29	69.52	69.19	68.94	83.01	89.47	81.96	60.76	60.90	60.28
50.0	0.34	0.43	0.50	0.35	0.42	0.50	50.0	61.71	60.23	59.63	58.06	59.84	61.86	62.10	62.06	61.03	56.32	54.84	56.21
60.0	0.34	0.42	0.50	0.35	0.42	0.49	60.0	73.60	69.68	65.74	62.27	67.15	72.97	72.26	69.03	67.93	58.21	55.41	58.05
70.0	0.34	0.42	0.50	0.35	0.43	0.50	70.0	78.65	74.42	71.47	64.87	64.56	64.88	78.83	83.82	90.55	56.77	56.18	56.11
80.0	0.35	0.43	0.50	0.36	0.43	0.50	80.0	73.84	71.36	69.73	63.42	63.15	62.82	76.72	81.19	91.36	55.52	55.40	54.82
90.0	0.35	0.43	0.50	0.36	0.43	0.50	90.0	72.17	70.11	69.55	62.99	61.62	61.53	74.63	80.53	83.68	54.44	54.41	53.98
100.0	0.35	0.43	0.50	0.36	0.43	0.50	100.0	71.17	69.72	69.19	61.96	61.37	60.92	76.25	79.86	87.30	53.75	53.35	53.08
200.0	0.35	0.43	0.51	0.36	0.43	0.51	200.0	65.94	63.94	62.68	55.11	54.99	54.95	70.42	76.44	94.73	47.47	47.20	46.95
300.0	0.36	0.43	0.53	0.35	0.43	0.53	300.0	62.27	60.56	59.31	51.44	51.54	51.51	68.23	71.71	75.94	43.96	43.60	43.47
400.0	0.37	0.44	0.54	0.35	0.44	0.54	400.0	59.07	57.78	56.66	49.13	48.98	48.78	65.20	70.17	75.78	41.34	41.15	40.86
500.0	0.38	0.43	0.54	0.34	0.44	0.55	500.0	57.00	55.73	54.57	46.97	46.84	46.73	63.38	68.43	72.59	39.28	39.08	38.92
600.0	0.40	0.44	0.56	0.34	0.45	0.56	600.0	55.37	54.13	53.01	45.27	45.24	45.15	61.76	66.08	69.77	37.66	37.48	37.23
700.0	0.40	0.44	0.56	0.33	0.45	0.57	700.0	53.90	52.92	51.93	43.69	43.69	43.66	60.46	65.11	69.68	36.16	36.04	35.85
800.0	0.39	0.43	0.56	0.32	0.45	0.57	800.0	52.68	51.73	50.69	42.47	42.47	42.46	57.87	61.50	65.80	34.88	34.79	34.66
900.0	0.41	0.44	0.57	0.32	0.45	0.59	900.0	51.71	50.75	49.72	41.55	41.50	41.48	56.21	59.23	62.16	33.90	33.78	33.62
1000.0	0.39	0.43	0.58	0.31	0.45	0.59	1000.0	50.60	49.75	48.67	40.24	40.30	40.30	55.71	58.32	60.39	32.90	32.81	32.65
1100.0	0.37	0.42	0.57	0.30	0.44	0.59	1100.0	50.12	49.14	48.19	39.32	39.39	39.46	54.89	57.97	60.23	31.87	31.84	31.75
1200.0	0.37	0.43	0.58	0.30	0.45	0.59	1200.0	49.15	48.24	47.26	38.58	38.67	38.74	52.90	55.61	58.19	31.07	31.05	31.00
1300.0	0.37	0.42	0.59	0.29	0.44	0.60	1300.0	48.57	47.69	46.56	37.72	37.86	37.95	51.35	53.42	55.25	30.43	30.44	30.37
1400.0	0.34	0.41	0.58	0.27	0.43	0.59	1400.0	47.89	46.92	45.92	37.25	37.34	37.44	50.66	52.52	54.10	29.73	29.74	29.72
1500.0	0.33	0.41	0.58	0.27	0.43	0.60	1500.0	46.92	46.07	45.24	36.45	36.60	36.72	49.56	51.34	52.69	29.21	29.22	29.20
1600.0	0.34	0.42	0.60	0.26	0.43	0.60	1600.0	46.85	45.91	44.83	35.95	36.07	36.16	49.37	51.03	52.06	28.55	28.58	28.58
1700.0	0.33	0.40	0.59	0.26	0.43	0.60	1700.0	45.97	44.93	44.21	35.65	35.74	35.84	48.03	49.71	51.10	28.09	28.13	28.16
1800.0	0.32	0.40	0.58	0.24	0.42	0.60	1800.0	45.98	44.98	43.98	35.13	35.24	35.33	46.63	48.05	49.04	27.87	27.86	27.79
1900.0	0.35	0.40	0.60	0.25	0.43	0.61	1900.0	45.20	44.22	43.26	34.86	34.94	34.99	46.50	47.80	48.81	27.26	27.30	27.26
2000.0	0.34	0.40	0.59	0.24	0.42	0.60	2000.0	43.96	43.24	42.37	34.38	34.47	34.52	45.32	46.47	47.20	27.02	27.01	26.95
2100.0	0.30	0.37	0.57	0.22	0.40	0.59	2100.0	44.17	43.14	42.27	33.92	33.99	34.03	45.26	46.15	46.71	26.41	26.42	26.38
2200.0	0.32	0.38	0.59	0.22	0.41	0.60	2200.0	43.16	42.23	41.24	33.83	33.86	33.83	45.02	46.27	47.38	26.03	26.06	26.01
2300.0	0.30	0.37	0.58	0.21	0.40	0.59	2300.0	42.28	41.73	40.70	33.12	33.16	33.17	43.12	43.89	44.60	26.03	25.97	25.85
2400.0	0.24	0.35	0.57	0.18	0.37	0.57	2400.0	42.31	41.33	40.54	32.69	32.72	32.73	43.63	44.18	44.69	25.22	25.19	25.15
2500.0	0.23	0.35	0.57	0.17	0.37	0.58	2500.0	41.65	40.93	40.10	32.34	32.39	32.40	43.30	44.24	44.86	24.95	24.95	24.90
2600.0	0.22	0.35	0.57	0.16	0.36	0.57	2600.0	40.77	40.15	39.53	31.59	31.68	31.72	41.92	42.57	42.98	24.49	24.55	24.48
2700.0	0.19	0.34	0.58	0.15	0.35	0.58	2700.0	40.57	40.00	39.29	31.32	31.39	31.45	42.70	43.55	43.95	23.96	23.96	23.96
2800.0	0.20	0.36	0.61	0.16	0.38	0.61	2800.0	39.88	39.32	38.70	30.88	31.03	31.13	41.75	42.77	43.51	23.89	23.93	23.90



P.O. Box 350166, Brooklyn, New York 11235-0003 (718) 934-4500 • Fax (718) 332-4661 For detailed performance specs & shopping online see Mini-Circuits web site



The Design Engineers Search Engine Provides ACTUAL Data Instantly From MINI-CIRCUITS At: [www.minicircuits.com](http://www.minicircuits.com)

IF/RF MICROWAVE COMPONENTS

REV. OR  
JSW6-33DR+  
3/18/2014  
Page 4 of 9

Typical Performance Data

RF FREQ (MHz)	VSWR (:1) @ VDD=+3V OVER TEMPERATURE (ON STATE)												RF FREQ (MHz)	VSWR (:1) @ VDD=+3V OVER TEMPERATURE (OFF STATE)					
	RF COM						RF1			RF6				RF1			RF6		
	(RF1 ON)			(RF6 ON)			(RF1 ON)			(RF6 ON)				(RF2 ON)			(RF1 ON)		
	-45°C	+25°C	+90°C	-45°C	+25°C	+90°C	-45°C	+25°C	+90°C	-45°C	+25°C	+90°C		-45°C	+25°C	+90°C	-45°C	+25°C	+90°C
10.0	1.06	1.06	1.08	1.05	1.07	1.07	1.06	1.07	1.08	1.05	1.06	1.07	10.0	4.31	3.37	2.67	4.37	3.40	2.69
20.0	1.05	1.06	1.08	1.05	1.06	1.08	1.05	1.06	1.08	1.05	1.06	1.08	20.0	4.27	3.35	2.66	4.34	3.38	2.68
30.0	1.05	1.06	1.08	1.05	1.06	1.08	1.05	1.06	1.08	1.05	1.06	1.08	30.0	4.27	3.35	2.66	4.35	3.40	2.68
40.0	1.05	1.06	1.08	1.05	1.06	1.08	1.05	1.06	1.08	1.05	1.06	1.08	40.0	4.27	3.35	2.66	4.35	3.39	2.68
50.0	1.05	1.06	1.09	1.05	1.07	1.08	1.05	1.06	1.08	1.05	1.06	1.08	50.0	4.26	3.35	2.66	4.33	3.38	2.68
60.0	1.05	1.07	1.09	1.06	1.07	1.09	1.05	1.06	1.08	1.05	1.06	1.08	60.0	4.26	3.35	2.66	4.32	3.36	2.68
70.0	1.05	1.07	1.09	1.06	1.07	1.08	1.05	1.06	1.08	1.05	1.06	1.08	70.0	4.25	3.34	2.66	4.32	3.36	2.68
80.0	1.05	1.07	1.08	1.05	1.07	1.08	1.05	1.06	1.08	1.05	1.06	1.08	80.0	4.25	3.34	2.66	4.32	3.38	2.68
90.0	1.05	1.07	1.09	1.05	1.07	1.09	1.05	1.06	1.08	1.05	1.06	1.08	90.0	4.24	3.34	2.66	4.33	3.39	2.68
100.0	1.05	1.07	1.09	1.05	1.07	1.09	1.04	1.06	1.08	1.05	1.06	1.08	100.0	4.24	3.34	2.67	4.33	3.39	2.69
200.0	1.05	1.07	1.08	1.05	1.07	1.09	1.05	1.07	1.09	1.05	1.07	1.09	200.0	4.22	3.33	2.66	4.28	3.34	2.67
300.0	1.06	1.08	1.10	1.08	1.09	1.11	1.06	1.08	1.10	1.08	1.10	1.12	300.0	4.23	3.31	2.63	4.29	3.34	2.64
400.0	1.08	1.10	1.12	1.10	1.11	1.13	1.05	1.07	1.09	1.09	1.11	1.12	400.0	4.23	3.31	2.63	4.24	3.29	2.61
500.0	1.08	1.09	1.11	1.09	1.11	1.12	1.07	1.08	1.10	1.11	1.13	1.15	500.0	4.22	3.30	2.61	4.20	3.25	2.57
600.0	1.10	1.12	1.14	1.12	1.14	1.15	1.08	1.10	1.12	1.14	1.16	1.18	600.0	4.20	3.27	2.58	4.15	3.21	2.53
700.0	1.11	1.13	1.14	1.12	1.13	1.14	1.06	1.08	1.09	1.13	1.15	1.16	700.0	4.21	3.26	2.56	4.10	3.15	2.48
800.0	1.09	1.10	1.12	1.11	1.12	1.12	1.07	1.09	1.10	1.14	1.15	1.17	800.0	4.19	3.25	2.56	4.08	3.15	2.47
900.0	1.10	1.12	1.14	1.13	1.14	1.15	1.08	1.09	1.11	1.16	1.17	1.19	900.0	4.16	3.22	2.53	4.01	3.08	2.43
1000.0	1.10	1.12	1.14	1.11	1.12	1.13	1.05	1.06	1.07	1.13	1.14	1.15	1000.0	4.19	3.22	2.51	4.00	3.06	2.39
1100.0	1.08	1.09	1.10	1.09	1.08	1.07	1.06	1.06	1.07	1.14	1.15	1.16	1100.0	4.18	3.21	2.53	3.95	3.02	2.37
1200.0	1.11	1.12	1.13	1.12	1.12	1.11	1.07	1.07	1.07	1.14	1.15	1.16	1200.0	4.17	3.21	2.53	3.97	3.03	2.39
1300.0	1.12	1.13	1.15	1.09	1.09	1.11	1.04	1.03	1.03	1.10	1.10	1.10	1300.0	4.17	3.20	2.51	3.91	3.01	2.38
1400.0	1.06	1.08	1.11	1.04	1.03	1.04	1.02	1.04	1.07	1.10	1.12	1.13	1400.0	4.17	3.20	2.52	3.92	3.01	2.39
1500.0	1.09	1.10	1.11	1.07	1.06	1.06	1.03	1.03	1.04	1.10	1.12	1.13	1500.0	4.19	3.22	2.56	3.93	3.02	2.39
1600.0	1.14	1.15	1.17	1.06	1.08	1.09	1.05	1.03	1.03	1.04	1.07	1.09	1600.0	4.19	3.22	2.55	3.93	3.01	2.39
1700.0	1.10	1.12	1.14	1.06	1.08	1.10	1.07	1.08	1.11	1.12	1.13	1.16	1700.0	4.22	3.24	2.56	3.98	3.09	2.43
1800.0	1.08	1.10	1.10	1.04	1.05	1.06	1.04	1.05	1.06	1.09	1.12	1.14	1800.0	4.24	3.29	2.62	4.07	3.14	2.51
1900.0	1.17	1.17	1.18	1.14	1.14	1.14	1.10	1.09	1.08	1.11	1.12	1.12	1900.0	4.27	3.30	2.62	4.18	3.22	2.57
2000.0	1.17	1.18	1.17	1.17	1.17	1.16	1.15	1.15	1.14	1.18	1.19	1.19	2000.0	4.34	3.34	2.65	4.25	3.26	2.60
2100.0	1.09	1.10	1.09	1.11	1.10	1.09	1.10	1.10	1.09	1.15	1.15	1.16	2100.0	4.40	3.41	2.71	4.40	3.39	2.69
2200.0	1.16	1.16	1.15	1.17	1.17	1.16	1.12	1.11	1.08	1.16	1.15	1.13	2200.0	4.42	3.42	2.70	4.47	3.50	2.77
2300.0	1.17	1.16	1.14	1.20	1.18	1.16	1.17	1.16	1.13	1.21	1.19	1.17	2300.0	4.51	3.45	2.74	4.69	3.56	2.81
2400.0	1.07	1.06	1.03	1.08	1.07	1.05	1.12	1.12	1.11	1.13	1.13	1.12	2400.0	4.54	3.50	2.76	4.74	3.62	2.86
2500.0	1.07	1.06	1.07	1.09	1.10	1.11	1.08	1.07	1.06	1.09	1.07	1.05	2500.0	4.53	3.48	2.74	4.87	3.72	2.92
2600.0	1.09	1.07	1.05	1.09	1.08	1.08	1.13	1.12	1.11	1.11	1.09	1.07	2600.0	4.62	3.51	2.76	5.02	3.81	2.96
2700.0	1.09	1.08	1.08	1.06	1.07	1.08	1.13	1.14	1.15	1.08	1.10	1.11	2700.0	4.67	3.56	2.76	5.06	3.77	2.95
2800.0	1.09	1.11	1.13	1.13	1.16	1.18	1.09	1.11	1.13	1.08	1.11	1.12	2800.0	4.63	3.52	2.73	5.02	3.79	2.93



P.O. Box 350166, Brooklyn, New York 11235-0003 (718) 934-4500 • Fax (718) 332-4661 For detailed performance specs & shopping online see Mini-Circuits web site

The Design Engineers Search Engine Provides ACTUAL Data Instantly From MINI-CIRCUITS At: www.minicircuits.com

IF/RF MICROWAVE COMPONENTS

REV. OR  
JSW6-33DR+  
3/18/2014  
Page 5 of 9

Typical Performance Data

RF FREQ (MHz)	INSERTION LOSS (dB) @ VDD=+2.5V OVER TEMPERATURE						RF FREQ (MHz)	ISOLATION (dB) @ VDD=+2.5V OVER TEMPERATURE											
	RF COM-RF1			RF COM-RF6				RF COM-RF1 (RF2 ON)			RF COM-RF6 (RF5 ON)			RF3-RF4 (RF3 ON)			RF3-RF5 (RF3 ON)		
	-45°C	+25°C	+90°C	-45°C	+25°C	+90°C		-45°C	+25°C	+90°C	-45°C	+25°C	+90°C	-45°C	+25°C	+90°C	-45°C	+25°C	+90°C
10.0	0.33	0.40	0.49	0.29	0.38	0.46	10.0	56.13	57.61	54.61	57.00	59.40	57.37	55.79	61.77	60.26	57.91	53.57	55.92
20.0	0.34	0.42	0.50	0.33	0.42	0.50	20.0	81.02	80.10	80.84	77.45	70.81	73.76	74.42	78.23	89.40	67.65	65.23	67.56
30.0	0.34	0.42	0.50	0.33	0.42	0.50	30.0	81.80	82.27	82.78	70.96	72.64	73.60	78.75	78.42	90.20	63.67	63.89	63.43
40.0	0.35	0.42	0.50	0.34	0.42	0.50	40.0	80.27	78.08	76.71	69.23	70.57	70.14	82.02	81.28	94.78	60.89	61.96	60.55
50.0	0.35	0.42	0.50	0.34	0.42	0.50	50.0	60.16	63.00	59.86	59.32	62.72	62.79	61.48	61.07	61.47	54.73	59.62	54.32
60.0	0.35	0.42	0.50	0.34	0.42	0.50	60.0	67.18	74.59	65.32	66.06	62.98	63.53	66.79	68.32	68.32	56.63	57.14	55.96
70.0	0.35	0.42	0.50	0.34	0.42	0.50	70.0	73.57	74.76	71.60	64.67	64.99	63.80	77.92	83.18	91.17	56.65	56.48	55.99
80.0	0.35	0.42	0.50	0.35	0.43	0.50	80.0	74.20	72.32	70.60	63.20	63.92	63.28	80.47	80.20	87.40	55.63	55.36	55.02
90.0	0.36	0.43	0.51	0.35	0.43	0.50	90.0	72.64	70.14	70.42	62.26	62.70	62.41	78.17	84.68	94.18	54.72	54.23	54.13
100.0	0.36	0.43	0.51	0.35	0.43	0.51	100.0	73.03	69.12	70.20	61.64	61.37	61.02	74.92	86.27	93.53	53.74	53.24	53.11
200.0	0.35	0.43	0.51	0.35	0.43	0.51	200.0	65.17	64.53	62.73	55.14	55.15	54.93	70.59	78.32	98.54	47.47	47.18	46.97
300.0	0.35	0.43	0.53	0.34	0.43	0.53	300.0	61.61	60.31	59.08	51.57	51.47	51.29	66.61	72.27	77.24	43.87	43.61	43.37
400.0	0.34	0.43	0.54	0.34	0.44	0.54	400.0	59.00	57.95	56.56	49.17	49.07	48.88	65.73	71.77	76.11	41.35	41.14	40.89
500.0	0.33	0.43	0.54	0.33	0.44	0.55	500.0	56.80	55.98	54.53	46.87	46.92	46.78	62.91	67.83	72.46	39.26	39.07	38.86
600.0	0.33	0.44	0.56	0.33	0.45	0.57	600.0	55.21	54.10	53.07	45.26	45.20	45.10	62.16	66.08	70.13	37.66	37.49	37.24
700.0	0.32	0.44	0.57	0.32	0.45	0.57	700.0	54.02	52.92	51.93	43.69	43.70	43.67	60.44	64.96	70.34	36.18	36.05	35.84
800.0	0.31	0.43	0.56	0.32	0.45	0.57	800.0	52.68	51.83	50.62	42.47	42.44	42.41	57.81	61.68	65.98	34.88	34.78	34.65
900.0	0.30	0.43	0.58	0.31	0.45	0.59	900.0	51.63	50.63	49.64	41.52	41.49	41.46	56.27	59.20	62.21	33.90	33.79	33.63
1000.0	0.29	0.43	0.58	0.30	0.45	0.59	1000.0	50.66	49.80	48.65	40.23	40.29	40.30	55.64	58.38	60.55	32.90	32.80	32.67
1100.0	0.28	0.42	0.57	0.29	0.44	0.59	1100.0	50.19	49.19	48.09	39.29	39.39	39.44	54.88	57.82	60.21	31.87	31.84	31.75
1200.0	0.28	0.42	0.58	0.29	0.44	0.59	1200.0	49.19	48.18	47.21	38.60	38.66	38.70	52.86	55.59	58.15	31.06	31.05	30.99
1300.0	0.27	0.42	0.59	0.28	0.44	0.60	1300.0	48.45	47.68	46.57	37.73	37.85	37.94	51.34	53.39	55.20	30.45	30.44	30.37
1400.0	0.25	0.41	0.58	0.26	0.43	0.59	1400.0	47.90	46.87	45.90	37.25	37.34	37.43	50.54	52.54	54.07	29.72	29.74	29.72
1500.0	0.25	0.41	0.58	0.26	0.43	0.60	1500.0	46.94	46.07	45.22	36.46	36.59	36.70	49.67	51.24	52.61	29.21	29.22	29.20
1600.0	0.25	0.42	0.60	0.25	0.43	0.60	1600.0	46.83	45.93	44.80	35.92	36.08	36.18	49.41	51.03	52.06	28.56	28.59	28.57
1700.0	0.23	0.40	0.59	0.24	0.42	0.60	1700.0	45.93	44.93	44.19	35.65	35.75	35.82	48.01	49.69	51.18	28.08	28.13	28.16
1800.0	0.22	0.40	0.58	0.23	0.42	0.60	1800.0	45.97	44.96	43.96	35.13	35.26	35.33	46.67	48.08	49.02	27.86	27.86	27.79
1900.0	0.22	0.40	0.60	0.24	0.43	0.61	1900.0	45.22	44.23	43.30	34.87	34.93	34.99	46.53	47.84	48.77	27.27	27.30	27.27
2000.0	0.21	0.40	0.59	0.23	0.42	0.60	2000.0	44.03	43.18	42.37	34.38	34.47	34.52	45.35	46.49	47.21	27.02	27.01	26.96
2100.0	0.19	0.37	0.57	0.21	0.40	0.59	2100.0	44.19	43.16	42.25	33.92	33.99	34.01	45.28	46.15	46.70	26.41	26.42	26.38
2200.0	0.19	0.38	0.59	0.21	0.41	0.60	2200.0	43.15	42.15	41.22	33.83	33.85	33.83	45.00	46.28	47.32	26.04	26.06	26.02
2300.0	0.18	0.37	0.58	0.20	0.40	0.59	2300.0	42.29	41.71	40.71	33.12	33.17	33.18	43.01	43.89	44.57	26.04	25.97	25.85
2400.0	0.16	0.35	0.56	0.17	0.37	0.57	2400.0	42.28	41.31	40.53	32.66	32.75	32.72	43.72	44.19	44.63	25.19	25.19	25.14
2500.0	0.15	0.35	0.57	0.16	0.36	0.57	2500.0	41.67	40.93	40.10	32.35	32.38	32.40	43.30	44.19	44.88	24.97	24.95	24.91
2600.0	0.14	0.34	0.57	0.15	0.36	0.57	2600.0	40.74	40.14	39.50	31.59	31.68	31.73	41.89	42.56	43.00	24.51	24.55	24.49
2700.0	0.13	0.34	0.58	0.14	0.35	0.57	2700.0	40.59	39.99	39.29	31.32	31.38	31.45	42.76	43.56	43.95	23.94	23.96	23.96
2800.0	0.14	0.36	0.61	0.16	0.38	0.61	2800.0	39.88	39.34	38.69	30.89	31.02	31.12	41.71	42.79	43.51	23.91	23.92	23.91



P.O. Box 350166, Brooklyn, New York 11235-0003 (718) 934-4500 • Fax (718) 332-4661 For detailed performance specs & shopping online see Mini-Circuits web site



The Design Engineers Search Engine Provides ACTUAL Data Instantly From MINI-CIRCUITS At: www.minicircuits.com

IF/RF MICROWAVE COMPONENTS

REV. OR  
JSW6-33DR+  
3/18/2014  
Page 6 of 9

Typical Performance Data

RF FREQ (MHz)	VSWR (:1) @ VDD=+2.5V OVER TEMPERATURE (ON STATE)												RF FREQ (MHz)	VSWR (:1) @ VDD=+2.5V OVER TEMPERATURE (OFF STATE)					
	RF COM						RF1			RF6				RF1			RF6		
	(RF1 ON)			(RF6 ON)			(RF1 ON)			(RF6 ON)				(RF2 ON)			(RF1 ON)		
	-45°C	+25°C	+90°C	-45°C	+25°C	+90°C	-45°C	+25°C	+90°C	-45°C	+25°C	+90°C		-45°C	+25°C	+90°C	-45°C	+25°C	+90°C
10.0	1.06	1.07	1.08	1.05	1.06	1.07	1.06	1.07	1.08	1.05	1.06	1.07	10.0	4.30	3.37	2.67	4.37	3.40	2.68
20.0	1.05	1.06	1.08	1.05	1.06	1.08	1.05	1.06	1.08	1.05	1.06	1.08	20.0	4.27	3.35	2.66	4.34	3.39	2.67
30.0	1.05	1.06	1.08	1.05	1.06	1.08	1.05	1.06	1.08	1.05	1.06	1.08	30.0	4.27	3.35	2.66	4.35	3.40	2.68
40.0	1.05	1.06	1.08	1.05	1.06	1.08	1.05	1.06	1.08	1.05	1.06	1.08	40.0	4.27	3.35	2.66	4.34	3.39	2.68
50.0	1.05	1.07	1.09	1.05	1.07	1.09	1.05	1.06	1.08	1.05	1.06	1.08	50.0	4.26	3.35	2.66	4.33	3.38	2.67
60.0	1.05	1.07	1.09	1.06	1.07	1.09	1.05	1.06	1.08	1.05	1.06	1.08	60.0	4.25	3.35	2.66	4.31	3.37	2.67
70.0	1.05	1.07	1.09	1.05	1.07	1.09	1.05	1.06	1.08	1.05	1.06	1.08	70.0	4.25	3.34	2.66	4.31	3.37	2.67
80.0	1.05	1.07	1.08	1.05	1.07	1.08	1.05	1.06	1.08	1.05	1.06	1.08	80.0	4.25	3.34	2.66	4.32	3.38	2.67
90.0	1.05	1.07	1.09	1.05	1.07	1.09	1.05	1.06	1.08	1.05	1.06	1.08	90.0	4.24	3.34	2.66	4.32	3.39	2.68
100.0	1.05	1.07	1.09	1.05	1.07	1.09	1.04	1.06	1.08	1.05	1.06	1.08	100.0	4.24	3.34	2.67	4.32	3.39	2.68
200.0	1.05	1.07	1.08	1.05	1.07	1.09	1.05	1.07	1.09	1.05	1.07	1.09	200.0	4.22	3.33	2.66	4.28	3.35	2.66
300.0	1.06	1.08	1.10	1.08	1.09	1.11	1.06	1.08	1.10	1.08	1.10	1.12	300.0	4.23	3.31	2.63	4.29	3.34	2.63
400.0	1.08	1.10	1.12	1.10	1.11	1.13	1.05	1.07	1.09	1.09	1.11	1.12	400.0	4.23	3.31	2.62	4.23	3.30	2.60
500.0	1.08	1.09	1.11	1.09	1.11	1.12	1.07	1.08	1.10	1.11	1.13	1.15	500.0	4.21	3.30	2.62	4.19	3.26	2.57
600.0	1.10	1.12	1.14	1.12	1.14	1.15	1.08	1.09	1.12	1.14	1.16	1.18	600.0	4.20	3.27	2.58	4.15	3.21	2.52
700.0	1.11	1.13	1.14	1.12	1.13	1.15	1.06	1.08	1.09	1.13	1.15	1.16	700.0	4.21	3.26	2.55	4.09	3.16	2.47
800.0	1.09	1.10	1.12	1.11	1.11	1.12	1.07	1.08	1.09	1.14	1.15	1.17	800.0	4.19	3.25	2.56	4.07	3.15	2.47
900.0	1.10	1.12	1.14	1.13	1.14	1.15	1.08	1.09	1.11	1.16	1.18	1.19	900.0	4.16	3.21	2.53	4.01	3.08	2.42
1000.0	1.10	1.12	1.14	1.11	1.11	1.13	1.05	1.06	1.07	1.13	1.14	1.15	1000.0	4.18	3.22	2.50	4.00	3.06	2.39
1100.0	1.08	1.09	1.10	1.09	1.08	1.07	1.06	1.06	1.07	1.14	1.15	1.16	1100.0	4.17	3.22	2.53	3.95	3.02	2.37
1200.0	1.11	1.12	1.13	1.12	1.11	1.11	1.07	1.07	1.08	1.14	1.15	1.16	1200.0	4.17	3.20	2.53	3.96	3.03	2.39
1300.0	1.12	1.13	1.15	1.09	1.09	1.11	1.04	1.03	1.03	1.09	1.10	1.10	1300.0	4.16	3.20	2.50	3.91	3.01	2.38
1400.0	1.06	1.08	1.11	1.04	1.03	1.04	1.02	1.04	1.06	1.10	1.12	1.13	1400.0	4.16	3.20	2.53	3.92	3.02	2.38
1500.0	1.09	1.10	1.11	1.07	1.06	1.06	1.02	1.03	1.04	1.10	1.12	1.13	1500.0	4.18	3.22	2.56	3.92	3.02	2.39
1600.0	1.14	1.15	1.17	1.06	1.08	1.09	1.05	1.04	1.04	1.04	1.07	1.09	1600.0	4.19	3.22	2.54	3.93	3.02	2.38
1700.0	1.10	1.12	1.14	1.06	1.08	1.10	1.07	1.08	1.10	1.11	1.13	1.16	1700.0	4.21	3.23	2.57	3.98	3.08	2.44
1800.0	1.08	1.10	1.10	1.04	1.05	1.06	1.04	1.05	1.06	1.09	1.12	1.14	1800.0	4.24	3.29	2.61	4.07	3.15	2.50
1900.0	1.17	1.17	1.18	1.13	1.14	1.14	1.10	1.09	1.08	1.11	1.12	1.12	1900.0	4.28	3.29	2.62	4.18	3.22	2.57
2000.0	1.17	1.18	1.17	1.17	1.17	1.16	1.15	1.15	1.14	1.18	1.19	1.19	2000.0	4.33	3.34	2.67	4.24	3.26	2.60
2100.0	1.09	1.10	1.09	1.11	1.11	1.10	1.10	1.10	1.09	1.15	1.16	1.16	2100.0	4.39	3.42	2.69	4.40	3.40	2.68
2200.0	1.16	1.16	1.15	1.17	1.17	1.16	1.12	1.10	1.09	1.16	1.15	1.13	2200.0	4.43	3.40	2.70	4.47	3.50	2.76
2300.0	1.17	1.16	1.14	1.20	1.18	1.16	1.17	1.15	1.13	1.21	1.19	1.17	2300.0	4.48	3.47	2.75	4.68	3.57	2.80
2400.0	1.07	1.05	1.03	1.08	1.07	1.05	1.12	1.12	1.11	1.13	1.13	1.12	2400.0	4.54	3.49	2.75	4.75	3.62	2.86
2500.0	1.07	1.06	1.07	1.10	1.10	1.11	1.08	1.07	1.06	1.08	1.07	1.06	2500.0	4.53	3.47	2.74	4.86	3.73	2.92
2600.0	1.09	1.07	1.05	1.09	1.08	1.08	1.13	1.12	1.10	1.11	1.09	1.07	2600.0	4.60	3.52	2.77	5.03	3.80	2.96
2700.0	1.09	1.08	1.08	1.06	1.07	1.08	1.13	1.15	1.16	1.08	1.10	1.11	2700.0	4.68	3.54	2.76	5.06	3.79	2.93
2800.0	1.09	1.11	1.13	1.13	1.16	1.18	1.10	1.11	1.13	1.08	1.10	1.11	2800.0	4.63	3.54	2.72	4.99	3.79	2.94



P.O. Box 350166, Brooklyn, New York 11235-0003 (718) 934-4500 • Fax (718) 332-4661 For detailed performance specs & shopping online see Mini-Circuits web site



The Design Engineers Search Engine Provides ACTUAL Data Instantly From MINI-CIRCUITS At: [www.minicircuits.com](http://www.minicircuits.com)

IF/RF MICROWAVE COMPONENTS

REV. OR  
JSW6-33DR+  
3/18/2014  
Page 7 of 9

Typical Performance Data

RF FREQ (MHz)	INSERTION LOSS (dB) @ VDD=+4.8V OVER TEMPERATURE						RF FREQ (MHz)	ISOLATION (dB) @ VDD=+4.8V OVER TEMPERATURE											
	RF COM-RF1			RF COM-RF6				RF COM-RF1 (RF2 ON)			RF COM-RF6 (RF5 ON)			RF3-RF4 (RF3 ON)			RF3-RF5 (RF3 ON)		
	-45°C	+25°C	+90°C	-45°C	+25°C	+90°C		-45°C	+25°C	+90°C	-45°C	+25°C	+90°C	-45°C	+25°C	+90°C	-45°C	+25°C	+90°C
10.0	0.33	0.41	0.49	0.30	0.38	0.46	10.0	59.38	62.30	56.45	55.50	57.26	55.91	65.22	62.79	55.60	59.24	55.22	66.30
20.0	0.34	0.42	0.50	0.34	0.41	0.50	20.0	76.70	74.87	79.21	79.71	71.69	77.11	79.14	77.79	77.94	66.72	65.63	67.80
30.0	0.34	0.42	0.50	0.34	0.41	0.50	30.0	83.82	82.69	85.31	74.55	72.94	70.55	77.29	79.48	83.52	64.18	64.63	63.06
40.0	0.35	0.42	0.50	0.34	0.42	0.50	40.0	81.43	82.00	76.66	69.03	70.31	68.20	83.53	85.59	84.58	61.76	61.55	60.43
50.0	0.35	0.42	0.50	0.35	0.42	0.50	50.0	59.90	62.71	62.82	58.96	62.96	57.84	61.79	62.11	61.45	61.08	68.78	55.83
60.0	0.35	0.42	0.50	0.34	0.41	0.49	60.0	67.21	68.23	69.41	65.38	63.41	61.60	67.17	68.21	68.84	60.50	59.58	57.88
70.0	0.35	0.42	0.50	0.35	0.42	0.50	70.0	74.25	73.78	72.46	64.83	64.58	64.04	78.23	86.02	88.72	56.88	56.68	56.03
80.0	0.35	0.42	0.50	0.35	0.42	0.50	80.0	73.67	72.65	72.26	63.20	63.66	62.97	79.60	84.57	99.04	55.42	55.20	54.83
90.0	0.36	0.43	0.50	0.35	0.42	0.50	90.0	73.08	71.48	69.75	62.16	62.62	62.34	77.25	82.01	84.58	54.42	54.12	53.90
100.0	0.36	0.43	0.51	0.35	0.42	0.50	100.0	72.77	70.08	68.22	61.63	61.38	61.47	75.64	79.59	86.78	53.65	53.22	53.17
200.0	0.35	0.43	0.51	0.35	0.42	0.51	200.0	65.29	64.22	63.06	55.16	55.15	54.76	70.31	75.06	88.88	47.37	47.14	46.98
300.0	0.35	0.43	0.53	0.35	0.43	0.52	300.0	61.70	60.07	59.25	51.59	51.47	51.18	66.34	71.74	76.82	43.92	43.66	43.41
400.0	0.34	0.44	0.54	0.34	0.43	0.54	400.0	58.84	57.92	56.70	49.10	49.01	48.82	65.85	70.67	74.93	41.32	41.12	40.84
500.0	0.33	0.43	0.54	0.33	0.43	0.54	500.0	56.78	55.78	54.71	46.90	46.91	46.76	62.82	67.48	72.83	39.28	39.09	38.88
600.0	0.33	0.44	0.56	0.33	0.44	0.56	600.0	55.33	54.20	53.11	45.29	45.20	45.11	61.93	66.32	69.47	37.66	37.49	37.23
700.0	0.32	0.44	0.57	0.33	0.45	0.57	700.0	53.98	53.01	51.93	43.67	43.69	43.62	60.36	64.98	69.94	36.17	36.03	35.85
800.0	0.31	0.43	0.56	0.32	0.44	0.57	800.0	52.66	51.65	50.68	42.46	42.45	42.41	58.00	62.04	66.00	34.89	34.79	34.64
900.0	0.30	0.44	0.57	0.32	0.45	0.58	900.0	51.68	50.72	49.67	41.56	41.54	41.46	56.16	59.11	62.16	33.90	33.79	33.62
1000.0	0.29	0.43	0.58	0.31	0.45	0.59	1000.0	50.63	49.67	48.73	40.25	40.29	40.32	55.63	58.49	60.36	32.91	32.81	32.65
1100.0	0.28	0.42	0.57	0.30	0.44	0.58	1100.0	50.21	49.09	48.16	39.32	39.40	39.43	55.02	58.05	60.06	31.86	31.84	31.75
1200.0	0.28	0.43	0.58	0.29	0.44	0.59	1200.0	49.23	48.21	47.22	38.60	38.67	38.71	52.83	55.69	58.15	31.06	31.05	30.99
1300.0	0.27	0.43	0.59	0.28	0.44	0.59	1300.0	48.48	47.58	46.50	37.73	37.85	37.95	51.34	53.42	55.27	30.44	30.43	30.37
1400.0	0.25	0.41	0.58	0.27	0.43	0.59	1400.0	47.91	46.91	45.90	37.26	37.36	37.44	50.64	52.68	54.05	29.71	29.74	29.71
1500.0	0.25	0.41	0.58	0.26	0.43	0.59	1500.0	46.91	46.09	45.21	36.45	36.60	36.72	49.57	51.40	52.60	29.20	29.22	29.19
1600.0	0.25	0.42	0.60	0.25	0.43	0.60	1600.0	46.83	45.89	44.80	35.92	36.09	36.18	49.40	51.08	52.08	28.56	28.60	28.56
1700.0	0.23	0.41	0.59	0.25	0.42	0.60	1700.0	45.95	45.11	44.21	35.63	35.73	35.82	47.98	49.71	51.06	28.09	28.14	28.16
1800.0	0.22	0.40	0.58	0.24	0.41	0.59	1800.0	45.98	44.99	43.98	35.13	35.26	35.34	46.66	47.99	49.09	27.85	27.86	27.79
1900.0	0.23	0.41	0.60	0.24	0.42	0.61	1900.0	45.27	44.17	43.29	34.86	34.94	34.97	46.51	47.74	48.82	27.28	27.30	27.27
2000.0	0.21	0.40	0.59	0.23	0.42	0.60	2000.0	43.97	43.30	42.39	34.39	34.46	34.52	45.32	46.39	47.22	27.02	27.02	26.96
2100.0	0.19	0.38	0.57	0.21	0.40	0.59	2100.0	44.18	43.17	42.28	33.93	33.99	34.04	45.29	46.16	46.72	26.41	26.43	26.38
2200.0	0.19	0.38	0.58	0.22	0.40	0.60	2200.0	43.17	42.27	41.26	33.84	33.85	33.83	44.99	46.32	47.33	26.05	26.08	26.02
2300.0	0.18	0.38	0.58	0.21	0.39	0.59	2300.0	42.30	41.52	40.72	33.11	33.17	33.19	43.09	43.91	44.63	26.03	25.99	25.85
2400.0	0.16	0.35	0.56	0.17	0.37	0.57	2400.0	42.33	41.46	40.57	32.68	32.71	32.73	43.62	44.33	44.67	25.20	25.20	25.14
2500.0	0.15	0.36	0.57	0.16	0.36	0.57	2500.0	41.62	40.82	40.11	32.34	32.39	32.40	43.31	44.28	44.84	24.97	24.95	24.90
2600.0	0.14	0.35	0.57	0.15	0.36	0.57	2600.0	40.77	40.16	39.55	31.58	31.66	31.73	41.94	42.64	43.04	24.50	24.53	24.48
2700.0	0.13	0.35	0.58	0.14	0.35	0.57	2700.0	40.55	39.85	39.33	31.33	31.41	31.45	42.73	43.46	43.92	23.93	23.97	23.95
2800.0	0.14	0.36	0.61	0.16	0.38	0.61	2800.0	39.85	39.22	38.67	30.89	31.04	31.13	41.73	42.72	43.52	23.91	23.93	23.91



P.O. Box 350166, Brooklyn, New York 11235-0003 (718) 934-4500 • Fax (718) 332-4661 For detailed performance specs & shopping online see Mini-Circuits web site



The Design Engineers Search Engine Provides ACTUAL Data Instantly From MINI-CIRCUITS At: www.minicircuits.com

IF/RF MICROWAVE COMPONENTS

REV. OR  
JSW6-33DR+  
3/18/2014  
Page 8 of 9

Typical Performance Data

RF FREQ (MHz)	VSWR (:1) @ VDD=+4.8 OVER TEMPERATURE (ON STATE)												RF FREQ (MHz)	VSWR (:1) @ VDD=+4.8V OVER TEMPERATURE (OFF STATE)					
	RF COM						RF1			RF6				RF1			RF6		
	(RF1 ON)			(RF6 ON)			(RF1 ON)			(RF6 ON)				(RF2 ON)			(RF1 ON)		
	-45°C	+25°C	+90°C	-45°C	+25°C	+90°C	-45°C	+25°C	+90°C	-45°C	+25°C	+90°C		-45°C	+25°C	+90°C	-45°C	+25°C	+90°C
10.0	1.06	1.07	1.08	1.05	1.06	1.08	1.06	1.07	1.08	1.05	1.06	1.07	10.0	4.31	3.36	2.67	4.38	3.38	2.69
20.0	1.05	1.06	1.08	1.05	1.06	1.08	1.05	1.06	1.08	1.05	1.06	1.08	20.0	4.27	3.34	2.66	4.35	3.37	2.68
30.0	1.05	1.06	1.08	1.05	1.06	1.08	1.05	1.06	1.08	1.05	1.06	1.08	30.0	4.27	3.34	2.66	4.35	3.38	2.68
40.0	1.05	1.06	1.08	1.05	1.06	1.08	1.05	1.06	1.08	1.05	1.06	1.08	40.0	4.27	3.34	2.66	4.35	3.38	2.68
50.0	1.05	1.07	1.08	1.05	1.06	1.08	1.05	1.06	1.08	1.05	1.06	1.08	50.0	4.26	3.34	2.66	4.33	3.36	2.68
60.0	1.05	1.07	1.09	1.05	1.07	1.09	1.05	1.06	1.08	1.05	1.06	1.08	60.0	4.26	3.34	2.66	4.32	3.35	2.67
70.0	1.05	1.07	1.09	1.05	1.07	1.09	1.05	1.06	1.08	1.05	1.06	1.08	70.0	4.25	3.33	2.66	4.32	3.35	2.68
80.0	1.05	1.07	1.08	1.05	1.07	1.08	1.05	1.06	1.08	1.05	1.06	1.08	80.0	4.25	3.33	2.66	4.32	3.36	2.68
90.0	1.05	1.07	1.09	1.05	1.07	1.09	1.05	1.06	1.08	1.05	1.06	1.08	90.0	4.25	3.33	2.66	4.33	3.37	2.68
100.0	1.05	1.07	1.09	1.06	1.07	1.09	1.04	1.06	1.08	1.05	1.06	1.08	100.0	4.24	3.33	2.67	4.33	3.37	2.69
200.0	1.05	1.07	1.08	1.05	1.07	1.09	1.05	1.07	1.09	1.05	1.07	1.09	200.0	4.22	3.31	2.66	4.29	3.33	2.67
300.0	1.06	1.08	1.10	1.08	1.09	1.11	1.06	1.08	1.10	1.09	1.10	1.12	300.0	4.23	3.30	2.63	4.29	3.32	2.64
400.0	1.08	1.10	1.12	1.10	1.11	1.13	1.05	1.07	1.09	1.09	1.11	1.12	400.0	4.24	3.30	2.62	4.25	3.28	2.61
500.0	1.08	1.10	1.11	1.09	1.11	1.12	1.07	1.08	1.10	1.11	1.13	1.15	500.0	4.22	3.29	2.62	4.20	3.24	2.57
600.0	1.10	1.12	1.14	1.12	1.14	1.15	1.08	1.10	1.12	1.14	1.16	1.18	600.0	4.20	3.26	2.58	4.15	3.20	2.53
700.0	1.11	1.13	1.14	1.12	1.13	1.15	1.06	1.08	1.09	1.13	1.15	1.16	700.0	4.21	3.25	2.55	4.10	3.14	2.48
800.0	1.09	1.11	1.12	1.11	1.12	1.12	1.07	1.09	1.09	1.14	1.15	1.17	800.0	4.19	3.23	2.56	4.08	3.13	2.47
900.0	1.10	1.13	1.14	1.13	1.14	1.15	1.08	1.09	1.11	1.16	1.18	1.19	900.0	4.16	3.21	2.53	4.01	3.06	2.43
1000.0	1.10	1.12	1.14	1.11	1.11	1.13	1.05	1.06	1.07	1.13	1.14	1.15	1000.0	4.19	3.20	2.51	4.01	3.05	2.39
1100.0	1.08	1.09	1.10	1.09	1.08	1.07	1.06	1.06	1.07	1.14	1.15	1.16	1100.0	4.18	3.20	2.53	3.95	3.01	2.37
1200.0	1.11	1.12	1.13	1.12	1.12	1.11	1.07	1.07	1.08	1.14	1.15	1.16	1200.0	4.17	3.20	2.53	3.96	3.02	2.39
1300.0	1.12	1.13	1.15	1.09	1.09	1.11	1.04	1.03	1.03	1.09	1.10	1.10	1300.0	4.17	3.18	2.51	3.94	3.00	2.38
1400.0	1.06	1.08	1.11	1.04	1.03	1.04	1.02	1.04	1.06	1.10	1.12	1.13	1400.0	4.16	3.19	2.53	3.91	3.00	2.39
1500.0	1.09	1.10	1.11	1.07	1.06	1.06	1.03	1.03	1.04	1.10	1.12	1.13	1500.0	4.18	3.21	2.56	3.94	3.00	2.39
1600.0	1.14	1.15	1.17	1.06	1.08	1.09	1.05	1.03	1.04	1.05	1.07	1.09	1600.0	4.20	3.20	2.54	3.92	3.00	2.39
1700.0	1.10	1.13	1.14	1.06	1.08	1.10	1.07	1.09	1.10	1.11	1.14	1.16	1700.0	4.21	3.23	2.57	3.99	3.07	2.43
1800.0	1.08	1.10	1.10	1.04	1.05	1.06	1.04	1.05	1.06	1.09	1.12	1.14	1800.0	4.24	3.27	2.61	4.08	3.13	2.50
1900.0	1.17	1.17	1.18	1.13	1.14	1.14	1.10	1.09	1.08	1.11	1.12	1.12	1900.0	4.28	3.29	2.62	4.17	3.20	2.57
2000.0	1.17	1.18	1.17	1.17	1.17	1.16	1.15	1.15	1.14	1.19	1.19	1.19	2000.0	4.34	3.33	2.66	4.27	3.25	2.60
2100.0	1.09	1.09	1.09	1.10	1.11	1.10	1.10	1.10	1.09	1.14	1.16	1.16	2100.0	4.40	3.39	2.70	4.39	3.37	2.68
2200.0	1.16	1.16	1.15	1.18	1.17	1.16	1.12	1.11	1.08	1.16	1.15	1.13	2200.0	4.42	3.41	2.69	4.51	3.48	2.75
2300.0	1.17	1.16	1.14	1.20	1.18	1.16	1.17	1.16	1.14	1.21	1.19	1.16	2300.0	4.50	3.43	2.75	4.67	3.56	2.82
2400.0	1.07	1.05	1.03	1.08	1.07	1.05	1.12	1.11	1.11	1.13	1.13	1.12	2400.0	4.54	3.48	2.75	4.77	3.60	2.86
2500.0	1.07	1.06	1.07	1.10	1.10	1.11	1.08	1.07	1.06	1.09	1.07	1.06	2500.0	4.53	3.45	2.74	4.87	3.70	2.92
2600.0	1.09	1.07	1.05	1.09	1.08	1.08	1.13	1.12	1.10	1.10	1.09	1.07	2600.0	4.61	3.49	2.77	5.04	3.78	2.95
2700.0	1.09	1.08	1.08	1.06	1.07	1.08	1.13	1.14	1.15	1.08	1.10	1.11	2700.0	4.67	3.54	2.76	5.06	3.76	2.94
2800.0	1.09	1.11	1.13	1.13	1.16	1.18	1.09	1.12	1.13	1.09	1.10	1.11	2800.0	4.63	3.50	2.72	5.00	3.77	2.95



P.O. Box 350166, Brooklyn, New York 11235-0003 (718) 934-4500 • Fax (718) 332-4661 For detailed performance specs & shopping online see Mini-Circuits web site



The Design Engineers Search Engine Provides ACTUAL Data Instantly From MINI-CIRCUITS At: [www.minicircuits.com](http://www.minicircuits.com)

IF/RF MICROWAVE COMPONENTS

REV. OR  
JSW6-33DR+  
3/18/2014  
Page 9 of 9



## Typical Performance Curves

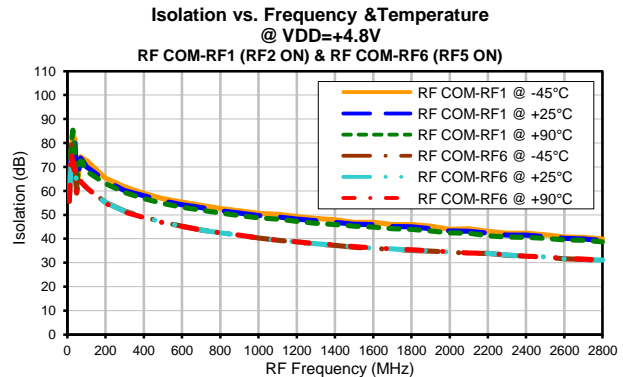
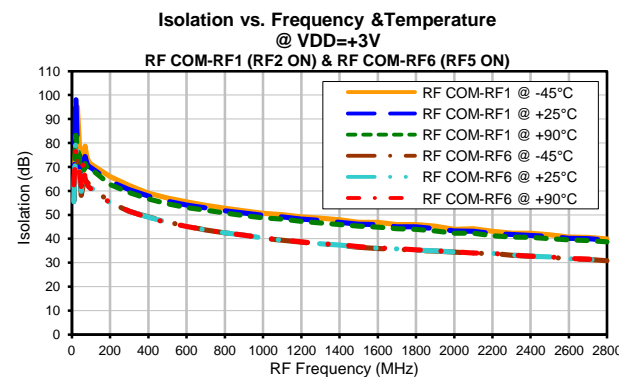
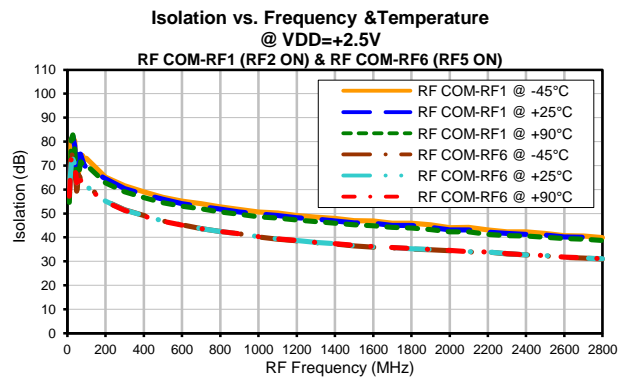
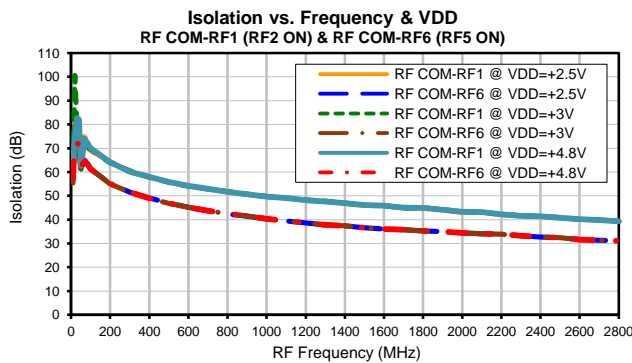
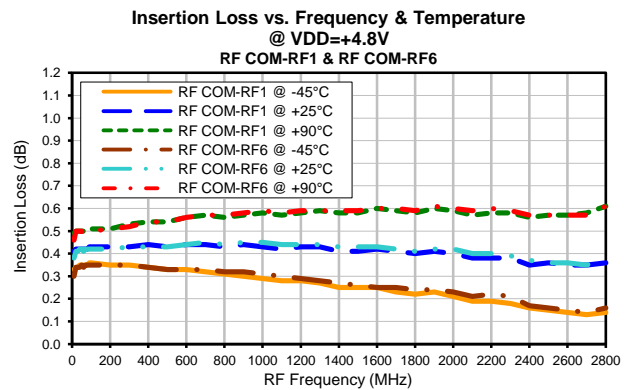
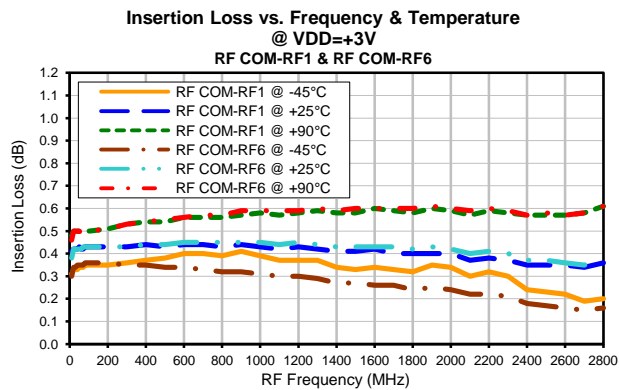
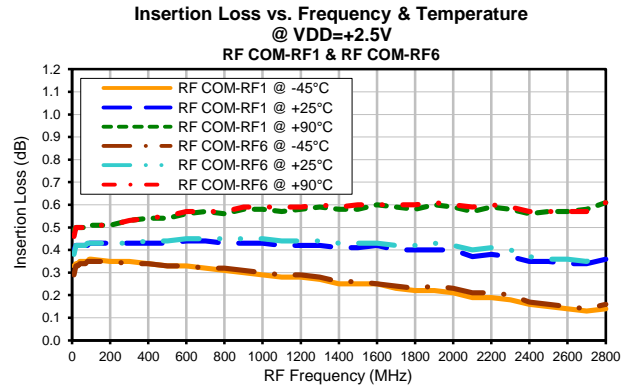
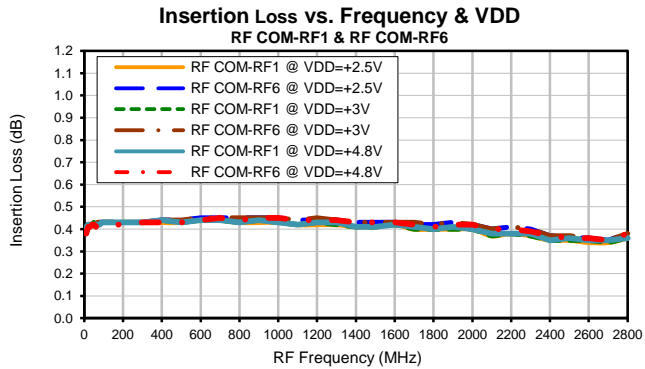

## Typical Performance Curves

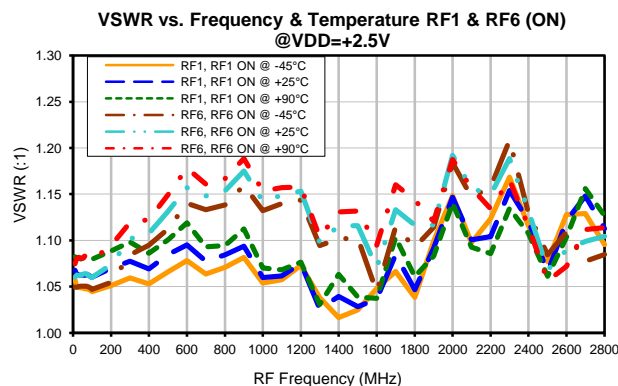
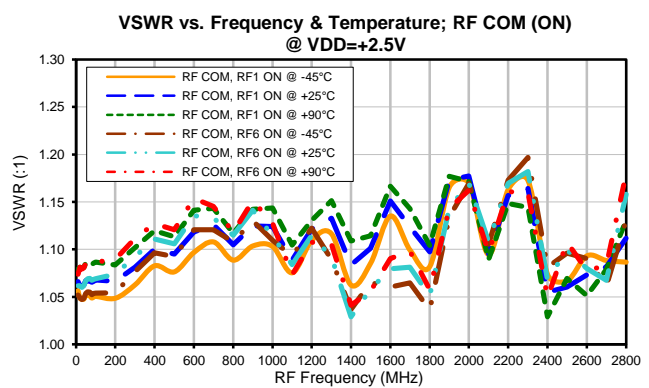
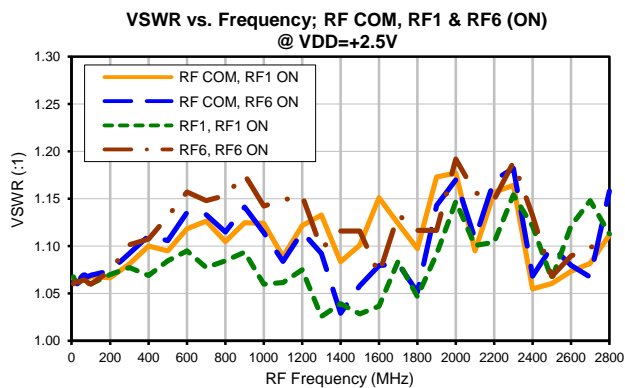
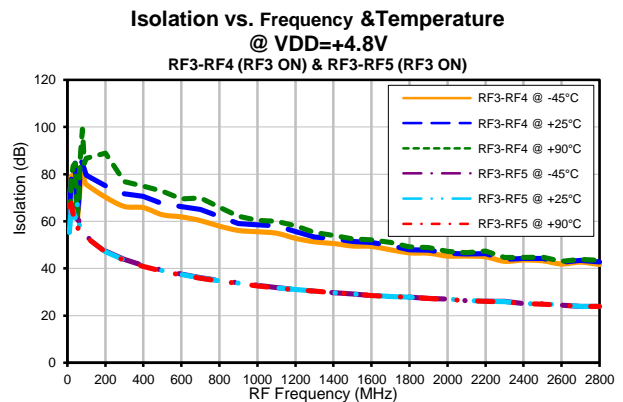
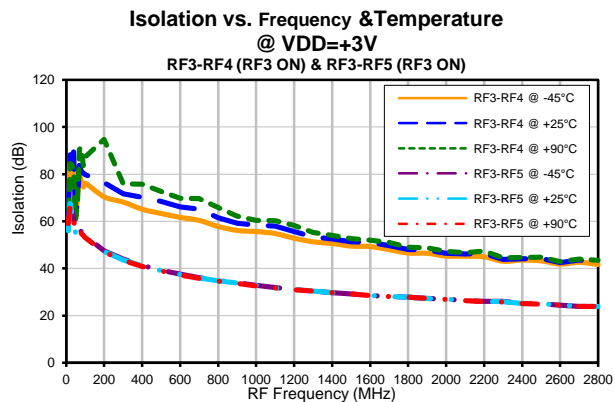
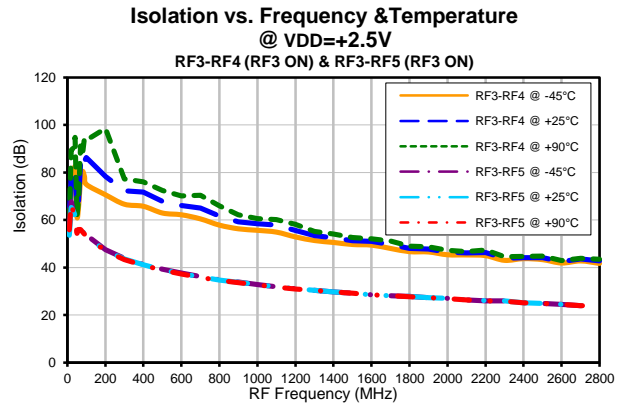
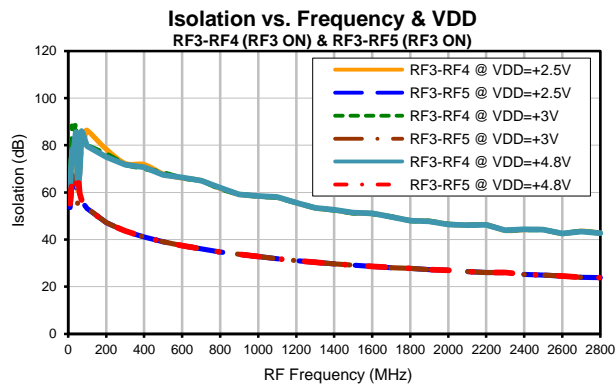

## Typical Performance Curves

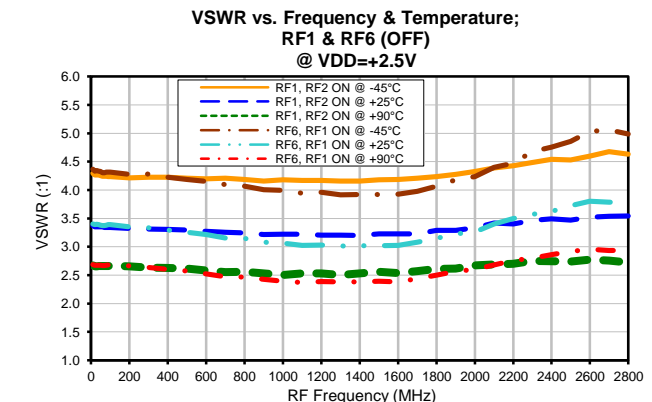
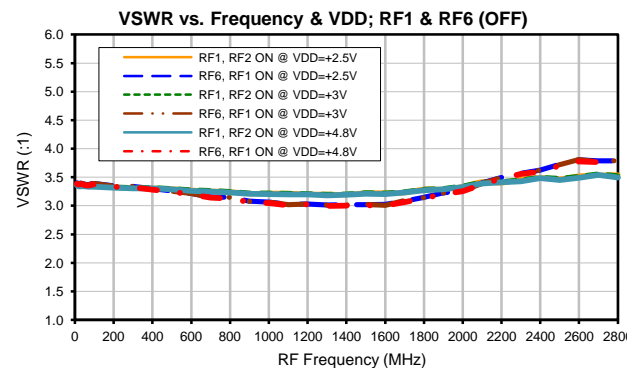
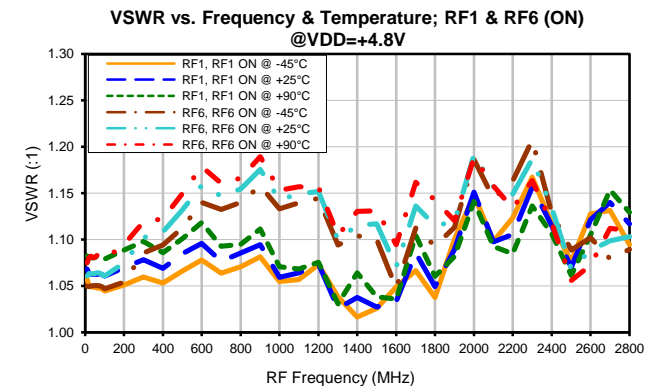
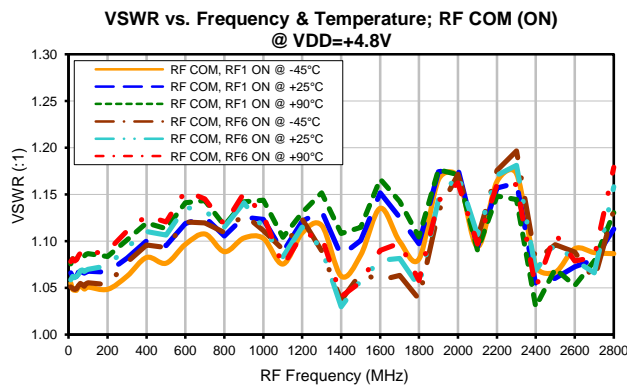
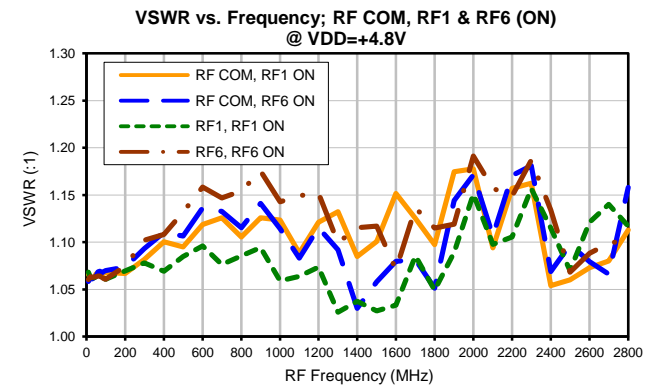
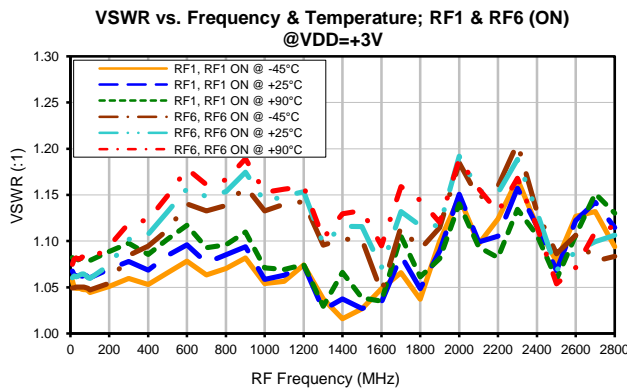
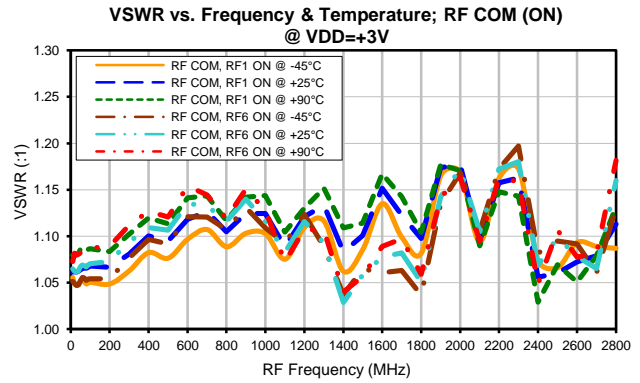
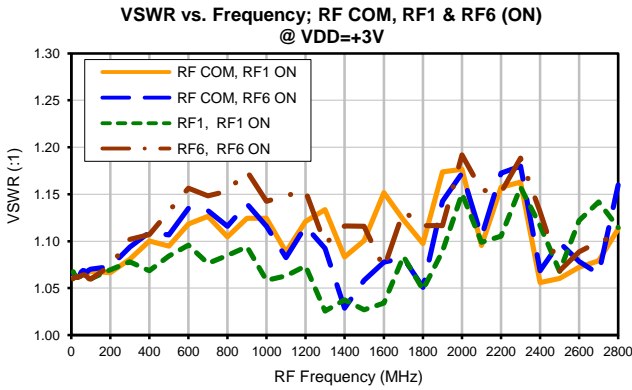

## Typical Performance Curves

VSWR vs. Frequency & Temperature;  
RF1 & RF6 (OFF)  
@ VDD=+3V

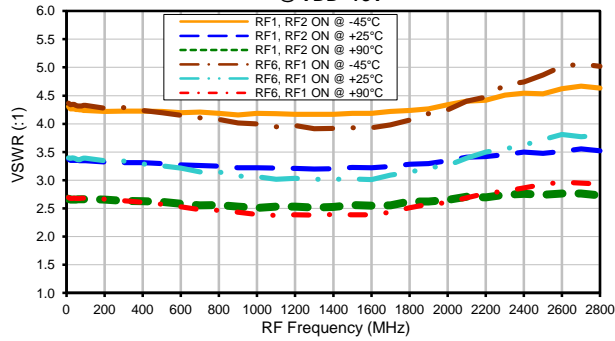

VSWR vs. Frequency & Temperature;  
RF1 & RF6 (OFF)  
@ VDD=+4.8V

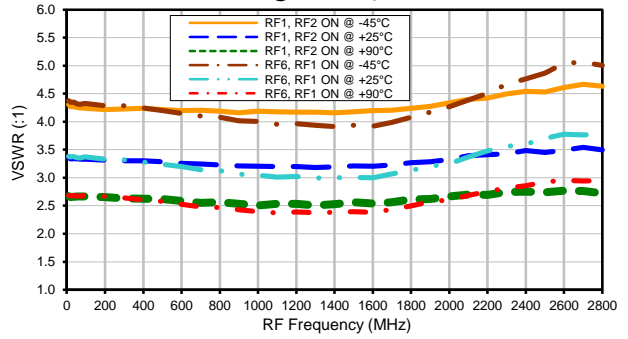

Input IP3 vs. Frequency

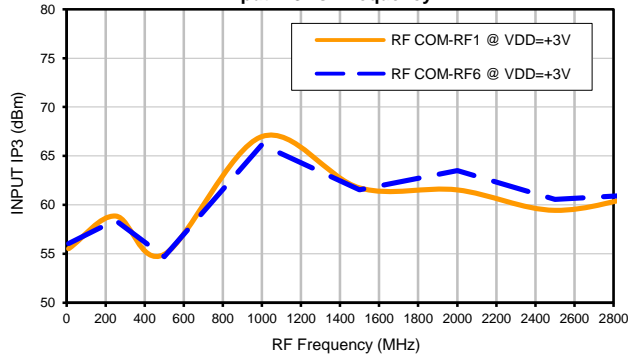

Compression vs. Frequency  
@ Fixed power (Pin=34.5 dBm)

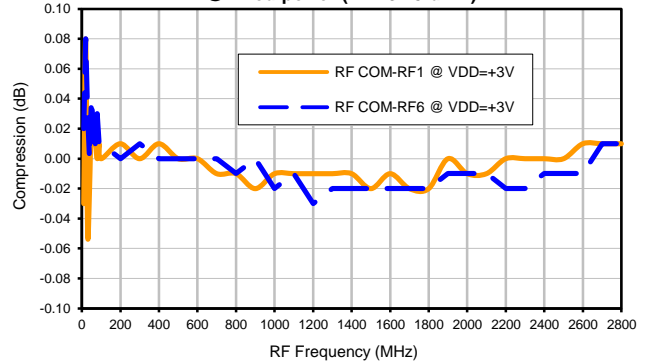

### Outline Dimensions

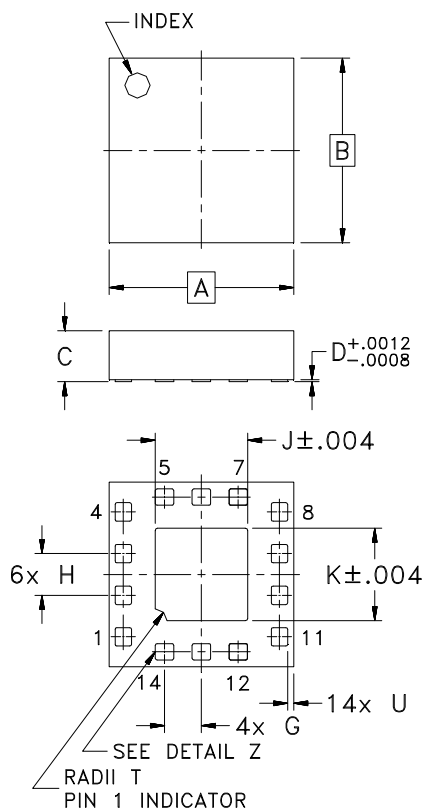

### PCB Land Pattern

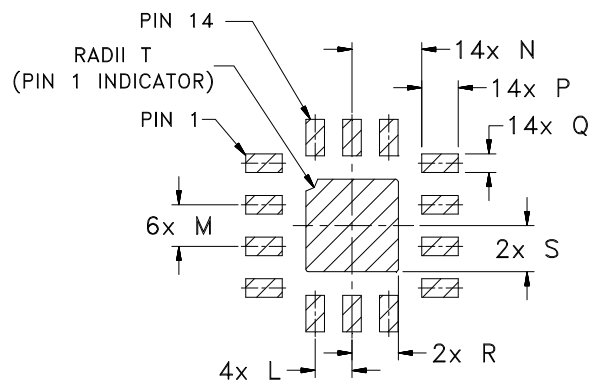

Suggested Layout,  
Tolerance to be within  $\pm .002$

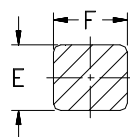

**DETAIL Z**  
SCALE 4:1  
3X THIS ROTATION  
3X ROTATED 180°  
4X ROTATED 90°CW  
4X ROTATED 90°CCW

CASE#	A	B	C	D	E	F	G	H	J	K	L	M	N
MT1817	.079 (2.00)	.079 (2.00)	.022 (0.55)	.0008 (0.02)	.007 (0.18)	.008 (0.20)	.016 (0.40)	.018 (0.45)	.039 (1.00)	.039 (1.00)	.016 (0.40)	.018 (0.45)	.030 (0.75)

CASE#	P	Q	R	S	T	U	WT, GRAM
MT1817	.016 (0.40)	.008 (0.20)	.020 (0.50)	.020 (0.50)	.005 (0.13)	.003 (0.065)	.008

Dimensions are in inches (mm). Tolerances: 3 Pl.  $\pm .002$

#### Notes:

1. Case material: Plastic.
2. Termination finish: Matte Tin.



INTERNET <http://www.minicircuits.com>

P.O. Box 350166, Brooklyn, New York 11235-0003 (718) 934-4500 Fax (718) 332-4661

Distribution Centers NORTH AMERICA 800-654-7949 • 417-335-5935 • Fax 417-335-5945 • EUROPE 44-1252-832600 • Fax 44-1252-837010

Mini-Circuits ISO 9001 & ISO 14001 Certified

# Tape & Reel Packaging TR-F108

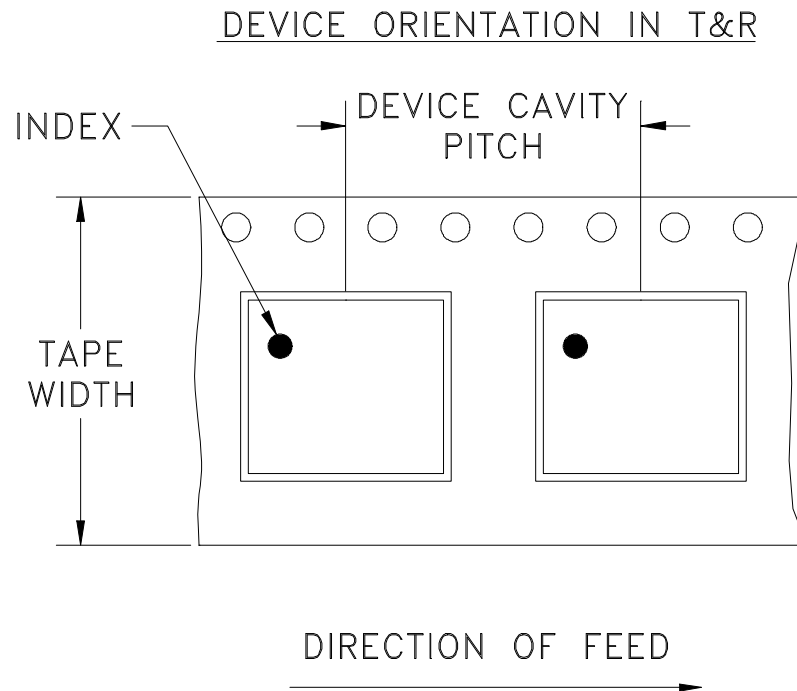

Tape Width, mm	Device Cavity Pitch, mm	Reel Size, inches	Devices per Reel	
12	4	7	Small quantity standards	20
				50
				100
				200
				500
				1000
		7	Standard	2000
				3000

Note: Please Consult individual data sheet to determine device per reel availability

Mini-Circuits carrier tape materials provide protection from ESD (Electro-Static Discharge) during handling and transportation. Tapes are static dissipative and comply with industry standards EIA-481/EIA-541.

Go to: [www.minicircuits.com/pages/pdfs/tape.pdf](http://www.minicircuits.com/pages/pdfs/tape.pdf)

**Mini-Circuits®**

INTERNET <http://www.minicircuits.com>

P.O. Box 350166, Brooklyn, New York 11235-0003 (718) 934-4500 Fax (718) 332-4661

Distribution Centers NORTH AMERICA 800-654-7949 • 417-335-5935 • Fax 417-335-5945 • EUROPE 44-1252-832600 • Fax 44-1252-837010

Mini-Circuits ISO 9001 & ISO 14001 Certified

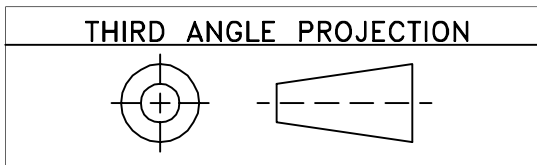

REVISIONS					
REV OR	ECN No.	DESCRIPTION	DATE	DR	AUTH
	M145644	NEW RELEASE	03/14/14	AV	RS

**SUGGESTED MOUNTING CONFIGURATION  
FOR MT1817 CASE STYLE, "14SW02" PIN CODE**

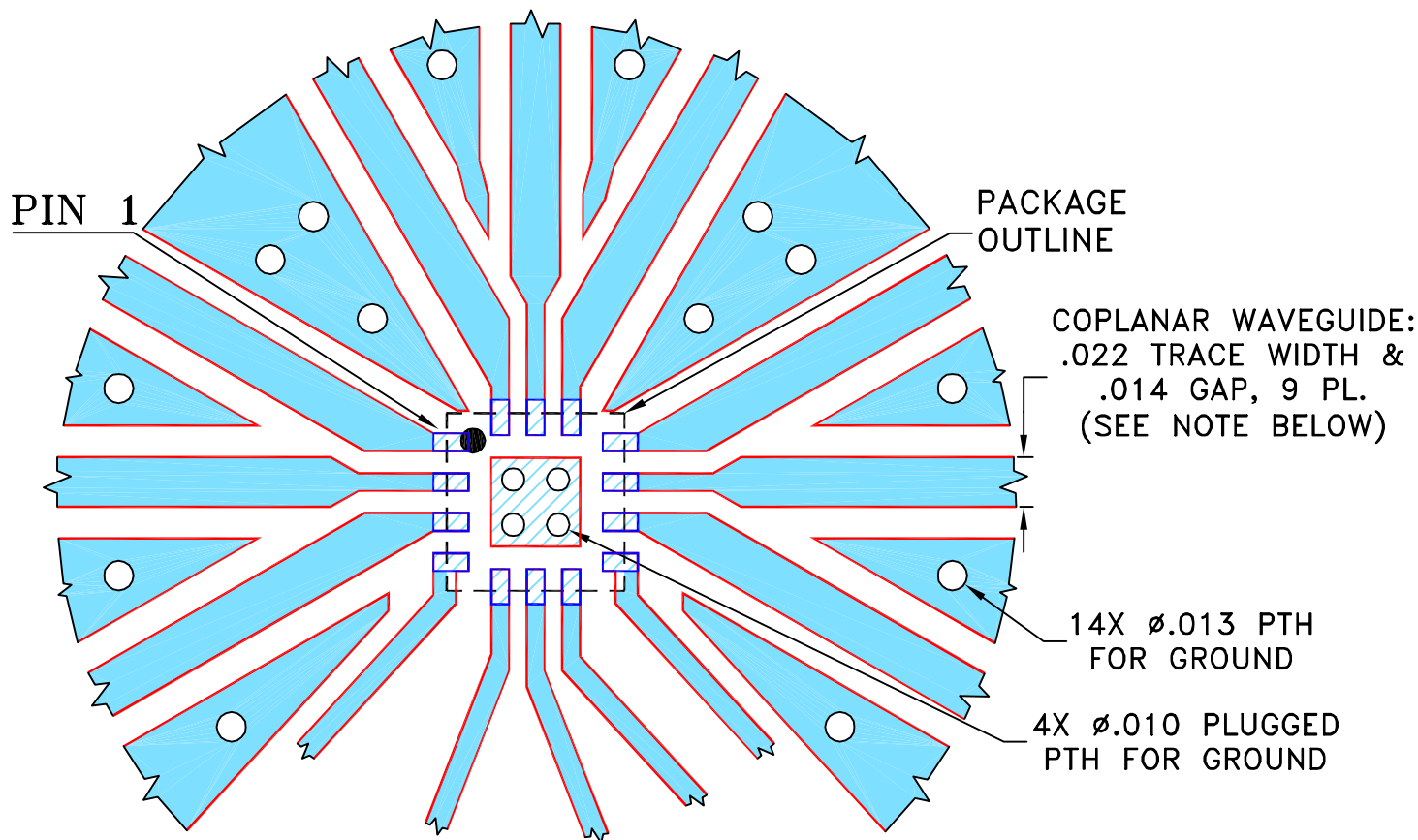

**NOTES:**

1. TRACE WIDTH IS SHOWN FOR ROGERS RO4350B WITH DIELECTRIC THICKNESS  $.010'' \pm .001''$ . COPPER: 1/2 OZ. EACH SIDE. FOR OTHER MATERIALS TRACE WIDTH AND GAP MAY NEED TO BE MODIFIED.
2. BOTTOM SIDE OF THE PCB IS CONTINUOUS GROUND PLANE.

- DENOTES PCB COPPER LAYOUT WITH SMOBC (SOLDER MASK OVER BARE COPPER).
- DENOTES COPPER LAND PATTERN FREE OF SOLDER MASK.

UNLESS OTHERWISE SPECIFIED	INITIALS	DATE
DIMENSIONS ARE IN INCHES	DRAWN AV	03/13/14
TOLERANCES ON:	CHECKED IL	03/13/14
2 PL DECIMALS $\pm$	APPROVED RS	03/14/14
3 PL DECIMALS $\pm$ .005		
ANGLES $\pm$		
FRACTIONS $\pm$		

**Mini-Circuits<sup>®</sup>** 13 Neptune Avenue  
Brooklyn NY 11235

**PL, 14SW02, MT1817, TB-724+**

Mini-Circuits<sup>®</sup>  
THIS DOCUMENT AND ITS CONTENTS ARE THE PROPERTY OF MINI-CIRCUITS. EXCEPT FOR USE EXPRESSLY GRANTED, IN WRITING, TO ITS VENDORS, VENDEE AND THE UNITED STATES GOVERNMENT, MINI-CIRCUITS RESERVES ALL PROPRIETARY DESIGN, USE, MANUFACTURING AND REPRODUCTION RIGHTS THERETO. THESE CONTENTS SHALL NOT BE USED, DUPLICATED OR DISCLOSED TO ANY OUTSIDE PARTY, IN WHOLE OR IN PART, WITHOUT WRITTEN PERMISSION OF MINI-CIRCUITS.

ASHEETA1.DWG REV:A DATE:01/12/95

SIZE	CODE IDENT	DRAWING NO:	REV:
A	15542	98-PL-416	OR
FILE:	98PL416	SCALE: 12:1	SHEET: 1 OF 1

# Evaluation Board and Circuit

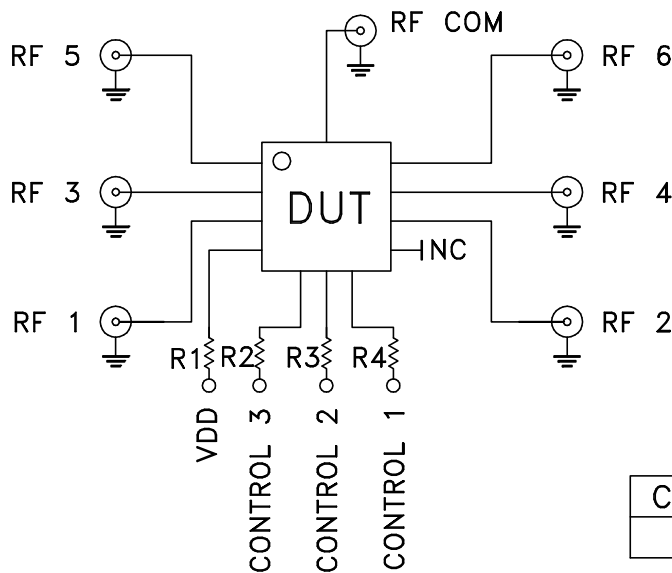
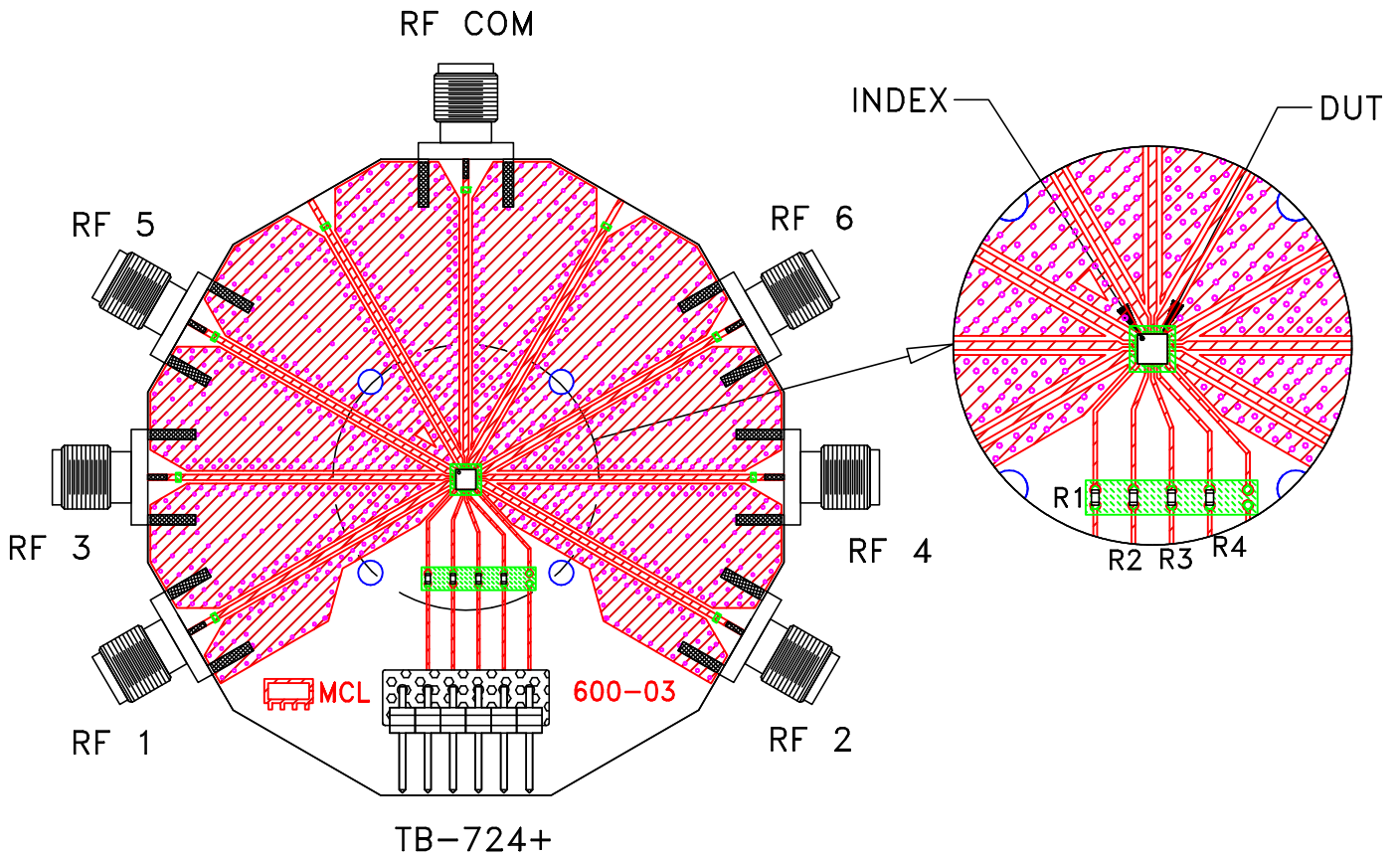

COMPONENT	VALUE	SIZE
R1-R4	1 kOhm	0402

Schematic Diagram

## Notes:

1. 50 Ohm SMA Female connectors.
2. PCB Material: RO4350 or equivalent,  
Dielectric Constant=3.5,  
Thickness=.010 inch.

 **Mini-Circuits®**



All Mini-Circuits products are manufactured under exacting quality assurance and control standards, and are capable of meeting published specifications after being subjected to any or all of the following physical and environmental test.

Specification	Test/Inspection Condition	Reference/Spec
Operating Temperature	-40° to 85° C Ambient Environment	Individual Model Data Sheet
Storage Temperature	-65° to 150° C / -40° to 125° C / -55° to 150° C Ambient Environment	Individual Model Data Sheet
Temperature Cycling	-65° to 150°C, 500 cycles	JESD22-A104, condition C
HAST	130°C, 85% RH, 33 PSIA, 96 hours, nominal bias	JESD22-A110
High Temp Storage	150°C 1000 hours	JESD22-A103
Solderability	Per Reference Spec	JESD22-B102
Moisture Sensitivity: Level 1	Bake at 125°C for 24 hours Soak at 85°C/85% RH for 168 hours, Reflow 3 cycles at 260°C peak	J-STD-020 D.01