



5 VOLT-SURFACE MOUNT

Monolithic Amplifier

GVA-84+

50Ω DC-7 GHz

THE BIG DEAL

- High Gain, 24 dB typ. at 100 MHz
- High Pout, P1dB 20.5 dBm typ. at 100 MHz
- High IP3, 37 dBm typ. at 100 MHz
- Ruggedized design
- Fixed 5V operation
- Unconditionally stable
- Excellent ESD Protection
- Transient protected, US patent 6,943,629

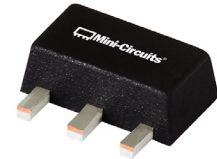

Generic photo used for illustration purposes only

CASE STYLE: DF782

+RoHS Compliant

The +Suffix identifies RoHS Compliance. See our web site for RoHS Compliance methodologies and qualifications

LTE Performance

APPLICATIONS

- Base station infrastructure
- Portable Wireless
- CATV & DBS
- MMDS & Wireless LAN
- LTE

PRODUCT OVERVIEW

GVA-84+ (RoHS compliant) is a wideband amplifier offering high dynamic range. Lead finish is SnAgNi. It has repeatable performance from lot to lot and is enclosed in a SOT-89 package. It uses patented Transient Protected Darlington configuration and is fabricated using InGaP HBT technology.

SIMPLIFIED SCHEMATIC AND PIN DESCRIPTION

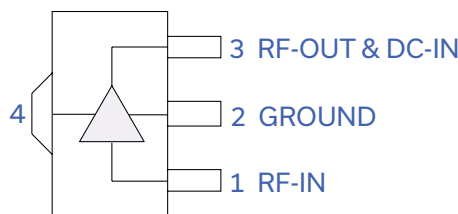
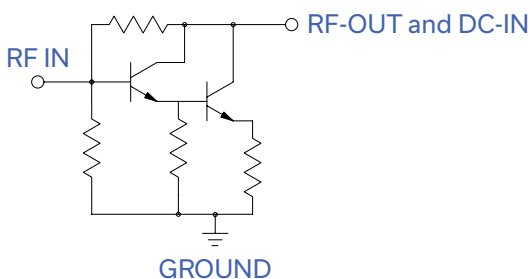

Function	Pin Number	Description
RF IN	1	RF input pin. This pin requires the use of an external DC blocking capacitor chosen for the frequency of operation.
RF-OUT and DC-IN	3	RF output and bias pin. DC voltage is present on this pin; therefore a DC blocking capacitor is necessary for proper operation. An RF choke is needed to feed DC bias without loss of RF signal due to the bias connection, as shown in "Recommended Application Circuit", Fig. 2
GND	2,4	Connections to ground. Use via holes as shown in "Suggested Layout for PCB Design" to reduce ground path inductance for best performance.

REV. E
ECO-010314
M151107
GVA-84+
ED-11756/5E
211026





5 VOLT-SURFACE MOUNT

Monolithic Amplifier

GVA-84+

Mini-Circuits

ELECTRICAL SPECIFICATIONS⁽¹⁾ AT 25°C AND 5V, UNLESS NOTED

Parameter	Condition (GHz)	Min.	Typ.	Max.	Units
Frequency Range ⁽²⁾		DC		7	GHz
Gain	0.1	22.9	24.1	25.3	dB
	1.0	—	21.7	—	
	2.0	17.4	18.4	19.9	
	3.0	—	16.0	—	
	4.0	13.8	14.6	16.3	
	6.0	—	12.5	—	
	7.0	—	10.5	—	
Magnitude of Gain Variation versus Temperature ⁽³⁾ (values are negative)	0.1	—	0.0004	—	dB/°C
	1.0	—	0.0021	—	
	2.0	—	0.0032	0.006	
	3.0	—	0.0044	—	
	4.0	—	0.0058	—	
	6.0	—	0.0131	—	
	7.0	—	0.0175	—	
Input Return Loss	0.1	—	22.9	—	dB
	1.0	—	20.6	—	
	2.0	15.0	18.5	—	
	3.0	—	18.1	—	
	4.0	—	19.1	—	
	6.0	—	17.9	—	
	7.0	—	11.9	—	
Output Return Loss	0.1	—	23.3	—	dB
	1.0	—	10.7	—	
	2.0	6.0	7.7	—	
	3.0	—	7.1	—	
	4.0	—	7.0	—	
	6.0	—	6.3	—	
	7.0	—	5.6	—	
Reverse Isolation	2.0		26.5		dB
Output Power @1 dB compression	0.1	19.4	20.4	—	dBm
	1.0	19.5	20.5	—	
	2.0	19.6	20.6	—	
	3.0	—	21.0	—	
	4.0	—	19.9	—	
	6.0	—	17.0	—	
	7.0	—	15.6	—	
Saturated Output Power (at 3dB compression)	0.1		21.7		dBm
	1.0		22.3		
	2.0		22.3		
	3.0		22.2		
	4.0		21.0		
	6.0		18.9		
	7.0		17.2		
Output IP3	0.1	33.0	36.7	—	dBm
	1.0	32.2	35.8	—	
	2.0	32.9	36.6	—	
	3.0	—	35.8	—	
	4.0	—	34.9	—	
	6.0	—	33.0	—	
	7.0	—	32.0	—	
Noise Figure	0.1	—	5.5	6.5	dB
	1.0	—	5.6	—	
	2.0	—	5.5	6.5	
	3.0	—	5.5	—	
	4.0	—	5.6	6.6	
	6.0	—	6.2	—	
	7.0	—	6.8	—	
Group Delay	2.0		94		psec
Device Operating Voltage		4.8	5.0	5.2	V
Device Operating Current		85	108	130	mA
Device Current Variation vs. Temperature			61.8		µA/°C
Device Current Variation vs Voltage			0.058		mA/mV
Thermal Resistance, junction-to-ground lead			64		°C/W





MAXIMUM RATINGS

Parameter	Ratings
Operating Temperature (ground lead)	-45°C to 85°C
Storage Temperature	-65°C to 150°C
Operating Current at 5V	160mA
Power Dissipation	1W
Input Power	13 dBm
DC Voltage on Pin 3	5.8V

Permanent damage may occur if any of these limits are exceeded.
Electrical maximum ratings are not intended for continuous normal operation.

CHARACTERIZATION TEST CIRCUIT

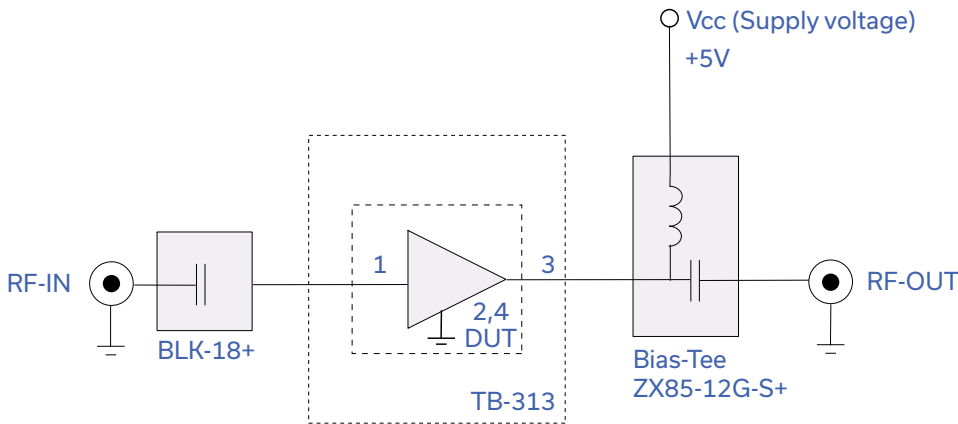

Fig 1. Block Diagram of Test Circuit used for characterization. (DUT soldered on Mini-Circuits Test Board TB-313)

Gain, Output power at 1dB compression (P1 dB) and output IP3 (OIP3) are measured using R&S Network Analyzer ZVA-24. Noise Figure measured using Agilent's N5242A PNA-X microwave network analyzer.

Conditions:

1. Gain and Return loss: Pin= -25dBm
2. Output IP3 (OIP3): Two tones, spaced 1 MHz apart, 0 dBm/tone at output.



RECOMMENDED APPLICATION CIRCUIT

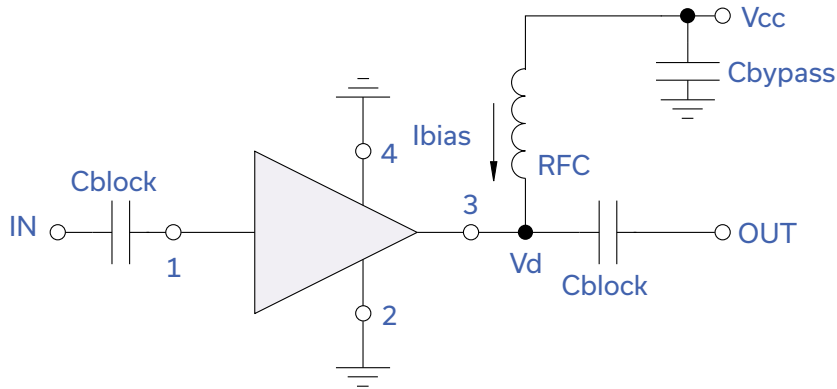
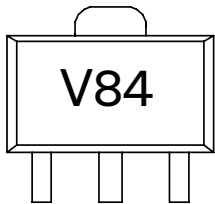

Fig 2. Test Board includes case, connectors, and components soldered to PCB.

PRODUCT MARKING



Marking may contain other features or characters for internal lot control



ADDITIONAL DETAILED TECHNICAL INFORMATION IS AVAILABLE ON OUR DASH BOARD. TO ACCESS [CLICK HERE](#)

Performance Data	Data Table
	Swept Graphs
	S-Parameter (S2P Files) Data Set (.zip file)
Case Style	DF782 (SOT 89) Plastic package, exposed paddle lead finish: matte-tin
Tape & Reel Standard quantities available on reel	F55 7" reels with 20, 50, 100, 200, 500 or 1K devices
Suggested Layout for PCB Design	PL-255
Evaluation Board	TB-410-84+
Environmental Ratings	ENV08T1

ESD RATING

Human Body Model (HBM): Class 1C (1000v to < 2000v) in accordance with ANSI/ESD STM 5.1 - 2001

Machine Model (MM): Class M2 (100V to < 200V) in accordance with ANSI/ESD STM 5.2 - 1999

MSL RATING

Moisture Sensitivity: MSL1 in accordance with IPC/JEDECJ-STD-020D

MSL TEST FLOW CHART

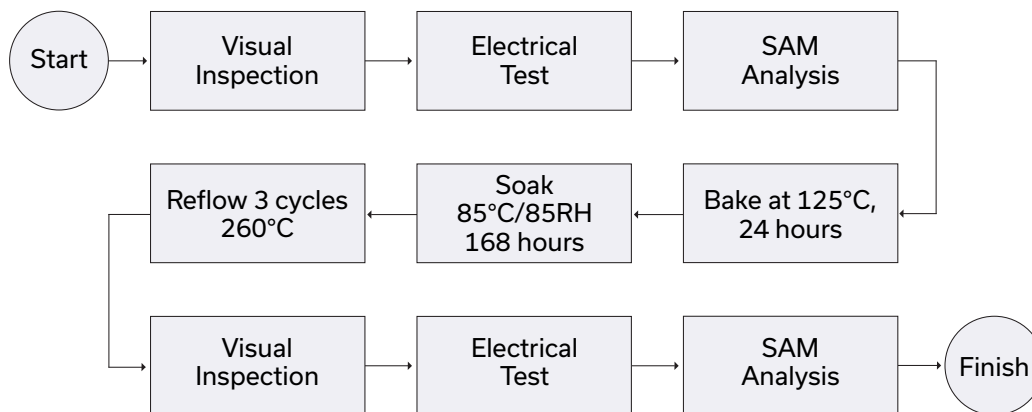

- NOTES**
- A. Performance and quality attributes and conditions not expressly stated in this specification document are intended to be excluded and do not form a part of this specification document.
 - B. Electrical specifications and performance data contained in this specification document are based on Mini-Circuit's applicable established test performance criteria and measurement instructions.
 - C. The parts covered by this specification document are subject to Mini-Circuits standard limited warranty and terms and conditions (collectively, "Standard Terms"); Purchasers of this part are entitled to the rights and benefits contained therein. For a full statement of the standard. Terms and the exclusive rights and remedies thereunder, please visit Mini-Circuits' website at www.minicircuits.com/MCLStore/terms.jsp

Typical Performance Data

**NOTE: Use PDF Bookmarks to view DATA at required conditions
or to view GRAPHS.**

Definitions:

Input Return Loss = -S11 (dB)

Gain(Power Gain) = S21 (dB)

Reverse Isolation = -S12 (dB)

Output Return Loss = -S22 (dB)

TEST CONDITIONS: Vd = 5.00V, Icc=106mA @Temperature = +25degC

FREQ	Gain	Isolation	Input Return Loss	Output Return Loss	Stability		IP3 Output	1dB Comp. Output	FREQ	Noise Figure
(MHz)	(dB)	(dB)	(dB)	(dB)	K	Delta	(dBm)	(dBm)	(MHz)	(dB)
50	24.18	31.36	21.65	24.37	1.34	0.43	36.98	20.73	50	5.53
100	24.11	31.36	21.72	23.67	1.35	0.43	36.83	20.77	100	5.65
200	23.98	31.07	21.79	20.65	1.33	0.44	36.80	20.73	200	5.65
400	23.62	30.73	21.59	16.17	1.32	0.44	36.48	20.89	400	5.77
600	23.07	30.40	21.19	13.38	1.31	0.43	36.05	20.71	600	5.70
800	22.44	29.97	20.64	11.57	1.31	0.42	36.17	20.74	800	5.78
1000	21.77	29.47	20.14	10.29	1.30	0.42	36.37	20.77	1000	5.73
1200	21.08	28.90	19.70	9.36	1.28	0.41	36.34	20.59	1200	5.71
1400	20.41	28.38	19.28	8.68	1.27	0.41	36.37	20.60	1400	5.73
1600	19.75	27.89	18.96	8.17	1.27	0.40	36.90	20.76	1600	5.75
1800	19.12	27.33	18.76	7.80	1.26	0.40	37.15	20.73	1800	5.69
2000	18.57	26.79	18.60	7.50	1.24	0.39	37.30	20.88	2000	5.67
2200	18.02	26.31	18.65	7.36	1.24	0.39	37.15	21.00	2200	5.66
2400	17.54	26.01	18.62	7.23	1.24	0.38	36.78	21.02	2400	5.63
2600	17.10	25.53	18.65	7.15	1.23	0.37	36.47	21.08	2600	5.59
2800	16.70	25.04	18.75	7.12	1.22	0.37	36.63	21.24	2800	5.59
3000	16.34	24.75	18.76	7.05	1.22	0.37	36.53	21.18	3000	5.70
3200	15.99	24.48	18.96	7.09	1.22	0.36	36.27	21.06	3200	5.62
3400	15.73	24.11	18.90	7.08	1.21	0.36	36.28	20.92	3400	5.70
3600	15.45	23.78	18.89	7.04	1.20	0.36	36.25	20.85	3600	5.64
3800	15.20	23.55	19.03	7.07	1.20	0.36	35.37	20.59	3800	5.77
4000	14.97	23.32	19.18	7.09	1.21	0.36	34.81	20.24	4000	5.82
4200	14.73	23.13	19.27	7.05	1.21	0.36	34.94	20.08	4200	6.09
4400	14.51	23.02	19.34	7.00	1.22	0.36	35.34	19.97	4400	5.93
4600	14.33	22.84	19.13	6.90	1.22	0.36	35.00	19.83	4600	5.93
4800	14.08	22.74	18.84	6.76	1.23	0.36	34.78	19.38	4800	5.84
5000	13.90	22.80	18.86	6.72	1.26	0.36	34.75	19.02	5000	6.04
5200	13.68	22.78	18.20	6.56	1.27	0.36	34.44	18.79	5200	6.18
5400	13.44	22.73	17.65	6.38	1.28	0.36	34.15	18.55	5400	6.30
5600	13.21	22.78	17.20	6.22	1.31	0.36	33.77	18.36	5600	6.26
5800	12.94	22.83	16.26	6.07	1.34	0.35	34.05	18.10	5800	6.18
6000	12.67	23.02	15.66	5.98	1.38	0.35	33.34	17.40	6000	6.33
6200	12.29	23.16	14.85	5.83	1.44	0.34	33.51	15.61	6500	6.30
6400	11.97	23.14	14.33	5.76	1.48	0.35	33.17	15.49	7000	6.78
6600	11.53	23.32	13.52	5.73	1.56	0.34	32.42	15.67	7500	6.99
6800	11.02	23.67	12.54	5.57	1.67	0.33	32.08	15.69	8000	7.42
7000	10.48	23.58	11.89	5.56	1.74	0.34	32.01	15.58	8500	8.07
7200	9.82	23.66	11.13	5.59	1.86	0.33	31.74	15.25	9000	8.51
7500	8.76	23.41	10.29	5.65	2.01	0.33	31.65	13.94	9500	9.06
8000	6.90	23.07	8.76	5.63	2.26	0.33	30.50	13.46	10000	9.32

REV. X1
GVA-84+
110601
Page 1 of 9



IF/RF MICROWAVE COMPONENTS • ISO 9001 ISO 14001 AS 9100 CERTIFIED • RoHS compliant
P.O. Box 350166, Brooklyn, New York 11235-0003 (718) 934-4500 Fax (718) 332-4661



The Design Engineers Search Engine finds the model you need, Instantly • For detailed performance specs & shopping online see



Typical Performance Data

Definitions:

Input Return Loss = -S11 (dB)

Gain(Power Gain) = S21 (dB)

Reverse Isolation = -S12 (dB)

Output Return Loss = -S22 (dB)

TEST CONDITIONS: Vd = 4.75V, Icc=92mA @Temperature = +25degC

FREQ	Gain	Isolation	Input Return Loss	Output Return Loss	Stability		IP3 Output	1dB Comp. Output	FREQ	Noise Figure
(MHz)	(dB)	(dB)	(dB)	(dB)	K	Delta	(dBm)	(dBm)	(MHz)	(dB)
50	24.01	30.66	23.55	22.45	1.29	0.46	34.47	19.75	50	5.39
100	23.94	30.94	23.43	21.88	1.33	0.44	34.28	19.78	100	5.51
200	23.80	30.69	23.32	19.66	1.31	0.45	34.34	19.73	200	5.51
400	23.46	30.71	22.93	15.79	1.33	0.43	34.14	19.80	400	5.62
600	22.92	30.33	22.08	13.18	1.32	0.42	33.91	19.66	600	5.55
800	22.29	29.85	21.27	11.43	1.30	0.42	34.24	19.66	800	5.68
1000	21.63	29.23	20.55	10.18	1.28	0.42	34.53	19.73	1000	5.60
1200	20.95	28.76	19.94	9.27	1.28	0.41	34.53	19.48	1200	5.58
1400	20.28	28.20	19.36	8.60	1.26	0.40	34.58	19.56	1400	5.61
1600	19.62	27.69	18.97	8.09	1.25	0.40	35.22	19.70	1600	5.63
1800	19.00	27.16	18.65	7.72	1.24	0.39	35.57	19.73	1800	5.56
2000	18.44	26.64	18.45	7.42	1.23	0.39	35.77	19.89	2000	5.51
2200	17.90	26.30	18.43	7.27	1.24	0.38	35.66	20.05	2200	5.52
2400	17.42	25.79	18.40	7.15	1.22	0.38	35.51	20.12	2400	5.45
2600	16.99	25.40	18.40	7.07	1.22	0.37	35.22	20.11	2600	5.46
2800	16.59	24.99	18.43	7.05	1.21	0.37	35.17	20.27	2800	5.45
3000	16.22	24.68	18.40	6.96	1.21	0.36	35.20	20.37	3000	5.53
3200	15.88	24.38	18.59	7.01	1.22	0.36	35.12	20.21	3200	5.49
3400	15.61	24.05	18.51	6.99	1.21	0.36	35.11	20.12	3400	5.58
3600	15.33	23.74	18.52	6.97	1.20	0.36	35.04	20.09	3600	5.48
3800	15.08	23.55	18.64	7.01	1.21	0.35	34.06	19.85	3800	5.63
4000	14.86	23.24	18.79	7.02	1.20	0.36	33.57	19.51	4000	5.64
4200	14.61	23.10	18.89	7.00	1.21	0.35	33.60	19.39	4200	5.91
4400	14.39	22.97	18.98	6.97	1.22	0.35	33.88	19.25	4400	5.74
4600	14.21	22.80	18.77	6.87	1.22	0.36	33.46	19.13	4600	5.78
4800	13.96	22.70	18.53	6.74	1.23	0.36	33.49	18.70	4800	5.69
5000	13.76	22.78	18.54	6.71	1.27	0.35	33.31	18.39	5000	5.87
5200	13.54	22.73	17.94	6.57	1.28	0.35	32.92	18.15	5200	6.01
5400	13.29	22.70	17.42	6.38	1.30	0.35	32.74	17.86	5400	6.11
5600	13.05	22.72	16.99	6.24	1.32	0.35	32.27	17.71	5600	6.08
5800	12.78	22.84	16.09	6.11	1.36	0.35	32.08	17.43	5800	6.01
6000	12.50	23.03	15.54	6.02	1.41	0.34	32.02	16.81	6000	6.14
6200	12.13	23.16	14.74	5.88	1.46	0.34	32.17	15.01	6500	6.15
6400	11.80	23.12	14.23	5.83	1.50	0.34	31.48	14.85	7000	6.57
6600	11.34	23.32	13.43	5.79	1.59	0.33	31.17	15.02	7500	6.79
6800	10.84	23.67	12.50	5.64	1.71	0.33	30.63	15.09	8000	7.19
7000	10.31	23.56	11.85	5.63	1.77	0.33	30.70	15.01	8500	7.84
7200	9.64	23.67	11.11	5.68	1.90	0.32	30.43	14.76	9000	8.28
7500	8.59	23.39	10.27	5.74	2.05	0.33	30.21	13.37	9500	8.88
8000	6.74	23.06	8.75	5.72	2.31	0.33	29.19	13.00	10000	8.98

REV. X1
GVA-84+
110601
Page 2 of 9



IF/RF MICROWAVE COMPONENTS • ISO 9001 ISO 14001 AS 9100 CERTIFIED • RoHS compliant
P.O. Box 350166, Brooklyn, New York 11235-0003 (718) 934-4500 Fax (718) 332-4661



The Design Engineers Search Engine finds the model you need, Instantly • For detailed performance specs & shopping online see



Typical Performance Data

Definitions:

Input Return Loss = -S11 (dB)

Gain(Power Gain) = S21 (dB)

Reverse Isolation = -S12 (dB)

Output Return Loss = -S22 (dB)

TEST CONDITIONS: Vd = 5.25V, Icc=121mA @Temperature = +25degC

FREQ	Gain	Isolation	Input Return Loss	Output Return Loss	Stability		IP3 Output	1dB Comp. Output	FREQ	Noise Figure
(MHz)	(dB)	(dB)	(dB)	(dB)	K	Delta	(dBm)	(dBm)	(MHz)	(dB)
50	24.30	31.09	20.87	26.72	1.31	0.45	39.25	21.50	50	5.65
100	24.23	30.81	20.63	25.17	1.28	0.47	39.11	21.55	100	5.77
200	24.09	31.45	20.75	21.34	1.36	0.43	38.96	21.53	200	5.78
400	23.74	31.14	20.72	16.43	1.35	0.43	38.46	21.65	400	5.88
600	23.18	30.63	20.46	13.52	1.33	0.43	37.68	21.51	600	5.83
800	22.55	30.13	20.16	11.67	1.32	0.42	37.47	21.52	800	5.92
1000	21.87	29.60	19.81	10.38	1.30	0.42	37.58	21.52	1000	5.87
1200	21.18	29.05	19.48	9.43	1.29	0.41	37.44	21.41	1200	5.86
1400	20.50	28.51	19.17	8.76	1.28	0.41	37.34	21.40	1400	5.88
1600	19.83	27.90	18.93	8.25	1.27	0.41	37.72	21.52	1600	5.88
1800	19.22	27.46	18.78	7.88	1.27	0.40	37.83	21.48	1800	5.82
2000	18.66	26.99	18.68	7.58	1.26	0.39	38.02	21.61	2000	5.77
2200	18.11	26.45	18.75	7.42	1.25	0.39	37.65	21.73	2200	5.80
2400	17.63	26.03	18.77	7.31	1.25	0.38	37.36	21.74	2400	5.75
2600	17.19	25.59	18.82	7.22	1.24	0.38	36.99	21.77	2600	5.73
2800	16.79	25.21	18.92	7.18	1.23	0.37	37.21	21.90	2800	5.75
3000	16.42	24.80	18.96	7.12	1.22	0.37	37.11	21.88	3000	5.83
3200	16.08	24.53	19.18	7.15	1.23	0.36	36.82	21.67	3200	5.77
3400	15.81	24.14	19.12	7.14	1.21	0.37	36.72	21.44	3400	5.86
3600	15.53	23.86	19.17	7.10	1.21	0.36	36.74	21.18	3600	5.78
3800	15.28	23.64	19.31	7.12	1.21	0.36	36.04	20.90	3800	5.91
4000	15.05	23.40	19.44	7.13	1.21	0.36	35.41	20.53	4000	5.96
4200	14.82	23.18	19.53	7.10	1.21	0.36	35.26	20.39	4200	6.26
4400	14.60	23.09	19.60	7.05	1.23	0.36	35.66	20.25	4400	6.08
4600	14.43	22.92	19.34	6.95	1.22	0.36	35.67	20.11	4600	6.09
4800	14.18	22.79	19.07	6.78	1.23	0.37	35.31	19.62	4800	6.00
5000	14.00	22.79	19.05	6.74	1.25	0.36	35.36	19.26	5000	6.20
5200	13.78	22.74	18.38	6.58	1.26	0.36	35.18	19.03	5200	6.36
5400	13.54	22.80	17.78	6.38	1.28	0.36	35.06	18.81	5400	6.48
5600	13.31	22.77	17.31	6.22	1.30	0.36	34.40	18.59	5600	6.44
5800	13.05	22.90	16.37	6.05	1.33	0.36	34.73	18.31	5800	6.38
6000	12.79	23.08	15.76	5.96	1.38	0.35	34.37	17.62	6000	6.52
6200	12.42	23.17	14.91	5.78	1.42	0.35	34.52	16.09	6500	6.53
6400	12.11	23.15	14.38	5.70	1.46	0.35	34.25	15.90	7000	6.99
6600	11.66	23.35	13.56	5.67	1.54	0.34	33.24	16.18	7500	7.21
6800	11.15	23.67	12.57	5.52	1.65	0.34	33.37	16.18	8000	7.64
7000	10.62	23.60	11.90	5.49	1.72	0.34	33.32	15.98	8500	8.28
7200	9.96	23.70	11.15	5.53	1.84	0.33	33.07	15.50	9000	8.77
7500	8.91	23.46	10.30	5.60	1.99	0.34	33.18	14.14	9500	9.34
8000	7.03	23.08	8.76	5.57	2.23	0.34	31.20	13.73	10000	9.56

Typical Performance Data

Definitions:

Input Return Loss = -S11 (dB)

Gain(Power Gain) = S21 (dB)

Reverse Isolation = -S12 (dB)

Output Return Loss = -S22 (dB)

TEST CONDITIONS: Vd = 5.00V, Icc=101mA @Temperature = -45degC

FREQ	Gain	Isolation	Input Return Loss	Output Return Loss	Stability		IP3 Output	1dB Comp. Output	FREQ	Noise Figure
(MHz)	(dB)	(dB)	(dB)	(dB)	K	Delta	(dBm)	(dBm)	(MHz)	(dB)
50	24.17	31.37	22.32	23.56	1.35	0.43	36.76	19.39	50	4.90
100	24.11	31.15	22.84	21.96	1.33	0.44	36.50	19.41	100	5.01
200	23.99	31.13	23.08	19.94	1.34	0.44	36.49	19.30	200	4.98
400	23.67	30.79	21.49	16.36	1.32	0.44	36.36	19.36	400	5.08
600	23.15	30.52	20.93	13.44	1.32	0.43	35.99	19.17	600	5.02
800	22.55	29.90	20.71	11.62	1.29	0.43	36.13	19.18	800	5.14
1000	21.91	29.37	20.36	10.36	1.28	0.43	36.46	19.22	1000	5.04
1200	21.25	28.87	19.68	9.48	1.27	0.42	36.54	18.88	1200	5.00
1400	20.59	28.31	19.21	8.73	1.25	0.42	36.67	19.02	1400	5.04
1600	19.94	27.79	18.94	8.20	1.24	0.42	37.31	19.16	1600	5.05
1800	19.34	27.29	18.60	7.78	1.23	0.41	37.73	19.24	1800	4.99
2000	18.80	26.70	18.70	7.49	1.21	0.41	38.26	19.40	2000	4.94
2200	18.24	26.41	18.73	7.33	1.23	0.40	38.29	19.58	2200	4.95
2400	17.78	25.90	18.84	7.13	1.21	0.40	38.07	19.66	2400	4.89
2600	17.30	25.65	19.43	7.12	1.23	0.39	37.47	19.69	2600	4.84
2800	16.92	25.28	19.60	7.02	1.23	0.38	37.70	19.85	2800	4.85
3000	16.63	24.68	19.64	6.89	1.18	0.39	37.38	20.22	3000	4.95
3200	16.29	24.43	20.43	6.97	1.20	0.38	37.43	20.37	3200	4.88
3400	16.02	24.09	20.21	6.88	1.18	0.38	37.62	20.40	3400	4.95
3600	15.81	23.68	19.90	6.84	1.16	0.39	37.41	20.43	3600	4.85
3800	15.51	23.46	20.01	6.92	1.17	0.39	36.56	20.23	3800	4.97
4000	15.37	23.28	20.45	6.98	1.17	0.38	35.80	19.98	4000	4.99
4200	15.13	23.00	20.39	6.88	1.16	0.39	36.17	19.87	4200	5.28
4400	14.92	22.95	20.25	6.74	1.17	0.39	36.46	19.68	4400	5.10
4600	14.73	22.72	20.59	6.46	1.15	0.39	36.45	19.62	4600	5.11
4800	14.55	22.58	20.02	6.30	1.15	0.39	36.00	19.37	4800	4.96
5000	14.39	22.63	20.69	6.19	1.17	0.39	35.66	19.14	5000	5.16
5200	14.19	22.56	20.00	6.03	1.17	0.39	35.48	18.89	5200	5.26
5400	14.03	22.53	19.47	5.82	1.17	0.39	35.29	18.59	5400	5.44
5600	13.88	22.54	19.79	5.64	1.18	0.40	34.56	18.50	5600	5.40
5800	13.70	22.45	18.19	5.53	1.19	0.40	34.26	18.32	5800	5.28
6000	13.52	22.67	17.12	5.34	1.21	0.39	33.90	17.83	6000	5.39
6200	13.28	22.71	16.17	5.19	1.23	0.39	33.52	16.40	6500	5.35
6400	12.98	22.68	14.77	5.01	1.24	0.40	33.34	16.11	7000	5.82
6600	12.57	22.97	13.69	4.93	1.30	0.39	33.51	16.20	7500	5.96
6800	12.10	23.34	12.59	4.61	1.37	0.39	33.35	16.16	8000	6.57
7000	11.66	23.12	11.85	4.57	1.39	0.40	32.94	16.10	8500	7.05
7200	11.02	23.45	11.11	4.53	1.50	0.38	31.91	15.79	9000	7.50
7500	10.01	23.03	10.47	4.59	1.60	0.39	30.91	14.51	9500	8.09
8000	8.22	22.47	9.01	4.74	1.77	0.38	30.99	14.58	10000	8.32

REV. X1
GVA-84+
110601
Page 4 of 9



IF/RF MICROWAVE COMPONENTS • ISO 9001 ISO 14001 AS 9100 CERTIFIED • RoHS compliant
P.O. Box 350166, Brooklyn, New York 11235-0003 (718) 934-4500 Fax (718) 332-4661



The Design Engineers Search Engine finds the model you need, Instantly • For detailed performance specs & shopping online see



Typical Performance Data

Definitions:

Input Return Loss = -S11 (dB)

Gain(Power Gain) = S21 (dB)

Reverse Isolation = -S12 (dB)

Output Return Loss = -S22 (dB)

TEST CONDITIONS: Vd = 4.75V, Icc=88mA @Temperature = -45degC

FREQ	Gain	Isolation	Input Return Loss	Output Return Loss	Stability		IP3 Output	1dB Comp. Output	FREQ	Noise Figure
(MHz)	(dB)	(dB)	(dB)	(dB)	K	Delta	(dBm)	(dBm)	(MHz)	(dB)
50	24.02	30.92	23.85	21.46	1.31	0.45	34.14	17.94	50	4.80
100	23.95	31.12	24.52	20.46	1.34	0.43	33.89	18.01	100	4.93
200	23.84	30.80	24.66	19.09	1.32	0.44	33.92	17.80	200	4.91
400	23.53	30.58	22.61	15.98	1.31	0.44	33.96	17.85	400	5.02
600	23.01	30.22	21.77	13.22	1.30	0.43	33.78	17.66	600	4.94
800	22.42	29.81	21.31	11.46	1.29	0.42	34.15	17.68	800	5.04
1000	21.78	29.22	20.84	10.24	1.27	0.42	34.52	17.74	1000	4.97
1200	21.12	28.70	19.95	9.37	1.26	0.42	34.65	17.32	1200	4.94
1400	20.46	28.14	19.38	8.61	1.24	0.42	34.89	17.51	1400	4.97
1600	19.82	27.58	19.00	8.11	1.23	0.42	35.66	17.66	1600	4.97
1800	19.22	27.14	18.61	7.69	1.22	0.41	36.11	17.81	1800	4.89
2000	18.67	26.61	18.64	7.40	1.21	0.41	36.54	18.00	2000	4.86
2200	18.12	26.16	18.62	7.24	1.21	0.40	36.85	18.21	2200	4.87
2400	17.66	25.82	18.65	7.04	1.21	0.39	36.74	18.42	2400	4.80
2600	17.19	25.54	19.23	7.03	1.22	0.38	35.70	18.38	2600	4.75
2800	16.81	25.17	19.34	6.94	1.22	0.38	35.73	18.57	2800	4.75
3000	16.51	24.57	19.31	6.81	1.17	0.38	35.70	18.94	3000	4.83
3200	16.18	24.33	20.11	6.89	1.19	0.38	35.65	18.97	3200	4.78
3400	15.90	24.00	19.86	6.81	1.18	0.38	35.76	19.08	3400	4.85
3600	15.69	23.59	19.55	6.75	1.15	0.39	35.44	19.27	3600	4.74
3800	15.40	23.41	19.65	6.84	1.17	0.38	34.92	19.00	3800	4.87
4000	15.25	23.22	20.04	6.90	1.16	0.38	34.01	18.73	4000	4.84
4200	15.01	22.98	20.01	6.81	1.16	0.38	34.39	18.72	4200	5.17
4400	14.79	22.87	19.91	6.69	1.17	0.38	34.48	18.55	4400	5.01
4600	14.61	22.70	20.21	6.40	1.15	0.39	34.24	18.48	4600	4.99
4800	14.43	22.55	19.72	6.26	1.15	0.39	33.89	18.18	4800	4.85
5000	14.26	22.58	20.38	6.16	1.17	0.38	33.68	17.98	5000	5.05
5200	14.05	22.54	19.71	6.01	1.18	0.39	33.09	17.75	5200	5.14
5400	13.88	22.46	19.21	5.80	1.18	0.39	32.93	17.41	5400	5.32
5600	13.73	22.53	19.55	5.65	1.19	0.39	32.45	17.27	5600	5.27
5800	13.54	22.43	17.98	5.54	1.20	0.40	31.97	17.15	5800	5.18
6000	13.35	22.64	16.94	5.36	1.22	0.39	31.69	16.70	6000	5.23
6200	13.11	22.68	16.01	5.24	1.24	0.39	31.29	15.73	6500	5.23
6400	12.80	22.67	14.68	5.06	1.26	0.40	31.10	15.43	7000	5.68
6600	12.39	22.94	13.61	4.98	1.33	0.38	31.02	15.52	7500	5.80
6800	11.92	23.35	12.54	4.67	1.39	0.38	30.65	15.48	8000	6.39
7000	11.47	23.10	11.83	4.64	1.42	0.39	30.33	15.44	8500	6.89
7200	10.83	23.44	11.06	4.59	1.53	0.38	29.63	15.10	9000	7.31
7500	9.82	22.99	10.46	4.68	1.63	0.38	29.44	13.78	9500	7.88
8000	8.04	22.46	8.99	4.80	1.80	0.38	29.03	14.01	10000	8.06

Typical Performance Data

Definitions:

Input Return Loss = -S11 (dB)

Gain(Power Gain) = S21 (dB)

Reverse Isolation = -S12 (dB)

Output Return Loss = -S22 (dB)

TEST CONDITIONS: Vd = 5.25V, Icc=115mA @Temperature = -45degC

FREQ	Gain	Isolation	Input Return Loss	Output Return Loss	Stability		IP3 Output	1dB Comp. Output	FREQ	Noise Figure
(MHz)	(dB)	(dB)	(dB)	(dB)	K	Delta	(dBm)	(dBm)	(MHz)	(dB)
50	24.29	32.49	21.09	24.75	1.46	0.38	38.90	20.00	50	5.01
100	24.22	31.58	21.78	23.25	1.36	0.42	38.62	20.05	100	5.15
200	24.10	31.61	21.86	20.71	1.38	0.42	38.54	19.96	200	5.08
400	23.78	31.01	20.69	16.62	1.33	0.43	38.26	20.05	400	5.21
600	23.25	30.61	20.29	13.58	1.32	0.43	37.67	19.85	600	5.12
800	22.65	30.10	20.21	11.72	1.30	0.43	37.62	19.87	800	5.23
1000	22.01	29.61	20.06	10.45	1.29	0.42	37.95	19.88	1000	5.15
1200	21.35	29.07	19.47	9.57	1.28	0.42	38.01	19.62	1200	5.13
1400	20.68	28.43	19.04	8.80	1.26	0.42	38.24	19.83	1400	5.15
1600	20.04	27.92	18.86	8.29	1.25	0.42	38.93	20.02	1600	5.15
1800	19.43	27.37	18.57	7.86	1.24	0.42	39.43	20.07	1800	5.08
2000	18.89	26.85	18.70	7.57	1.23	0.41	39.77	20.17	2000	5.05
2200	18.33	26.43	18.78	7.40	1.23	0.41	39.71	20.39	2200	5.05
2400	17.87	25.99	18.93	7.20	1.22	0.40	39.52	20.42	2400	4.99
2600	17.39	25.60	19.56	7.19	1.23	0.39	38.74	20.47	2600	4.96
2800	17.01	25.34	19.74	7.10	1.23	0.39	38.82	20.56	2800	4.98
3000	16.72	24.69	19.83	6.96	1.18	0.39	39.03	20.81	3000	5.04
3200	16.38	24.49	20.64	7.06	1.20	0.39	38.47	21.33	3200	5.00
3400	16.11	24.13	20.45	6.96	1.18	0.39	39.01	21.20	3400	5.09
3600	15.90	23.75	20.12	6.89	1.16	0.39	39.02	21.16	3600	4.94
3800	15.59	23.54	20.27	6.98	1.17	0.39	37.98	20.95	3800	5.06
4000	15.45	23.32	20.73	7.05	1.17	0.39	37.21	20.43	4000	5.09
4200	15.22	23.07	20.67	6.93	1.16	0.39	37.76	20.31	4200	5.40
4400	15.01	22.95	20.52	6.80	1.17	0.39	38.51	20.11	4400	5.22
4600	14.83	22.77	20.82	6.50	1.15	0.40	38.39	20.05	4600	5.22
4800	14.65	22.63	20.27	6.35	1.15	0.40	38.08	19.80	4800	5.09
5000	14.49	22.65	20.90	6.23	1.16	0.39	38.07	19.55	5000	5.28
5200	14.30	22.56	20.19	6.06	1.17	0.40	37.82	19.28	5200	5.41
5400	14.13	22.56	19.64	5.83	1.17	0.40	37.88	19.01	5400	5.58
5600	13.99	22.57	19.92	5.66	1.18	0.40	36.98	18.90	5600	5.55
5800	13.81	22.51	18.31	5.54	1.19	0.41	36.31	18.74	5800	5.43
6000	13.65	22.67	17.20	5.33	1.20	0.40	35.99	18.20	6000	5.49
6200	13.41	22.74	16.21	5.18	1.22	0.40	36.08	17.01	6500	5.51
6400	13.11	22.71	14.80	4.99	1.23	0.41	35.90	16.76	7000	5.98
6600	12.71	23.03	13.74	4.90	1.29	0.39	36.40	16.85	7500	6.12
6800	12.24	23.42	12.61	4.57	1.35	0.39	35.37	16.80	8000	6.71
7000	11.81	23.14	11.87	4.53	1.38	0.41	35.36	16.72	8500	7.23
7200	11.17	23.47	11.12	4.48	1.48	0.39	33.81	16.42	9000	7.64
7500	10.15	23.05	10.48	4.56	1.57	0.39	33.32	15.04	9500	8.29
8000	8.36	22.48	9.02	4.69	1.74	0.39	32.48	15.04	10000	8.52

Typical Performance Data

Definitions:

Input Return Loss = -S11 (dB)

Gain(Power Gain) = S21 (dB)

Reverse Isolation = -S12 (dB)

Output Return Loss = -S22 (dB)

TEST CONDITIONS: Vd = 5.00V, Icc=109mA @Temperature = +85degC

FREQ	Gain	Isolation	Input Return Loss	Output Return Loss	Stability		IP3 Output	1dB Comp. Output	FREQ	Noise Figure
(MHz)	(dB)	(dB)	(dB)	(dB)	K	Delta	(dBm)	(dBm)	(MHz)	(dB)
50	24.12	31.28	21.72	24.85	1.34	0.43	37.04	20.75	50	5.97
100	24.05	30.81	21.39	24.29	1.30	0.45	36.88	20.80	100	6.10
200	23.91	31.03	20.94	20.96	1.33	0.44	36.87	20.74	200	6.08
400	23.52	30.83	21.70	15.82	1.33	0.43	36.26	20.89	400	6.22
600	22.96	30.49	21.46	13.22	1.33	0.42	35.62	20.71	600	6.16
800	22.31	29.94	21.18	11.43	1.31	0.41	35.49	20.75	800	6.28
1000	21.63	29.41	20.77	10.24	1.30	0.41	35.54	20.78	1000	6.21
1200	20.93	28.80	20.36	9.36	1.29	0.41	35.32	20.63	1200	6.18
1400	20.24	28.32	19.77	8.69	1.28	0.40	35.10	20.61	1400	6.21
1600	19.58	27.77	19.34	8.19	1.27	0.39	35.39	20.75	1600	6.26
1800	18.94	27.28	18.77	7.82	1.27	0.39	35.40	20.70	1800	6.20
2000	18.38	26.76	18.41	7.53	1.25	0.38	35.28	20.82	2000	6.14
2200	17.80	26.38	18.20	7.41	1.26	0.37	34.93	20.90	2200	6.15
2400	17.31	25.95	17.94	7.27	1.26	0.36	34.63	20.92	2400	6.12
2600	16.85	25.53	17.90	7.25	1.25	0.36	34.42	20.94	2600	6.11
2800	16.42	25.14	17.95	7.25	1.25	0.35	34.51	21.03	2800	6.12
3000	16.06	24.71	17.57	7.11	1.23	0.35	34.24	20.98	3000	6.22
3200	15.69	24.47	17.82	7.21	1.25	0.34	34.01	20.77	3200	6.16
3400	15.40	24.17	17.73	7.21	1.24	0.34	33.98	20.58	3400	6.25
3600	15.13	23.83	17.68	7.18	1.23	0.34	33.71	20.49	3600	6.20
3800	14.83	23.61	17.92	7.31	1.25	0.34	33.10	20.16	3800	6.35
4000	14.62	23.40	17.96	7.39	1.26	0.33	32.49	19.71	4000	6.37
4200	14.35	23.18	18.20	7.41	1.27	0.34	32.67	19.55	4200	6.66
4400	14.13	23.11	18.12	7.41	1.29	0.33	32.42	19.42	4400	6.51
4600	13.89	22.88	17.84	7.29	1.29	0.34	32.26	19.18	4600	6.50
4800	13.62	22.81	17.40	7.20	1.30	0.34	32.00	18.62	4800	6.45
5000	13.38	22.88	17.12	7.14	1.34	0.33	32.07	18.22	5000	6.68
5200	13.13	22.95	16.59	7.08	1.38	0.33	31.51	18.01	5200	6.79
5400	12.79	22.92	15.86	6.90	1.41	0.33	31.07	17.75	5400	6.92
5600	12.51	22.98	15.70	6.83	1.45	0.32	30.88	17.57	5600	6.88
5800	12.19	23.08	15.03	6.74	1.50	0.32	30.62	17.29	5800	6.80
6000	11.82	23.32	14.46	6.67	1.58	0.31	30.29	16.60	6000	7.02
6200	11.42	23.46	14.08	6.58	1.66	0.30	30.42	14.82	6500	7.04
6400	10.97	23.57	13.63	6.53	1.75	0.30	29.79	14.87	7000	7.46
6600	10.48	23.81	13.21	6.51	1.88	0.29	29.54	15.14	7500	7.68
6800	9.94	24.19	12.27	6.36	2.04	0.28	29.74	15.14	8000	8.23
7000	9.38	23.71	11.82	6.54	2.08	0.29	29.38	14.76	8500	8.84
7200	8.73	24.18	10.86	6.46	2.29	0.29	29.13	14.27	9000	9.26
7500	7.66	23.98	10.07	6.57	2.50	0.29	29.09	12.99	9500	9.94
8000	5.76	23.12	8.75	6.59	2.70	0.29	28.51	12.11	10000	10.15

REV. X1
GVA-84+
110601
Page 7 of 9



IF/RF MICROWAVE COMPONENTS • ISO 9001 ISO 14001 AS 9100 CERTIFIED • RoHS compliant
P.O. Box 350166, Brooklyn, New York 11235-0003 (718) 934-4500 Fax (718) 332-4661



The Design Engineers Search Engine finds the model you need, Instantly • For detailed performance specs & shopping online see



Typical Performance Data

Definitions:

Input Return Loss = -S11 (dB)

Gain(Power Gain) = S21 (dB)

Reverse Isolation = -S12 (dB)

Output Return Loss = -S22 (dB)

TEST CONDITIONS: Vd = 4.75V, Icc=94mA @Temperature = +85degC

FREQ	Gain	Isolation	Input Return Loss	Output Return Loss	Stability		IP3 Output	1dB Comp. Output	FREQ	Noise Figure
(MHz)	(dB)	(dB)	(dB)	(dB)	K	Delta	(dBm)	(dBm)	(MHz)	(dB)
50	23.93	31.24	24.08	22.20	1.36	0.43	34.63	19.79	50	5.83
100	23.87	30.74	23.17	22.26	1.31	0.45	34.49	19.81	100	5.97
200	23.72	30.90	22.46	20.02	1.34	0.43	34.55	19.76	200	5.97
400	23.35	30.43	23.05	15.47	1.31	0.44	34.11	19.84	400	6.09
600	22.80	30.17	22.42	13.01	1.31	0.42	33.73	19.69	600	6.05
800	22.16	29.64	21.79	11.29	1.29	0.42	33.89	19.72	800	6.17
1000	21.48	29.13	21.15	10.14	1.28	0.41	34.04	19.78	1000	6.09
1200	20.79	28.68	20.55	9.26	1.28	0.40	33.93	19.55	1200	6.07
1400	20.11	28.02	19.82	8.60	1.26	0.40	33.81	19.58	1400	6.10
1600	19.45	27.55	19.27	8.11	1.25	0.39	34.25	19.74	1600	6.13
1800	18.82	27.08	18.64	7.72	1.25	0.38	34.36	19.73	1800	6.08
2000	18.26	26.63	18.20	7.45	1.24	0.38	34.35	19.86	2000	6.01
2200	17.69	26.19	17.97	7.32	1.24	0.37	34.10	19.98	2200	6.05
2400	17.19	25.77	17.68	7.19	1.24	0.36	33.87	20.02	2400	5.99
2600	16.73	25.45	17.61	7.18	1.25	0.35	33.18	20.04	2600	6.00
2800	16.31	25.08	17.64	7.17	1.25	0.35	33.19	20.16	2800	6.01
3000	15.95	24.62	17.24	7.03	1.22	0.34	33.10	20.10	3000	6.09
3200	15.58	24.39	17.47	7.13	1.24	0.34	32.93	19.94	3200	6.03
3400	15.29	24.07	17.36	7.14	1.24	0.33	33.02	19.81	3400	6.10
3600	15.01	23.72	17.30	7.12	1.22	0.33	32.68	19.76	3600	6.05
3800	14.71	23.53	17.58	7.24	1.25	0.33	31.94	19.45	3800	6.22
4000	14.51	23.32	17.61	7.34	1.25	0.33	31.46	19.00	4000	6.23
4200	14.23	23.18	17.85	7.37	1.27	0.33	31.64	18.90	4200	6.50
4400	14.01	23.04	17.78	7.39	1.29	0.33	31.59	18.72	4400	6.33
4600	13.77	22.82	17.54	7.27	1.29	0.34	31.31	18.51	4600	6.36
4800	13.49	22.80	17.12	7.19	1.31	0.33	31.01	17.92	4800	6.31
5000	13.25	22.87	16.89	7.15	1.35	0.33	30.79	17.55	5000	6.51
5200	12.98	22.93	16.35	7.09	1.39	0.32	30.62	17.38	5200	6.64
5400	12.65	22.93	15.69	6.93	1.43	0.32	30.14	17.07	5400	6.75
5600	12.37	22.98	15.52	6.88	1.47	0.32	29.92	16.82	5600	6.71
5800	12.04	23.08	14.86	6.80	1.52	0.31	29.63	16.52	5800	6.66
6000	11.66	23.35	14.36	6.75	1.61	0.30	29.40	15.86	6000	6.83
6200	11.26	23.45	13.98	6.67	1.69	0.29	29.89	14.32	6500	6.83
6400	10.80	23.59	13.56	6.61	1.79	0.29	29.39	14.37	7000	7.30
6600	10.32	23.79	13.14	6.61	1.92	0.28	29.41	14.67	7500	7.45
6800	9.78	24.24	12.24	6.46	2.09	0.28	29.09	14.67	8000	8.00
7000	9.21	23.73	11.78	6.64	2.13	0.29	28.67	14.48	8500	8.63
7200	8.57	24.20	10.85	6.56	2.35	0.28	28.25	14.00	9000	9.07
7500	7.50	23.94	10.06	6.67	2.54	0.28	28.61	12.75	9500	9.73
8000	5.62	23.08	8.73	6.69	2.74	0.29	27.75	11.74	10000	9.87

Typical Performance Data

Definitions:

Input Return Loss = -S11 (dB)

Gain(Power Gain) = S21 (dB)

Reverse Isolation = -S12 (dB)

Output Return Loss = -S22 (dB)

TEST CONDITIONS: Vd = 5.25V, Icc=125mA @Temperature = +85degC

FREQ	Gain	Isolation	Input Return Loss	Output Return Loss	Stability		IP3 Output	1dB Comp. Output	FREQ	Noise Figure
(MHz)	(dB)	(dB)	(dB)	(dB)	K	Delta	(dBm)	(dBm)	(MHz)	(dB)
50	24.25	30.88	20.42	27.05	1.29	0.46	39.10	21.50	50	6.08
100	24.18	31.29	20.47	26.23	1.34	0.44	39.01	21.53	100	6.22
200	24.02	31.27	19.93	21.51	1.35	0.43	38.87	21.49	200	6.20
400	23.65	30.91	20.74	16.05	1.33	0.43	38.03	21.65	400	6.34
600	23.06	30.53	20.80	13.39	1.33	0.42	37.13	21.48	600	6.29
800	22.42	30.10	20.70	11.53	1.32	0.41	36.70	21.50	800	6.39
1000	21.73	29.61	20.48	10.35	1.32	0.41	36.65	21.50	1000	6.34
1200	21.03	28.92	20.22	9.43	1.29	0.41	36.30	21.36	1200	6.32
1400	20.34	28.47	19.71	8.76	1.29	0.40	36.03	21.36	1400	6.37
1600	19.66	27.89	19.33	8.27	1.28	0.39	36.15	21.42	1600	6.39
1800	19.04	27.41	18.85	7.89	1.28	0.39	36.12	21.36	1800	6.34
2000	18.45	26.83	18.52	7.61	1.26	0.38	35.97	21.51	2000	6.26
2200	17.89	26.42	18.31	7.47	1.26	0.38	35.52	21.58	2200	6.29
2400	17.39	25.94	18.10	7.34	1.25	0.37	35.13	21.54	2400	6.25
2600	16.94	25.53	18.12	7.32	1.25	0.36	34.90	21.62	2600	6.25
2800	16.50	25.29	18.15	7.33	1.27	0.35	34.92	21.66	2800	6.27
3000	16.15	24.78	17.78	7.19	1.24	0.35	34.65	21.61	3000	6.38
3200	15.77	24.58	18.05	7.27	1.26	0.34	34.26	21.31	3200	6.31
3400	15.47	24.15	17.96	7.27	1.24	0.34	34.32	21.10	3400	6.41
3600	15.21	23.91	17.86	7.24	1.24	0.34	34.10	20.99	3600	6.34
3800	14.90	23.68	18.14	7.37	1.26	0.34	33.49	20.62	3800	6.51
4000	14.69	23.44	18.19	7.45	1.26	0.34	32.79	20.16	4000	6.55
4200	14.42	23.24	18.43	7.46	1.27	0.34	32.81	19.99	4200	6.80
4400	14.21	23.12	18.31	7.45	1.28	0.34	32.84	19.84	4400	6.65
4600	13.97	22.92	18.00	7.32	1.28	0.34	32.48	19.61	4600	6.67
4800	13.70	22.80	17.54	7.22	1.30	0.34	32.18	19.05	4800	6.61
5000	13.47	22.89	17.25	7.16	1.33	0.34	31.98	18.65	5000	6.84
5200	13.21	22.97	16.71	7.09	1.37	0.33	31.69	18.44	5200	6.99
5400	12.88	22.94	15.94	6.90	1.40	0.33	31.26	18.23	5400	7.10
5600	12.62	22.97	15.78	6.81	1.44	0.33	30.91	18.02	5600	7.07
5800	12.29	23.09	15.08	6.72	1.49	0.32	30.69	17.67	5800	7.00
6000	11.92	23.33	14.50	6.65	1.57	0.31	30.72	17.00	6000	7.21
6200	11.52	23.43	14.10	6.54	1.64	0.31	30.31	15.30	6500	7.22
6400	11.07	23.60	13.65	6.48	1.74	0.30	30.18	15.34	7000	7.69
6600	10.58	23.82	13.21	6.47	1.86	0.29	29.72	15.61	7500	7.91
6800	10.05	24.22	12.26	6.31	2.02	0.29	29.41	15.48	8000	8.46
7000	9.48	23.75	11.81	6.50	2.06	0.30	29.23	14.98	8500	9.09
7200	8.82	24.23	10.86	6.40	2.28	0.29	29.27	14.48	9000	9.51
7500	7.76	23.95	10.07	6.52	2.46	0.29	29.28	13.16	9500	10.19
8000	5.85	23.16	8.74	6.55	2.68	0.29	28.10	12.37	10000	10.47

Typical Performance Curves

GAIN vs. FREQUENCY & TEMPERATURE

INPUT POWER = -25dBm, Vd = 5.00V

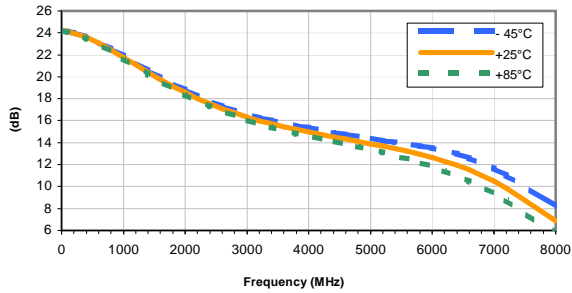

GAIN vs. DEVICE VOLTAGE

INPUT POWER = -25dBm, Temperature = +25°C

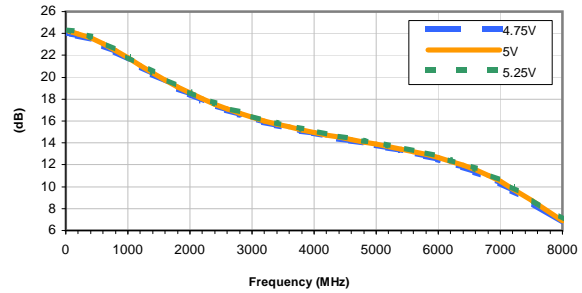

ISOLATION vs. FREQUENCY & TEMPERATURE

INPUT POWER = -25dBm, Vd = 5.00V

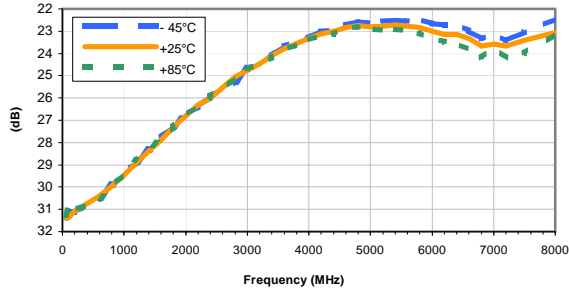

ISOLATION vs. DEVICE VOLTAGE

INPUT POWER = -25dBm, Temperature = +25°C

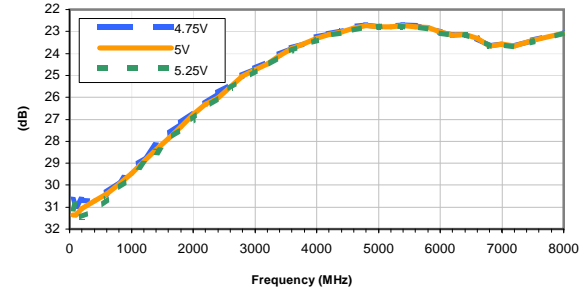

INPUT RETURN LOSS vs. FREQUENCY & TEMPERATURE

INPUT POWER = -25dBm, Vd = 5.00V
106mA

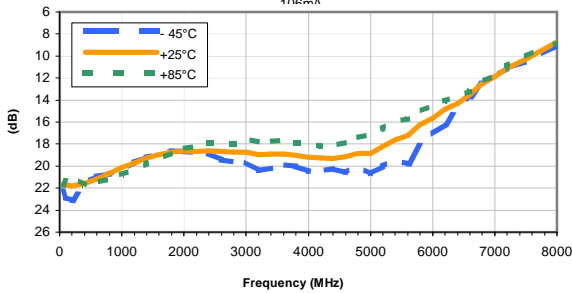

INPUT RETURN LOSS vs. DEVICE VOLTAGE

INPUT POWER = -25dBm, Temperature = +25°C

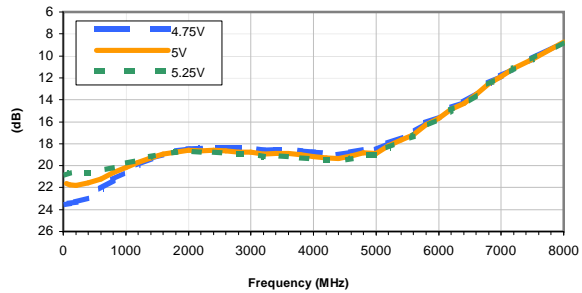

OUTPUT RETURN LOSS vs. FREQUENCY & TEMPERATURE

INPUT POWER = -25dBm, Vd = 5.00V

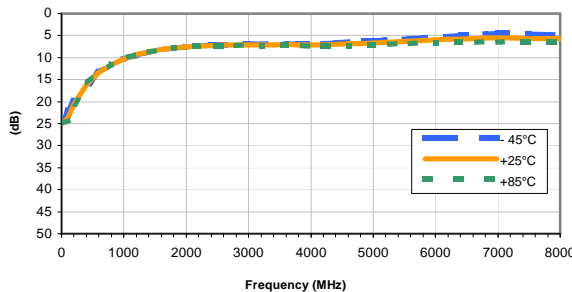

OUTPUT RETURN LOSS vs. DEVICE VOLTAGE

INPUT POWER = -25dBm, Temperature = +25°C

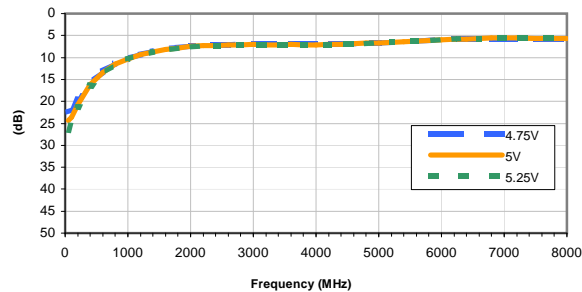

IF/RF MICROWAVE COMPONENTS • ISO 9001 ISO 14001 AS 9100 CERTIFIED • RoHS compliant
P.O. Box 350166, Brooklyn, New York 11235-0003 (718) 934-4500 Fax (718) 332-4661



The Design Engineers Search Engine finds the model you need, Instantly • For detailed performance specs & shopping online see



Typical Performance Curves

OUTPUT IP3 vs. FREQUENCY & TEMPERATURE

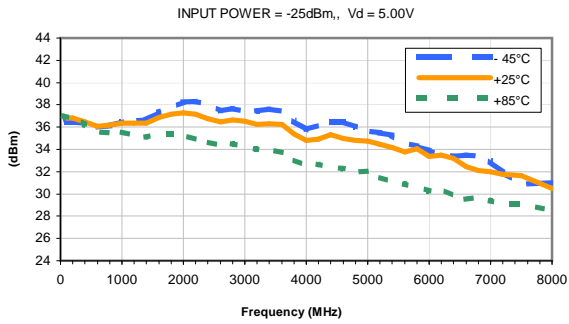

OUTPUT IP-3 vs. DEVICE VOLTAGE

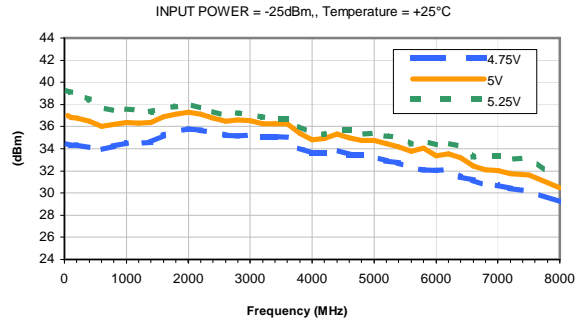

OUTPUT POWER at 1dB Compression vs. FREQUENCY & TEMPERATURE

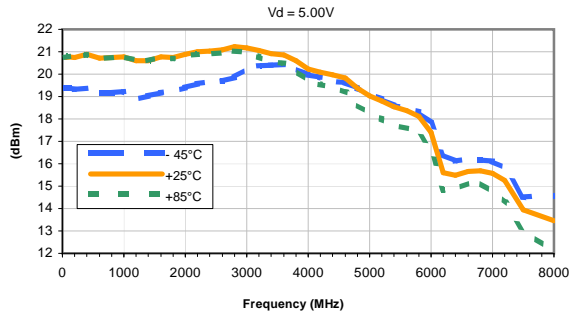

OUTPUT POWER at 1dB Compression vs. DEVICE VOLTAGE

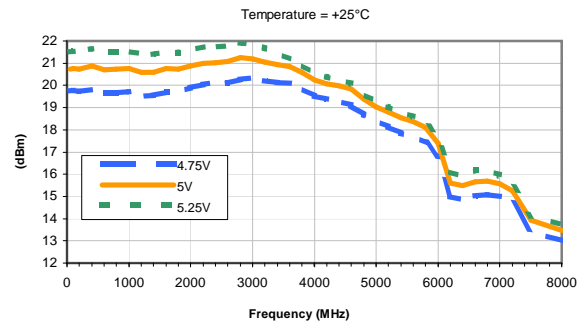

Noise Figure vs. FREQUENCY & TEMPERATURE

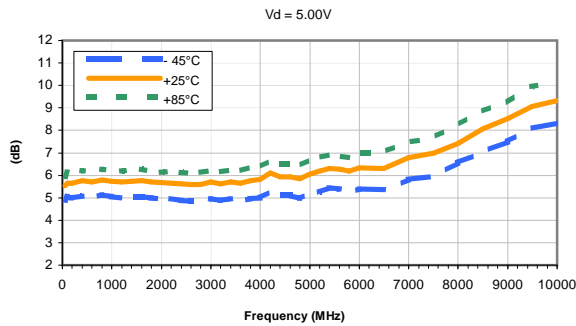

Noise Figure vs. DEVICE VOLTAGE

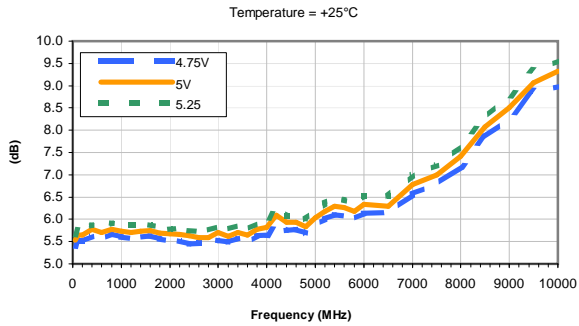

Outline Dimensions

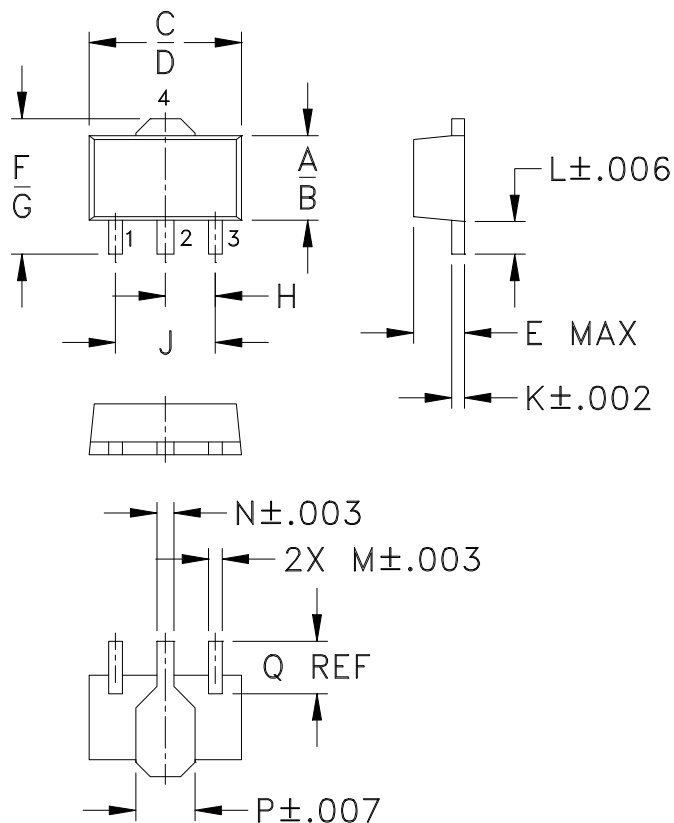

PCB Land Pattern

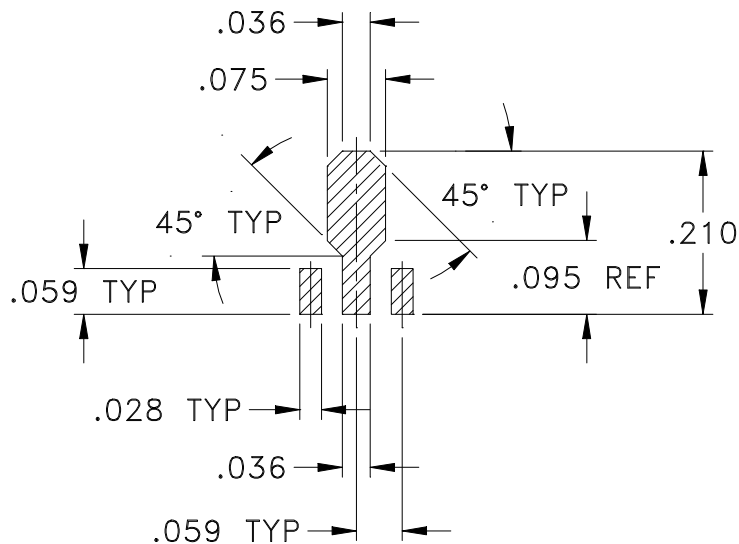

Suggested Layout,
Tolerance to be within $\pm .002$

CASE #	A	B	C	D	E	F	G	H	J	K	L	M
DF782	.102 (2.59)	.090 (2.29)	.181 (4.60)	.173 (4.39)	.063 (1.60)	.167 (4.24)	.155 (3.94)	.059 (1.50)	.118 (3.00)	.015 (0.38)	.041 (1.04)	.016 (0.41)

CASE #	N	P	Q	WT. GRAM
DF782	.019 (0.48)	.065 (1.65)	.062 (1.57)	.2

Dimensions are in inches (mm). Tolerances: 2 Pl. $\pm .01$; 3Pl. $\pm .005$

Notes:

- Case material: Plastic.
- Termination finish:
 For RoHS Case Styles: Tin-Silver alloy plate over Nickel barrier or Matte-Tin.
 All models, (+) suffix. See model Data sheet.
 For RoHS-5 Case Styles: Tin-Lead plate. All models, no (+) suffix.



INTERNET <http://www.minicircuits.com>

P.O. Box 350166, Brooklyn, New York 11235-0003 (718) 934-4500 Fax (718) 332-4661

Distribution Centers NORTH AMERICA 800-654-7949 • 417-335-5935 • Fax 417-335-5945 • EUROPE 44-1252-832600 • Fax 44-1252-837010

Mini-Circuits ISO 9001 & ISO 14001 Certified

Tape & Reel Packaging TR-F55

DEVICE ORIENTATION IN T&R

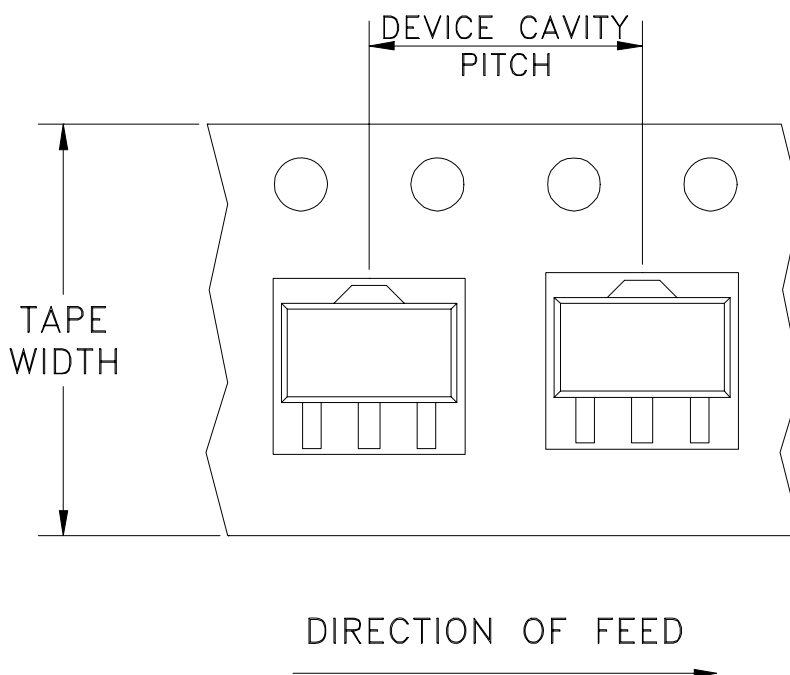

Tape Width, mm	Device Cavity Pitch, mm	Reel Size, inches	Devices per Reel	
12	8	7	Small quantity standard (see note)	20
				50
				100
				200
				500
			Standard	1000

Note: Please consult individual model data sheet to determine device per reel availability.

Mini-Circuits carrier tape materials provide protection from ESD (Electro-Static Discharge) during handling and transportation. Tapes are static dissipative and comply with industry standards EIA-481/EIA-541.

Go to: www.minicircuits.com/pages/pdfs/tape.pdf



INTERNET <http://www.minicircuits.com>

P.O. Box 350166, Brooklyn, New York 11235-0003 (718) 934-4500 Fax (718) 332-4661

Distribution Centers NORTH AMERICA 800-654-7949 • 417-335-5935 • Fax 417-335-5945 • EUROPE 44-1252-832600 • Fax 44-1252-837010

Mini-Circuits ISO 9001 & ISO 14001 Certified

THIRD ANGLE PROJECTION

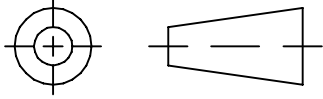

REVISIONS

REV	ECN No.	DESCRIPTION	DATE	DR	AUTH
OR	M108433	NEW RELEASE	11/14/06	PW	IG
A	M124803	"04AM03" WAS "mz", MODIFIED TB IN TITLE	10/23/09	MMG	DJ

SUGGESTED MOUNTING CONFIGURATION
FOR DF782 CASE STYLE, "04AM03" PIN CONNECTION

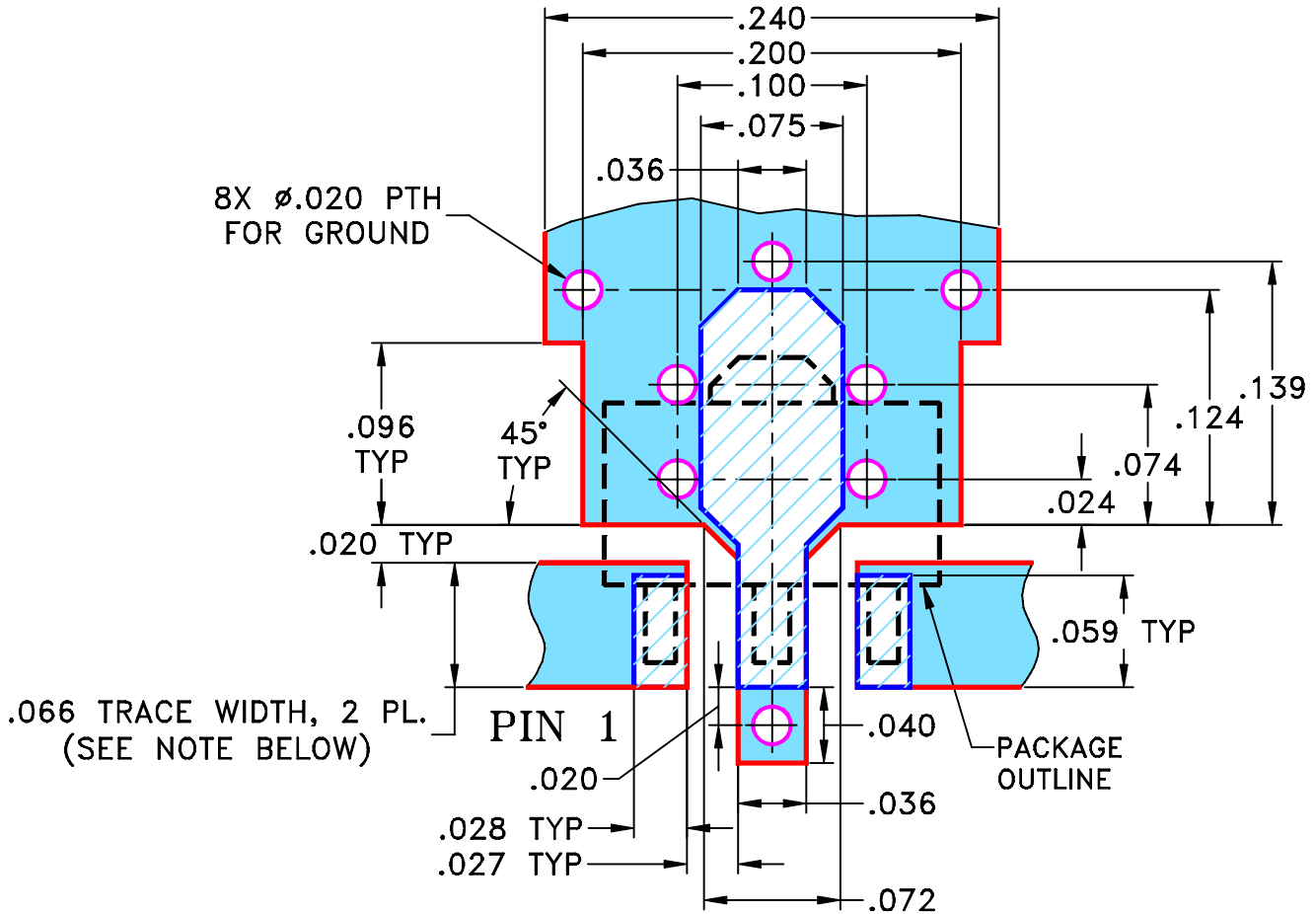

- NOTES:** 1. TRACE WIDTH IS SHOWN FOR ROGERS RO4350B WITH DIELECTRIC THICKNESS .030" ± .002"; COPPER: 1/2 OZ. EACH SIDE. FOR OTHER MATERIALS TRACE WIDTH MAY NEED TO BE MODIFIED.
2. BOTTOM SIDE OF THE PCB IS CONTINUOUS GROUND PLANE.



DENOTES PCB COPPER LAYOUT WITH SMOBC (SOLDER MASK OVER BARE COPPER)



DENOTES COPPER LAND PATTERN FREE OF SOLDER MASK

UNLESS OTHERWISE SPECIFIED	INITIALS	DATE
DIMENSIONS ARE IN INCHES	DRAWN PW	11/14/06
TOLERANCES ON:	CHECKED IL	11/14/06
2 PL DECIMALS ±	APPROVED IG	11/14/06
3 PL DECIMALS ± .005		
ANGLES ±		
FRACTIONS ±		



Mini-Circuits® 13 Neptune Avenue
Brooklyn NY 11235

PL, 04AM03, DF782, GVA, TB-410-XX+

Mini-Circuits®
THIS DOCUMENT AND ITS CONTENTS ARE THE PROPERTY OF MINI-CIRCUITS. EXCEPT FOR USE EXPRESSLY GRANTED, IN WRITING, TO ITS VENDORS, VEECE AND THE UNITED STATES GOVERNMENT, MINI-CIRCUITS RESERVES ALL PROPRIETARY DESIGN, USE, MANUFACTURING AND REPRODUCTION RIGHTS THERETO. THESE CONTENTS SHALL NOT BE USED, DUPLICATED OR DISCLOSED TO ANY OUTSIDE PARTY, IN WHOLE OR IN PART, WITHOUT WRITTEN PERMISSION OF MINI-CIRCUITS.

SIZE	CODE IDENT	DRAWING NO:	REV:
A	15542	98-PL-255	A
FILE:	98PL255	SCALE: 10:1	SHEET: 1 OF 1

Evaluation Board and Circuit

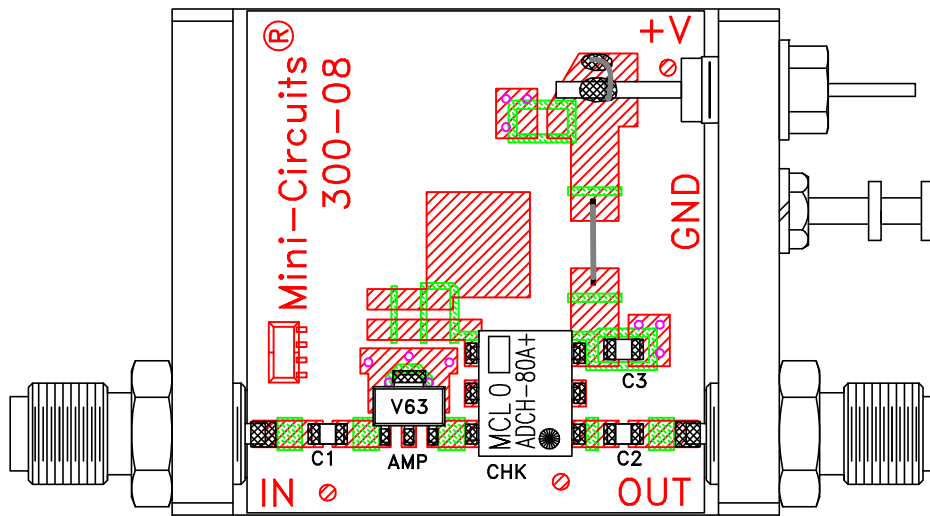

TB-410-84+

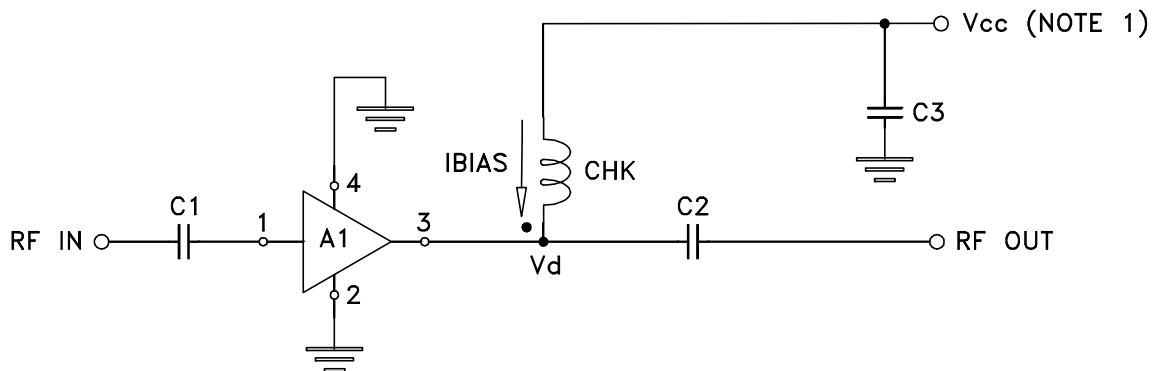

COMPONENT	VALUE
A1	GVA-84+
C1 (NOTE 4)	2400 pF
C2 (NOTE 4)	2400 pF
C3 (bypass)	0.1 uF
CHK	Mini-Circuits ADCH-80A+

Schematic Diagram

- NOTE:**
1. Vcc voltage: $+5 \pm 0.2V$.
 2. SMA Female connectors.
 3. PCB material: Rogers R04350 or equivalent, dielectric constant=3.5, dielectric thickness=.030 inch.
 4. Capacitors, C1 & C2 should be free of resonance up to the highest frequency specified.

 **Mini-Circuits®**

All Mini-Circuits products are manufactured under exacting quality assurance and control standards, and are capable of meeting published specifications after being subjected to any or all of the following physical and environmental test.

Specification	Test/Inspection Condition	Reference/Spec
Operating Temperature	-40° to 85°C Ambient Environment	Individual Model Data Sheet
Storage Temperature	-55° to 100° C or -65° to 150° Ambient Environment	Individual Model Data Sheet
Thermal Shock	-55° to 100°C, 100 cycles	MIL-STD-202, Method 107, Condition A-3, except +100°C
Mechanical Shock	1.5Kg, 0.5 ms, 5 shock pulses, Y1 direction only	MIL-STD-883, Method 2002, Condition B, except Y1 direction only
Vibration (Variable Frequency)	50g peak	MIL-STD-883, Method 2007, Condition B
Autoclave	15 psig, 100% RH, 121°C, 96 hours	JESD22-A102, Condition C
HAST	130°C, 85% RH, 96 hours	JESD22-A110
Solderability	10X Magnification	J-STD-002, Para 4.2.5, Test S, 95% Coverage
Solder Reflow Heat	Sn-Pb Eutetic Process: 240°C peak Pb-Free Process: 260°C peak	J-STD-020, Table 4-1, 4-2 and 5-2; Figure 5-1
Moisture Sensitivity: Level 1	Bake at 125°C for 24 hours Soak at 85°C/85% RH for 168 hours, Reflow 3 cycles at 260°C peak	J-STD-020
Marking Resistance to Solvents	Isopropyl alcohol + mineral spirits at 25°C; terpene defluxer at 25°C; distilled water + proylene glycol monomethyl ether +	MIL-STD-202, Method 215



All Mini-Circuits products are manufactured under exacting quality assurance and control standards, and are capable of meeting published specifications after being subjected to any or all of the following physical and environmental test.

Specification	Test/Inspection Condition	Reference/Spec
---------------	---------------------------	----------------

monoethanolamine at 63°C to 70°C