

The RF Line  
**PCS Band**  
**RF Power LDMOS Amplifiers**

**MHW1810-1**  
**MHW1810-2**

**1805–1880 MHz, 10 W**  
**RF POWER LDMOS AMPLIFIERS**

- Specified 26 Volts, 1805–1880 MHz, Class AB Characteristics  
Output Power = 16 Watts CW Typ  
Power Gain = 26 dB Typ @ 10 Watts (MHW1810-1)  
Power Gain = 34 dB Typ @ 10 Watts (MHW1810-2)  
Efficiency = 34% Min @ 10 Watts
- 50 Ω Input/Output System
- Designed for GSM Linearity Requirements

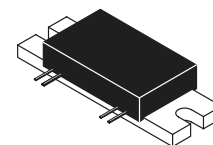

CASE 301AW-02, STYLE 1

**MAXIMUM RATINGS**

Rating	Symbol	Value	Unit
DC Supply Voltage	$V_S$	28	Vdc
DC Bias Voltage	$V_{bias}$	28	Vdc
RF Input Power	$P_{in}$	MHW1810-1: 21 MHW1810-2: 16	dBm
RF Output Power	$P_{out}$	20	W
Operating Case Temperature Range	$T_C$	-10 to +90	°C
Storage Temperature Range	$T_{stg}$	-30 to +100	°C

**ELECTRICAL CHARACTERISTICS** ( $T_C = +25^\circ\text{C}$ ,  $V_S = 26\text{ Vdc}$ ;  $V_{bias} = 5\text{ Vdc}$ ; 50 Ω system, unless otherwise noted)

Characteristic	Symbol	Min	Typ	Max	Unit
Frequency Range	BW	1805	—	1880	MHz
Quiescent Current ( $P_{in} = 0\text{ mW}$ )	$I_{DQ}$	100	—	150	mA
Bias Current	$I_{bias}$	—	—	2	mA
Output Power at 1 dB Compression	$P_{1dB}$	10	14	—	W
Power Gain ( $P_{out} = 10\text{ W}$ ) ( $P_{out} = 10\text{ W}$ )	$G_p$	MHW1810-1: 24 MHW1810-2: 32	26 34	28 36	dB
Efficiency ( $P_{out} = 10\text{ W}$ )	$\eta$	34	—	—	%
Input VSWR ( $P_{out} = 10\text{ W}$ )	VSWR <sub>in</sub>	—	—	1.8:1	—
Harmonics at $2f_o$ ( $P_{out} = 10\text{ W}$ )	$H_2$	—	—	-35	dBc
Harmonics at $3f_o$ ( $P_{out} = 10\text{ W}$ )	$H_3$	—	—	-45	dBc
Reverse IMD; $P_{out} = 10\text{ W}$ ; Preverse = -40 dBc ( $F1 = F0 \pm 200\text{ kHz}$ @ -40 dBc)	IMD <sub>r</sub>	—	—	-50	dBc
Load Mismatch Stress Load VSWR = 5:1, All Phase Angles	$\psi$	No Degradation in Output Power			
Stability ( $P_{out} = 10\text{ mW}$ to $10\text{ W}$ , $V_S \leq 26\text{ Vdc}$ ) Load VSWR = 5:1, All Phase Angles	—	All Spurious Outputs More Than 60 dB Below Desired Signal			

NOTE – **CAUTION** – MOS devices are susceptible to damage from electrostatic charge. Reasonable precautions in handling and packaging MOS devices should be observed.

**EXTREME CASE ELECTRICAL CHARACTERISTICS** ( $T_C = -10$  to  $+85^\circ\text{C}$ ,  $V_S = 23.5$  to  $26$  Vdc,  $V_{\text{bias}} = 3$  to  $26$  Vdc,  $50\ \Omega$  system, unless otherwise noted)

Characteristic	Symbol	Min	Typ	Max	Unit
Frequency Range	BW	1805	—	1880	MHz
Quiescent Current ( $P_{\text{in}} = 0$ mW)	$I_{\text{DQ}}$	100	—	160	mA
Bias Current	$I_{\text{bias}}$	—	—	2	mA
Output Power at 1 dB Compression	$P_{1\text{dB}}$	8	—	—	W
Power Gain Variation for a Given Part ( $P_{\text{out}} = 10$ W)	$G_p$	—	5	6.5	dB
Efficiency ( $P_{\text{out}} = 10$ W)	$\eta$	32	—	—	%
Input VSWR	$\text{VSWR}_{\text{in}}$	—	—	2:1	—
Harmonics at $2f_o$	$H_2$	—	—	-35	dBc
Harmonics at $3f_o$	$H_3$	—	—	-45	dBc
Reverse IMD; $P_{\text{out}} = 10$ W; Preverse = -40 dBc ( $F1 = F0 \pm 200$ kHz @ -40 dBc)	$\text{IMD}_r$	—	—	-50	dBc
Load Mismatch Stress Load VSWR = 5:1, All Phase Angles	$\psi$	No Degradation in Output Power			
Stability ( $P_{\text{out}} = 10$ mW to 10 W, $V_S \leq 26$ Vdc) Load VSWR = 5:1, All Phase Angles	—	All Spurious Outputs More Than 60 dB Below Desired Signal			

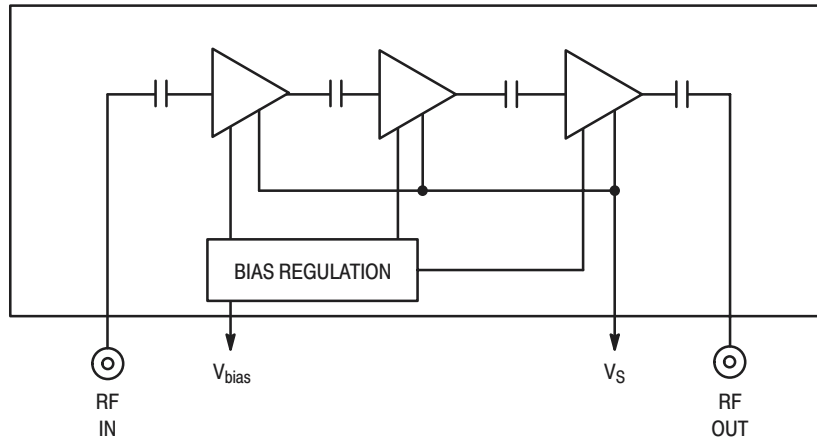

Figure 1. Internal Diagram

TYPICAL CHARACTERISTICS  
MHW1810-1

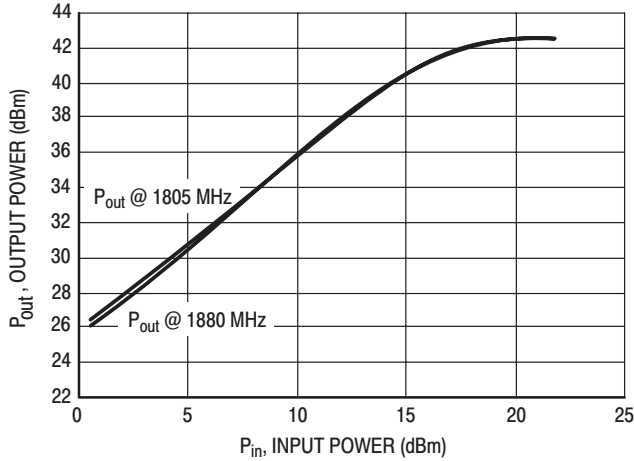

Figure 2. Output Power versus Input Power

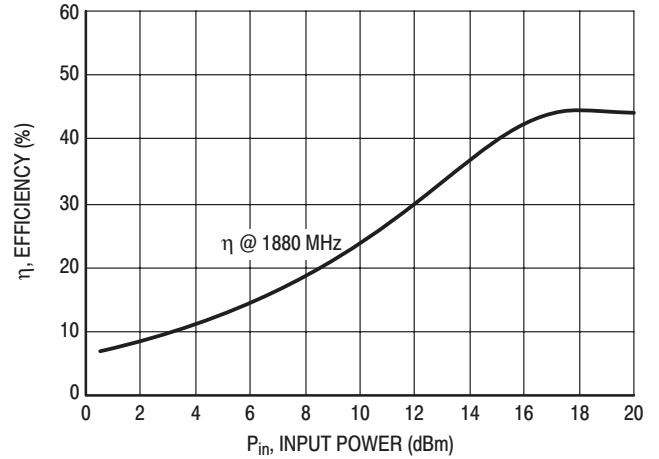

Figure 3. Efficiency versus Input Power

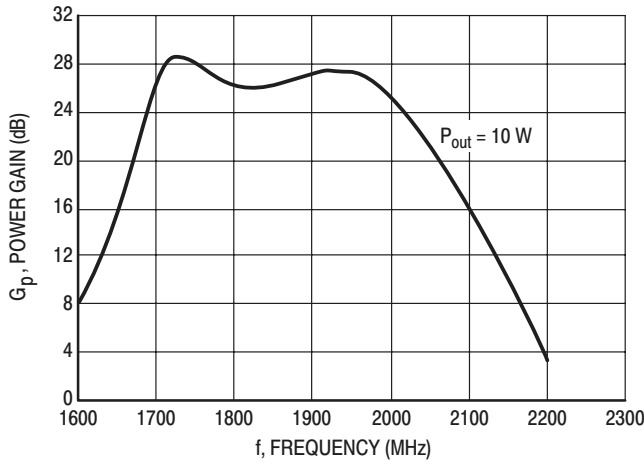

Figure 4. Power Gain versus Frequency

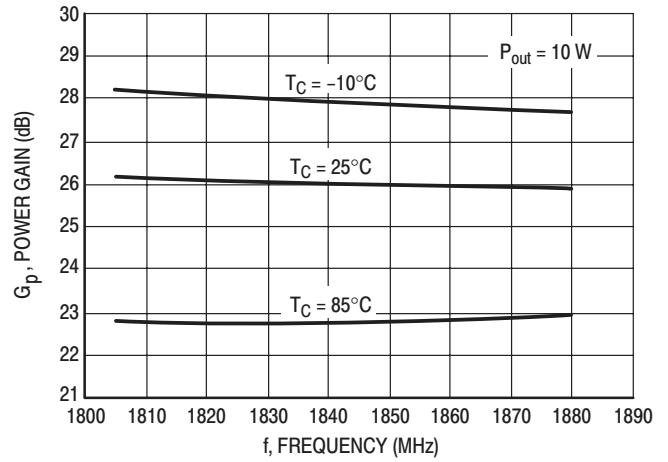

Figure 5. Gain versus Frequency

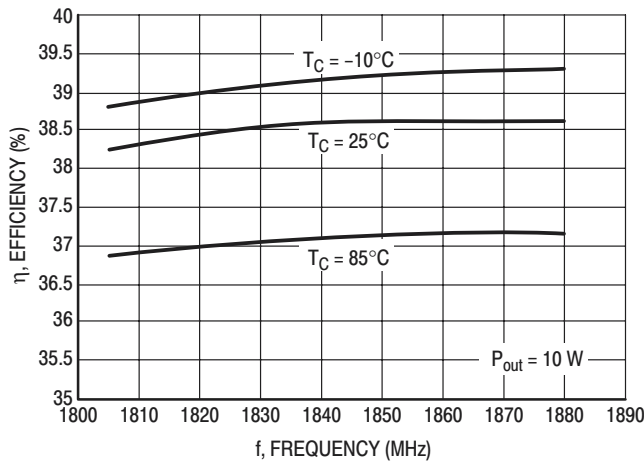

Figure 6. Efficiency versus Frequency

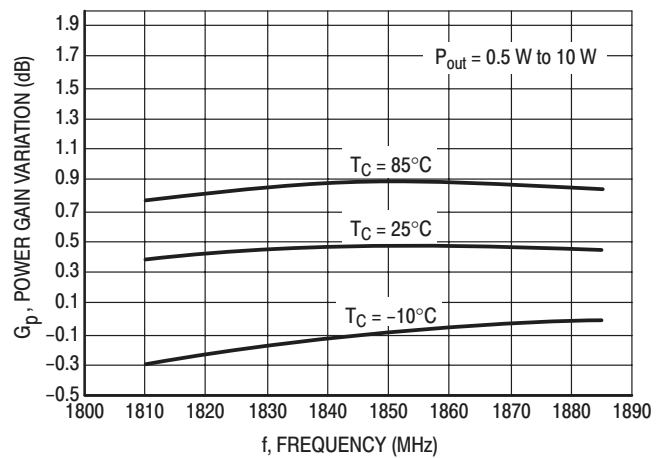

Figure 7. Power Gain Variation versus Frequency

ARCHIVE INFORMATION

ARCHIVE INFORMATION

TYPICAL CHARACTERISTICS  
MHW1810-1

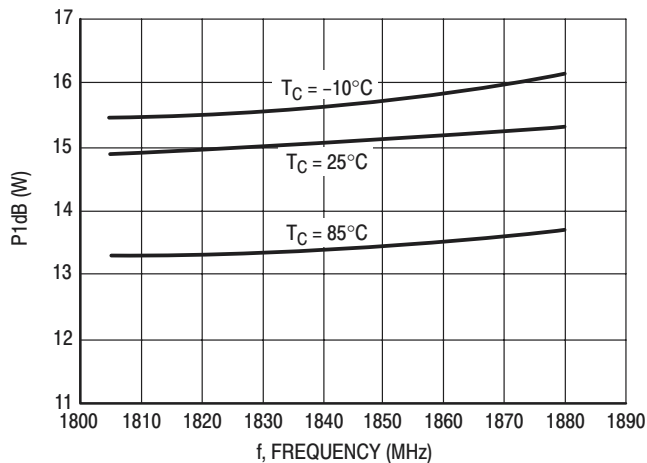

Figure 8. P1dB versus Frequency

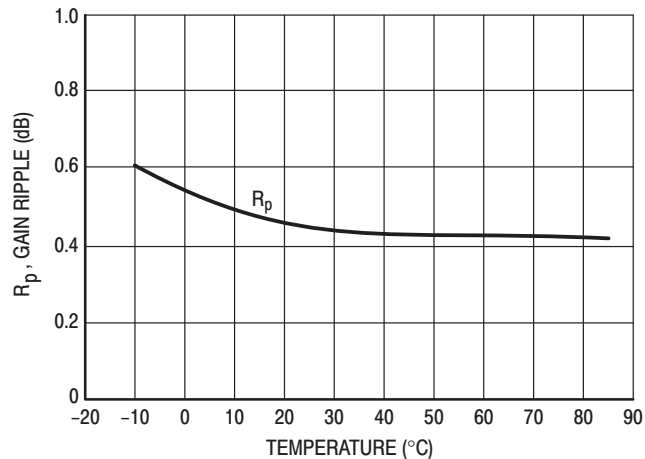

Figure 9. Gain Ripple versus Temperature

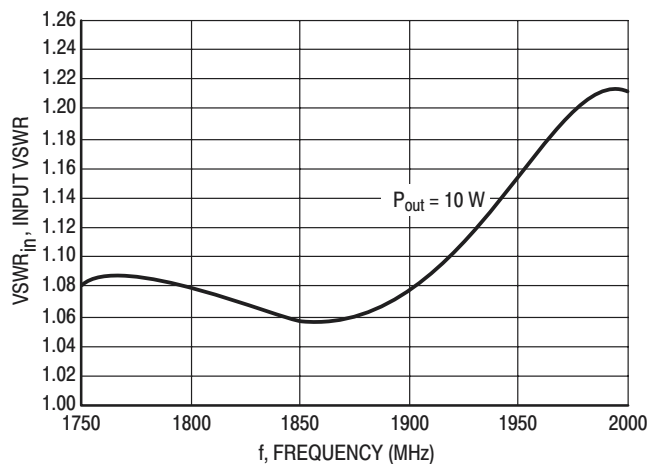

Figure 10. Input VSWR

ARCHIVE INFORMATION

ARCHIVE INFORMATION

TYPICAL CHARACTERISTICS  
MHW1810-2

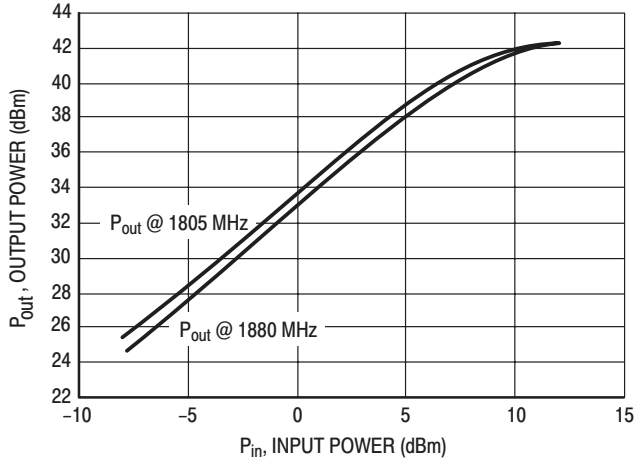

Figure 11. Output Power versus Input Power

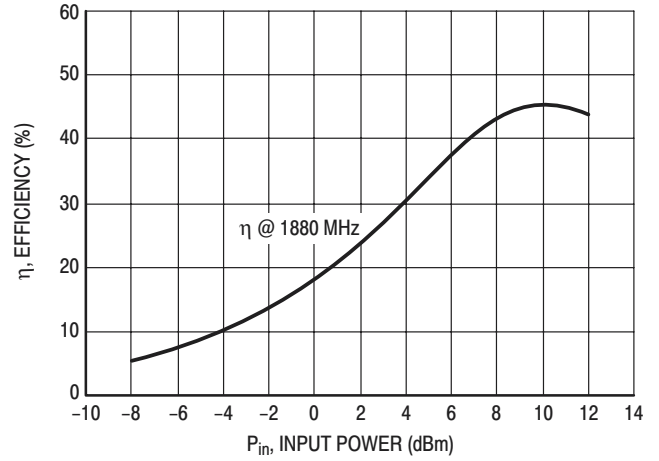

Figure 12. Efficiency versus Input Power

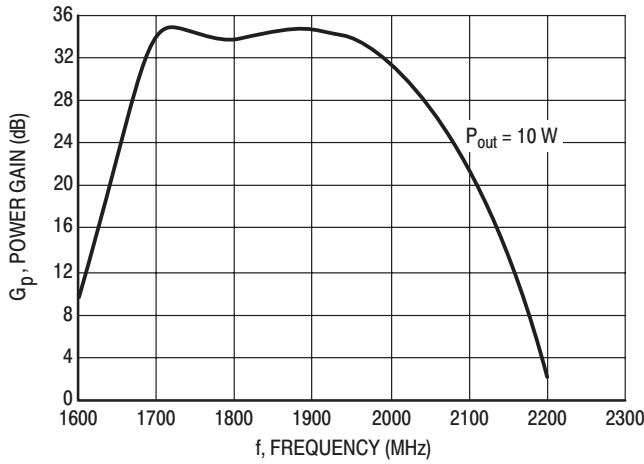

Figure 13. Power Gain versus Frequency

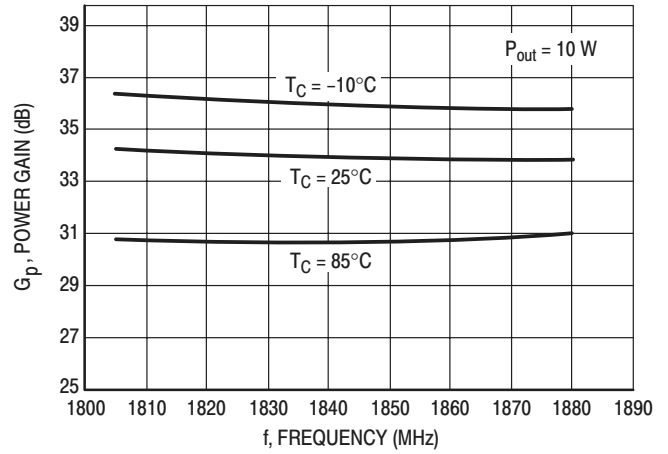

Figure 14. Gain versus Frequency

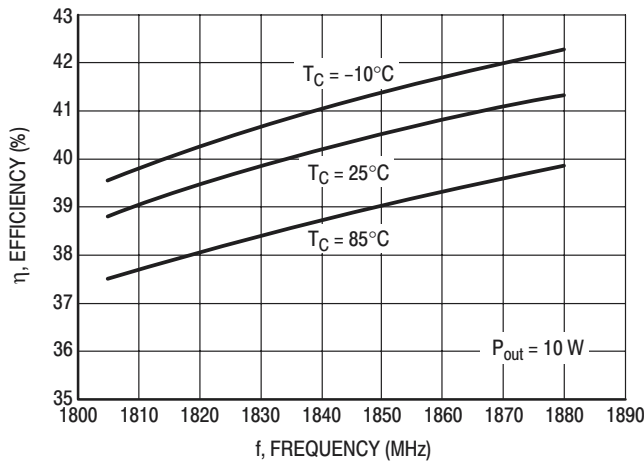

Figure 15. Efficiency versus Frequency

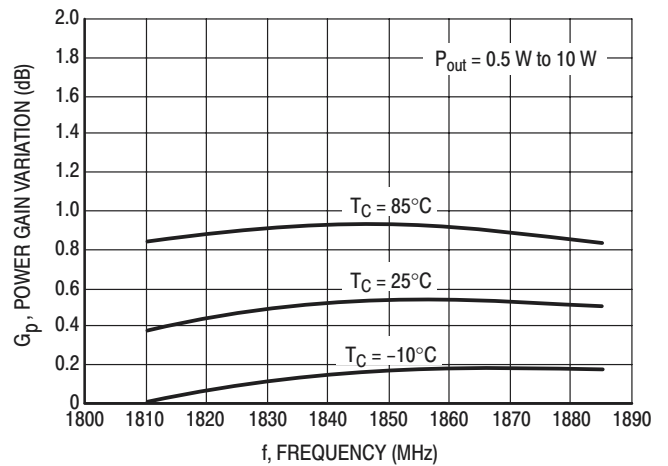

Figure 16. Power Gain Variation versus Frequency

ARCHIVE INFORMATION

ARCHIVE INFORMATION

TYPICAL CHARACTERISTICS  
MHW1810-2

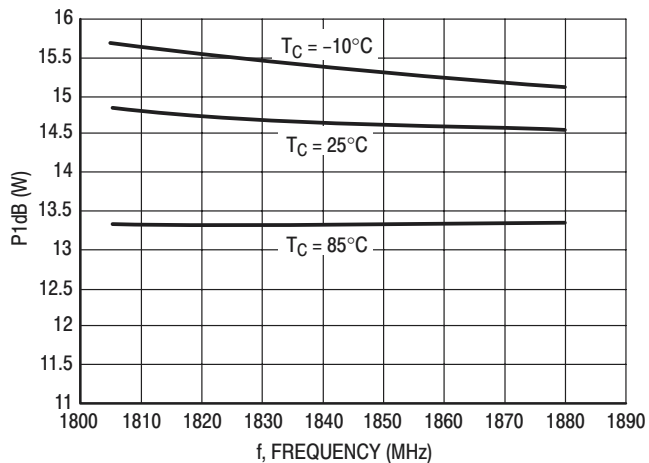

Figure 17. P1dB versus Frequency

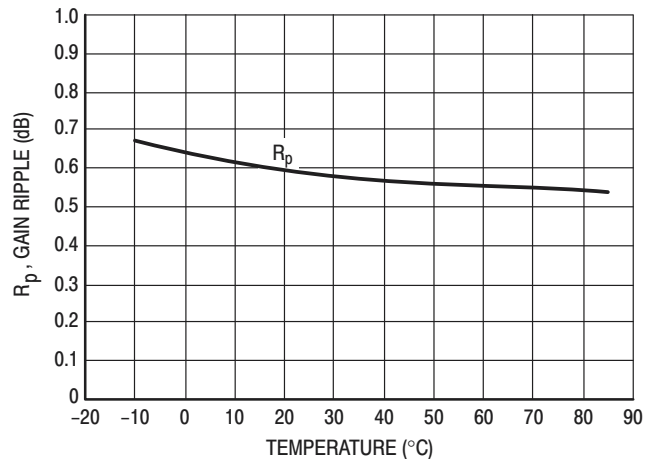

Figure 18. Gain Ripple versus Temperature

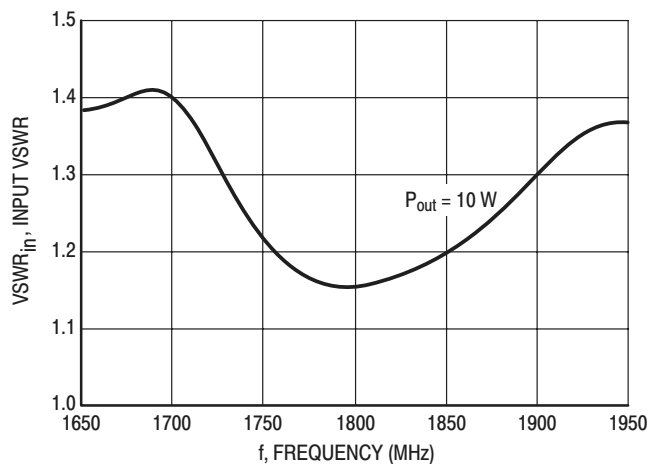

Figure 19. Input VSWR

ARCHIVE INFORMATION

ARCHIVE INFORMATION

# NOTES

## PACKAGE DIMENSIONS

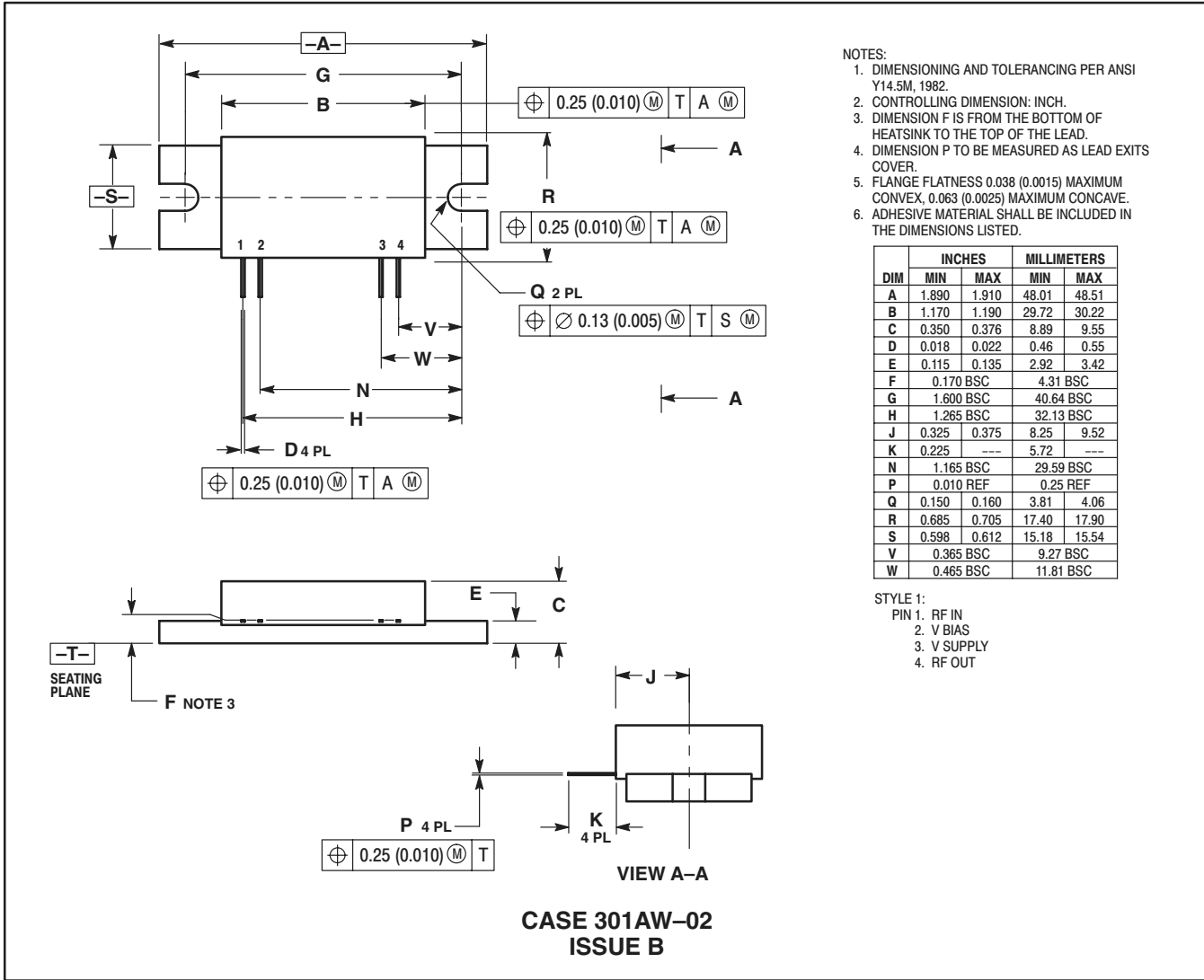

Motorola reserves the right to make changes without further notice to any products herein. Motorola makes no warranty, representation or guarantee regarding the suitability of its products for any particular purpose, nor does Motorola assume any liability arising out of the application or use of any product or circuit, and specifically disclaims any and all liability, including without limitation consequential or incidental damages. "Typical" parameters which may be provided in Motorola data sheets and/or specifications can and do vary in different applications and actual performance may vary over time. All operating parameters, including "Typicals" must be validated for each customer application by customer's technical experts. Motorola does not convey any license under its patent rights nor the rights of others. Motorola products are not designed, intended, or authorized for use as components in systems intended for surgical implant into the body, or other applications intended to support or sustain life, or for any other application in which the failure of the Motorola product could create a situation where personal injury or death may occur. Should Buyer purchase or use Motorola products for any such unintended or unauthorized application, Buyer shall indemnify and hold Motorola and its officers, employees, subsidiaries, affiliates, and distributors harmless against all claims, costs, damages, and expenses, and reasonable attorney fees arising out of, directly or indirectly, any claim of personal injury or death associated with such unintended or unauthorized use, even if such claim alleges that Motorola was negligent regarding the design or manufacture of the part. Motorola, Inc. Motorola, Inc. is an Equal Opportunity/Affirmative Action Employer. MOTOROLA and the logo are registered in the US Patent & Trademark Office. All other product or service names are the property of their respective owners.

© Motorola, Inc. 2002.

**How to reach us:**

**USA/EUROPE/Locations Not Listed:** Motorola Literature Distribution; P.O. Box 5405, Denver, Colorado 80217. 1-303-675-2140 or 1-800-441-2447

**JAPAN:** Motorola Japan Ltd.; SPS, Technical Information Center, 3-20-1, Minami-Azabu. Minato-ku, Tokyo 106-8573 Japan. 81-3-3440-3569

**ASIA/PACIFIC:** Motorola Semiconductors H.K. Ltd.; Silicon Harbour Centre, 2 Dai King Street, Tai Po Industrial Estate, Tai Po, N.T., Hong Kong. 852-26668334

**Technical Information Center: 1-800-521-6274**

**HOME PAGE:** <http://www.motorola.com/semiconductors/>

