



Product Description

RFMD's SGC4563Z is a high performance SiGe HBT MMIC amplifier utilizing a Darlington configuration with a patented active bias network. The active bias network provides stable current over temperature and process Beta variations. Designed to run directly from a 3V supply, the SGC4563Z does not require a dropping resistor as compared to typical Darlington amplifiers. The SGC4563Z is designed for high linearity 3V gain block applications that require small size and minimal external components. It is internally matched to 50Ω.

Optimum Technology Matching® Applied

- GaAs HBT
- GaAs MESFET
- InGaP HBT
- SiGe BiCMOS
- Si BiCMOS
- SiGe HBT
- GaAs pHEMT
- Si CMOS
- Si BJT
- GaN HEMT
- RF MEMS

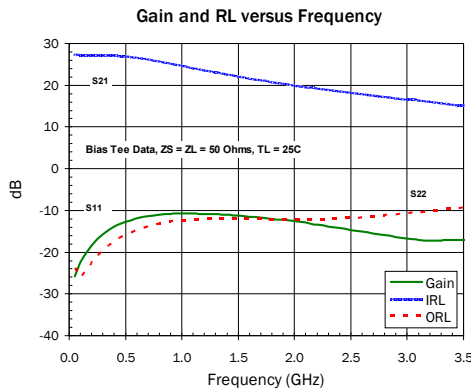

Features

- Single Fixed 3V Supply
- No Dropping Resistor Required
- Patented Self-Bias Circuitry
- P_{1dB} = 15.6dBm at 1950MHz
- OIP₃ = 28.5dBm at 1950MHz
- Robust 1000V ESD, Class 1C HBM

Applications

- PA Driver Amplifier
- Cellular, PCS, GSM, UMTS, WCDMA
- IF Amplifier
- Wireless Data, Satellite

Parameter	Specification			Unit	Condition
	Min.	Typ.	Max.		
Small Signal Gain		26.5		dB	Freq = 500MHz
	22.5	25.5	28.5	dB	Freq = *850MHz
	18.5	20.5	22.5	dB	Freq = 1950MHz
Output Power at 1dB Compression		16.8		dBm	Freq = 500MHz
		16.5		dBm	Freq = 850MHz
	14.0	15.6		dBm	Freq = 1950MHz
Output Third Order Intercept Point		29.5		dBm	Freq = 500MHz
		29.5		dBm	Freq = 850MHz
	26.0	28.5		dBm	Freq = 1950MHz
Input Return Loss	14.0	18.0		dB	Freq = 1950MHz
Output Return Loss	10.0	14.0		dB	Freq = 1950MHz
Noise Figure		1.7	3.0	dB	Freq = 1930MHz
Device Operating Voltage		3		V	
Device Operating Current	37	48	59	mA	
Thermal Resistance		120		°C/W	(R _{TH, j-l}) Junction to lead

Test Conditions: V_D = 3.0V, I_D = 48mA, T_L = 25 °C, OIP3 Tone Spacing = 1MHz. *Bias Tee Data, Z_S = Z_L = 50Ω, P_{OUT} per tone = 0dBm, Application Circuit Data Unless Otherwise Noted

Absolute Maximum Ratings

Parameter	Rating	Unit
Max Device Current (I_{CE})	110	mA
Max Device Voltage (V_{CE})	4	V
Max RF Input Power* (See Note)	12	dBm
Max Junction Temp (T_J)	+150	°C
Operating Temp Range (T_L)	-55 to +105	°C
Max Storage Temp	+150	°C
ESD Rating - Human Body Model (HBM)	Class 1C	
Moisture Sensitivity Level	MSL 1	

*Note: Load condition 1, $Z_L = 50\Omega$;
Load condition 2, $Z_L = 10:1$ VSWR

Operation of this device beyond any one of these limits may cause permanent damage. For reliable continuous operation, the device voltage and current must not exceed the maximum operating values specified in the table on page one.

Bias Conditions should also satisfy the following expression:
 $I_D V_D < (T_J - T_L) / R_{TH}$, $J-H$ and $T_L = \text{Source Lead Temperature}$



Caution! ESD sensitive device.

Exceeding any one or a combination of the Absolute Maximum Rating conditions may cause permanent damage to the device. Extended application of Absolute Maximum Rating conditions to the device may reduce device reliability. Specified typical performance or functional operation of the device under Absolute Maximum Rating conditions is not implied.

The information in this publication is believed to be accurate and reliable. However, no responsibility is assumed by RF Micro Devices, Inc. ("RFMD") for its use, nor for any infringement of patents, or other rights of third parties, resulting from its use. No license is granted by implication or otherwise under any patent or patent rights of RFMD. RFMD reserves the right to change component circuitry, recommended application circuitry and specifications at any time without prior notice.



RFMD Green: RoHS compliant per EU Directive 2002/95/EC, halogen free per IEC 61249-2-21, < 1000ppm each of antimony trioxide in polymeric materials and red phosphorus as a flame retardant, and <2% antimony in solder.

Typical RF Performance with Application Circuit at Key Operating Frequencies (Bias Tee)

Parameter	Unit	*100 MHz	500 MHz	850 MHz	1950 MHz	*2500 MHz	*3500 MHz
Small Signal Gain (G)	dB	27.5	26.5	25.5	20.5	18.5	15.0
Output Third Order Intercept Point (OIP_3)	dBm	30.5	29.5	29.5	28.5	25.5	22.5
Output Power at 1dB Compression (P_{1dB})	dBm	16.9	16.8	16.5	15.6	14.0	11.6
Input Return Loss (IRL)	dB	23.0	18.5	29.5	18.0	14.0	17.0
Output Return Loss (ORL)	dB	26.5	19.5	20.5	14.0	12.0	9.5
Reverse Isolation (S_{12})	dB	28.5	29.0	28.5	23.5	22.5	20.0
Noise Figure (NF)	dB	1.3	1.6	1.7	1.7	1.6	2.1

Test Conditions: $V_D = 3V$, $I_D = 48mA$, OIP_3 Tone Spacing = 1MHz, P_{OUT} per tone = 0dBm
 $T_L = 25^\circ C$, $Z_S = Z_L = 50\Omega$, *Bias Tee Data

Typical Performance with Bias Tee, $V_D = 3V$, $I_D = 48mA$

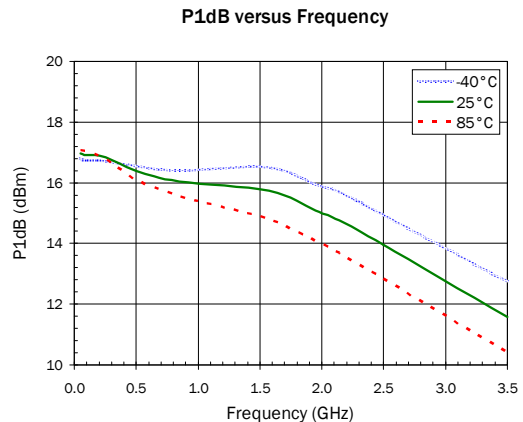
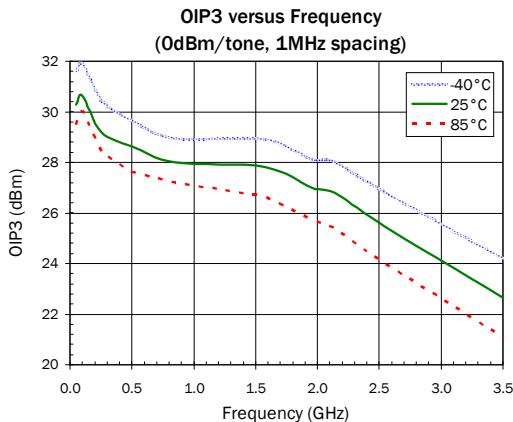

Typical Performance with Bias Tee, $V_D=3V$, $I_D=48mA$

Noise Figure versus Frequency/Temperature

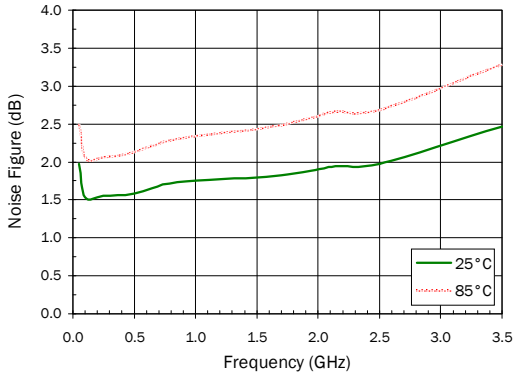

DCIV versus Temperature

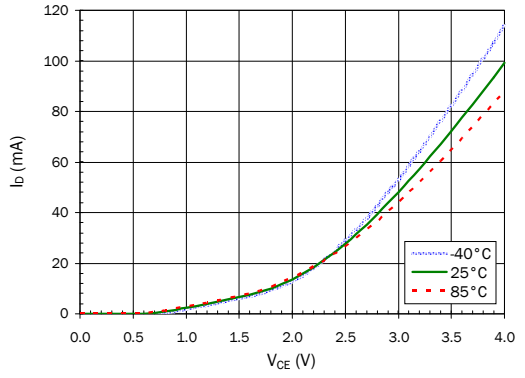

S11 versus Frequency

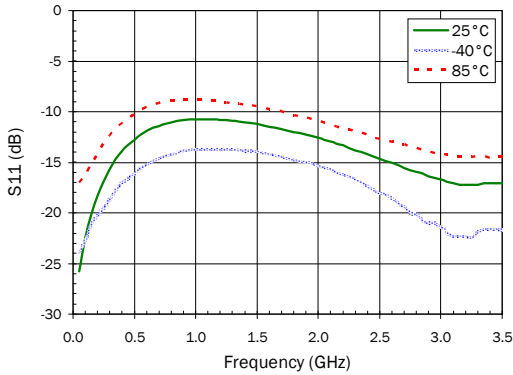

S21 versus Frequency

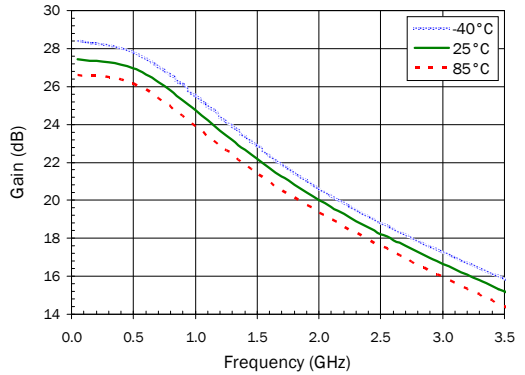

S12 versus Frequency

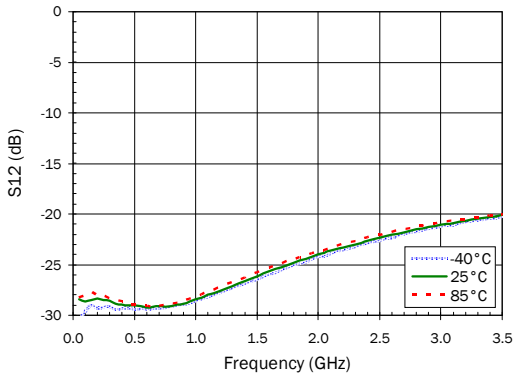

S22 versus Frequency

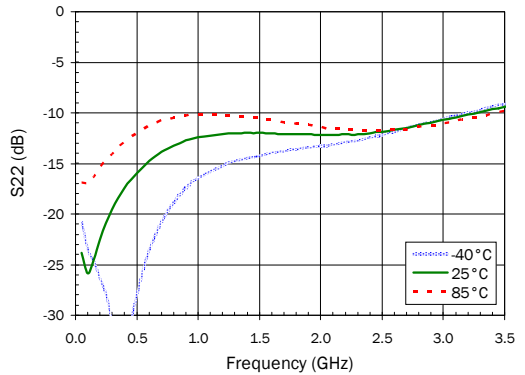

Typical Performance with 0.5GHz to 1GHz Application Circuit, $V_D=3V$, $I_D=48mA$

OIP3 versus Frequency
(0dBm/tone, 1MHz spacing)

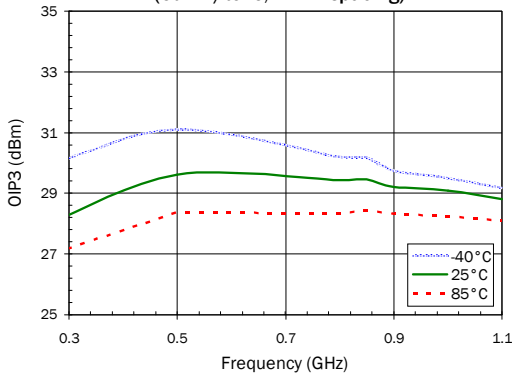

P1dB versus Frequency

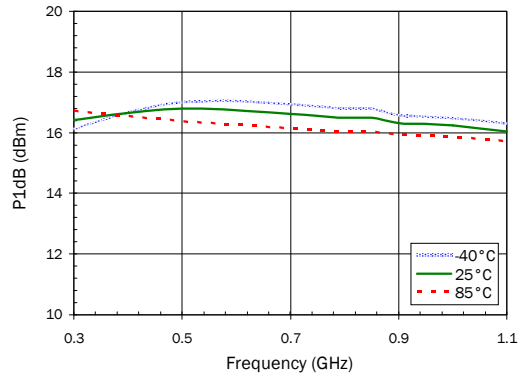

P_{OUT} vs P_{IN} @ 850MHz

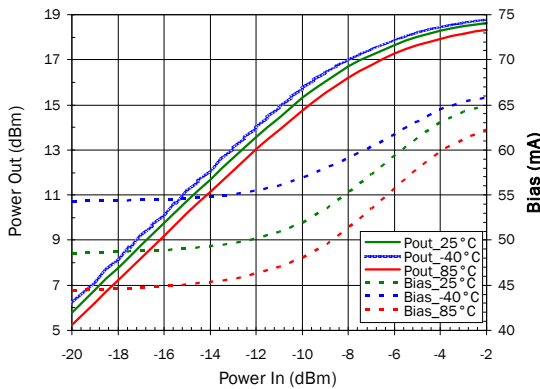

Noise Figure versus Frequency/Temperature

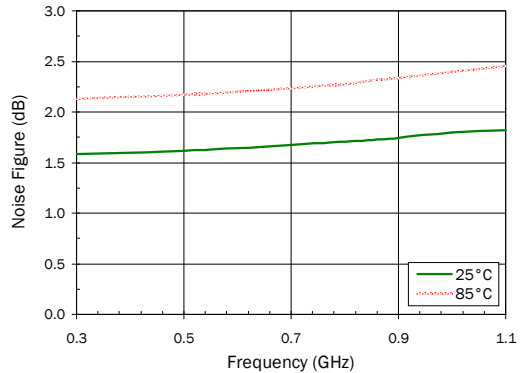

S11 versus Frequency

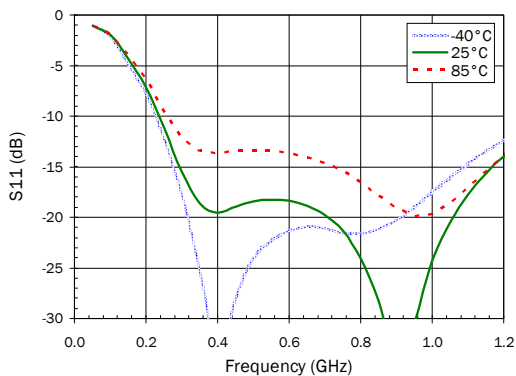

S21 versus Frequency

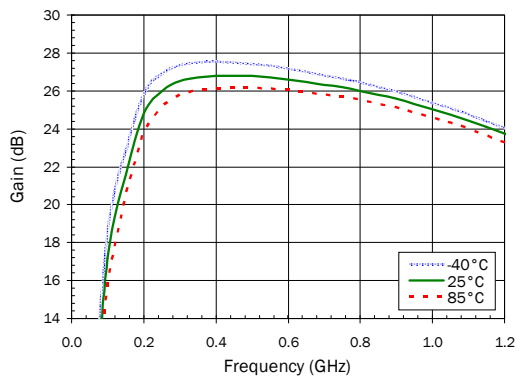

Typical Performance with 0.5GHz to 1GHz Application Circuit, $V_D=3V$, $I_D=48mA$

S12 versus Frequency

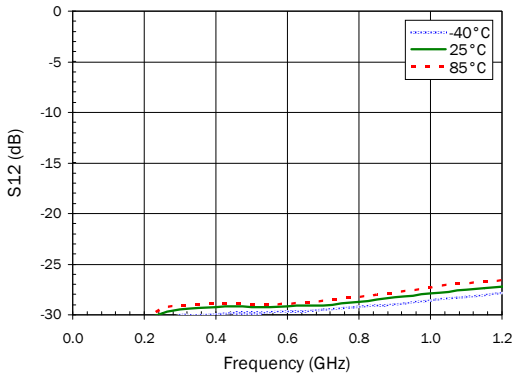

S22 versus Frequency

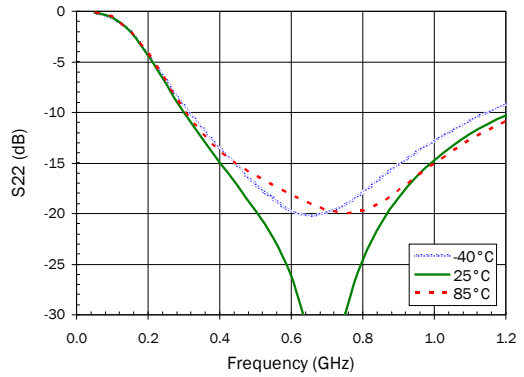

Typical Performance with 1.7GHz to 2.2GHz Application Circuit, $V_D=3V$, $I_D=48mA$

Noise Figure versus Frequency

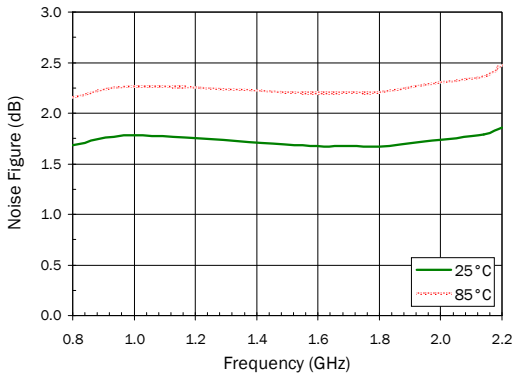

OIP3 versus Frequency (0dBm/tone, 1MHz spacing)

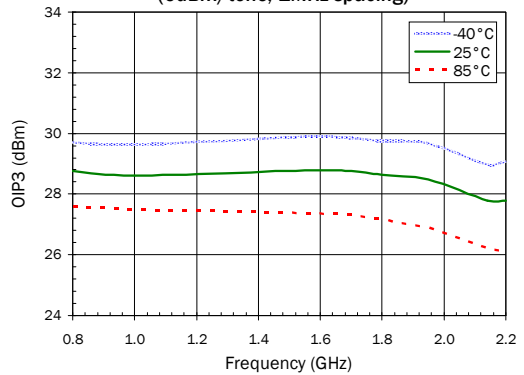

P_{OUT} vs P_{IN} @ 2140MHz

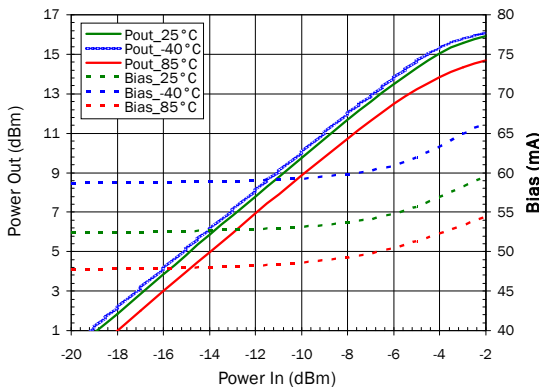

P1dB versus Frequency

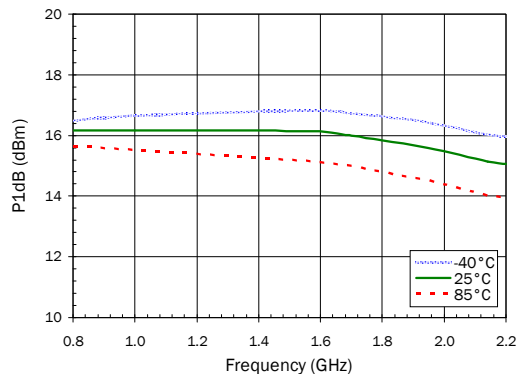

Typical Performance with 1.7GHz to 2.2GHz Application Circuit, $V_D=3V$, $I_D=48mA$

S11 versus Frequency

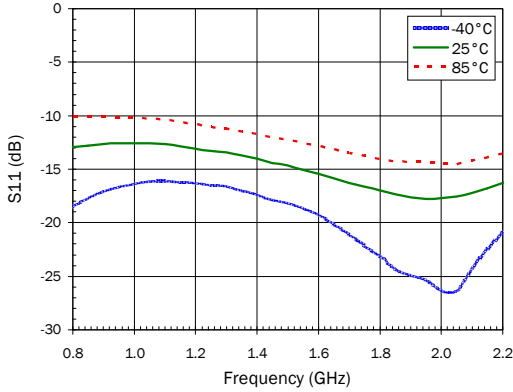

S21 versus Frequency

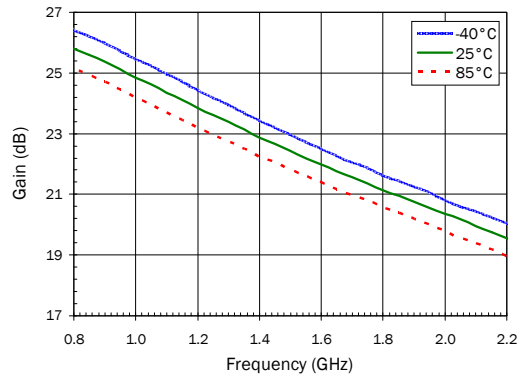

S12 versus Frequency

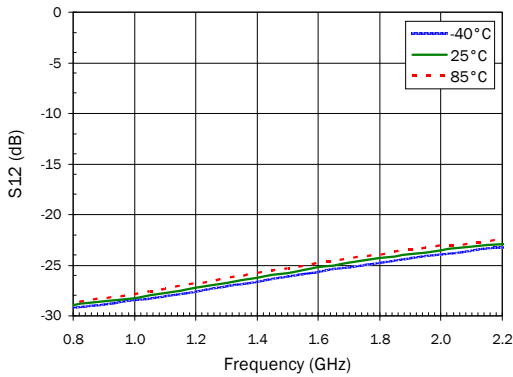

S22 versus Frequency

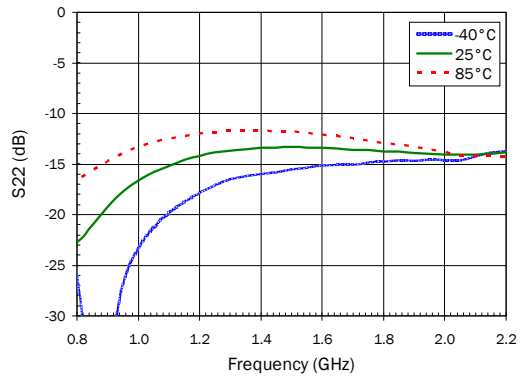

Gain over Temperature

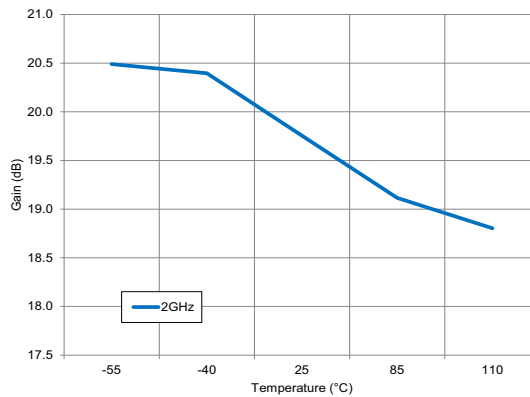

SOT-363 PCB Pad Layout

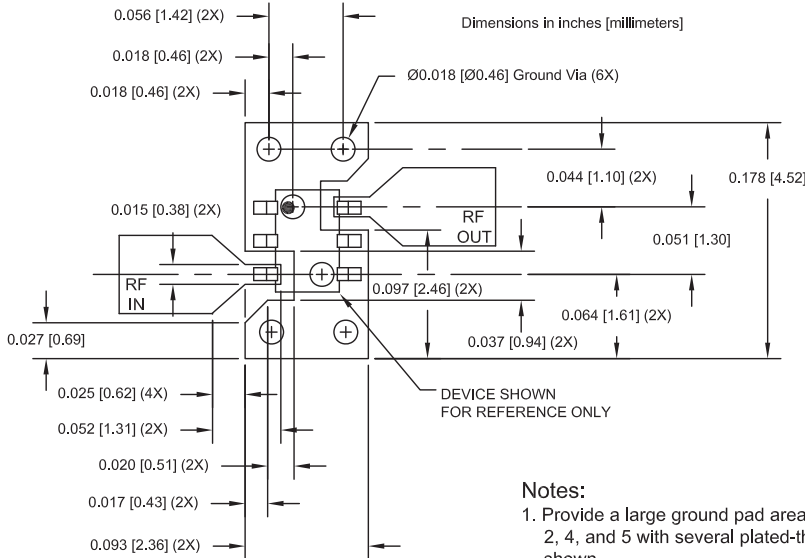

Notes:

1. Provide a large ground pad area under device pins 1, 2, 4, and 5 with several plated-through holes placed as shown.
2. 1/2 ounce finished copper thickness is recommended.
3. RF I/O lines are 50Ω

Package Drawing

Dimensions in inches (millimeters)

Refer to drawing posted at www.rfmd.com for tolerances.

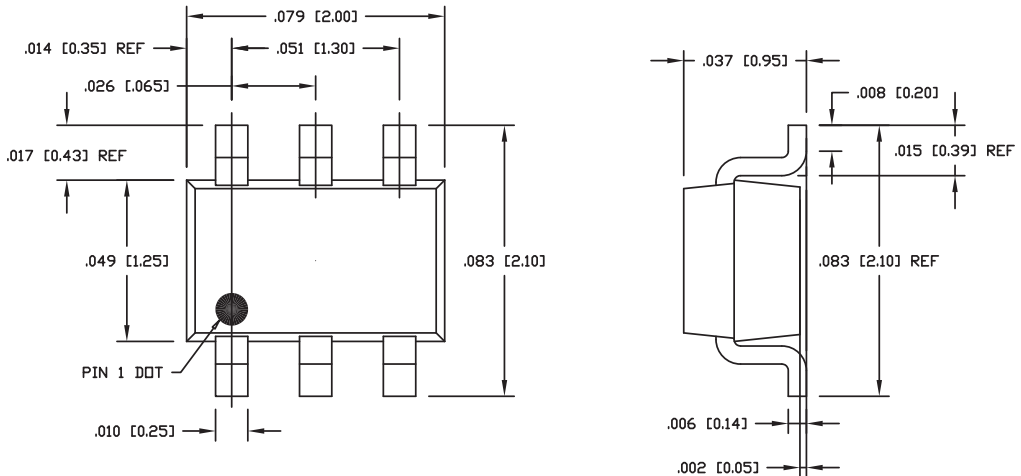

Application Schematic

500 MHz to 1000 MHz

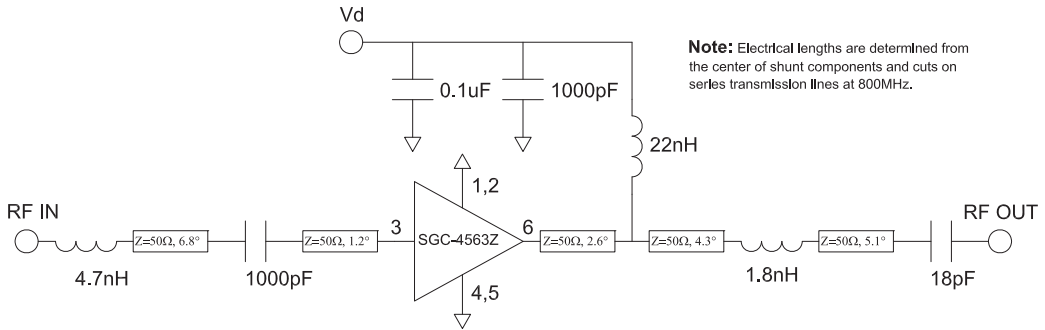

Evaluation Board Layout

500 MHz to 1000 MHz

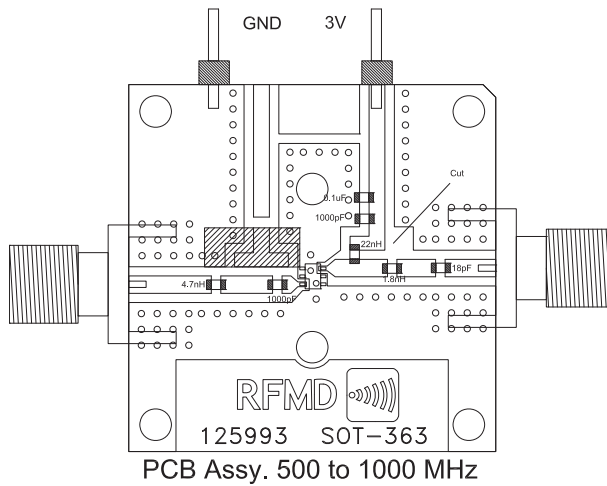

Application Schematic

1700 MHz to 2200 MHz

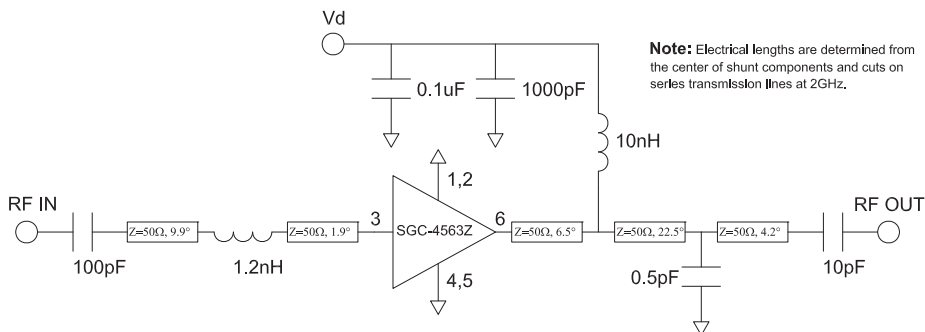

Evaluation Board Layout

1700 MHz to 2200 MHz

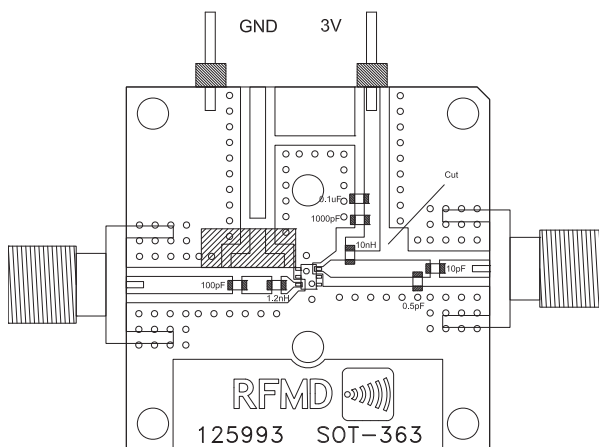

PCB Assy. 1700 to 2200 MHz

Pin	Function	Description
3	RF IN	RF input pin. This pin requires the use of an external DC blocking capacitor chosen for the frequency of operation.
1,2,4,5	GND	Connection to ground. Use via holes as close to the device ground leads as possible to reduce ground inductance and achieve optimum RF performance.
6	RF OUT/DC BIAS	RF output and bias pin. This pin requires the use of an external DC blocking capacitor chosen for the frequency of operation.

Part Identification Marking

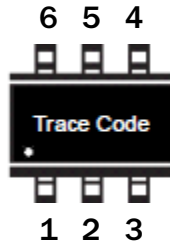

Ordering Information

Ordering Code	Description
SGC4563Z	7" Reel with 3000 pieces
SGC4563ZSQ	Sample bag with 25 pieces
SGC4563ZSR	7" Reel with 100 pieces
SGC4563ZPCK1	500MHz to 1000MHz PCBA with 5-piece sample bag
SGC4563ZPCK2	1700MHz to 2200MHz PCBA with 5-piece sample bag

Mouser Electronics

Authorized Distributor

Click to View Pricing, Inventory, Delivery & Lifecycle Information:

[Qorvo:](#)

[SGC4563Z](#)