

Product Features

- DC-6 GHz
- Single Voltage Supply
- Internally Matched to 50 Ohms
- Unconditionally Stable
- Low Performance Variation Over Temperature
- Transient Protected
- Aqueous washable
- Protected By US Patent 6,943,629



Generic photo used for illustration purposes only

ERA-2SM+

CASE STYLE: WW107

+RoHS Compliant

The +Suffix identifies RoHS Compliance. See our web site for RoHS Compliance methodologies and qualifications

Typical Applications

- Cellular/ PCS/ 3G Base Station
- CATV, Cable Modem & DBS
- Fixed Wireless & WLAN
- Microwave Radio & Test Equipment

General Description

ERA-2SM+ (RoHS compliant) is a wideband amplifier offering high dynamic range. It has repeatable performance from lot to lot. It is enclosed in a Micro-X package. ERA-2SM+ uses Darlington configuration and is fabricated using InGaP HBT technology. Expected MTTF is 8,000 years at 85°C case temperature.

simplified schematic and pin description

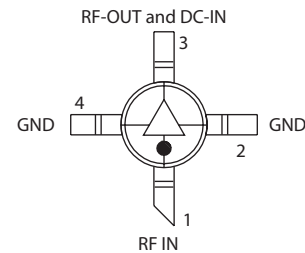
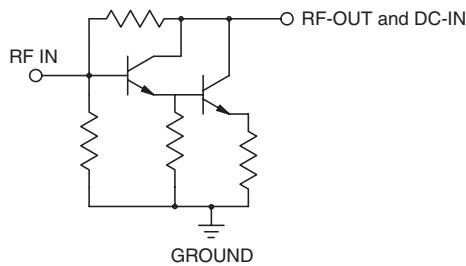

Function	Pin Number	Description
RF IN	1	RF input pin. This pin requires the use of an external DC blocking capacitor chosen for the frequency of operation.
RF-OUT and DC-IN	3	RF output and bias pin. DC voltage is present on this pin; therefore a DC blocking capacitor is necessary for proper operation. An RF choke is needed to feed DC bias without loss of RF signal due to the bias connection, as shown in "Recommended Application Circuit".
GND	2,4	Connections to ground. Use via holes as shown in "Suggested Layout for PCB Design" to reduce ground path inductance for best performance.

Notes

- A. Performance and quality attributes and conditions not expressly stated in this specification document are intended to be excluded and do not form a part of this specification document.
 B. Electrical specifications and performance data contained in this specification document are based on Mini-Circuit's applicable established test performance criteria and measurement instructions.
 C. The parts covered by this specification document are subject to Mini-Circuits standard limited warranty and terms and conditions (collectively, "Standard Terms"); Purchasers of this part are entitled to the rights and benefits contained therein. For a full statement of the Standard Terms and the exclusive rights and remedies thereunder, please visit Mini-Circuits' website at www.minicircuits.com/MCLStore/terms.jsp



Electrical Specifications at 25°C and 40mA, unless noted

Parameter	Min.	Typ.	Max.	Units	Cpk	
Frequency Range*	DC		6	GHz		
Gain	f=0.01 GHz	15.4	16.4	17.3	dB	≥ 1.5
	f=0.1 GHz	15.4	16.4	17.3		
	f=1 GHz	—	15.8	—		
	f=2 GHz	13.7	14.9	16.5		
	f=3 GHz	—	13.9	—		
	f=4 GHz	11.6	12.5	14.6		
Magnitude of Gain Variation versus Temperature (values are negative)	f=0.1 GHz	—	.0025	.005	dB/°C	
	f=1 GHz	—	.003	.006		
	f=2 GHz	—	.0035	.007		
	f=3 GHz	—	.0045	.009		
	f=4 GHz	—	.0045	.009		
	f=6 GHz	—	.006	.011		
Input Return Loss	f=0.1 GHz		30	dB		
	f=3 GHz		25			
	f=6 GHz		22			
Output Return Loss	f=0.1 GHz		25	dB		
	f=3 GHz		16			
	f=6 GHz		14			
Reverse Isolation	f=3 GHz	18	20	—	dB	
Output Power @ 1 dB compression	f=0.1 GHz	—	13.1	—	dBm	≥ 1.33
	f=2 GHz	11	13	—		
	f=4 GHz	—	11	—		
Saturated Output Power (at 3dB compression)	f=0.1 GHz		14		dBm	
	f=2 GHz		13			
	f=4 GHz		12			
Output IP3	f=0.1 GHz	25	29	—	dBm	≥ 1.33
	f=2 GHz	25	29	—		
	f=4 GHz	20	25	—		
Noise Figure	f=0.1 GHz	—	3.2	3.7	dB	≥ 1.33
	f=2 GHz	—	3.3	3.8		
	f=4 GHz	—	3.4	4		
Group Delay	f=2 GHz		80		psec	
Recommended Device Operating Current			40		mA	
Device Operating Voltage	3.20	3.4	3.6		V	≥ 1.5
Device Voltage Variation vs. Temperature at 40mA			-2.5		mV/°C	
Device Voltage Variation vs. Current at 25°C			8.1		mV/mA	
Thermal Resistance, junction-to-case ¹			160		°C/W	

*Guaranteed specification DC-6 GHz. Low frequency cut off determined by external coupling capacitors.

Absolute Maximum Ratings

Parameter	Ratings
Operating Temperature*	-45°C to 85°C
Storage Temperature	-65°C to 150°C
Operating Current	75mA
Power Dissipation	330mW
Input Power	15dBm

Note: Permanent damage may occur if any of these limits are exceeded. These ratings are not intended for continuous normal operation.
¹Case is defined as ground leads.
 *Based on typical case temperature rise 5°C above ambient.

Notes

- A. Performance and quality attributes and conditions not expressly stated in this specification document are intended to be excluded and do not form a part of this specification document.
- B. Electrical specifications and performance data contained in this specification document are based on Mini-Circuit's applicable established test performance criteria and measurement instructions.
- C. The parts covered by this specification document are subject to Mini-Circuits standard limited warranty and terms and conditions (collectively, "Standard Terms"); Purchasers of this part are entitled to the rights and benefits contained therein. For a full statement of the Standard Terms and the exclusive rights and remedies thereunder, please visit Mini-Circuits' website at www.minicircuits.com/MCLStore/terms.jsp



Product Marking

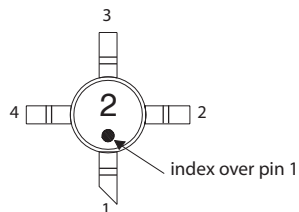

Markings in addition to model number designation may appear for internal quality control purposes.

Additional Detailed Technical Information

Additional information is available on our web site. To access this information enter the model number on our web site home page.

Performance data, graphs, s-parameter data set (.zip file)

Case Style: WW107

Plastic micro-x, .085 body diameter, lead finish: Matte-Tin

Tape & Reel: F4

7" Reels with 20, 50, 100, 200, 500, 1K devices

Suggested Layout for PCB Design: PL-075

Evaluation Board: TB-408-2+

Environmental Ratings: ENV08T2

Recommended Application Circuit

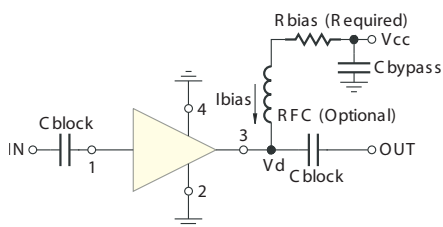

Test Board includes case, connectors, and components (in bold) soldered to PCB

R BIAS	
Vcc	"1%" Res. Values (ohms) for Optimum Biasing
7	88.7
8	113
9	137
10	162
11	187
12	213
13	237
14	261
15	287
16	309
17	332
18	365
19	392

Notes

- A. Performance and quality attributes and conditions not expressly stated in this specification document are intended to be excluded and do not form a part of this specification document.
- B. Electrical specifications and performance data contained in this specification document are based on Mini-Circuit's applicable established test performance criteria and measurement instructions.
- C. The parts covered by this specification document are subject to Mini-Circuits' standard limited warranty and terms and conditions (collectively, "Standard Terms"); Purchasers of this part are entitled to the rights and benefits contained therein. For a full statement of the Standard Terms and the exclusive rights and remedies thereunder, please visit Mini-Circuits' website at www.minicircuits.com/MCLStore/terms.jsp



ESD Rating

Human Body Model (HBM): Class 1A (250 v to < 500 v) in accordance with ANSI/ESD STM 5.1 - 2001

Machine Model (MM): Class M1 (< 100 v) in accordance with ANSI/ESD STM 5.2 - 1999

MSL Rating

Moisture Sensitivity: MSL1 in accordance with IPC/JEDECJ-STD-020C

No.	Test Required	Condition	Standard	Quantity
1	Visual Inspection	Low Power Microscope Magnification 40x	MIP-IN-0003 (MCT spec)	45 units
2	Electrical Test	Room Temperature	SCD (MCL spec)	45 units
3	SAM Analysis	Less than 10% growth in term of delamination	J-Std-020C (Jedec Standard)	45 units
4	Moisture Sensitivity Level 1	Bake at 125°C for 24 hours Soak at 85°C/85%RH for 168 hours Reflow 3 cycles at 260°C peak	J-Std-020C (Jedec Standard)	45 units

MSL Test Flow Chart

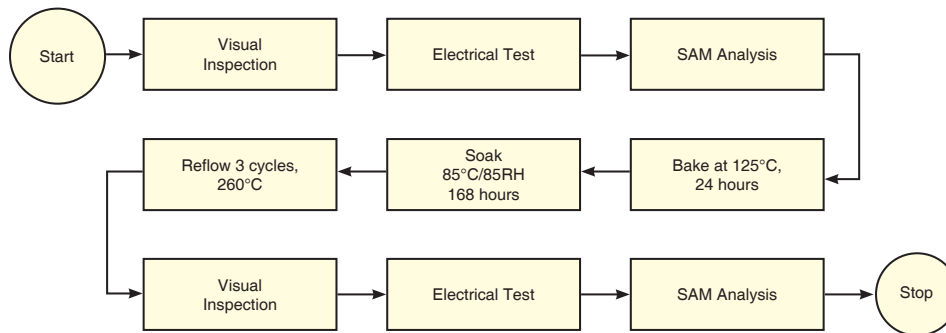

Notes

- A. Performance and quality attributes and conditions not expressly stated in this specification document are intended to be excluded and do not form a part of this specification document.
- B. Electrical specifications and performance data contained in this specification document are based on Mini-Circuit's applicable established test performance criteria and measurement instructions.
- C. The parts covered by this specification document are subject to Mini-Circuits standard limited warranty and terms and conditions (collectively, "Standard Terms"); Purchasers of this part are entitled to the rights and benefits contained therein. For a full statement of the Standard Terms and the exclusive rights and remedies thereunder, please visit Mini-Circuits' website at www.minicircuits.com/MCLStore/terms.jsp



MMIC Amplifier

ERA-2SM+

Typical Performance Data

**NOTE: Use PDF Bookmarks to view DATA at required conditions
or to view GRAPHS.**

Definitions:

Input Return Loss = -S11 (dB)

Gain(Power Gain) = S21 (dB)

Reverse Isolation = -S12 (dB)

Output Return Loss = -S22 (dB)

TEST CONDITIONS: Icc = 40mA, Vd = 3.43V @Temperature = +25degC

FREQ	Gain	Isolation	Input Return Loss	Output Return Loss	Stability		IP3 Output	1dB Comp. Output	Noise Figure
					K	Delta			
(MHz)	(dB)	(dB)	(dB)	(dB)	K	Delta	(dBm)	(dBm)	(dB)
50	16.34	19.72	33.63	31.10	1.07	0.68	29.48	13.77	3.13
100	16.33	19.78	34.04	30.03	1.08	0.67	29.39	13.69	3.14
200	16.27	19.77	33.71	29.05	1.08	0.67	29.76	13.87	3.18
300	16.22	19.78	33.24	28.57	1.08	0.66	29.58	13.83	3.17
400	16.16	19.79	32.85	27.70	1.09	0.66	29.41	13.71	3.14
500	16.09	19.77	32.38	26.53	1.09	0.65	29.20	13.73	3.19
600	16.01	19.76	31.70	25.45	1.09	0.65	29.08	13.73	3.21
700	15.94	19.75	30.87	24.57	1.09	0.64	29.08	13.76	3.19
800	15.86	19.76	30.24	23.60	1.10	0.64	29.51	13.65	3.25
900	15.77	19.75	29.34	22.60	1.10	0.63	29.10	13.49	3.22
1000	15.69	19.75	28.66	21.92	1.10	0.62	29.06	13.53	3.16
1100	15.61	19.75	27.96	21.31	1.11	0.62	29.24	13.39	3.24
1200	15.52	19.76	27.46	20.71	1.11	0.61	29.27	13.45	3.21
1300	15.43	19.76	27.18	20.22	1.11	0.60	29.10	13.56	3.28
1400	15.33	19.76	26.86	19.71	1.12	0.60	29.11	13.47	3.31
1500	15.24	19.77	26.45	19.28	1.12	0.59	29.29	13.49	3.24
1600	15.14	19.79	26.07	18.92	1.13	0.58	29.53	13.43	3.27
1700	15.05	19.80	25.96	18.62	1.13	0.57	30.02	13.54	3.30
1800	14.94	19.80	25.97	18.33	1.14	0.57	29.99	13.56	3.33
2000	14.76	19.82	25.90	17.89	1.15	0.55	29.70	13.60	3.34
2200	14.55	19.86	25.75	17.53	1.17	0.54	29.49	13.62	3.30
2400	14.35	19.90	25.86	17.26	1.18	0.52	29.22	13.40	3.21
2600	14.15	19.95	25.78	17.16	1.20	0.51	28.96	13.32	3.27
2800	13.93	20.00	25.76	17.09	1.22	0.49	29.08	13.31	3.28
3000	13.73	20.05	25.64	17.15	1.25	0.48	28.88	13.28	3.24
3200	13.54	20.10	25.68	17.30	1.27	0.46	28.46	13.04	3.28
3400	13.34	20.18	25.32	17.37	1.30	0.45	28.19	12.82	3.30
3600	13.13	20.31	24.79	17.41	1.33	0.43	27.31	12.50	3.37
3800	12.96	20.36	24.82	17.66	1.36	0.42	26.77	12.50	3.34
4000	12.77	20.46	24.67	17.80	1.39	0.41	26.35	12.33	3.33
4200	12.62	20.48	25.79	18.07	1.41	0.40	25.88	12.26	3.34
4400	12.46	20.54	27.02	18.48	1.44	0.39	25.71	11.91	3.31
4600	12.23	20.74	26.97	18.22	1.49	0.37	25.19	11.86	3.41
4800	12.07	20.83	28.73	18.54	1.53	0.36	24.96	11.88	3.46
5000	11.88	20.89	31.45	18.69	1.57	0.35	25.08	11.56	3.45
5200	11.77	20.96	37.23	19.36	1.60	0.35	25.04	11.22	3.54
5400	11.62	21.02	42.10	19.62	1.63	0.34	24.75	10.91	3.48
5600	11.37	21.08	32.11	19.61	1.67	0.33	24.17	10.62	3.43
5800	11.14	21.20	28.39	19.31	1.73	0.32	23.54	10.74	3.48
6000	11.07	21.49	28.36	19.52	1.79	0.30	23.41	10.66	3.64

REV. X1
ERA-2SM+
070816
Page 1 of 11



IF/RF MICROWAVE COMPONENTS • ISO 9001 ISO 14001 AS 9100 CERTIFIED • RoHS compliant

P.O. Box 350166, Brooklyn, New York 11235-0003 (718) 934-4500 Fax (718) 332-4661



The Design Engineers Search Engine finds the model you need, Instantly • For detailed performance specs & shopping online see



MMIC Amplifier

ERA-2SM+

Typical Performance Data

Definitions:

Input Return Loss = -S11 (dB)

Gain(Power Gain) = S21 (dB)

Reverse Isolation = -S12 (dB)

Output Return Loss = -S22 (dB)

TEST CONDITIONS: Icc = 32mA, Vd = 3.33V @Temperature = +25degC

FREQ	Gain	Isolation	Input Return Loss	Output Return Loss	Stability		IP3 Output	1dB Comp. Output	Noise Figure
					K	Delta			
(MHz)	(dB)	(dB)	(dB)	(dB)	K	Delta	(dBm)	(dBm)	(dB)
50	16.11	19.58	27.86	43.29	1.08	0.67	26.04	11.86	3.11
100	16.08	19.60	28.38	38.65	1.08	0.67	25.93	11.51	3.11
200	16.03	19.60	28.35	35.31	1.08	0.66	26.22	11.89	3.13
300	15.98	19.60	28.39	34.24	1.09	0.66	26.15	11.93	3.10
400	15.93	19.60	28.28	31.85	1.09	0.65	26.00	11.58	3.11
500	15.86	19.58	28.41	29.82	1.09	0.65	25.86	11.83	3.19
600	15.79	19.58	28.44	28.13	1.09	0.65	25.77	11.61	3.19
700	15.71	19.57	28.38	26.86	1.10	0.64	25.74	11.89	3.17
800	15.63	19.58	28.17	25.51	1.10	0.63	26.12	11.75	3.18
900	15.56	19.58	27.96	24.17	1.10	0.63	25.75	11.38	3.19
1000	15.47	19.57	27.72	23.36	1.11	0.62	25.71	11.62	3.13
1100	15.39	19.57	27.41	22.60	1.11	0.61	25.91	11.19	3.22
1200	15.30	19.59	27.18	21.92	1.11	0.61	25.91	11.43	3.15
1300	15.22	19.59	27.05	21.29	1.12	0.60	25.86	11.62	3.26
1400	15.14	19.59	26.88	20.66	1.12	0.59	25.92	11.48	3.24
1500	15.03	19.62	26.64	20.16	1.13	0.59	26.06	11.59	3.23
1600	14.94	19.62	26.39	19.78	1.13	0.58	26.24	11.47	3.23
1700	14.85	19.63	26.33	19.39	1.14	0.57	26.61	11.77	3.26
1800	14.76	19.64	26.39	19.05	1.14	0.56	26.72	11.78	3.30
2000	14.57	19.68	26.45	18.56	1.16	0.55	26.54	11.84	3.27
2200	14.38	19.72	26.20	18.13	1.17	0.54	26.50	11.88	3.22
2400	14.17	19.78	26.31	17.80	1.19	0.52	26.51	11.62	3.18
2600	13.98	19.81	26.03	17.65	1.21	0.51	26.62	11.44	3.20
2800	13.77	19.89	25.94	17.56	1.23	0.49	26.98	11.68	3.23
3000	13.58	19.95	25.71	17.58	1.26	0.48	26.97	11.90	3.22
3200	13.39	20.01	25.64	17.72	1.28	0.46	26.75	11.87	3.26
3400	13.19	20.09	25.23	17.76	1.31	0.45	26.65	11.72	3.27
3600	12.98	20.22	24.81	17.75	1.34	0.43	26.05	11.53	3.28
3800	12.82	20.28	24.79	18.00	1.37	0.42	25.62	11.55	3.30
4000	12.64	20.40	24.70	18.10	1.40	0.41	25.27	11.54	3.28
4200	12.48	20.45	25.93	18.37	1.43	0.40	24.85	11.43	3.27
4400	12.32	20.51	27.26	18.81	1.46	0.39	24.66	11.13	3.27
4600	12.10	20.72	27.78	18.50	1.51	0.37	24.23	11.01	3.40
4800	11.95	20.82	30.03	18.82	1.55	0.36	24.03	11.10	3.42
5000	11.75	20.91	34.60	18.99	1.59	0.35	24.17	10.86	3.41
5200	11.65	20.99	39.85	19.66	1.62	0.34	24.06	10.53	3.48
5400	11.50	21.07	36.15	19.94	1.66	0.33	23.69	10.29	3.46
5600	11.25	21.12	30.79	19.95	1.70	0.32	23.20	9.97	3.38
5800	11.01	21.29	27.93	19.68	1.77	0.31	22.71	10.05	3.42
6000	10.94	21.61	26.80	19.83	1.84	0.30	22.61	9.94	3.51

REV. X1
ERA-2SM+
070816
Page 2 of 11



IF/RF MICROWAVE COMPONENTS • ISO 9001 ISO 14001 AS 9100 CERTIFIED • RoHS compliant
P.O. Box 350166, Brooklyn, New York 11235-0003 (718) 934-4500 Fax (718) 332-4661



The Design Engineers Search Engine finds the model you need, Instantly • For detailed performance specs & shopping online see



MMIC Amplifier

ERA-2SM+

Typical Performance Data

Definitions:

Input Return Loss = -S11 (dB)

Gain(Power Gain) = S21 (dB)

Reverse Isolation = -S12 (dB)

Output Return Loss = -S22 (dB)

TEST CONDITIONS: Icc = 48mA, Vd = 3.49V @Temperature = +25degC

FREQ	Gain	Isolation	Input Return Loss	Output Return Loss	Stability		IP3 Output	1dB Comp. Output	Noise Figure
					K	Delta			
(MHz)	(dB)	(dB)	(dB)	(dB)	K	Delta	(dBm)	(dBm)	(dB)
50	16.49	19.88	40.53	27.65	1.08	0.68	32.18	15.07	3.18
100	16.47	19.89	40.93	27.06	1.08	0.67	32.10	15.11	3.19
200	16.41	19.93	38.62	26.45	1.08	0.67	32.47	15.11	3.21
300	16.36	19.91	36.90	26.18	1.08	0.66	32.23	15.05	3.20
400	16.30	19.90	35.59	25.57	1.08	0.66	32.03	15.02	3.20
500	16.23	19.89	33.88	24.68	1.09	0.66	31.77	14.98	3.24
600	16.15	19.88	32.43	23.84	1.09	0.65	31.64	15.08	3.24
700	16.08	19.87	31.20	23.23	1.09	0.64	31.54	14.96	3.23
800	15.99	19.87	30.31	22.41	1.09	0.64	31.99	14.80	3.29
900	15.91	19.87	29.13	21.57	1.10	0.63	31.64	14.76	3.24
1000	15.83	19.87	28.31	21.04	1.10	0.63	31.51	14.75	3.18
1100	15.74	19.86	27.53	20.51	1.10	0.62	31.62	14.63	3.28
1200	15.65	19.87	26.97	19.99	1.11	0.61	31.61	14.62	3.23
1300	15.55	19.86	26.61	19.54	1.11	0.60	31.33	14.70	3.33
1400	15.46	19.87	26.24	19.08	1.11	0.60	31.38	14.74	3.36
1500	15.36	19.88	25.82	18.71	1.12	0.59	31.56	14.63	3.32
1600	15.26	19.89	25.42	18.39	1.13	0.58	31.74	14.57	3.29
1700	15.17	19.90	25.30	18.13	1.13	0.57	32.20	14.48	3.34
1800	15.06	19.91	25.29	17.87	1.14	0.57	31.92	14.57	3.36
2000	14.87	19.93	25.20	17.48	1.15	0.55	31.53	14.55	3.39
2200	14.67	19.95	25.08	17.15	1.16	0.54	31.18	14.49	3.33
2400	14.45	19.99	25.20	16.91	1.18	0.52	30.58	14.41	3.25
2600	14.26	20.03	25.23	16.86	1.20	0.51	29.96	14.27	3.28
2800	14.03	20.08	25.27	16.80	1.22	0.49	29.80	14.15	3.31
3000	13.83	20.13	25.26	16.88	1.24	0.48	29.52	13.90	3.28
3200	13.64	20.17	25.33	17.04	1.26	0.46	29.16	13.60	3.36
3400	13.43	20.25	25.05	17.13	1.29	0.45	28.68	13.38	3.35
3600	13.22	20.36	24.48	17.21	1.32	0.43	27.90	13.02	3.41
3800	13.05	20.41	24.52	17.47	1.35	0.42	27.24	12.98	3.39
4000	12.87	20.50	24.33	17.63	1.38	0.41	26.84	12.81	3.38
4200	12.70	20.53	25.27	17.89	1.40	0.40	26.42	12.75	3.42
4400	12.54	20.56	26.29	18.31	1.43	0.39	26.20	12.41	3.41
4600	12.31	20.75	25.90	18.06	1.48	0.37	25.70	12.40	3.54
4800	12.16	20.82	27.10	18.39	1.51	0.36	25.43	12.39	3.55
5000	11.96	20.89	28.56	18.53	1.55	0.35	25.53	12.07	3.58
5200	11.85	20.95	31.63	19.19	1.58	0.35	25.49	11.65	3.59
5400	11.70	20.99	33.79	19.45	1.61	0.34	25.25	11.37	3.55
5600	11.45	21.02	29.98	19.39	1.65	0.33	24.69	11.07	3.54
5800	11.21	21.14	27.15	19.09	1.71	0.32	23.98	11.19	3.61
6000	11.15	21.42	27.99	19.35	1.76	0.31	23.79	11.10	3.70

REV. X1
ERA-2SM+
070816
Page 3 of 11



IF/RF MICROWAVE COMPONENTS • ISO 9001 ISO 14001 AS 9100 CERTIFIED • RoHS compliant
P.O. Box 350166, Brooklyn, New York 11235-0003 (718) 934-4500 Fax (718) 332-4661



The Design Engineers Search Engine finds the model you need, Instantly • For detailed performance specs & shopping online see



MMIC Amplifier

ERA-2SM+

Typical Performance Data

Definitions:

Input Return Loss = -S11 (dB)

Gain(Power Gain) = S21 (dB)

Reverse Isolation = -S12 (dB)

Output Return Loss = -S22 (dB)

TEST CONDITIONS: Icc = 40mA, Vd = 3.60V @Temperature = -45degC

FREQ	Gain	Isolation	Input Return Loss	Output Return Loss	Stability		IP3 Output	1dB Comp. Output	Noise Figure
					K	Delta			
(MHz)	(dB)	(dB)	(dB)	(dB)	K	Delta	(dBm)	(dBm)	(dB)
50	16.41	19.69	31.19	32.95	1.07	0.68	30.34	13.96	2.75
100	16.40	19.74	31.32	32.12	1.07	0.68	30.26	13.94	2.70
200	16.36	19.75	31.23	30.95	1.08	0.68	30.59	14.07	2.68
300	16.32	19.72	31.43	29.78	1.08	0.67	30.51	14.09	2.80
400	16.26	19.73	30.84	28.80	1.08	0.67	30.35	13.93	2.68
500	16.20	19.71	31.09	27.30	1.08	0.67	30.21	14.02	2.73
600	16.13	19.69	30.44	26.02	1.08	0.66	30.06	13.96	2.74
700	16.06	19.69	29.73	25.14	1.08	0.66	30.06	14.07	2.72
800	15.98	19.69	29.33	23.78	1.09	0.65	30.52	13.95	2.74
900	15.91	19.69	28.92	22.50	1.09	0.64	30.15	13.71	2.74
1000	15.83	19.67	28.77	21.62	1.09	0.64	30.09	13.78	2.67
1100	15.74	19.68	27.99	20.93	1.09	0.63	30.33	13.62	2.72
1200	15.66	19.68	27.48	20.54	1.10	0.63	30.37	13.82	2.70
1300	15.57	19.68	27.20	20.02	1.10	0.62	30.25	13.85	2.75
1400	15.48	19.68	26.67	19.36	1.10	0.61	30.27	13.75	2.79
1500	15.39	19.70	25.84	19.07	1.11	0.60	30.55	13.80	2.75
1600	15.29	19.74	25.07	18.69	1.11	0.59	30.73	13.80	2.77
1700	15.21	19.70	25.65	18.29	1.12	0.59	31.20	13.93	2.77
1800	15.11	19.72	25.57	17.91	1.12	0.58	31.22	13.96	2.81
2000	14.93	19.71	24.73	17.97	1.13	0.57	31.06	14.02	2.81
2200	14.73	19.76	25.21	17.10	1.15	0.55	30.92	14.03	2.73
2400	14.54	19.79	25.12	17.04	1.16	0.54	30.59	13.91	2.67
2600	14.35	19.82	24.91	17.12	1.18	0.52	30.34	13.82	2.70
2800	14.13	19.88	24.74	16.87	1.20	0.51	30.41	13.85	2.72
3000	13.95	19.91	24.65	17.22	1.22	0.50	30.27	13.97	2.71
3200	13.75	19.97	25.08	17.02	1.24	0.48	30.15	13.80	2.72
3400	13.56	20.02	24.71	17.42	1.26	0.47	29.77	13.65	2.72
3600	13.33	20.17	24.20	17.00	1.29	0.45	29.04	13.41	2.77
3800	13.19	20.19	23.80	17.60	1.31	0.44	28.43	13.38	2.75
4000	12.99	20.32	23.62	17.56	1.34	0.42	27.98	13.23	2.74
4200	12.84	20.30	24.47	17.92	1.36	0.42	27.59	13.15	2.76
4400	12.71	20.37	25.27	18.50	1.39	0.41	27.46	12.85	2.73
4600	12.47	20.47	25.48	18.41	1.43	0.39	26.90	12.79	2.79
4800	12.32	20.64	25.65	18.48	1.47	0.38	26.59	12.86	2.84
5000	12.17	20.56	27.88	19.27	1.48	0.38	26.60	12.58	2.91
5200	11.99	20.70	28.67	19.13	1.52	0.36	26.68	12.20	2.93
5400	11.85	20.80	30.02	19.49	1.56	0.35	26.42	11.98	2.88
5600	11.62	20.83	28.86	19.37	1.60	0.34	26.00	11.67	2.80
5800	11.48	20.89	27.68	19.85	1.63	0.34	25.24	11.77	2.88
6000	11.26	21.01	26.08	19.27	1.68	0.33	24.92	11.66	2.91

REV. X1
ERA-2SM+
070816
Page 4 of 11



IF/RF MICROWAVE COMPONENTS • ISO 9001 ISO 14001 AS 9100 CERTIFIED • RoHS compliant
P.O. Box 350166, Brooklyn, New York 11235-0003 (718) 934-4500 Fax (718) 332-4661



The Design Engineers Search Engine finds the model you need, Instantly • For detailed performance specs & shopping online see



MMIC Amplifier

ERA-2SM+

Typical Performance Data

Definitions:

Input Return Loss = -S11 (dB)

Gain(Power Gain) = S21 (dB)

Reverse Isolation = -S12 (dB)

Output Return Loss = -S22 (dB)

TEST CONDITIONS: Icc = 32mA, Vd = 3.50V @Temperature = -45degC

FREQ	Gain	Isolation	Input Return Loss	Output Return Loss	Stability		IP3 Output	1dB Comp. Output	Noise Figure
					K	Delta			
(MHz)	(dB)	(dB)	(dB)	(dB)	K	Delta	(dBm)	(dBm)	(dB)
50	16.20	19.57	27.31	49.30	1.07	0.68	26.71	11.77	2.72
100	16.20	19.62	27.41	41.88	1.08	0.67	26.57	11.58	2.69
200	16.16	19.59	27.20	36.41	1.08	0.67	26.85	11.96	2.67
300	16.11	19.57	27.54	34.47	1.08	0.67	26.84	11.94	2.77
400	16.06	19.57	27.36	32.26	1.08	0.67	26.70	11.74	2.64
500	16.00	19.56	27.85	29.84	1.08	0.66	26.59	11.91	2.70
600	15.94	19.54	27.80	28.16	1.08	0.66	26.50	11.68	2.68
700	15.87	19.53	27.57	26.97	1.09	0.65	26.49	11.93	2.68
800	15.79	19.53	27.57	25.23	1.09	0.65	26.86	11.84	2.72
900	15.72	19.54	27.76	23.71	1.09	0.64	26.53	11.37	2.70
1000	15.65	19.52	28.03	22.79	1.09	0.64	26.49	11.58	2.61
1100	15.56	19.54	27.74	22.02	1.10	0.63	26.69	11.23	2.68
1200	15.48	19.54	27.30	21.54	1.10	0.62	26.71	11.58	2.64
1300	15.40	19.53	27.07	20.87	1.10	0.62	26.68	11.75	2.73
1400	15.31	19.54	26.80	20.11	1.11	0.61	26.76	11.52	2.78
1500	15.22	19.54	26.19	19.85	1.11	0.60	26.94	11.67	2.71
1600	15.13	19.60	25.58	19.40	1.12	0.59	27.13	11.56	2.74
1700	15.05	19.56	26.11	18.92	1.12	0.59	27.52	11.85	2.75
1800	14.95	19.57	26.21	18.53	1.13	0.58	27.60	12.00	2.76
2000	14.78	19.59	25.37	18.57	1.14	0.57	27.49	12.01	2.76
2200	14.58	19.65	26.01	17.60	1.15	0.55	27.51	12.13	2.67
2400	14.39	19.68	25.89	17.50	1.17	0.54	27.60	11.77	2.66
2600	14.21	19.70	25.46	17.58	1.18	0.52	27.72	11.59	2.69
2800	13.99	19.77	25.23	17.28	1.20	0.51	28.10	11.90	2.70
3000	13.81	19.82	25.11	17.60	1.22	0.49	28.24	12.21	2.65
3200	13.62	19.88	25.45	17.40	1.24	0.48	28.10	12.30	2.67
3400	13.44	19.94	25.12	17.77	1.27	0.47	28.14	12.22	2.70
3600	13.21	20.10	24.49	17.31	1.30	0.45	27.54	12.13	2.70
3800	13.07	20.13	24.16	17.92	1.32	0.44	27.18	12.20	2.72
4000	12.87	20.26	24.03	17.85	1.36	0.42	26.76	12.23	2.72
4200	12.73	20.26	25.17	18.22	1.37	0.41	26.45	12.13	2.69
4400	12.60	20.33	26.22	18.82	1.40	0.41	26.27	11.92	2.72
4600	12.36	20.45	26.96	18.71	1.44	0.39	25.81	11.82	2.78
4800	12.21	20.64	27.26	18.75	1.48	0.37	25.47	11.94	2.81
5000	12.06	20.56	31.32	19.60	1.50	0.37	25.63	11.72	2.81
5200	11.88	20.71	33.34	19.43	1.54	0.36	25.56	11.46	2.85
5400	11.75	20.84	36.36	19.79	1.58	0.35	25.24	11.32	2.84
5600	11.52	20.86	32.73	19.68	1.62	0.34	24.86	10.98	2.75
5800	11.38	20.95	29.54	20.18	1.66	0.33	24.23	11.10	2.82
6000	11.17	21.07	27.30	19.60	1.71	0.32	24.03	10.96	2.83

MMIC Amplifier

ERA-2SM+

Typical Performance Data

Definitions:

Input Return Loss = -S11 (dB)

Gain(Power Gain) = S21 (dB)

Reverse Isolation = -S12 (dB)

Output Return Loss = -S22 (dB)

TEST CONDITIONS: Icc = 48mA, Vd = 3.67V @Temperature = -45degC

FREQ	Gain	Isolation	Input Return Loss	Output Return Loss	Stability		IP3 Output	1dB Comp. Output	Noise Figure
					K	Delta			
(MHz)	(dB)	(dB)	(dB)	(dB)	K	Delta	(dBm)	(dBm)	(dB)
50	16.53	19.85	35.32	29.48	1.07	0.68	33.10	15.40	2.80
100	16.52	19.86	35.11	28.76	1.07	0.68	33.12	15.31	2.76
200	16.48	19.85	35.30	28.24	1.07	0.68	33.46	15.44	2.74
300	16.44	19.84	34.71	27.42	1.08	0.68	33.30	15.44	2.84
400	16.38	19.82	33.56	26.72	1.08	0.67	33.11	15.39	2.71
500	16.32	19.82	33.36	25.53	1.08	0.67	32.81	15.35	2.74
600	16.25	19.80	31.81	24.62	1.08	0.66	32.74	15.40	2.75
700	16.18	19.79	30.63	23.96	1.08	0.66	32.69	15.37	2.76
800	16.10	19.80	29.84	22.78	1.09	0.65	33.14	15.24	2.77
900	16.02	19.79	28.96	21.62	1.09	0.65	32.82	15.15	2.77
1000	15.94	19.78	28.49	20.88	1.09	0.64	32.77	15.20	2.72
1100	15.85	19.77	27.50	20.25	1.09	0.63	32.90	15.06	2.78
1200	15.77	19.78	27.04	19.90	1.10	0.63	33.03	15.10	2.74
1300	15.69	19.78	26.77	19.44	1.10	0.62	32.71	15.14	2.82
1400	15.59	19.77	26.22	18.83	1.10	0.61	32.79	15.20	2.83
1500	15.50	19.78	25.31	18.57	1.11	0.61	32.99	15.10	2.79
1600	15.40	19.83	24.47	18.22	1.11	0.59	33.23	15.13	2.80
1700	15.31	19.79	25.08	17.86	1.11	0.59	33.78	15.06	2.81
1800	15.21	19.80	24.90	17.51	1.12	0.58	33.41	15.18	2.83
2000	15.03	19.80	24.12	17.60	1.13	0.57	33.11	15.19	2.85
2200	14.83	19.85	24.50	16.76	1.14	0.55	32.91	15.18	2.79
2400	14.63	19.87	24.46	16.72	1.16	0.54	32.24	15.08	2.71
2600	14.44	19.89	24.37	16.84	1.17	0.53	31.63	15.02	2.75
2800	14.22	19.95	24.23	16.61	1.19	0.51	31.42	14.93	2.78
3000	14.03	19.98	24.14	16.97	1.21	0.50	31.21	14.77	2.72
3200	13.84	20.02	24.60	16.78	1.23	0.48	30.71	14.47	2.82
3400	13.64	20.08	24.23	17.19	1.25	0.47	30.56	14.30	2.78
3600	13.41	20.22	23.85	16.80	1.29	0.45	29.71	13.95	2.79
3800	13.26	20.24	23.39	17.41	1.31	0.44	29.00	13.96	2.82
4000	13.06	20.35	23.19	17.39	1.34	0.42	28.52	13.75	2.80
4200	12.91	20.34	23.82	17.73	1.36	0.42	28.19	13.69	2.81
4400	12.78	20.39	24.44	18.30	1.38	0.41	28.03	13.43	2.76
4600	12.54	20.50	24.33	18.22	1.42	0.39	27.49	13.38	2.83
4800	12.38	20.66	24.41	18.32	1.46	0.38	27.18	13.39	2.89
5000	12.23	20.56	25.84	19.08	1.47	0.38	27.27	13.11	2.95
5200	12.05	20.70	26.25	18.94	1.51	0.36	27.29	12.68	2.97
5400	11.91	20.80	26.96	19.30	1.55	0.36	27.01	12.44	2.92
5600	11.68	20.79	26.31	19.14	1.58	0.35	26.58	12.13	2.93
5800	11.54	20.86	25.72	19.62	1.61	0.34	25.82	12.21	2.90
6000	11.32	20.94	24.56	19.10	1.65	0.33	25.54	12.16	3.06

REV. X1
ERA-2SM+
070816
Page 6 of 11



IF/RF MICROWAVE COMPONENTS • ISO 9001 ISO 14001 AS 9100 CERTIFIED • RoHS compliant

P.O. Box 350166, Brooklyn, New York 11235-0003 (718) 934-4500 Fax (718) 332-4661



The Design Engineers Search Engine finds the model you need, Instantly • For detailed performance specs & shopping online see



MMIC Amplifier

ERA-2SM+

Typical Performance Data

Definitions:

Input Return Loss = -S11 (dB)

Gain(Power Gain) = S21 (dB)

Reverse Isolation = -S12 (dB)

Output Return Loss = -S22 (dB)

TEST CONDITIONS: Icc = 40mA, Vd = 3.30V @Temperature = +85degC

FREQ	Gain	Isolation	Input Return Loss	Output Return Loss	Stability		IP3 Output	1dB Comp. Output	Noise Figure
					K	Delta			
(MHz)	(dB)	(dB)	(dB)	(dB)	K	Delta	(dBm)	(dBm)	(dB)
50	16.29	19.68	33.27	31.79	1.08	0.68	29.10	13.61	3.56
100	16.28	19.74	33.77	29.78	1.08	0.67	29.01	13.49	3.54
200	16.22	19.70	34.31	29.09	1.08	0.67	29.38	13.68	3.55
300	16.18	19.70	33.40	28.81	1.08	0.67	29.19	13.63	3.65
400	16.11	19.70	32.80	27.78	1.08	0.66	28.97	13.54	3.57
500	16.05	19.69	32.61	26.51	1.09	0.66	28.73	13.56	3.64
600	15.97	19.68	31.66	25.43	1.09	0.65	28.60	13.58	3.61
700	15.90	19.67	30.64	24.75	1.09	0.65	28.54	13.54	3.64
800	15.82	19.67	29.84	23.81	1.09	0.64	28.96	13.39	3.66
900	15.73	19.68	28.96	22.88	1.10	0.63	28.57	13.27	3.67
1000	15.65	19.67	28.25	22.26	1.10	0.63	28.44	13.37	3.61
1100	15.56	19.67	27.63	21.69	1.10	0.62	28.63	13.19	3.69
1200	15.47	19.67	27.22	21.11	1.11	0.61	28.61	13.24	3.63
1300	15.38	19.66	26.93	20.59	1.11	0.61	28.41	13.30	3.75
1400	15.29	19.68	26.62	20.05	1.12	0.60	28.42	13.24	3.79
1500	15.20	19.68	26.28	19.60	1.12	0.59	28.56	13.29	3.75
1600	15.10	19.70	26.05	19.25	1.13	0.58	28.75	13.15	3.73
1700	15.01	19.70	25.76	18.92	1.13	0.58	29.22	13.18	3.76
1800	14.90	19.71	25.78	18.65	1.14	0.57	29.13	13.24	3.83
2000	14.71	19.74	25.89	18.12	1.15	0.55	28.76	13.28	3.81
2200	14.50	19.77	25.67	17.77	1.17	0.54	28.53	13.23	3.72
2400	14.30	19.82	25.80	17.51	1.18	0.52	28.09	13.02	3.70
2600	14.10	19.87	25.60	17.44	1.20	0.51	27.75	12.85	3.72
2800	13.89	19.91	25.65	17.43	1.22	0.49	27.69	12.85	3.73
3000	13.69	19.98	25.47	17.45	1.25	0.48	27.39	12.69	3.70
3200	13.50	20.04	25.47	17.63	1.27	0.47	27.00	12.40	3.82
3400	13.29	20.13	25.05	17.68	1.30	0.45	26.81	12.10	3.79
3600	13.08	20.24	24.45	17.77	1.33	0.43	25.88	11.76	3.83
3800	12.91	20.32	24.27	17.88	1.36	0.42	25.28	11.75	3.84
4000	12.73	20.41	24.32	17.94	1.39	0.41	24.81	11.62	3.80
4200	12.55	20.45	25.47	18.13	1.42	0.40	24.57	11.57	3.84
4400	12.38	20.51	26.49	18.44	1.45	0.39	24.25	11.12	3.85
4600	12.16	20.73	27.01	18.09	1.50	0.37	23.86	11.06	4.01
4800	11.98	20.82	29.55	18.30	1.54	0.36	23.65	11.13	4.05
5000	11.77	20.95	33.81	18.30	1.59	0.35	23.71	10.83	4.05
5200	11.66	20.97	42.52	19.06	1.61	0.34	23.70	10.39	4.04
5400	11.44	21.08	36.81	18.88	1.66	0.33	23.37	10.07	4.02
5600	11.20	21.12	29.43	19.01	1.71	0.32	22.68	9.70	4.04
5800	11.07	21.51	28.11	18.85	1.79	0.30	22.01	9.87	4.08
6000	10.92	21.64	25.23	19.12	1.84	0.30	21.83	9.78	4.28

REV. X1
ERA-2SM+
070816
Page 7 of 11



IF/RF MICROWAVE COMPONENTS • ISO 9001 ISO 14001 AS 9100 CERTIFIED • RoHS compliant
P.O. Box 350166, Brooklyn, New York 11235-0003 (718) 934-4500 Fax (718) 332-4661



The Design Engineers Search Engine finds the model you need, Instantly • For detailed performance specs & shopping online see



MMIC Amplifier

ERA-2SM+

Typical Performance Data

Definitions:

Input Return Loss = -S11 (dB)

Gain(Power Gain) = S21 (dB)

Reverse Isolation = -S12 (dB)

Output Return Loss = -S22 (dB)

TEST CONDITIONS: Icc = 32mA, Vd = 3.21V @Temperature = +85degC

FREQ	Gain	Isolation	Input Return Loss	Output Return Loss	Stability		IP3 Output	1dB Comp. Output	Noise Figure
					K	Delta			
(MHz)	(dB)	(dB)	(dB)	(dB)	K	Delta	(dBm)	(dBm)	(dB)
50	16.04	19.49	27.40	51.54	1.08	0.67	25.76	11.81	3.48
100	16.02	19.51	27.73	39.08	1.08	0.67	25.66	11.59	3.52
200	15.97	19.49	28.38	36.13	1.08	0.67	25.97	11.90	3.54
300	15.93	19.52	28.33	34.80	1.08	0.66	25.88	11.93	3.62
400	15.87	19.50	28.02	32.16	1.09	0.66	25.69	11.61	3.54
500	15.80	19.50	28.22	30.16	1.09	0.65	25.51	11.85	3.60
600	15.73	19.48	28.16	28.42	1.09	0.65	25.41	11.66	3.60
700	15.65	19.48	27.87	27.25	1.09	0.64	25.39	11.86	3.61
800	15.58	19.48	27.53	25.87	1.10	0.64	25.78	11.72	3.63
900	15.50	19.47	27.26	24.67	1.10	0.63	25.40	11.32	3.63
1000	15.41	19.47	26.91	23.83	1.10	0.62	25.32	11.63	3.55
1100	15.33	19.47	26.71	23.04	1.11	0.62	25.50	11.26	3.67
1200	15.25	19.49	26.47	22.34	1.11	0.61	25.51	11.48	3.59
1300	15.17	19.50	26.35	21.71	1.12	0.60	25.38	11.63	3.74
1400	15.08	19.49	26.15	21.10	1.12	0.60	25.43	11.44	3.74
1500	14.98	19.51	25.91	20.54	1.13	0.59	25.58	11.61	3.71
1600	14.89	19.52	25.91	20.12	1.13	0.58	25.74	11.44	3.71
1700	14.80	19.53	25.63	19.78	1.14	0.58	26.13	11.69	3.73
1800	14.70	19.54	25.68	19.43	1.14	0.57	26.22	11.72	3.79
2000	14.51	19.57	25.89	18.80	1.16	0.55	26.00	11.79	3.75
2200	14.32	19.62	25.63	18.39	1.17	0.54	25.92	11.79	3.70
2400	14.12	19.67	25.65	18.11	1.19	0.52	25.85	11.47	3.65
2600	13.92	19.73	25.31	17.97	1.21	0.51	25.92	11.34	3.70
2800	13.72	19.79	25.27	17.94	1.23	0.49	26.15	11.55	3.70
3000	13.52	19.87	24.95	17.92	1.26	0.48	26.02	11.65	3.69
3200	13.34	19.94	24.80	18.06	1.28	0.46	25.81	11.48	3.75
3400	13.14	20.02	24.30	18.09	1.31	0.45	25.68	11.23	3.74
3600	12.92	20.15	23.85	18.09	1.34	0.43	24.92	10.90	3.77
3800	12.76	20.23	23.61	18.17	1.37	0.42	24.43	10.99	3.79
4000	12.58	20.35	23.59	18.22	1.40	0.41	23.94	11.00	3.76
4200	12.40	20.39	24.66	18.41	1.43	0.40	23.73	10.85	3.81
4400	12.23	20.47	25.56	18.71	1.46	0.39	23.49	10.43	3.80
4600	12.02	20.70	26.30	18.35	1.52	0.37	23.16	10.30	3.93
4800	11.84	20.81	28.50	18.55	1.56	0.36	22.92	10.41	3.99
5000	11.63	20.94	31.88	18.55	1.61	0.34	23.03	10.20	3.95
5200	11.53	20.99	32.15	19.36	1.64	0.34	23.03	9.73	3.98
5400	11.30	21.12	30.48	19.21	1.69	0.33	22.56	9.51	3.97
5600	11.07	21.18	27.22	19.41	1.74	0.32	21.97	9.09	3.90
5800	10.93	21.61	25.94	19.21	1.84	0.30	21.42	9.26	4.01
6000	10.78	21.75	23.47	19.49	1.89	0.29	21.25	9.14	4.18

REV. X1
ERA-2SM+
070816
Page 8 of 11



IF/RF MICROWAVE COMPONENTS • ISO 9001 ISO 14001 AS 9100 CERTIFIED • RoHS compliant

P.O. Box 350166, Brooklyn, New York 11235-0003 (718) 934-4500 Fax (718) 332-4661



The Design Engineers Search Engine finds the model you need, Instantly • For detailed performance specs & shopping online see



MMIC Amplifier

ERA-2SM+

Typical Performance Data

Definitions:

Input Return Loss = -S11 (dB)

Gain(Power Gain) = S21 (dB)

Reverse Isolation = -S12 (dB)

Output Return Loss = -S22 (dB)

TEST CONDITIONS: Icc = 48mA, Vd = 3.38V @Temperature = +85degC

FREQ	Gain	Isolation	Input Return Loss	Output Return Loss	Stability		IP3 Output	1dB Comp. Output	Noise Figure
					K	Delta			
(MHz)	(dB)	(dB)	(dB)	(dB)	K	Delta	(dBm)	(dBm)	(dB)
50	16.45	19.81	38.99	28.11	1.07	0.68	31.85	14.80	3.59
100	16.43	19.83	40.75	26.68	1.08	0.68	31.88	14.79	3.59
200	16.38	19.85	39.53	26.12	1.08	0.67	32.29	14.77	3.59
300	16.33	19.82	37.04	26.06	1.08	0.67	31.87	14.70	3.65
400	16.27	19.83	35.70	25.41	1.08	0.66	31.63	14.72	3.60
500	16.19	19.83	34.26	24.60	1.09	0.66	31.20	14.64	3.71
600	16.12	19.81	32.38	23.79	1.09	0.65	31.00	14.75	3.65
700	16.04	19.80	31.12	23.28	1.09	0.65	30.87	14.59	3.69
800	15.96	19.80	29.99	22.51	1.09	0.64	31.21	14.39	3.71
900	15.87	19.80	28.93	21.78	1.10	0.63	30.80	14.41	3.69
1000	15.79	19.79	28.12	21.28	1.10	0.63	30.53	14.43	3.63
1100	15.70	19.79	27.34	20.77	1.10	0.62	30.57	14.25	3.74
1200	15.61	19.80	26.95	20.25	1.11	0.61	30.49	14.18	3.67
1300	15.52	19.79	26.58	19.83	1.11	0.61	30.15	14.31	3.82
1400	15.42	19.79	26.25	19.39	1.11	0.60	30.09	14.35	3.81
1500	15.33	19.80	25.91	18.99	1.12	0.59	30.17	14.18	3.76
1600	15.23	19.81	25.61	18.67	1.12	0.58	30.32	14.08	3.75
1700	15.13	19.81	25.34	18.39	1.13	0.58	30.56	13.89	3.76
1800	15.03	19.82	25.33	18.16	1.13	0.57	30.11	14.04	3.84
2000	14.83	19.84	25.38	17.65	1.15	0.55	29.71	14.00	3.85
2200	14.62	19.88	25.30	17.36	1.16	0.54	29.21	13.90	3.77
2400	14.41	19.91	25.40	17.15	1.18	0.52	28.48	13.75	3.75
2600	14.21	19.95	25.32	17.08	1.20	0.51	27.85	13.55	3.76
2800	14.00	20.01	25.47	17.10	1.22	0.49	27.56	13.39	3.77
3000	13.79	20.06	25.41	17.16	1.24	0.48	27.20	13.15	3.76
3200	13.60	20.11	25.54	17.34	1.27	0.47	26.82	12.82	3.83
3400	13.39	20.18	25.21	17.44	1.29	0.45	26.52	12.58	3.88
3600	13.18	20.30	24.60	17.53	1.33	0.43	25.71	12.19	3.89
3800	13.00	20.37	24.49	17.66	1.35	0.42	25.08	12.18	3.91
4000	12.82	20.44	24.52	17.75	1.38	0.41	24.63	12.01	3.87
4200	12.64	20.48	25.69	17.94	1.41	0.40	24.47	11.96	3.92
4400	12.47	20.53	26.68	18.25	1.44	0.39	24.25	11.59	3.92
4600	12.24	20.74	26.85	17.94	1.49	0.37	23.86	11.54	4.09
4800	12.06	20.84	29.01	18.14	1.53	0.36	23.57	11.56	4.13
5000	11.86	20.93	31.88	18.12	1.57	0.35	23.54	11.24	4.09
5200	11.74	20.94	40.94	18.86	1.60	0.35	23.58	10.81	4.15
5400	11.52	21.05	36.74	18.67	1.64	0.33	23.30	10.48	4.08
5600	11.29	21.08	29.32	18.75	1.69	0.33	22.62	10.16	4.11
5800	11.15	21.45	28.40	18.63	1.77	0.31	21.91	10.29	4.13
6000	11.01	21.54	25.96	18.88	1.81	0.30	21.69	10.21	4.35

REV. X1
ERA-2SM+
070816
Page 9 of 11



IF/RF MICROWAVE COMPONENTS • ISO 9001 ISO 14001 AS 9100 CERTIFIED • RoHS compliant
P.O. Box 350166, Brooklyn, New York 11235-0003 (718) 934-4500 Fax (718) 332-4661



The Design Engineers Search Engine finds the model you need, Instantly • For detailed performance specs & shopping online see



Typical Performance Curves

GAIN vs. TEMPERATURE

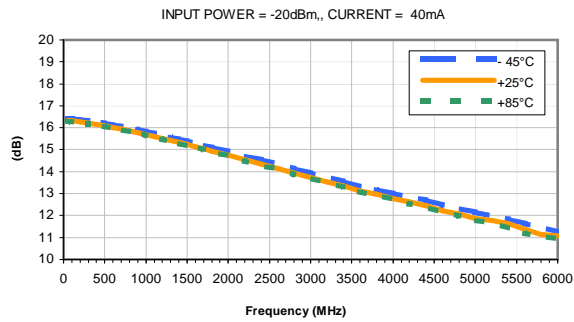

GAIN vs. CURRENT

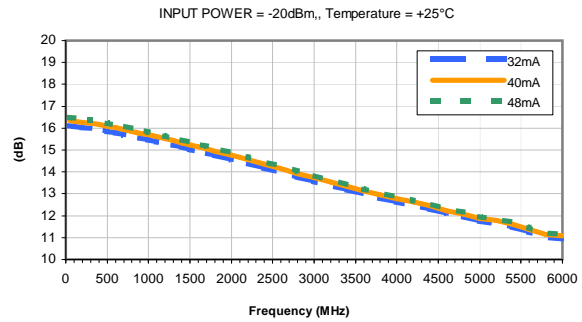

ISOLATION vs. TEMPERATURE

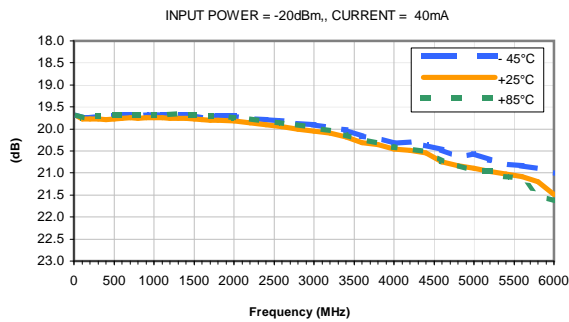

ISOLATION vs. CURRENT

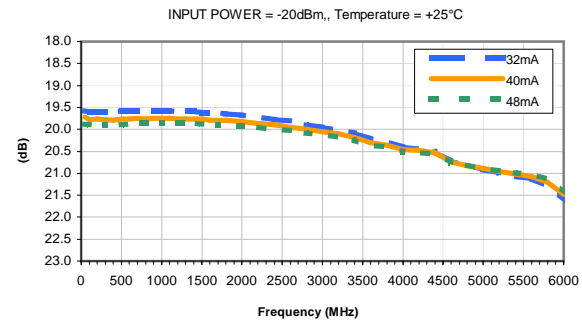

INPUT RETURN LOSS vs. TEMPERATURE

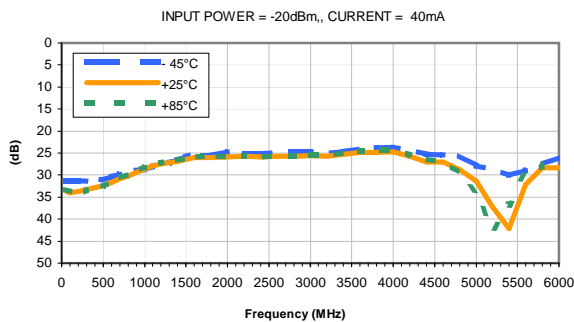

INPUT RETURN LOSS vs. CURRENT

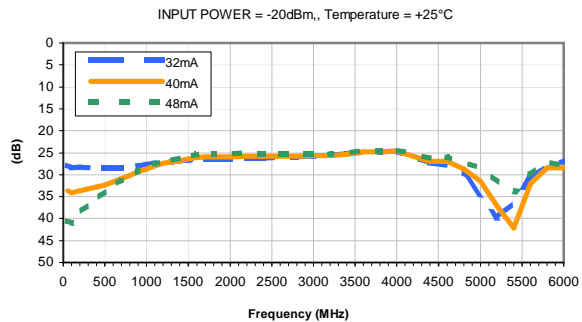

OUTPUT RETURN LOSS vs. TEMPERATURE

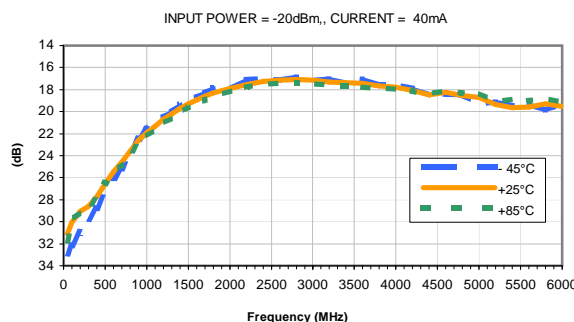

OUTPUT RETURN LOSS vs. CURRENT

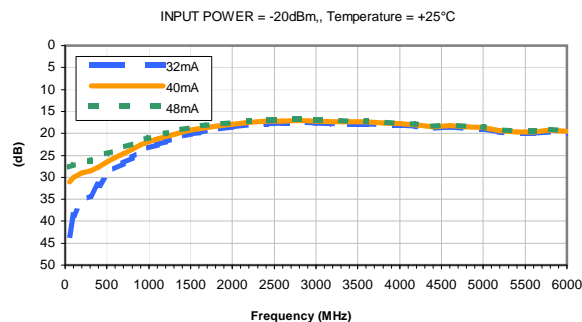

Typical Performance Curves

OUTPUT IP3 vs. TEMPERATURE

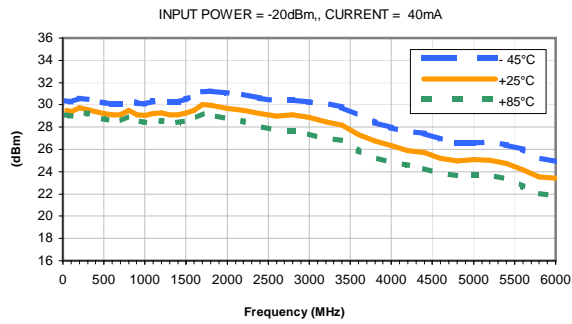

OUTPUT IP3 vs. CURRENT

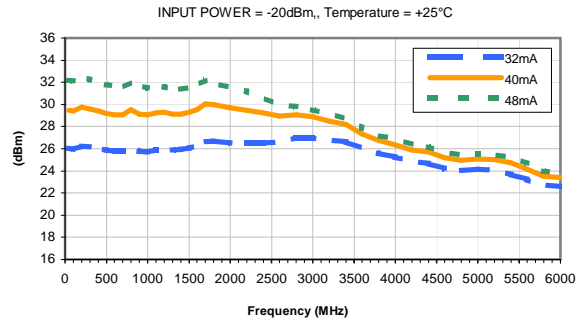

OUTPUT POWER at 1dB Compression vs. TEMPERATURE

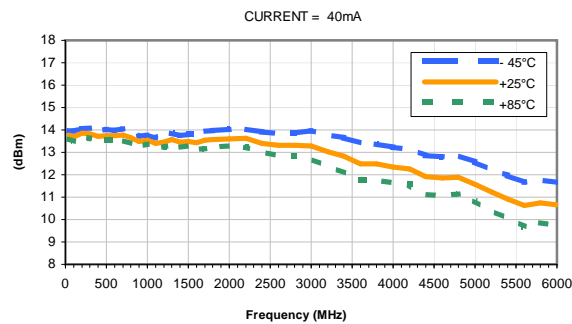

OUTPUT POWER at 1dB Compression vs. CURRENT

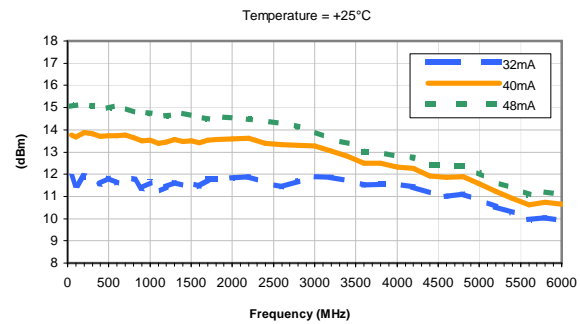

Noise Figure vs. TEMPERATURE

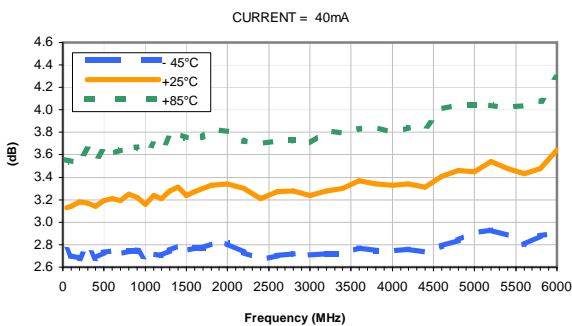

Noise Figure vs. CURRENT

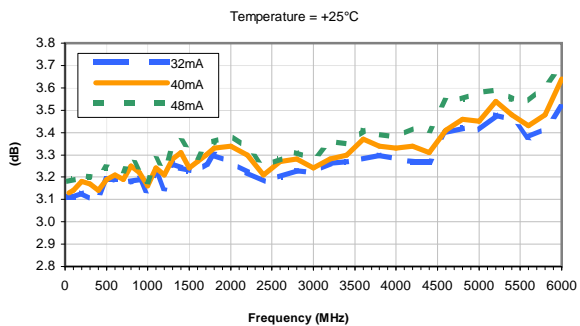

Typical Performance Curves

GAIN vs. TEMPERATURE

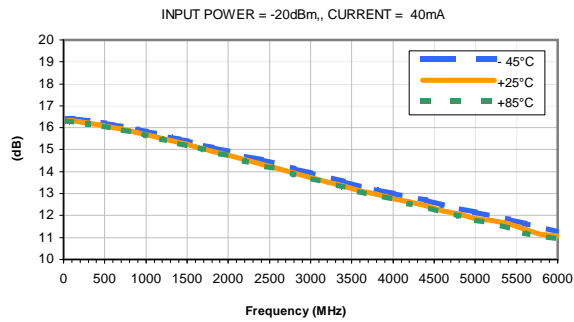

GAIN vs. CURRENT

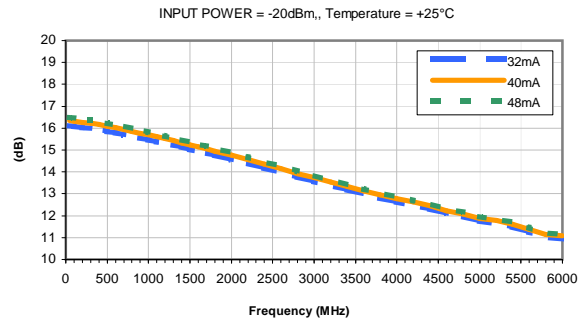

ISOLATION vs. TEMPERATURE

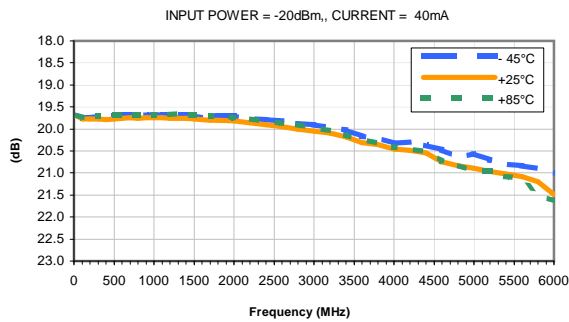

ISOLATION vs. CURRENT

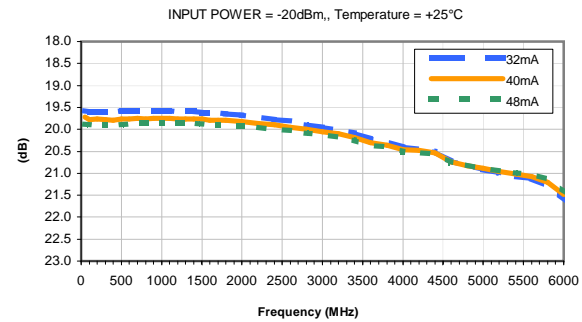

INPUT RETURN LOSS vs. TEMPERATURE

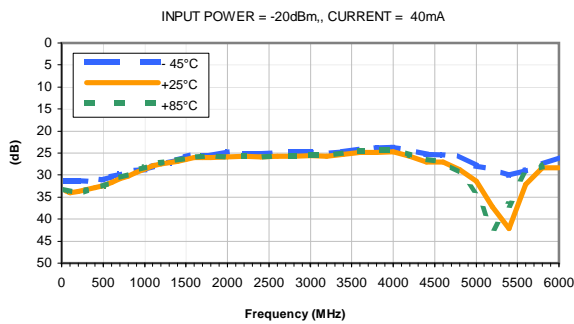

INPUT RETURN LOSS vs. CURRENT

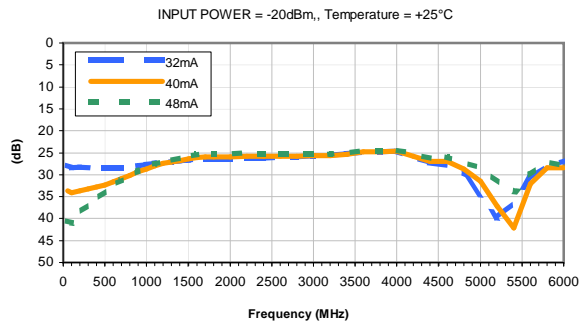

OUTPUT RETURN LOSS vs. TEMPERATURE

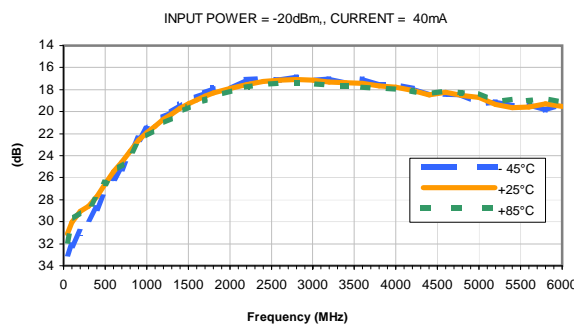

OUTPUT RETURN LOSS vs. CURRENT

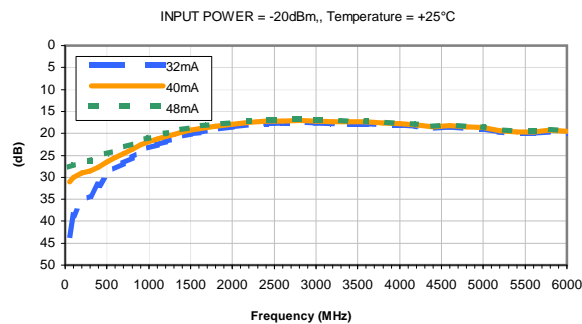

Typical Performance Curves

OUTPUT IP3 vs. TEMPERATURE

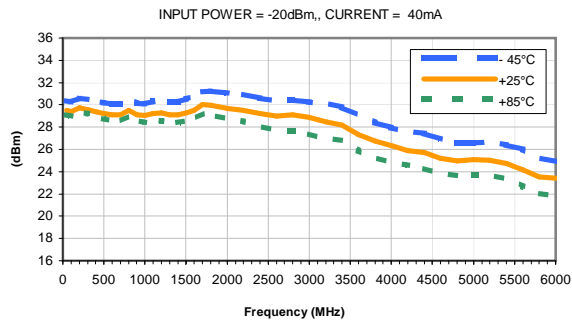

OUTPUT IP3 vs. CURRENT

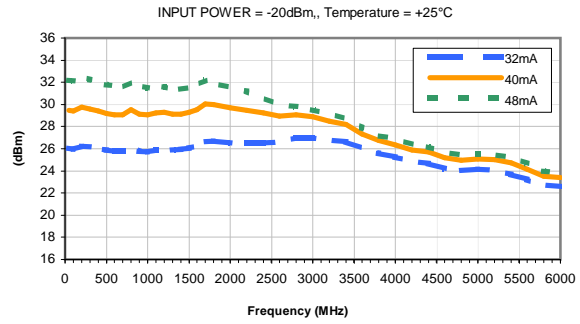

OUTPUT POWER at 1dB Compression vs. TEMPERATURE

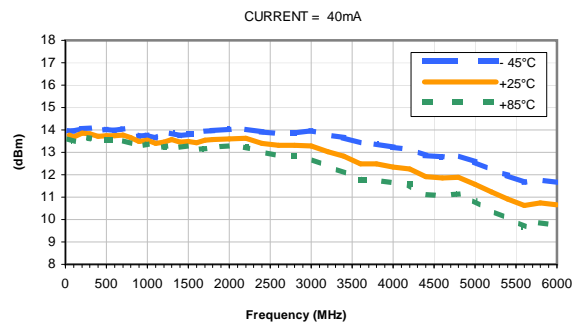

OUTPUT POWER at 1dB Compression vs. CURRENT

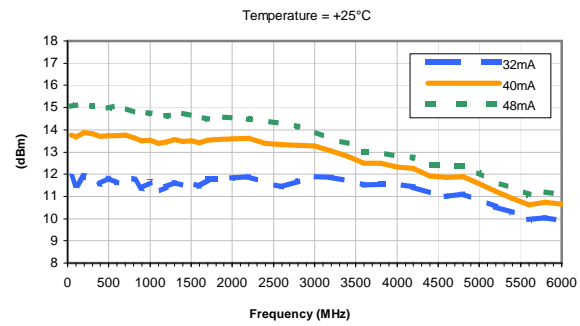

Noise Figure vs. TEMPERATURE

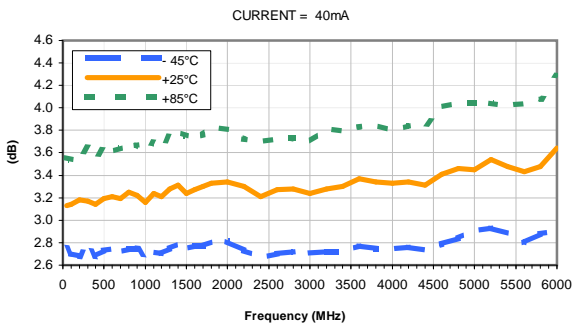

Noise Figure vs. CURRENT

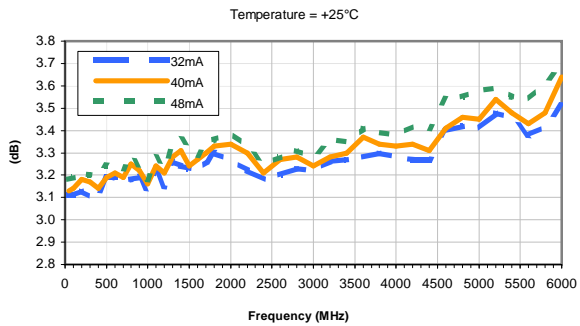

Outline Dimensions

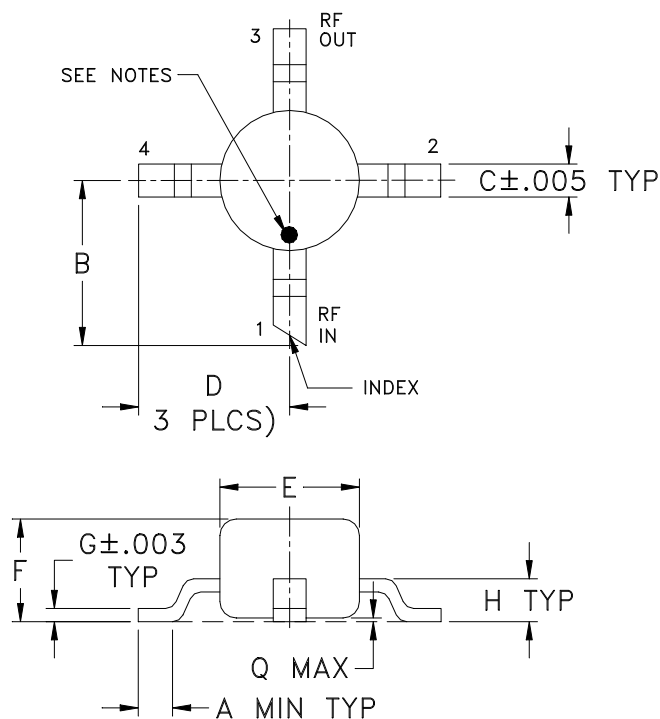

PCB Land Pattern

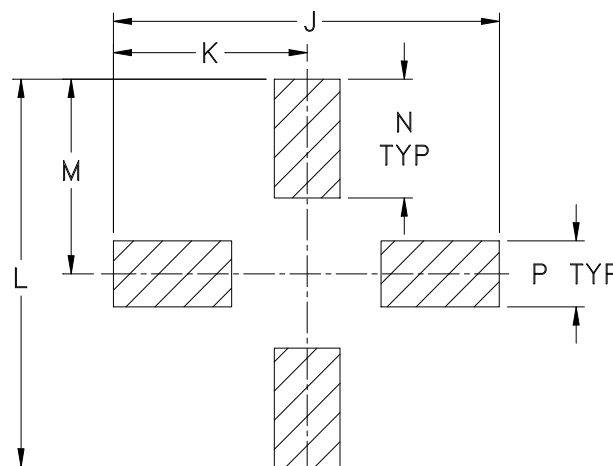

Suggested Layout,
Tolerance to be within $\pm .002$

CASE#	A	B	C	D	E	F	G	H	J	K	L	M	N	P	Q	WT. GRAMS
WW107	.012 (0.30)	.10 (2.54)	.020 (0.51)	.092 (2.34)	.085 (2.16)	.060 (1.52)	.007 (0.18)	.026 (0.66)	.235 (5.97)	.118 (3.00)	.235 (5.97)	.118 (3.00)	.072 (1.83)	.040 (1.02)	.020 (0.51)	.015

Dimensions are in inches (mm). Tolerances: 2 Pl. $\pm .03$; 3 Pl. $\pm .015$

Notes:

- Case material: Plastic.
- Termination finish:
For RoHS Case Styles: Matte tin Plate.
For RoHS-5 Case Styles: Tin-Lead plate.
- RF input termination (1) identified by one or both of the following at factory option:
 - diagonally cut termination, which may be 45° (ref) in either direction;
 - orientation mark on the case. Model dash number is identified by color dot or alphanumeric code on case. See specification data sheet.



INTERNET <http://www.minicircuits.com>

P.O. Box 350166, Brooklyn, New York 11235-0003 (718) 934-4500

Distribution Centers NORTH AMERICA 800-654-7949 • 417-335-5935 • Fax 417-335-5945 • EUROPE 44-1252-1

Mini-Circuits ISO 9001 & ISO 14001 Certified

Tape & Reel Packaging TR-F4

DEVICE ORIENTATION IN T&R

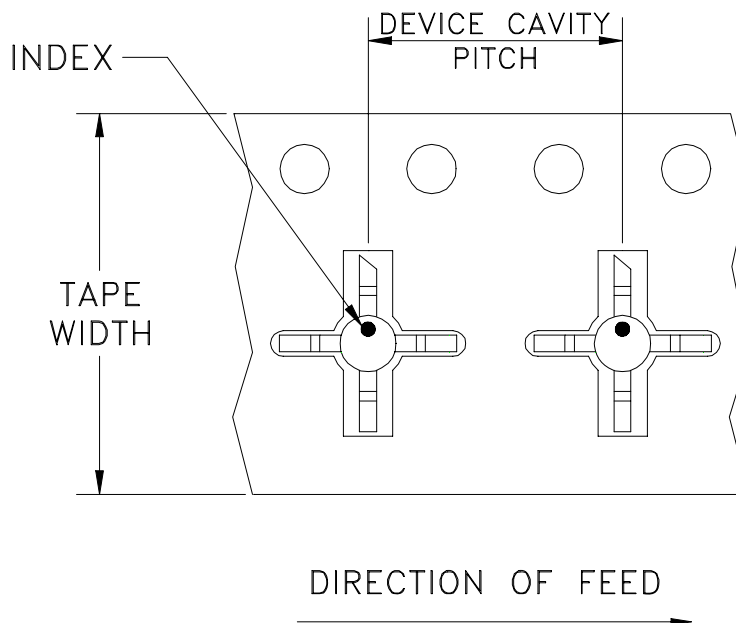

Tape Width, mm	Device Cavity Pitch, mm	Reel Size, inches	Devices per Reel	
12	8	7	Small quantity standards (see note)	20
				50
				100
				200
				500
		7	Standard	1000

Note: Please Consult individual model data sheet to determine device per reel availability.

Mini-Circuits carrier tape materials provide protection from ESD (Electro-Static Discharge) during handling and transportation. Tapes are static dissipative and comply with industry standards EIA-481/EIA-541.

Go to: www.minicircuits.com/pages/pdfs/tape.pdf



INTERNET <http://www.minicircuits.com>

P.O. Box 350166, Brooklyn, New York 11235-0003 (718) 934-4500 Fax (718) 332-4661

Distribution Centers NORTH AMERICA 800-654-7949 • 417-335-5935 • Fax 417-335-5945 • EUROPE 44-1252-832600 • Fax 44-1252-837010

Mini-Circuits ISO 9001 & ISO 14001 Certified

THIRD ANGLE PROJECTION

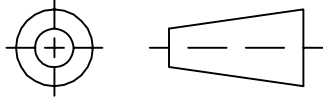

REVISIONS

REV	ECN No.	DESCRIPTION	DATE	DR	AUTH
A	M100215	ADDED "PACKAGE OUTLINE" & UPDATED NOTES	08/12/05	MMG	MM
B	M100944	REMOVED AF190 & UPDATED NOTES	09/23/05	GT	MM
C	M102713	ADDED "...WITH SMOBC"	01/14/06	GF	IL
D	M108434	UPDATED DRAWING PER TB-408+	11/14/06	PW	IG

SUGGESTED MOUNTING CONFIGURATION FOR
WW107 CASE STYLE, "cb" PIN CONNECTION

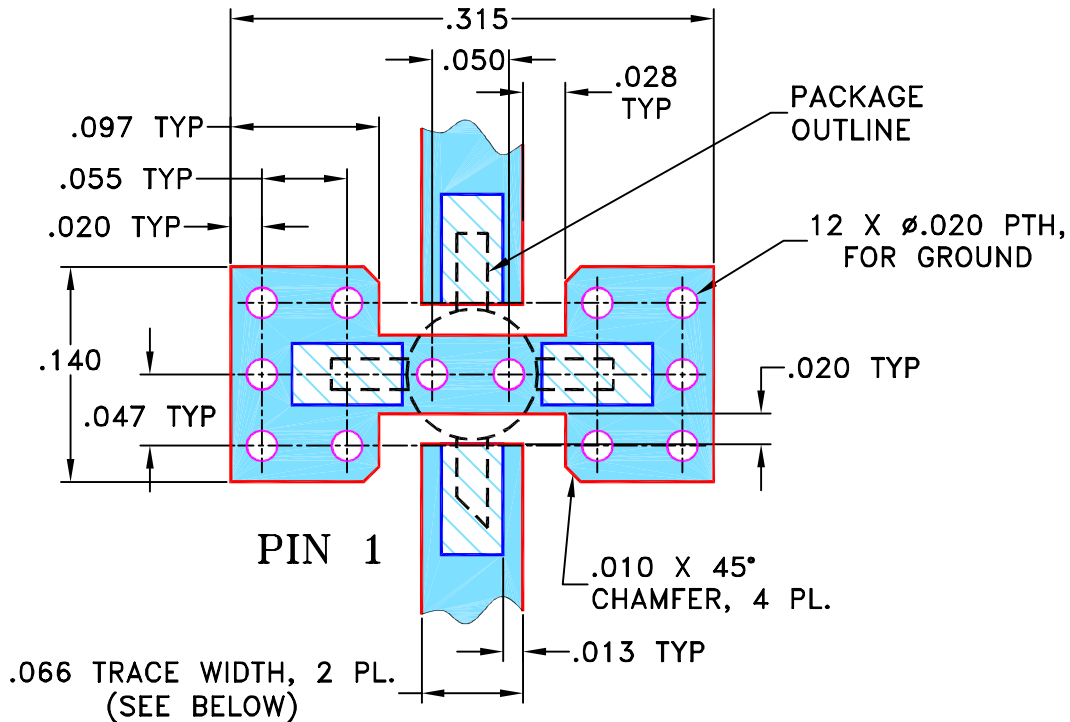

NOTES:

1. TRACE WIDTH IS SHOWN FOR ROGERS R04350B WITH DIELECTRIC THICKNESS .030" ± .002"; COPPER: 1/2 OZ. EACH SIDE. FOR OTHER MATERIALS TRACE WIDTH MAY NEED TO BE MODIFIED.
2. BOTTOM SIDE OF THE PCB IS CONTINUOUS GROUND PLANE.
3. IF PCB DESIGN RULES ALLOW, PLACE GROUND VIAS UNDER THE LAND PATTERN FOR BETTER RF PERFORMANCE. OTHERWISE PLACE GROUND VIAS AS CLOSE TO LAND PATTERN AS POSSIBLE.

- DENOTES PCB COPPER LAYOUT WITH SMOBC (SOLDER MASK OVER BARE COPPER)
- DENOTES COPPER LAND PATTERN FREE OF SOLDER MASK

UNLESS OTHERWISE SPECIFIED	INITIALS	DATE
DIMENSIONS ARE IN INCHES	DRAWN GF	07/18/02
TOLERANCES ON:	CHECKED LC	08/01/02
2 PL DECIMALS ±	APPROVED DJ	08/05/02
3 PL DECIMALS ± .005		
ANGLES ±		
FRACTIONS ±		



Mini-Circuits®

13 Neptune Avenue
Brooklyn NY 11235

PL, cb, WW107, ERA, TB-408-XX+

Mini-Circuits®
THIS DOCUMENT AND ITS CONTENTS ARE THE PROPERTY OF MINI-CIRCUITS. EXCEPT FOR USE EXPRESSLY GRANTED, IN WRITING, TO ITS VENDORS, VENDEE AND THE UNITED STATES GOVERNMENT, MINI-CIRCUITS RESERVES ALL PROPRIETARY DESIGN, USE, MANUFACTURING AND REPRODUCTION RIGHTS THERETO. THESE CONTENTS SHALL NOT BE USED, DUPLICATED OR DISCLOSED TO ANY OUTSIDE PARTY, IN WHOLE OR IN PART, WITHOUT WRITTEN PERMISSION OF MINI-CIRCUITS.

SIZE	CODE IDENT	DRAWING NO:	REV:
A	15542	98-PL-075	D
FILE:	98PL075	SCALE: 8:1	SHEET: 1 OF 1

Evaluation Board and Circuit

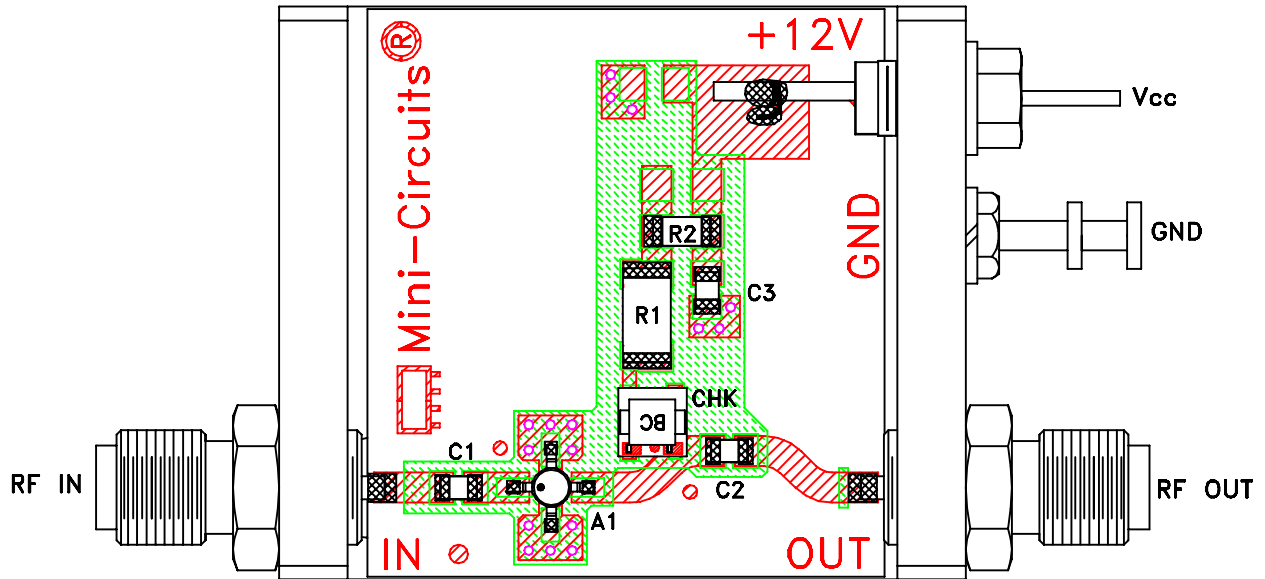

TB-408-2+

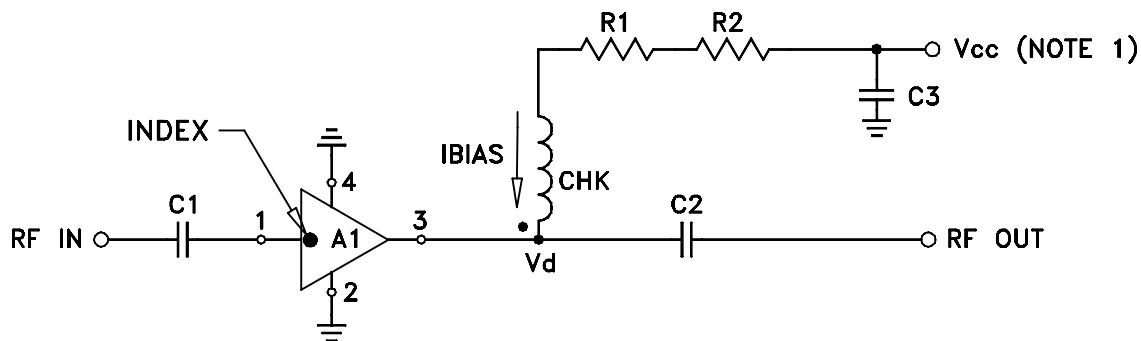

COMPONENT	VALUE
A1	ERA-2SM(+)
C1 (NOTE 4)	2400 pF
C2 (NOTE 4)	2400 pF
C3 (bypass)	0.1 uF
R1	210 Ohms, 0.75W
R2	3.01 Ohms, 0.25W
CHK	Mini-Circuits TCCH-80+

Schematic Diagram

NOTE:

1. Vcc voltage: +12±0.2V.
2. SMA Female connectors.
3. PCB material: Rogers R04350 or equivalent, dielectric constant=3.5, dielectric thickness=.030 inch.
4. Capacitors, C1 & C2 should be free of resonance up to the highest frequency specified.

 **Mini-Circuits®**

All Mini-Circuits products are manufactured under exacting quality assurance and control standards, and are capable of meeting published specifications after being subjected to any or all of the following physical and environmental test.

Specification	Test/Inspection Condition	Reference/Spec
Operating Temperature	-45° to 85°C or -40° to 85°C Ambient Environment	Individual Model Data Sheet
Storage Temperature	-65° to 150° C Ambient Environment	Individual Model Data Sheet
Thermal Shock	-55° to 100°C, 100 cycles	MIL-STD-202, Method 107, Condition A-3, except +100°C
Mechanical Shock	1.5Kg, 0.5 ms, 5 shock pulses, Y1 direction only	MIL-STD-883, Method 2002, Condition B, except Y1 direction only
Vibration (Variable Frequency)	50g peak	MIL-STD-883, Method 2007, Condition B
Autoclave	15 psig, 100% RH, 121°C, 96 hours	JESD22-A102, Condition C
HAST	130°C, 85% RH, 96 hours	JESD22-A110
Solderability	10X Magnification	J-STD-002, Para 4.2.5, Test S, 95% Coverage
Solder Reflow Heat	Sn-Pb Eutetic Process: 240°C peak Pb-Free Process: 260°C peak	J-STD-020, Table 4-1, 4-2 and 5-2; Figure 5-1
Moisture Sensitivity: Level 1	Bake at 125°C for 24 hours Soak at 85°C/85% RH for 168 hours, Reflow 3 cycles at 260°C peak	J-STD-020
Marking Resistance to Solvents	Isopropyl alcohol + mineral spirits at 25°C; terpene defluxer at 25°C; distilled water + proylene glycol monomethyl ether +	MIL-STD-202, Method 215



All Mini-Circuits products are manufactured under exacting quality assurance and control standards, and are capable of meeting published specifications after being subjected to any or all of the following physical and environmental test.

Specification	Test/Inspection Condition	Reference/Spec
	monoethanolamine at 63°C to 70°C	