

Wideband Frequency Mixer

HJK-272MH+

Level 13 (LO Power +13 dBm) 600 to 2700 MHz



Generic photo used for illustration purposes only

CASE STYLE: TTT881

+RoHS Compliant

The +Suffix identifies RoHS Compliance. See our web site for RoHS Compliance methodologies and qualifications



Available Tape and Reel at no extra cost

Reel Size	Devices/Reel
7"	10, 20, 50, 100, 200
13"	500

Maximum Ratings

Operating Temperature	-40°C to 85°C
Storage Temperature	-55°C to 100°C
LO & RF Power	+20 dBm

Permanent damage may occur if any of these limits are exceeded.

Pad Connections

LO	2
RF	1
IF	3
GROUND	4,5,6

Features

- wide band, 600 to 2700 MHz
- good L-R isolation, 37 dB typ.
- protected by US Patent 6,807,407

Applications

- base stations
- communication systems
- cellular
- PCS
- DCS
- radar

Outline Drawing

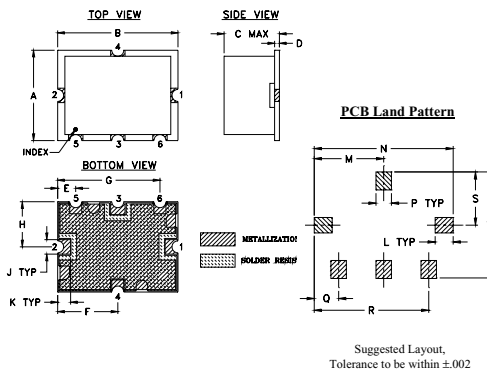

Outline Dimensions (inch)

A	B	C	D	E	F	G	H	J	K
.38	.50	.23	.020	.075	.250	.425	.187	.050	.050
9.65	12.70	5.84	0.51	1.91	6.35	10.80	4.75	1.27	1.27
L	M	N	P	Q	R	S	T	wt.	
.070	.270	.540	.060	.095	.445	.208	.415	grams	
1.78	6.86	13.72	1.52	2.41	11.30	5.28	10.54	0.8	

Demo Board MCL P/N: TB-12 Suggested PCB Layout (PL-079)

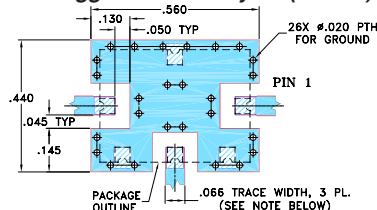

Electrical Specifications at 25°C

Parameter	Min.	Typ.	Max.	Unit
Frequency Range, RF/LO	600	—	2700	MHz
Frequency Range, IF	10	—	1000	MHz
Conversion Loss	—	7.4	9.0	dB
LO to RF Isolation	28	37	—	dB
LO to IF Isolation	20	27	—	dB
IP3	—	21	—	dBm
RF Input Power at 1 dB Compression	—	+16	—	dBm

Typical Performance Data

Frequency (MHz)		Conversion Loss (dB)	Isolation L-R (dB)	Isolation L-I (dB)	VSWR RF Port (:1)	VSWR LO Port (:1)	IP3 (dBm)
RF	LO	LO +13dBm	LO +13dBm	LO +13dBm	LO +13dBm	LO +13dBm	LO +13dBm
597.00	627.00	7.44	37.11	36.89	2.58	4.40	22.10
642.50	672.50	7.28	38.22	36.20	2.43	4.39	22.41
733.50	763.50	7.00	39.37	37.18	2.19	4.23	22.27
824.50	854.50	6.88	53.10	35.57	2.04	4.08	22.12
900.00	930.00	6.83	55.81	31.90	1.96	3.94	22.33
1047.00	1077.00	6.68	50.14	29.64	1.88	3.57	21.18
1120.50	1150.50	6.64	45.95	28.86	1.78	3.38	21.47
1267.50	1297.50	6.68	43.96	28.54	1.70	3.09	21.73
1341.00	1371.00	6.70	44.91	29.03	1.67	3.00	21.54
1414.50	1444.50	6.80	47.05	29.45	1.62	2.97	22.02
1561.50	1591.50	7.09	45.49	30.79	1.62	3.07	23.43
1671.75	1701.75	7.26	48.74	32.45	1.49	3.20	23.21
1745.25	1775.25	7.04	50.07	34.48	1.34	3.31	21.92
1818.75	1848.75	6.94	48.54	36.93	1.23	3.40	21.27
1965.75	1995.75	6.75	43.78	40.52	1.08	3.51	21.23
2039.25	2069.25	6.73	42.71	40.82	1.06	3.51	21.12
2186.25	2216.25	6.73	42.66	37.01	1.14	3.40	20.68
2333.25	2363.25	6.92	57.54	33.28	1.31	3.14	21.18
2640.00	2670.00	7.38	44.82	28.76	1.72	2.71	21.95
2800.00	2830.00	7.83	41.68	28.65	1.94	2.58	21.76

Electrical Schematic

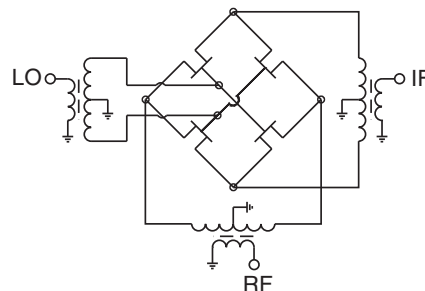

Notes

- A. Performance and quality attributes and conditions not expressly stated in this specification document are intended to be excluded and do not form a part of this specification document.
- B. Electrical specifications and performance data contained in this specification document are based on Mini-Circuit's applicable established test performance criteria and measurement instructions.
- C. The parts covered by this specification document are subject to Mini-Circuits standard limited warranty and terms and conditions (collectively, "Standard Terms"); Purchasers of this part are entitled to the rights and benefits contained therein. For a full statement of the Standard Terms and the exclusive rights and remedies thereunder, please visit Mini-Circuits' website at www.minicircuits.com/MCLStore/terms.jsp



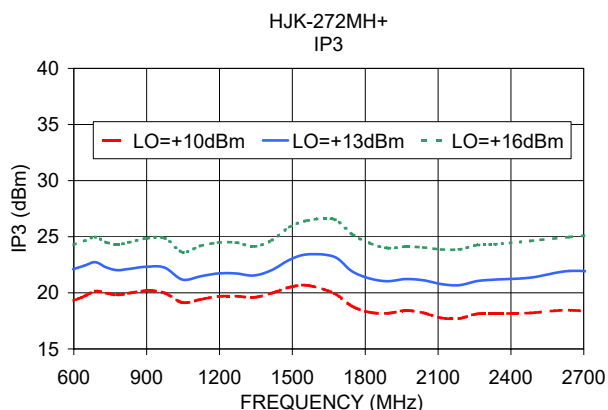
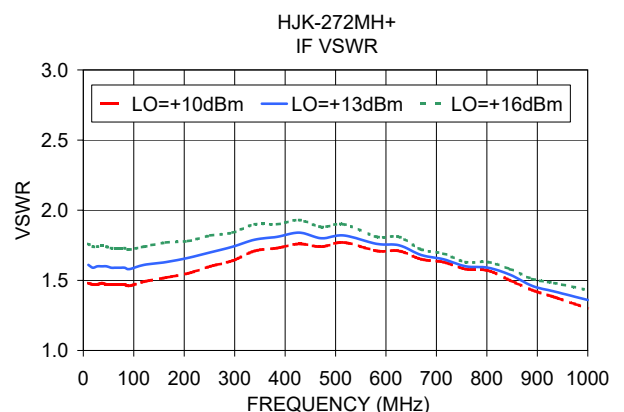
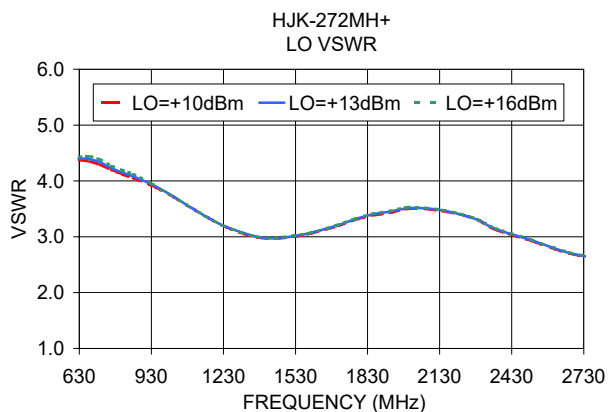
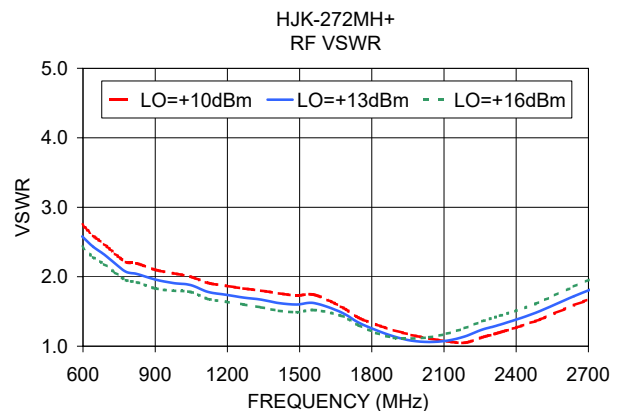
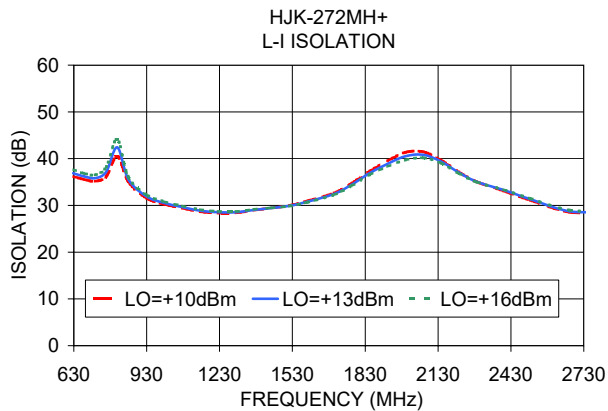
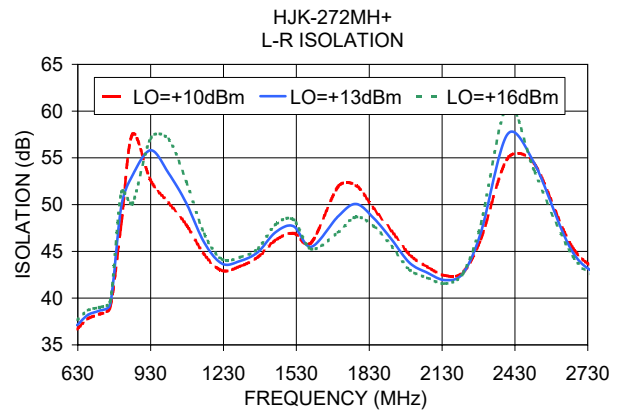
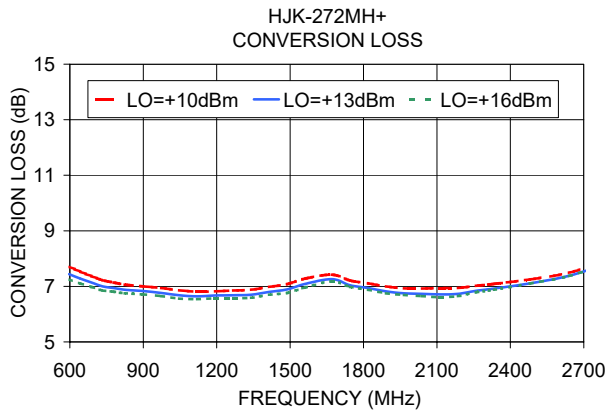

Notes

- A. Performance and quality attributes and conditions not expressly stated in this specification document are intended to be excluded and do not form a part of this specification document.
- B. Electrical specifications and performance data contained in this specification document are based on Mini-Circuit's applicable established test performance criteria and measurement instructions.
- C. The parts covered by this specification document are subject to Mini-Circuits standard limited warranty and terms and conditions (collectively, "Standard Terms"); Purchasers of this part are entitled to the rights and benefits contained therein. For a full statement of the Standard Terms and the exclusive rights and remedies thereunder, please visit Mini-Circuits' website at www.minicircuits.com/MCLStore/terms.jsp

Frequency Mixer

HJK-272MH+

Typical Performance Data

RF (IN) (MHz)	LO (MHz)	CONVERSION LOSS IF FIXED @IF(OUT)=30MHz (dB)			RF (IN) (MHz)	LO (MHz)	IP-3 INPUT (dBm)			RF (IN) (MHz)	LO (MHz)	COMPRESSION @RF IN=+16dBm (dB)		
		@LO (dBm)					@LO (dBm)					@LO (dBm)		
		+10	+13	+16			+10	+13	+16			+10	+13	+16
460.5	490.5	10.13	9.66	9.22	460.5	490.5	15.39	17.74	19.73	460.5	490.5	2.05	1.80	1.43
506.0	536.0	8.61	8.25	8.00	506.0	536.0	17.10	19.55	22.71	506.0	536.0	2.37	1.79	1.16
551.5	581.5	8.03	7.72	7.51	551.5	581.5	17.92	20.93	23.71	551.5	581.5	2.60	1.85	1.12
597.0	627.0	7.71	7.44	7.25	597.0	627.0	19.24	22.05	24.27	597.0	627.0	2.20	1.39	0.77
642.5	672.5	7.53	7.28	7.10	642.5	672.5	19.63	22.41	24.70	642.5	672.5	2.36	1.39	0.73
688.0	718.0	7.37	7.14	6.98	688.0	718.0	20.18	22.81	25.11	688.0	718.0	2.41	1.32	0.63
733.5	763.5	7.22	7.00	6.85	733.5	763.5	20.02	22.40	24.72	733.5	763.5	2.19	1.12	0.49
779.0	809.0	7.14	6.94	6.81	779.0	809.0	19.82	22.09	24.42	779.0	809.0	2.21	1.08	0.45
824.5	854.5	7.06	6.88	6.75	824.5	854.5	19.99	22.23	24.67	824.5	854.5	2.33	1.08	0.42
900.0	930.0	7.00	6.83	6.71	900.0	930.0	20.25	22.48	25.07	900.0	930.0	1.87	0.84	0.34
973.5	1003.5	6.94	6.76	6.65	973.5	1003.5	20.05	22.41	25.10	973.5	1003.5	2.01	0.90	0.39
1047.0	1077.0	6.86	6.68	6.56	1047.0	1077.0	19.21	21.32	23.87	1047.0	1077.0	1.78	0.83	0.36
1120.5	1150.5	6.81	6.64	6.54	1120.5	1150.5	19.50	21.62	24.42	1120.5	1150.5	1.87	0.83	0.38
1194.0	1224.0	6.82	6.67	6.57	1194.0	1224.0	19.74	21.83	24.66	1194.0	1224.0	1.87	0.89	0.41
1267.5	1297.5	6.85	6.68	6.57	1267.5	1297.5	19.80	21.89	24.71	1267.5	1297.5	1.99	0.93	0.43
1341.0	1371.0	6.88	6.70	6.59	1341.0	1371.0	19.70	21.69	24.34	1341.0	1371.0	2.25	1.14	0.54
1414.5	1444.5	6.98	6.80	6.70	1414.5	1444.5	20.07	22.16	24.85	1414.5	1444.5	2.38	1.20	0.57
1488.0	1518.0	7.08	6.89	6.76	1488.0	1518.0	20.64	23.14	26.12	1488.0	1518.0	2.56	1.34	0.64
1561.5	1591.5	7.28	7.09	6.96	1561.5	1591.5	20.86	23.68	26.72	1561.5	1591.5	2.77	1.43	0.67
1671.8	1701.8	7.42	7.26	7.18	1671.8	1701.8	20.01	23.34	26.73	1671.8	1701.8	2.88	1.50	0.66
1745.3	1775.3	7.21	7.04	6.98	1745.3	1775.3	18.83	21.95	25.25	1745.3	1775.3	3.08	1.65	0.75
1818.8	1848.8	7.11	6.94	6.88	1818.8	1848.8	18.25	21.24	24.37	1818.8	1848.8	3.48	1.92	0.87
1892.3	1922.3	7.00	6.82	6.75	1892.3	1922.3	18.17	21.03	24.01	1892.3	1922.3	3.69	2.08	0.97
1965.8	1995.8	6.93	6.75	6.69	1965.8	1995.8	18.40	21.22	24.12	1965.8	1995.8	3.66	2.05	0.96
2039.3	2069.3	6.92	6.73	6.65	2039.3	2069.3	18.16	21.08	24.01	2039.3	2069.3	3.98	2.31	1.11
2112.8	2142.8	6.94	6.71	6.61	2112.8	2142.8	17.61	20.68	24.20	2112.8	2142.8	4.10	2.45	1.21
2186.3	2216.3	6.94	6.73	6.65	2186.3	2216.3	17.65	20.61	23.79	2186.3	2216.3	4.18	2.52	1.28
2259.8	2289.8	7.02	6.84	6.79	2259.8	2289.8	18.07	21.01	24.22	2259.8	2289.8	3.59	2.04	1.01
2333.3	2363.3	7.09	6.92	6.88	2333.3	2363.3	18.12	21.17	24.34	2333.3	2363.3	3.81	2.17	1.04
2480.0	2510.0	7.25	7.11	7.10	2480.0	2510.0	18.14	21.50	24.29	2480.0	2510.0	3.78	2.10	0.96
2640.0	2670.0	7.49	7.38	7.37	2640.0	2670.0	18.42	21.94	25.04	2640.0	2670.0	3.50	1.86	0.84
2800.0	2830.0	7.94	7.83	7.83	2800.0	2830.0	18.05	21.76	25.29	2800.0	2830.0	3.53	1.86	0.82
2960.0	2990.0	8.32	8.21	8.21	2960.0	2990.0	17.78	21.58	25.66	2960.0	2990.0	3.48	1.82	0.78
3120.0	3150.0	8.87	8.75	8.76	3120.0	3150.0	17.03	20.53	25.02	3120.0	3150.0	3.72	2.02	0.89
3280.0	3310.0	9.25	9.05	9.03	3280.0	3310.0	15.76	19.25	23.04	3280.0	3310.0	4.18	2.49	1.18
3440.0	3470.0	9.64	9.36	9.30	3440.0	3470.0	15.24	18.60	22.50	3440.0	3470.0	4.24	2.60	1.28
3600.0	3630.0	10.02	9.65	9.54	3600.0	3630.0	14.61	17.79	21.52	3600.0	3630.0	4.49	2.88	1.48
3760.0	3790.0	10.71	10.18	9.94	3760.0	3790.0	13.84	16.84	20.26	3760.0	3790.0	4.59	3.11	1.71
4000.0	4030.0	11.50	10.83	10.47	4000.0	4030.0	13.59	16.32	19.42	4000.0	4030.0	4.56	3.21	1.87

Frequency Mixer

HJK-272MH+

Typical Performance Data

IF (OUT) (MHz)	LO (MHz)	CONVERSION LOSS VS. IF FREQUENCY @RF(IN)=1650MHz (dB)
		@LO (dBm)
		+13
1196.0	454.0	13.77
1180.8	469.2	11.16
1165.6	484.4	9.75
1150.4	499.6	9.12
1135.2	514.8	8.60
1000.0	650.0	7.87
970.0	680.0	7.86
940.0	710.0	7.81
910.0	740.0	7.87
880.0	770.0	7.89
842.5	807.5	7.99
812.5	837.5	8.11
782.5	867.5	8.09
752.5	897.5	8.00
722.5	927.5	7.96
656.0	994.0	7.63
520.0	1130.0	7.38
384.0	1266.0	7.24
248.0	1402.0	7.43
112.0	1538.0	7.44
10.0	1660.0	7.19
80.0	1730.0	7.39
150.0	1800.0	7.51
220.0	1870.0	7.41
290.0	1940.0	7.29
377.5	2027.5	7.29
447.5	2097.5	7.42
517.5	2167.5	7.41
587.5	2237.5	7.53
657.5	2307.5	7.73
734.0	2384.0	7.96
790.0	2440.0	7.97
846.0	2496.0	8.13
902.0	2552.0	8.25
958.0	2608.0	8.33
1034.5	2684.5	8.49
1132.5	2782.5	8.74
1230.5	2880.5	9.09
1328.5	2978.5	9.49
1426.5	3076.5	9.92

IF (OUT) (MHz)	LO (MHz)	CONVERSION LOSS VS. IF FREQUENCY @RF(IN)=900MHz (dB)
		@LO (dBm)
		+13
10.0	910.0	6.67
44.5	944.5	6.76
79.0	979.0	6.68
113.5	1013.5	6.67
148.0	1048.0	6.78
182.5	1082.5	6.63
217.0	1117.0	6.73
251.5	1151.5	6.74
286.0	1186.0	6.61
320.5	1220.5	6.71
372.3	1272.3	6.56
406.8	1306.8	6.58
441.3	1341.3	6.67
475.8	1375.8	6.61
510.3	1410.3	6.65
544.8	1444.8	6.65
579.3	1479.3	6.50
613.8	1513.8	6.53
648.3	1548.3	6.53
682.8	1582.8	6.46
752.5	1652.5	6.58
777.5	1677.5	6.56
802.5	1702.5	6.60
827.5	1727.5	6.70
852.5	1752.5	6.69
877.5	1777.5	6.68
902.5	1802.5	6.88
927.5	1827.5	6.98
952.5	1852.5	7.03
977.5	1877.5	7.02
1025.0	1925.0	7.24
1075.0	1975.0	7.40
1125.0	2025.0	7.61
1175.0	2075.0	7.81
1225.0	2125.0	7.97
1275.0	2175.0	8.15
1325.0	2225.0	8.27
1375.0	2275.0	8.55
1425.0	2325.0	8.68
1500.0	2400.0	8.94

IF (OUT) (MHz)	LO (MHz)	CONVERSION LOSS VS. IF FREQUENCY @RF(IN)=2400MHz (dB)
		@LO (dBm)
		+13
1500.0	900.0	8.63
1452.0	948.0	8.60
1404.0	996.0	8.42
1356.0	1044.0	8.56
1308.0	1092.0	8.58
1260.0	1140.0	8.83
1212.0	1188.0	8.80
1164.0	1236.0	8.74
1116.0	1284.0	8.50
1068.0	1332.0	8.35
1000.0	1400.0	8.23
985.0	1415.0	8.15
970.0	1430.0	8.12
955.0	1445.0	8.06
940.0	1460.0	8.07
925.0	1475.0	8.02
910.0	1490.0	8.03
895.0	1505.0	7.95
880.0	1520.0	7.91
865.0	1535.0	7.85
842.5	1557.5	7.85
827.5	1572.5	7.88
812.5	1587.5	7.84
797.5	1602.5	7.78
782.5	1617.5	7.69
767.5	1632.5	7.76
752.5	1647.5	7.77
737.5	1662.5	7.82
722.5	1677.5	7.78
707.5	1692.5	7.73
618.0	1782.0	7.66
554.0	1846.0	7.50
490.0	1910.0	7.35
426.0	1974.0	7.39
362.0	2038.0	7.18
298.0	2102.0	7.09
234.0	2166.0	7.21
170.0	2230.0	7.13
106.0	2294.0	7.01
10.0	2390.0	6.86

Frequency Mixer

HJK-272MH+

Typical Performance Data

LO (MHz)	LO-RF ISOLATION (dB)			LO-IF ISOLATION (dB)		
	@LO (dBm)			@LO (dBm)		
	+10	+13	+16	+10	+13	+16
490.5	32.34	32.96	33.57	36.28	37.43	38.60
536.0	34.22	34.68	35.32	36.93	37.85	38.94
581.5	35.93	36.33	36.88	36.78	37.47	38.26
627.0	36.69	37.11	37.65	36.18	36.89	37.64
672.5	37.81	38.22	38.71	35.56	36.20	36.86
718.0	38.28	38.66	39.03	35.17	35.84	36.53
763.5	39.05	39.37	39.66	36.22	37.18	38.19
809.0	47.93	49.81	51.32	40.49	42.42	44.12
854.5	57.50	53.10	50.10	35.05	35.57	36.06
930.0	52.58	55.81	57.09	31.55	31.90	32.27
1003.5	50.20	53.37	57.01	30.23	30.51	30.80
1077.0	47.82	50.14	52.44	29.41	29.64	29.89
1150.5	44.66	45.95	46.86	28.65	28.86	29.09
1224.0	42.95	43.69	44.16	28.36	28.53	28.72
1297.5	43.40	43.96	44.37	28.41	28.54	28.70
1371.0	44.38	44.91	45.27	28.95	29.03	29.14
1444.5	46.19	47.05	47.87	29.45	29.45	29.49
1518.0	46.95	47.69	48.39	29.98	29.90	29.84
1591.5	45.95	45.49	45.25	30.93	30.79	30.67
1701.8	51.91	48.74	47.02	32.63	32.45	32.28
1775.3	52.05	50.07	48.67	34.74	34.48	34.23
1848.8	49.56	48.54	47.68	37.33	36.93	36.56
1922.3	47.17	46.27	45.54	39.52	38.89	38.32
1995.8	44.66	43.78	43.05	41.34	40.52	39.74
2069.3	43.34	42.71	42.17	41.46	40.82	40.17
2142.8	42.41	41.93	41.56	39.66	39.38	39.04
2216.3	42.76	42.66	42.65	37.11	37.01	36.83
2289.8	46.32	47.01	47.94	35.05	35.06	34.97
2400.0	54.94	57.54	60.63	33.11	33.28	33.36
2510.0	54.37	54.43	53.60	31.11	31.32	31.49
2670.0	45.30	44.82	44.41	28.57	28.76	29.01
2830.0	42.20	41.68	41.27	28.56	28.65	28.78
2990.0	40.37	39.75	39.28	29.21	29.27	29.35
3150.0	40.80	39.92	39.24	29.62	29.68	29.74
3310.0	44.23	43.11	42.16	30.15	30.16	30.19
3470.0	47.34	47.17	46.72	29.95	29.91	29.89
3630.0	43.51	43.72	43.84	30.32	30.25	30.20
3790.0	39.85	39.94	40.02	31.30	31.22	31.16
4030.0	34.67	34.56	34.45	30.35	30.34	30.32

RF (IN) (MHz)	LO (MHz)	RF-IF ISOLATION (dB)		
		@LO (dBm)		
		+10	+13	+16
460.5	490.5	21.03	21.06	21.62
506.0	536.0	25.09	25.75	26.27
551.5	581.5	27.38	27.93	28.40
597.0	627.0	29.27	29.89	30.26
642.5	672.5	30.51	30.90	31.17
688.0	718.0	32.48	32.67	32.76
733.5	763.5	34.16	34.34	34.64
779.0	809.0	35.38	35.43	35.53
824.5	854.5	32.70	32.56	32.68
900.0	930.0	34.13	33.96	34.14
973.5	1003.5	34.57	34.59	34.94
1047.0	1077.0	34.20	34.15	34.43
1120.5	1150.5	34.15	34.15	34.62
1194.0	1224.0	33.78	33.79	33.94
1267.5	1297.5	33.83	33.98	34.51
1341.0	1371.0	32.99	33.09	33.35
1414.5	1444.5	32.28	32.47	32.87
1488.0	1518.0	31.44	31.64	32.02
1561.5	1591.5	30.66	30.95	31.37
1671.8	1701.8	33.08	33.00	32.99
1745.3	1775.3	34.28	33.46	32.83
1818.8	1848.8	34.15	33.19	32.43
1892.3	1922.3	33.62	32.73	31.96
1965.8	1995.8	33.10	32.46	31.80
2039.3	2069.3	33.22	32.78	32.29
2112.8	2142.8	32.89	32.62	32.30
2186.3	2216.3	32.63	32.41	32.19
2259.8	2289.8	32.74	32.56	32.36
2333.3	2363.3	33.49	33.44	33.34
2480.0	2510.0	35.15	35.58	35.78
2640.0	2670.0	34.51	34.96	35.29
2800.0	2830.0	36.31	36.72	36.93
2960.0	2990.0	37.76	38.27	38.58
3120.0	3150.0	40.04	40.46	40.67
3280.0	3310.0	41.24	41.35	41.23
3440.0	3470.0	39.69	39.27	38.82
3600.0	3630.0	36.64	36.18	35.74
3760.0	3790.0	33.74	33.35	32.97
4000.0	4030.0	29.97	29.80	29.60

Frequency Mixer

HJK-272MH+

Typical Performance Data

RF (IN) (MHz)	LO (MHz)	RF VSWR (:1)			LO (MHz)	LO VSWR (:1)			IF (OUT) (MHz)	IF VSWR @LO=2400MHz (:1)		
		@LO (dBm)				@LO (dBm)				@LO (dBm)		
		+10	+13	+16		+10	+13	+16		+10	+13	+16
460.5	490.5	3.48	3.31	3.16	490.5	4.25	4.25	4.24	10.0	1.48	1.61	1.76
506.0	536.0	3.18	3.01	2.84	536.0	4.35	4.36	4.35	19.0	1.47	1.59	1.74
551.5	581.5	2.97	2.80	2.64	581.5	4.38	4.39	4.40	28.0	1.47	1.60	1.74
597.0	627.0	2.75	2.58	2.43	627.0	4.38	4.40	4.43	37.0	1.48	1.60	1.75
642.5	672.5	2.59	2.43	2.28	672.5	4.35	4.39	4.44	46.0	1.47	1.60	1.74
688.0	718.0	2.47	2.32	2.18	718.0	4.29	4.33	4.38	55.0	1.47	1.59	1.73
733.5	763.5	2.33	2.19	2.06	763.5	4.20	4.23	4.27	64.0	1.47	1.59	1.73
779.0	809.0	2.21	2.07	1.95	809.0	4.12	4.15	4.19	73.0	1.47	1.59	1.73
824.5	854.5	2.19	2.04	1.92	854.5	4.05	4.08	4.12	82.0	1.47	1.59	1.73
900.0	930.0	2.10	1.96	1.83	930.0	3.92	3.94	3.96	91.0	1.46	1.58	1.72
973.5	1003.5	2.05	1.91	1.80	1003.5	3.76	3.77	3.77	120.0	1.49	1.61	1.74
1047.0	1077.0	2.00	1.88	1.78	1077.0	3.57	3.57	3.57	164.0	1.52	1.63	1.77
1120.5	1150.5	1.91	1.78	1.68	1150.5	3.38	3.38	3.38	208.0	1.55	1.66	1.78
1194.0	1224.0	1.87	1.74	1.64	1224.0	3.21	3.21	3.21	252.0	1.60	1.70	1.82
1267.5	1297.5	1.83	1.70	1.60	1297.5	3.08	3.09	3.09	296.0	1.64	1.74	1.84
1341.0	1371.0	1.80	1.67	1.56	1371.0	2.99	3.00	3.00	340.0	1.71	1.79	1.90
1414.5	1444.5	1.76	1.62	1.51	1444.5	2.97	2.97	2.98	384.0	1.73	1.81	1.90
1488.0	1518.0	1.73	1.60	1.49	1518.0	3.00	3.01	3.02	428.0	1.76	1.84	1.93
1561.5	1591.5	1.74	1.62	1.52	1591.5	3.06	3.07	3.07	472.0	1.74	1.80	1.88
1671.8	1701.8	1.57	1.49	1.44	1701.8	3.19	3.20	3.21	516.0	1.77	1.82	1.90
1745.3	1775.3	1.41	1.34	1.30	1775.3	3.30	3.31	3.32	582.0	1.71	1.76	1.81
1818.8	1848.8	1.31	1.23	1.19	1848.8	3.38	3.40	3.41	626.0	1.71	1.75	1.81
1892.3	1922.3	1.23	1.14	1.12	1922.3	3.43	3.45	3.46	670.0	1.65	1.68	1.72
1965.8	1995.8	1.16	1.08	1.11	1995.8	3.50	3.51	3.53	714.0	1.63	1.65	1.69
2039.3	2069.3	1.11	1.06	1.13	2069.3	3.50	3.51	3.52	758.0	1.58	1.60	1.63
2112.8	2142.8	1.07	1.08	1.18	2142.8	3.46	3.47	3.48	802.0	1.57	1.59	1.63
2186.3	2216.3	1.05	1.14	1.26	2216.3	3.40	3.40	3.41	846.0	1.50	1.54	1.58
2259.8	2289.8	1.13	1.24	1.36	2289.8	3.30	3.30	3.31	890.0	1.43	1.46	1.51
2333.3	2363.3	1.20	1.31	1.44	2400.0	3.13	3.14	3.15	934.0	1.38	1.42	1.48
2480.0	2510.0	1.36	1.48	1.61	2510.0	2.93	2.94	2.95	1000.0	1.30	1.36	1.43
2640.0	2670.0	1.59	1.72	1.86	2670.0	2.70	2.71	2.72	1082.0	1.29	1.38	1.47
2800.0	2830.0	1.80	1.94	2.09	2830.0	2.58	2.58	2.59	1126.0	1.33	1.43	1.52
2960.0	2990.0	2.07	2.22	2.38	2990.0	2.61	2.62	2.63	1170.0	1.38	1.48	1.59
3120.0	3150.0	2.30	2.46	2.63	3150.0	2.72	2.72	2.73	1214.0	1.45	1.56	1.67
3280.0	3310.0	2.52	2.66	2.82	3310.0	2.79	2.79	2.79	1258.0	1.58	1.70	1.82
3440.0	3470.0	2.80	2.91	3.05	3470.0	2.88	2.88	2.89	1302.0	1.67	1.79	1.92
3600.0	3630.0	3.12	3.17	3.26	3630.0	2.93	2.93	2.93	1346.0	1.81	1.94	2.09
3760.0	3790.0	3.41	3.39	3.40	3790.0	2.99	2.99	2.99	1390.0	1.92	2.07	2.22
4000.0	4030.0	3.76	3.64	3.53	4030.0	3.08	3.09	3.09	1500.0	2.29	2.46	2.63

Harmonics Tables

RF HARMONICS ORDER

	(-dBm)	(-dBc)										
0	---	---	11.27	30.84	29.87	39.16	30.70	44.66	31.34	55.71	59.09	63.26
1	---	25.48	---	28.32	25.18	32.22	49.11	45.71	48.86	51.05	50.55	71.62
2	91.96	63.94	47.48	46.84	50.11	63.56	60.30	61.66	57.81	64.97	55.65	67.81
3	111.81	70.83	63.70	77.46	54.09	65.35	68.12	69.53	79.05	71.57	81.88	78.02
4	111.46	90.25	95.22	102.93	79.02	85.04	80.04	96.34	90.27	91.72	87.72	84.13
5	113.76	102.10	93.85	102.19	87.08	85.94	75.10	87.26	87.24	93.69	101.06	99.21
6	110.13	101.80	100.81	102.41	94.80	100.29	87.93	88.77	92.12	98.58	103.46	100.20
7	110.24	101.52	102.33	100.59	102.05	102.93	103.51	98.93	93.70	99.45	103.03	102.08
8	111.86	100.69	101.33	102.49	102.52	102.26	102.08	102.18	101.39	102.82	101.97	102.92
9	110.51	98.14	101.43	102.07	102.19	100.55	101.99	102.46	102.78	101.93	101.13	102.78
10	106.87	99.64	99.41	100.94	102.91	103.06	103.50	102.88	102.62	102.36	87.36	101.80
	RF CAL	0	1	2	3	4	5	6	7	8	9	10

LO HARMONICS ORDER

Test conditions: RF IN: 1650 MHz; 0.00 dBm.
 LO IN: 1680 MHz; +13.00 dBm
 IF OUT: 30 MHz; -7.41 dBm

RF HARMONICS ORDER

	(-dBm)	(-dBc)										
0	---	---	17.98	39.12	37.75	47.29	39.94	74.08	45.80	52.83	66.72	72.46
1	---	25.07	---	29.83	26.93	36.28	49.32	48.45	50.66	60.49	50.24	86.29
2	89.04	58.04	36.07	36.82	39.54	52.42	49.40	54.60	51.56	67.76	58.70	65.73
3	98.12	51.48	44.79	55.32	33.78	50.70	47.27	57.45	67.84	63.82	69.01	67.13
4	98.65	71.16	61.15	67.77	52.79	56.36	56.39	65.54	64.48	68.02	64.43	73.19
5	100.24	73.88	72.76	71.91	68.83	75.83	58.74	66.31	69.63	70.91	81.14	69.81
6	101.05	82.42	79.10	82.09	74.57	80.56	63.61	71.61	60.76	77.34	72.92	88.74
7	99.94	88.28	85.38	83.98	81.07	84.63	75.99	76.93	67.14	84.27	80.31	82.16
8	99.65	94.23	101.27	90.81	94.02	92.31	84.66	101.34	72.80	90.32	69.81	91.24
9	98.09	104.02	96.29	93.79	90.47	101.22	88.46	104.85	80.85	83.85	71.76	82.75
10	99.00	112.11	108.91	98.01	97.33	99.62	99.67	106.76	90.98	101.68	80.87	92.77
	RF CAL	0	1	2	3	4	5	6	7	8	9	10

LO HARMONICS ORDER

Test conditions: RF IN: 1650 MHz; 10.00 dBm.
 LO IN: 1680 MHz; +13.00 dBm
 IF OUT: 30 MHz; 2.40 dBm

- Notes:
1. All Harmonics are in (dBc) relative to IF OUTPUT
 2. + entry denotes harmonics are in (dBc) above IF OUTPUT
 3. RF Cal represents the Harmonics level of the RF Input Signal to the mixer

Frequency Mixer

Typical Performance Curves

HJK-272MH+

Conversion Loss @IF=30 MHz

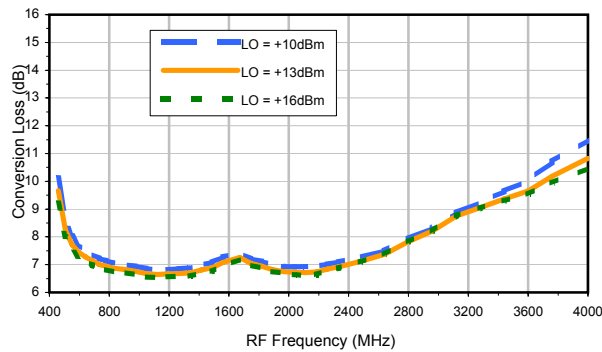

Conversion Loss vs. LO @ RF=1650 MHz

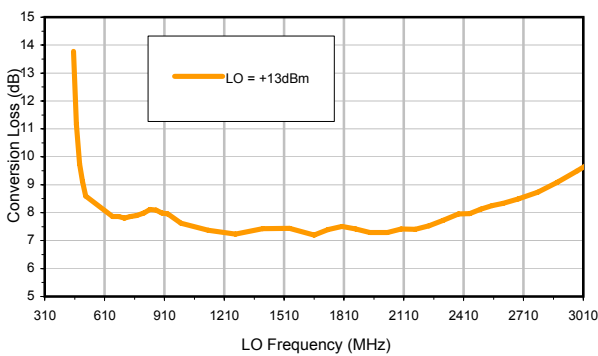

Conversion Loss vs. IF @ RF=1650 MHz

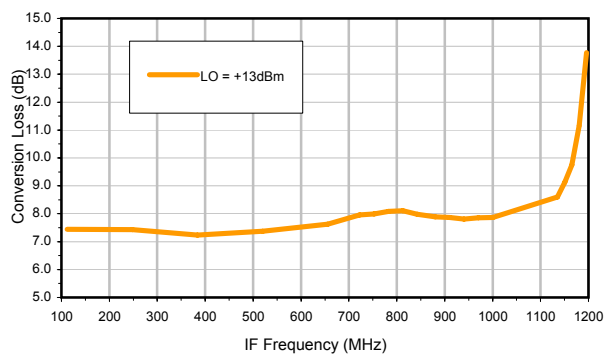

Conversion Loss vs. IF @ RF=900 MHz

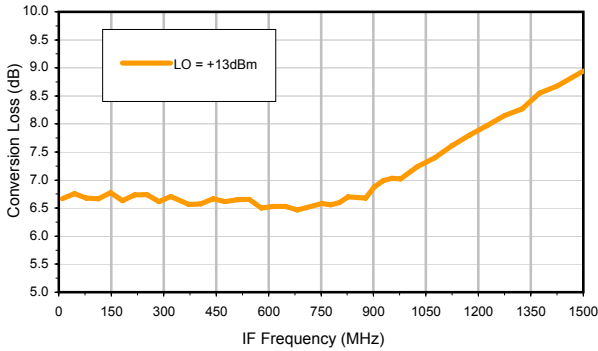

Conversion Loss vs. IF @ RF=2400 MHz

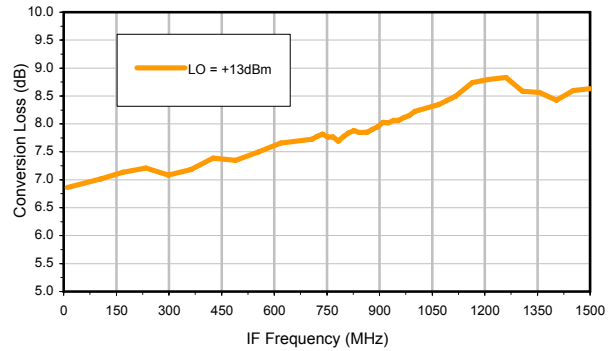

IP-3 Input

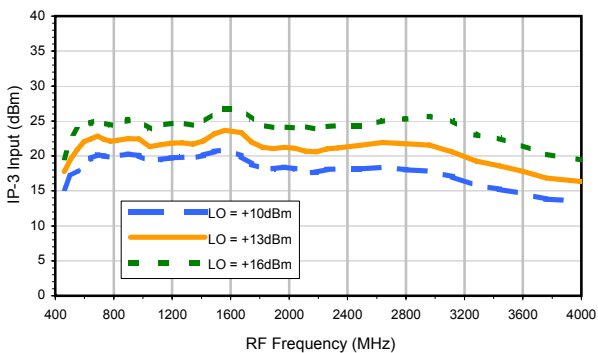

Compression @RF IN=+16 dBm

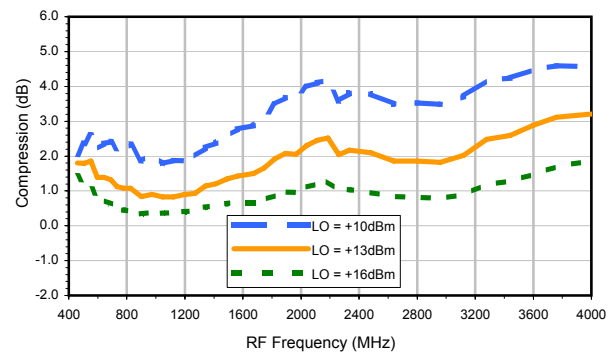

Frequency Mixer

HJK-272MH+

Typical Performance Curves

LO-RF Isolation

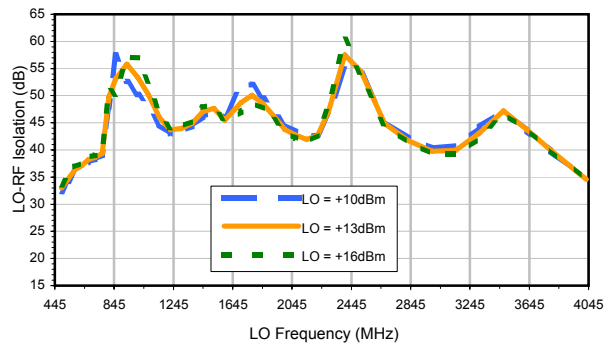

LO-IF Isolation

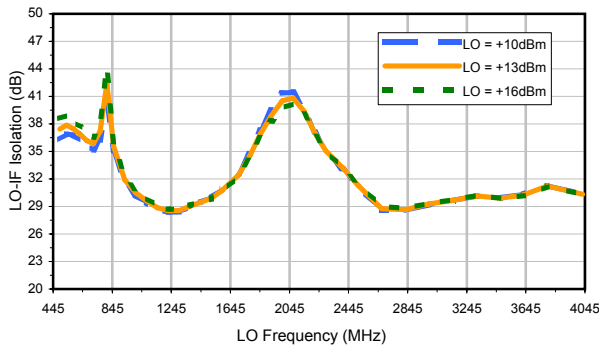

RF-IF Isolation

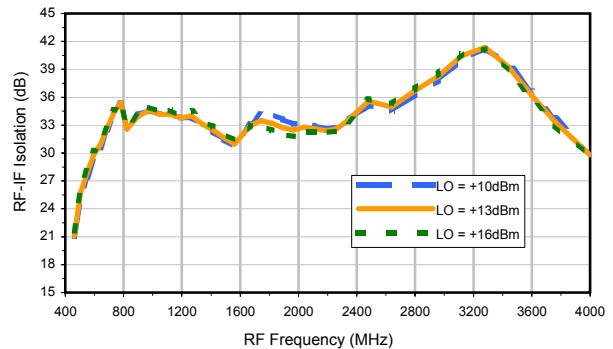

RF VSWR

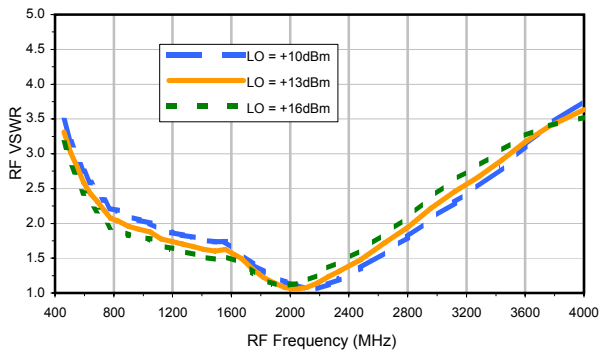

LO VSWR

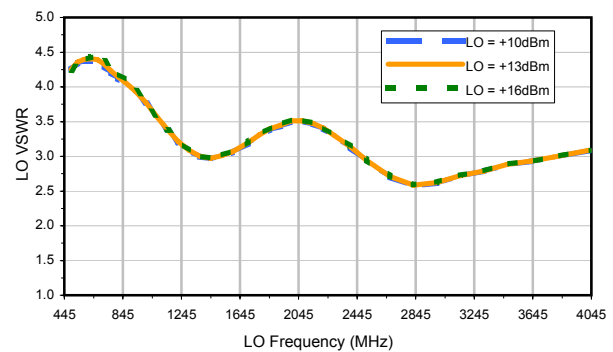

IF VSWR

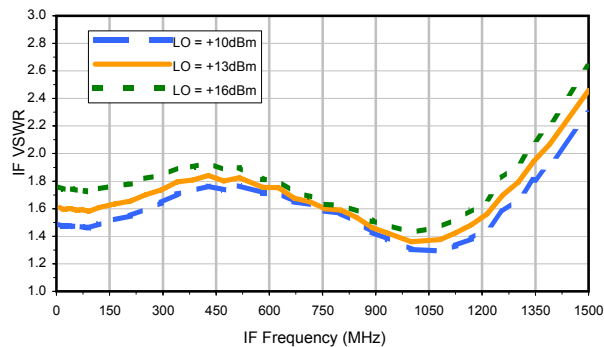

Harmonics Tables

RF HARMONICS ORDER

	(-dBm)	(-dBc)										
0	---	---	11.27	30.84	29.87	39.16	30.70	44.66	31.34	55.71	59.09	63.26
1	---	25.48	---	28.32	25.18	32.22	49.11	45.71	48.86	51.05	50.55	71.62
2	91.96	63.94	47.48	46.84	50.11	63.56	60.30	61.66	57.81	64.97	55.65	67.81
3	111.81	70.83	63.70	77.46	54.09	65.35	68.12	69.53	79.05	71.57	81.88	78.02
4	111.46	90.25	95.22	102.93	79.02	85.04	80.04	96.34	90.27	91.72	87.72	84.13
5	113.76	102.10	93.85	102.19	87.08	85.94	75.10	87.26	87.24	93.69	101.06	99.21
6	110.13	101.80	100.81	102.41	94.80	100.29	87.93	88.77	92.12	98.58	103.46	100.20
7	110.24	101.52	102.33	100.59	102.05	102.93	103.51	98.93	93.70	99.45	103.03	102.08
8	111.86	100.69	101.33	102.49	102.52	102.26	102.08	102.18	101.39	102.82	101.97	102.92
9	110.51	98.14	101.43	102.07	102.19	100.55	101.99	102.46	102.78	101.93	101.13	102.78
10	106.87	99.64	99.41	100.94	102.91	103.06	103.50	102.88	102.62	102.36	87.36	101.80
	RF CAL	0	1	2	3	4	5	6	7	8	9	10

LO HARMONICS ORDER

Test conditions: RF IN: 1650 MHz; 0.00 dBm.
 LO IN: 1680 MHz; +13.00 dBm
 IF OUT: 30 MHz; -7.41 dBm

RF HARMONICS ORDER

	(-dBm)	(-dBc)										
0	---	---	17.98	39.12	37.75	47.29	39.94	74.08	45.80	52.83	66.72	72.46
1	---	25.07	---	29.83	26.93	36.28	49.32	48.45	50.66	60.49	50.24	86.29
2	89.04	58.04	36.07	36.82	39.54	52.42	49.40	54.60	51.56	67.76	58.70	65.73
3	98.12	51.48	44.79	55.32	33.78	50.70	47.27	57.45	67.84	63.82	69.01	67.13
4	98.65	71.16	61.15	67.77	52.79	56.36	56.39	65.54	64.48	68.02	64.43	73.19
5	100.24	73.88	72.76	71.91	68.83	75.83	58.74	66.31	69.63	70.91	81.14	69.81
6	101.05	82.42	79.10	82.09	74.57	80.56	63.61	71.61	60.76	77.34	72.92	88.74
7	99.94	88.28	85.38	83.98	81.07	84.63	75.99	76.93	67.14	84.27	80.31	82.16
8	99.65	94.23	101.27	90.81	94.02	92.31	84.66	101.34	72.80	90.32	69.81	91.24
9	98.09	104.02	96.29	93.79	90.47	101.22	88.46	104.85	80.85	83.85	71.76	82.75
10	99.00	112.11	108.91	98.01	97.33	99.62	99.67	106.76	90.98	101.68	80.87	92.77
	RF CAL	0	1	2	3	4	5	6	7	8	9	10

LO HARMONICS ORDER

Test conditions: RF IN: 1650 MHz; 10.00 dBm.
 LO IN: 1680 MHz; +13.00 dBm
 IF OUT: 30 MHz; 2.40 dBm

- Notes:
1. All Harmonics are in (dBc) relative to IF OUTPUT
 2. + entry denotes harmonics are in (dBc) above IF OUTPUT
 3. RF Cal represents the Harmonics level of the RF Input Signal to the mixer

Outline Dimensions

TTT881

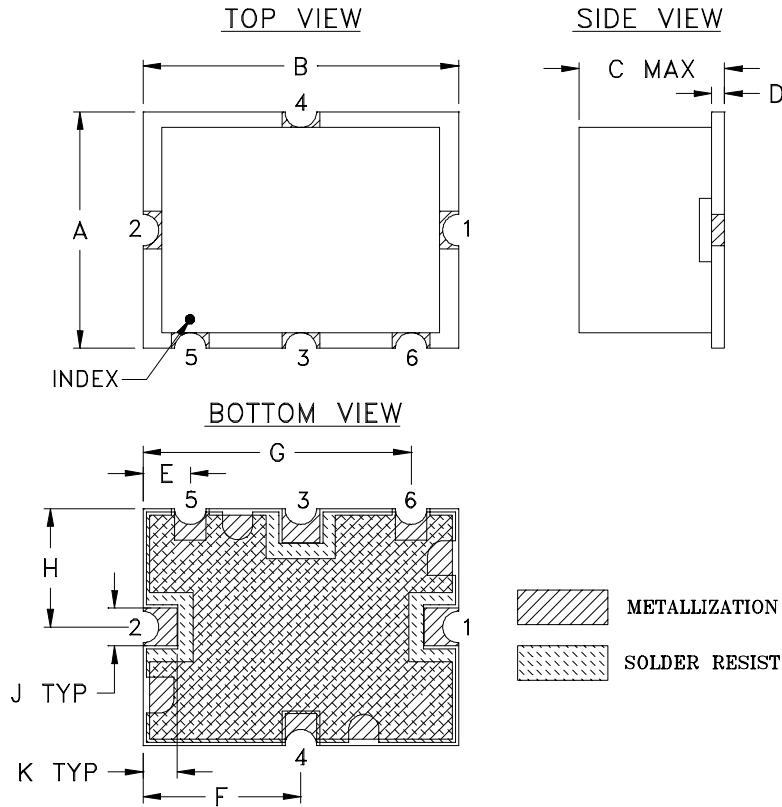

PCB Land Pattern

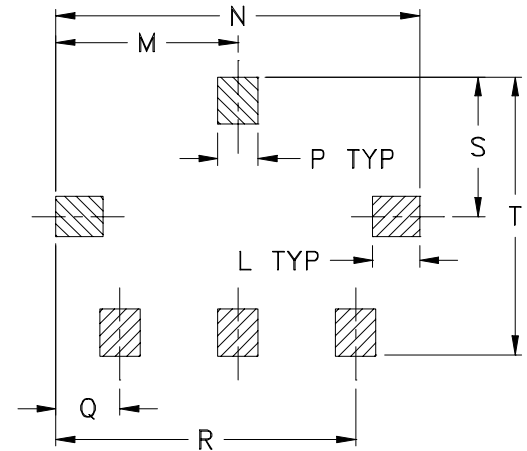

Suggested Layout,
Tolerance to be within ± 0.002

CASE #	A	B	C	D	E	F	G	H	J	K	L	M	N
TTT881	.38 (9.65)	.50 (12.70)	.23 (5.84)	.020 (0.51)	.075 (1.91)	.250 (6.35)	.425 (10.80)	.187 (4.75)	.050 (1.27)	.050 (1.27)	.070 (1.78)	.270 (6.86)	.540 (13.72)

CASE #	P	Q	R	S	T	WT. GRAM
TTT881	.060 (1.52)	.095 (2.41)	.445 (11.30)	.208 (5.28)	.415 (10.54)	.8

Dimensions are in inches (mm). Tolerances: 2 Pl. $\pm .01$; 3 Pl. $\pm .005$

Note:

- Case material: Nickel-Silver alloy.
- Base material: Printed wiring laminate.
- Termination finish:
 - For RoHS Case Styles: 3-5 μ inch (.08-.13 microns) Gold over 120-240 μ inch (3.05-6.10 microns) Nickel plate. All models, (+) suffix.
 - For RoHS-5 Case Styles: Tin-Lead plate. All models, no (+) suffix.

Tape & Reel Packaging TR-F12

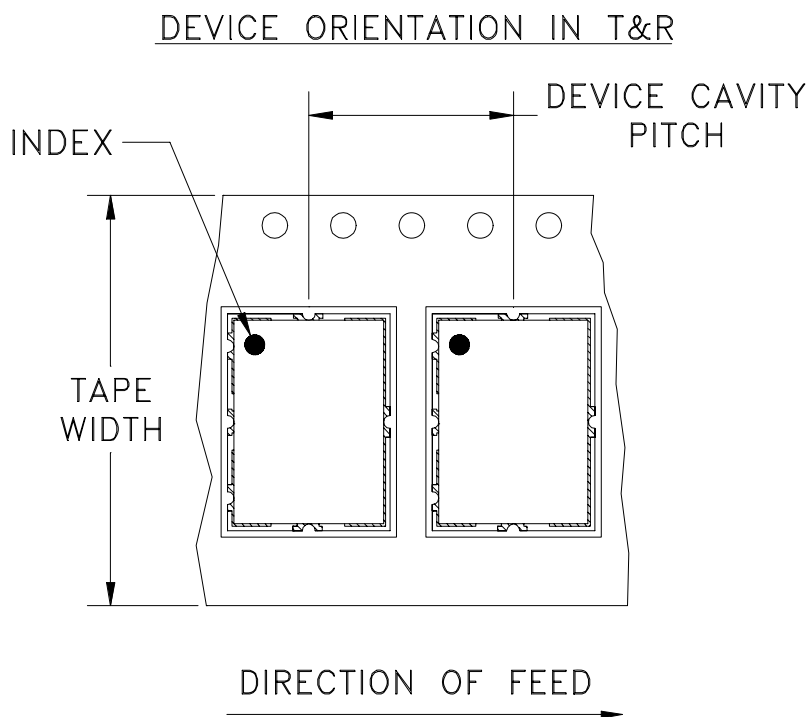

Tape Width, mm	Device Cavity Pitch, mm	Reel Size, inches	Devices per Reel	
24	12	7	Small quantity standards (see note)	10
				20
				50
				100
				200
		13	Standard	500

Note: Please Consult individual model data sheet to determine device per reel availability.

Mini-Circuits carrier tape materials provide protection from ESD (Electro-Static Discharge) during handling and transportation. Tapes are static dissipative and comply with industry standards EIA-481/EIA-541.

Go to: www.minicircuits.com/pages/pdfs/tape.pdf



Distribution Centers NORTH AMERICA 800-654-7949 • 417-335-5935 • Fax 417-335-5945 • EUROPE 44-1252-832600 • Fax 44-1252-837010

Mini-Circuits ISO 9001 & ISO 14001 Certified

INTERNET <http://www.minicircuits.com>

P.O. Box 350166, Brooklyn, New York 11235-0003 (718) 934-4500 Fax (718) 332-4661

THIRD ANGLE PROJECTION

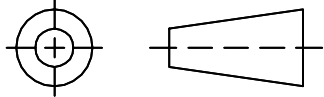

REVISIONS

REV	ECN No.	DESCRIPTION	DATE	DR	AUTH
A	M86762	ADDED CONNECTIONS "lp & lq"	05/23/03	MMG	WL
B	M94598	ADDED CONNECTION "hk"	10/08/04	MMG	HY
C	M102713	UPDATED NOTES & DESCRIPTION	01/14/06	GF	IL
D	M132989	UPDATED NOTE 2	08/24/11	GF	DJ

SUGGESTED MOUNTING CONFIGURATION FOR
TTT166/167 CASE STYLE, "hk"/"lp"/"lq"
"x"/"ck"/"ec" PIN CONNECTIONS

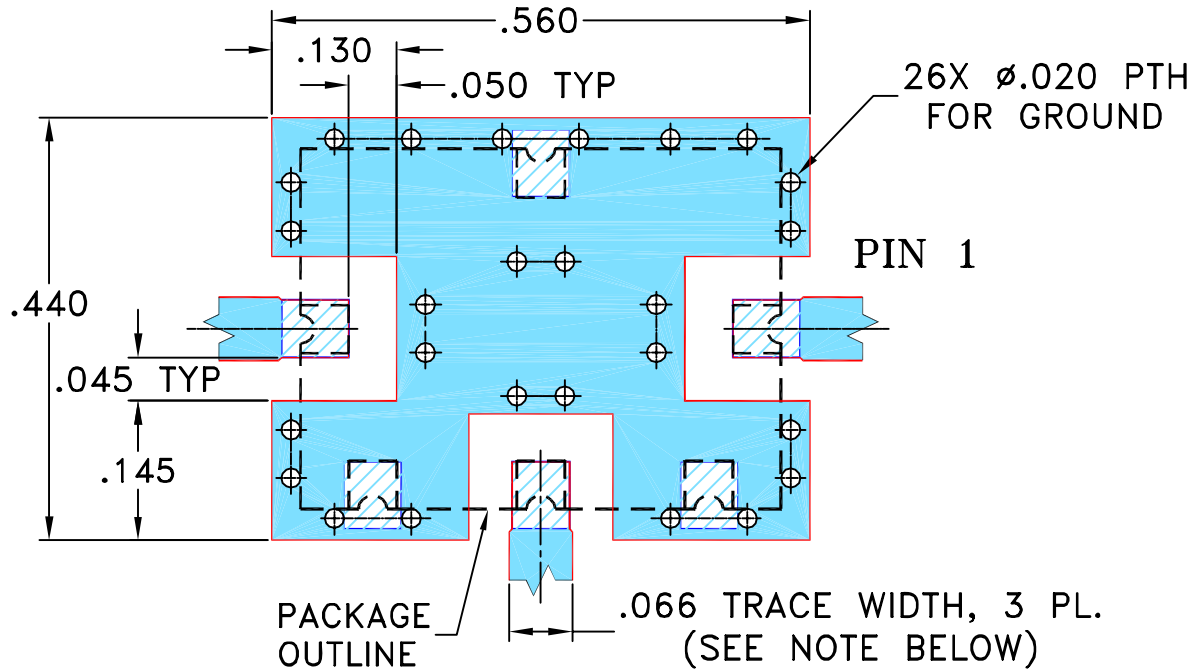

NOTE:

1. TRACE WIDTH IS SHOWN FOR ROGERS R04350B WITH DIELECTRIC THICKNESS .030" ± .002"; COPPER: 1/2 OZ. EACH SIDE. FOR OTHER MATERIALS TRACE WIDTH MAY NEED TO BE MODIFIED.
2. THE USE OF SOLDER MASK OVER THE GROUND AREA UNDER THE UNIT AS SHOWN IS RECOMMENDED TO PREVENT POTENTIAL SHORTING. IF USER CHOOSES TO EXPOSE METAL UNDER THE ENTIRE UNIT GROUND PAD FOR IMPROVED GROUNDING, IT IS RECOMMENDED A SOLDER MASK DAM BE APPLIED AROUND EACH GROUND PAD TO ENSURE FILLET AND CONNECTION AT GROUND PADS.
3. BOTTOM SIDE OF THE PCB IS CONTINUOUS GROUND PLANE.



DENOTES PCB COPPER LAYOUT WITH SMOBC (SOLDER MASK OVER BARE COPPER), SEE NOTE 2.

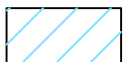

DENOTES COPPER LAND PATTERN FREE OF SOLDER MASK

UNLESS OTHERWISE SPECIFIED

DIMENSIONS ARE IN INCHES
TOLERANCES ON:
2 PL DECIMALS ±
3 PL DECIMALS ± .005
ANGLES ±
FRACTIONS ±

	INITIALS	DATE
DRAWN	GF	03/18/03
CHECKED	IL	04/15/03
APPROVED	DJ	04/15/03



Mini-Circuits®

13 Neptune Avenue
Brooklyn NY 11235

PL, hk/lp/lq/x/ck/ec, TTT166/167,
SYM/HJK/SYAS/SYPD, TB-12

Mini-Circuits®
THIS DOCUMENT AND ITS CONTENTS ARE THE PROPERTY OF MINI-CIRCUITS. EXCEPT FOR USE EXPRESSLY GRANTED, IN WRITING, TO ITS VENDORS, VENDEE AND THE UNITED STATES GOVERNMENT, MINI-CIRCUITS RESERVES ALL PROPRIETARY DESIGN, USE, MANUFACTURING AND REPRODUCTION RIGHTS THERETO. THESE CONTENTS SHALL NOT BE USED, DUPLICATED OR DISCLOSED TO ANY OUTSIDE PARTY, IN WHOLE OR IN PART, WITHOUT WRITTEN PERMISSION OF MINI-CIRCUITS.

SIZE	CODE IDENT	DRAWING NO:	REV:
A	15542	98-PL-079	D
FILE:	98PL079	SCALE: 5:1	SHEET: 1 OF 1

Evaluation Board and Circuit

For Pin Connections Refer to Data Sheet of the DUT

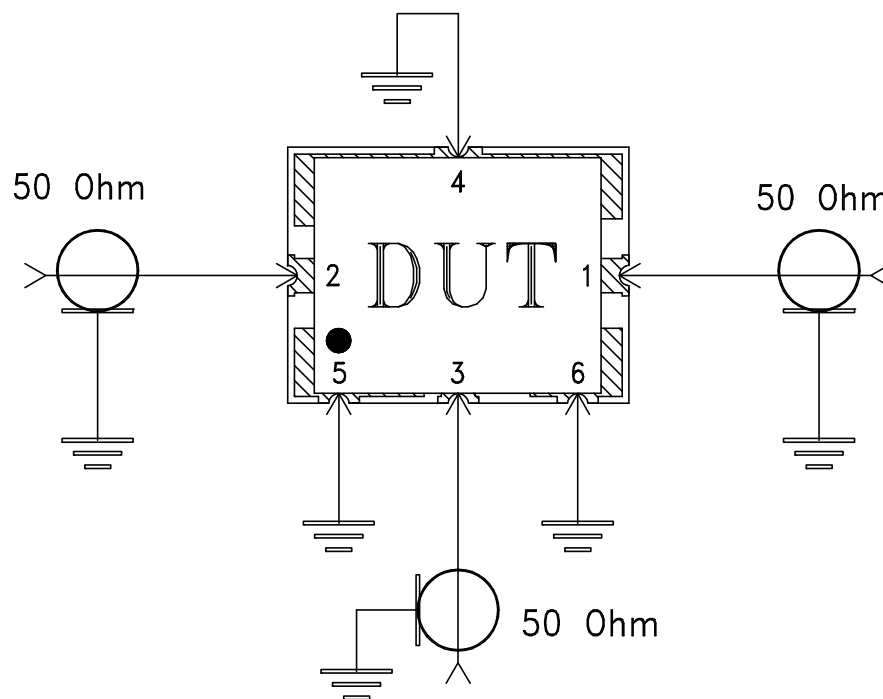
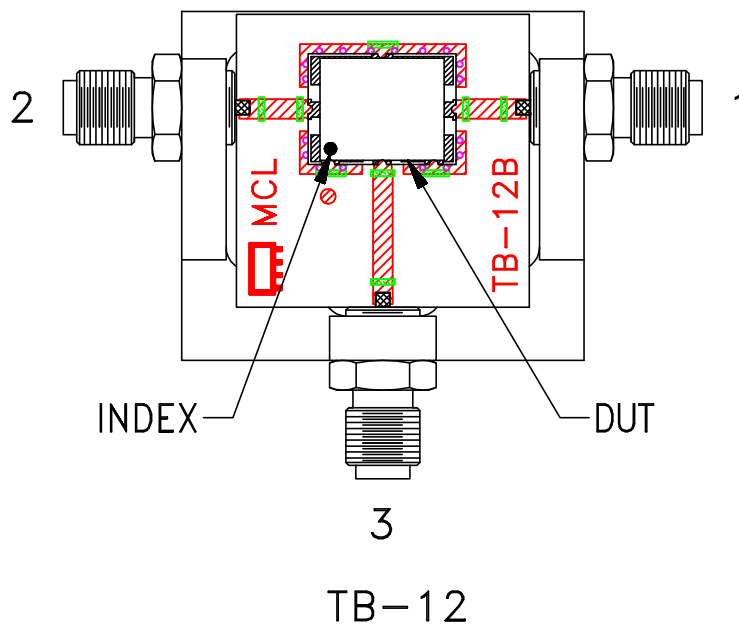

Schematic Diagram

Notes:

1. SMA Female connectors.
2. PCB Material: Rogers R04350 or equivalent, Dielectric Constant=3.5, Thickness=.030 inch.

 **Mini-Circuits®**

All Mini-Circuits products are manufactured under exacting quality assurance and control standards, and are capable of meeting published specifications after being subjected to any or all of the following physical and environmental test.

Specification	Test/Inspection Condition	Reference/Spec
Operating Temperature	-40° to 85°C Ambient Environment	Individual Model Data Sheet
Storage Temperature	-55° to 100° C Ambient Environment	Individual Model Data Sheet
Humidity	90 to 95% RH, 240 hours, 50°C	MIL-STD-202, Method 103, Condition A, Except 50°C and end-point electrical test done within 12 hours
Thermal Shock	-55° to 100°C, 100 cycles	MIL-STD-202, Method 107, Condition A-3, except +100°C
Solder Reflow Heat	Sn-Pb Eutetic Process: 225°C peak Pb-Free Process 245° - 250°C peak	J-STD-020, Table 4-1, 4-2 and 5-2, Figure 5-1
Solderability	10X Magnification	J-STD-002, 95% Coverage
Vibration (High Frequency)	20g peak, 10-2000 Hz, 12 times in each of three perpendicular directions (total 36)	MIL-STD-202, Method 204, Condition D
Mechanical Shock	50g, 11 ms, 1/2-sine, 18 shocks: 3 each direction, each of 3 axes	MIL-STD-202, Method 213, Condition A
Marking Resistance to Solvents	Isopropyl alcohol + mineral spirits at 25°C; terpene defluxer at 25°C; distilled water + proylene glycol monomethyl ether + monoethanolamine at 63°C to 70°C	MIL-STD-202, Method 215