

Surface Mount

Monolithic Amplifier

DC-8 GHz

Product Features

- DC-8 GHz
- Output power, 10.4 dBm typ.
- Internally Matched to 50 Ohms
- Excellent package for heat dissipation, exposed metal bottom
- Flat output power to 10 GHz
- Aqueous washable
- Protected by US Patent 6,943,629
- Low Additive Phase Noise

Typical Applications

- Cellular
- PCS
- Communication receivers & transmitters
- Satellite communication, military

General Description

LEE-39+ (RoHS compliant) is a wideband amplifier offering high dynamic range. It has repeatable performance from lot to lot. It is enclosed in a 3X3mm MCLP molded plastic package. Expected MTBF is 6,000 years at 85°C case temperature.

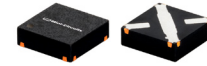

Generic photo used for illustration purposes only

LEE-39+

CASE STYLE: FG873

+RoHS Compliant

The +Suffix identifies RoHS Compliance. See our web site for RoHS Compliance methodologies and qualifications

simplified schematic and pin description

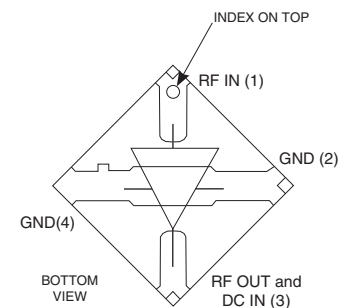
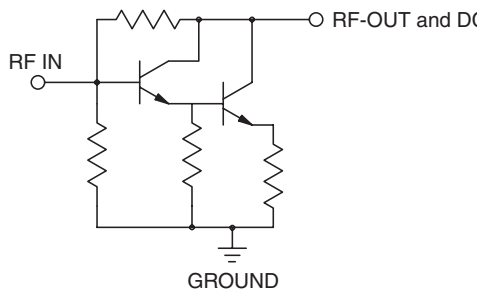

Function	Pin Number	Description
RF IN	1	RF input pin. This pin requires the use of an external DC blocking capacitor chosen for the frequency of operation.
RF-OUT and DC-IN	3	RF output and bias pin. DC voltage is present on this pin; therefore a DC blocking capacitor is necessary for proper operation. An RF choke is needed to feed DC bias without loss of RF signal due to the bias connection, as shown in "Recommended Application Circuit".
GND	2,4	Connections to ground. Use via holes as shown in "Suggested Layout for PCB Design" to reduce ground path inductance for best performance.

Notes

- Performance and quality attributes and conditions not expressly stated in this specification document are intended to be excluded and do not form a part of this specification document.
- Electrical specifications and performance data contained in this specification document are based on Mini-Circuit's applicable established test performance criteria and measurement instructions.
- The parts covered by this specification document are subject to Mini-Circuits standard limited warranty and terms and conditions (collectively, "Standard Terms"); Purchasers of this part are entitled to the rights and benefits contained therein. For a full statement of the Standard Terms and the exclusive rights and remedies thereunder, please visit Mini-Circuits' website at www.minicircuits.com/MCLStore/terms.jsp



Electrical Specifications at 25°C and 35mA, unless noted

Parameter		Min.	Typ.	Max.	Units
Frequency Range*		DC		8	GHz
Gain	f=0.1 GHz	—	21.9	—	dB
	f=1 GHz	—	21.4	—	
	f=2 GHz	18.5	20.8	—	
	f=4 GHz	—	18.3	—	
	f=5 GHz	—	16.6	—	
	f=8 GHz	—	13.5	—	
	f=10 GHz	—	10.5	—	
Input Return Loss	f= DC to 3 GHz		17.5		dB
	f= 3 to 8 GHz		15.5		
Output Return Loss	f= DC to 3 GHz		17.5		dB
	f= 3 to 8 GHz		12.5		
Output Power @ 1 dB compression	f= 2 GHz	10.4	11.6	—	dBm
	f= 8 GHz		10.1		
Output IP3	f= 2 GHz		23.4		dBm
Noise Figure	f= 2 GHz		2.4		dB
Recommended Device Operating Current			35		mA
Device Operating Voltage		3.1	3.5	3.9	V
Device Voltage Variation vs. Temperature at 35 mA			-2.5		mV/°C
Device Voltage Variation vs. Current at 25°C			2.9		mV/mA
Thermal Resistance, junction-to-case ¹			127		°C/W

*Guaranteed specification DC-8 GHz. Low frequency cut off determined by external coupling capacitors.

Absolute Maximum Ratings

Parameter	Ratings
Operating Temperature*	-45°C to 85°C
Storage Temperature	-65°C to 150°C
Operating Current	55mA
Input Power	13dBm

Note: Permanent damage may occur if any of these limits are exceeded.

These ratings are not intended for continuous normal operation.

¹Case is defined as ground leads.

*Based on typical case temperature rise 5°C above ambient.

Notes

A. Performance and quality attributes and conditions not expressly stated in this specification document are intended to be excluded and do not form a part of this specification document.

B. Electrical specifications and performance data contained in this specification document are based on Mini-Circuit's applicable established test performance criteria and measurement instructions.

C. The parts covered by this specification document are subject to Mini-Circuits standard limited warranty and terms and conditions (collectively, "Standard Terms"); Purchasers of this part are entitled to the rights and benefits contained therein. For a full statement of the Standard Terms and the exclusive rights and remedies thereunder, please visit Mini-Circuits' website at www.minicircuits.com/MCLStore/terms.jsp



Product Marking



Markings in addition to model number designation may appear for internal quality control purposes.

Additional Detailed Technical Information

Additional information is available on our web site. To access this information enter the model number on our web site home page.

Performance data, graphs, s-parameter data set (.zip file)

Case Style: FG873

Plastic package, exposed paddle, lead finish: tin-silver over nickel

Tape & Reel: F68

7" Reels with 20, 50, 100, 200, 500, 1K devices

13" Reels with 2K, 3K, 4K devices

Suggested Layout for PCB Design: PL-252

Evaluation Board: TB-413-39+

Environmental Ratings: ENV08T2

Recommended Application Circuit

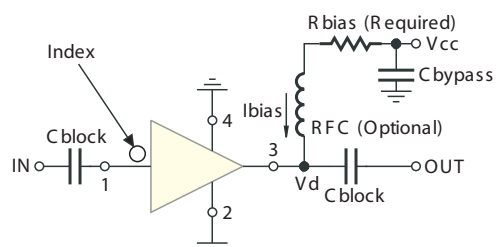

Test Board includes case, connectors, and components (in bold) soldered to PCB

R BIAS	
Vcc	"1%" Res. Values (ohms) for Optimum Biasing
7	107
8	133
9	162
10	191
11	221
12	249
13	280
14	309
15	340
16	365
17	392
18	422
19	453
20	475

Notes

- A. Performance and quality attributes and conditions not expressly stated in this specification document are intended to be excluded and do not form a part of this specification document.
- B. Electrical specifications and performance data contained in this specification document are based on Mini-Circuit's applicable established test performance criteria and measurement instructions.
- C. The parts covered by this specification document are subject to Mini-Circuits standard limited warranty and terms and conditions (collectively, "Standard Terms"); Purchasers of this part are entitled to the rights and benefits contained therein. For a full statement of the Standard Terms and the exclusive rights and remedies thereunder, please visit Mini-Circuits' website at www.minicircuits.com/MCLStore/terms.jsp



ESD Rating

Human Body Model (HBM): Class 1A (250v to < 500v) in accordance with ANSI/ESD STM 5.1 - 2001

Machine Model (MM): Class M1 (< 100v) in accordance with ANSI/ESD STM 5.2 - 1999

MSL Rating

Moisture Sensitivity: MSL1 in accordance with IPC/JEDECJ-STD-020C

No.	Test Required	Condition	Standard	Quantity
1	Visual Inspection	Low Power Microscope Magnification 40x	MIP-IN-0003 (MCT spec)	45 units
2	Electrical Test	Room Temperature	SCD (MCL spec)	45 units
3	SAM Analysis	Less than 10% growth in term of delamination	J-Std-020C (Jedec Standard)	45 units
4	Moisture Sensitivity Level 1	Bake at 125°C for 24 hours Soak at 85°C/85%RH for 168 hours Reflow 3 cycles at 260°C peak	J-Std-020C (Jedec Standard)	45 units

MSL Test Flow Chart

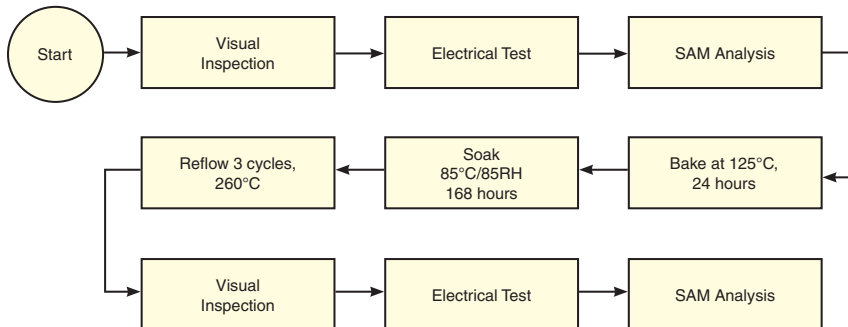

Notes

- A. Performance and quality attributes and conditions not expressly stated in this specification document are intended to be excluded and do not form a part of this specification document.
- B. Electrical specifications and performance data contained in this specification document are based on Mini-Circuit's applicable established test performance criteria and measurement instructions.
- C. The parts covered by this specification document are subject to Mini-Circuits standard limited warranty and terms and conditions (collectively, "Standard Terms"); Purchasers of this part are entitled to the rights and benefits contained therein. For a full statement of the Standard Terms and the exclusive rights and remedies thereunder, please visit Mini-Circuits' website at www.minicircuits.com/MCLStore/terms.jsp



Typical Performance Data

**NOTE: Use PDF Bookmarks to view DATA at required conditions
or to view GRAPHS.**

Definitions:

Input Return Loss = -S11 (dB)

Gain(Power Gain) = S21 (dB)

Reverse Isolation = -S12 (dB)

Output Return Loss = -S22 (dB)

TEST CONDITIONS: Icc = 35mA, Vd = 3.61V @Temperature = +25degC

FREQ	Gain	Isolation	Input Return Loss	Output Return Loss	Stability		FREQ	IP3 Output	1dB Comp. Output	Noise Figure
(MHz)	(dB)	(dB)	(dB)	(dB)	K	Delta	(MHz)	(dBm)	(dBm)	(dB)
50	23.52	25.53	27.58	25.99	1.03	0.80	50	25.58	12.32	2.26
100	23.46	25.90	30.96	24.44	1.04	0.76	100	25.47	11.61	2.12
200	23.42	25.71	29.78	24.12	1.03	0.77	200	25.49	11.61	2.38
400	23.21	25.59	29.41	22.98	1.04	0.76	400	25.38	11.60	2.42
600	22.88	25.37	29.77	21.35	1.04	0.75	600	25.08	11.51	2.38
800	22.55	25.23	28.96	20.32	1.04	0.74	800	25.27	11.13	2.27
1000	22.20	25.00	28.91	19.78	1.05	0.73	1000	25.03	10.95	2.28
1200	21.88	24.79	28.95	19.48	1.05	0.72	1200	25.10	10.89	2.36
1400	21.48	24.52	31.40	18.95	1.06	0.71	1400	25.06	11.10	2.32
1600	21.11	24.29	33.95	18.73	1.06	0.70	1600	25.54	10.95	2.25
1800	20.71	24.00	38.16	18.64	1.06	0.69	1800	26.03	11.39	2.36
2000	20.34	23.71	41.70	18.98	1.07	0.68	2000	25.86	11.10	2.28
2200	19.92	23.44	36.81	19.16	1.07	0.67	2200	25.80	10.60	2.39
2400	19.56	23.15	33.74	19.95	1.08	0.66	2400	25.78	10.75	2.41
2600	19.14	22.85	28.84	20.30	1.08	0.65	2600	25.89	11.40	2.43
2800	18.75	22.59	27.06	21.24	1.09	0.64	2800	26.12	11.62	2.37
3000	18.39	22.25	24.26	21.82	1.09	0.64	3000	26.34	11.41	2.43
3200	18.01	22.01	23.05	22.62	1.09	0.63	3200	26.27	11.62	2.48
3500	17.52	21.62	21.43	24.43	1.10	0.62	3400	26.29	11.69	2.46
4000	16.61	20.89	21.29	26.58	1.11	0.61	3600	26.06	11.80	2.43
4500	15.81	20.30	21.56	25.48	1.13	0.59	3800	25.94	11.98	2.54
5000	15.06	19.74	23.58	22.76	1.14	0.58	4000	26.00	12.19	2.60
5500	14.35	19.24	24.22	19.27	1.15	0.57	4200	25.75	12.19	2.61
6000	13.71	18.78	21.61	17.06	1.16	0.57	4400	25.89	12.10	2.73
6500	13.17	18.38	18.15	15.37	1.17	0.57	4800	25.31	11.97	2.78
7000	12.66	17.97	15.29	14.06	1.16	0.58	5000	25.26	11.57	2.69
7500	12.16	17.66	13.29	13.15	1.17	0.58	5200	25.14	11.27	2.70
8000	11.53	17.26	11.16	11.66	1.16	0.59	5600	25.09	11.20	2.77
9000	9.96	16.85	7.83	9.25	1.18	0.59	5800	24.62	11.13	2.99
10000	7.84	16.59	5.99	7.53	1.23	0.57	6000	24.48	10.87	3.00
11000	5.87	16.11	5.12	6.70	1.27	0.55	6200	24.21	11.45	2.90
12000	4.09	15.73	4.59	6.37	1.32	0.52	6600	23.55	10.93	3.09
13000	2.46	15.85	3.73	5.37	1.29	0.51	6800	23.32	10.83	3.01
14000	0.85	16.87	3.09	4.62	1.32	0.50	7000	23.44	10.73	3.07
15000	0.08	16.99	3.09	4.56	1.30	0.46	7200	22.95	10.59	3.05
16000	0.44	16.06	4.17	5.99	1.42	0.32	8000	22.02	9.31	3.36
17000	1.41	14.05	6.60	8.80	1.45	0.17				
18000	2.17	12.38	8.81	12.89	1.43	0.25				
19000	1.83	12.96	5.58	11.99	1.41	0.35				
20000	-0.65	20.01	3.66	7.37	2.76	0.35				

Typical Performance Data

Definitions:

Input Return Loss = -S11 (dB)

Gain(Power Gain) = S21 (dB)

Reverse Isolation = -S12 (dB)

Output Return Loss = -S22 (dB)

TEST CONDITIONS: Icc = 28mA, Vd = 3.58V @Temperature = +25degC

FREQ	Gain	Isolation	Input Return Loss	Output Return Loss	Stability		FREQ	IP3 Output	1dB Comp. Output	Noise Figure
					K	Delta				
(MHz)	(dB)	(dB)	(dB)	(dB)	K	Delta	(MHz)	(dBm)	(dBm)	(dB)
50	22.81	25.01	29.29	35.32	1.03	0.78	50	22.27	8.95	2.24
100	22.85	24.99	28.47	40.29	1.03	0.78	100	22.16	8.23	2.11
200	22.76	25.09	28.96	36.14	1.04	0.76	200	22.15	8.87	2.41
400	22.53	24.95	29.94	31.18	1.04	0.76	400	22.03	8.82	2.41
600	22.31	24.80	32.49	28.18	1.04	0.75	600	21.80	8.45	2.38
800	21.96	24.61	33.07	26.44	1.04	0.74	800	21.95	8.25	2.28
1000	21.71	24.51	32.04	24.36	1.05	0.72	1000	21.69	8.28	2.30
1200	21.34	24.26	30.78	23.63	1.05	0.71	1200	21.76	8.17	2.33
1400	21.04	24.05	31.70	22.95	1.05	0.71	1400	21.79	7.99	2.30
1600	20.62	23.75	30.21	22.18	1.06	0.70	1600	22.22	8.24	2.26
1800	20.32	23.57	28.84	21.48	1.06	0.68	1800	22.78	8.63	2.31
2000	19.93	23.31	26.46	21.33	1.07	0.67	2000	22.54	8.35	2.29
2200	19.58	23.07	25.21	21.57	1.07	0.67	2200	22.54	7.40	2.37
2400	19.18	22.77	23.05	22.01	1.07	0.66	2400	22.74	7.59	2.35
2600	18.82	22.52	22.67	22.40	1.08	0.65	2600	23.14	8.62	2.39
2800	18.44	22.24	20.76	23.09	1.08	0.64	2800	23.62	9.01	2.33
3000	18.12	22.02	20.39	23.60	1.09	0.63	3000	23.94	8.81	2.43
3200	17.76	21.77	19.46	24.45	1.09	0.62	3200	23.85	8.86	2.47
3500	17.24	21.34	18.46	26.12	1.09	0.62	3400	24.16	9.02	2.44
4000	16.41	20.77	18.31	29.03	1.11	0.60	3600	24.20	9.18	2.40
4500	15.60	20.11	18.67	28.58	1.12	0.59	3800	24.37	9.32	2.47
5000	14.89	19.66	19.95	25.00	1.14	0.58	4000	24.60	9.83	2.57
5500	14.17	19.14	20.85	20.52	1.16	0.57	4200	24.32	9.94	2.52
6000	13.53	18.73	19.69	18.06	1.17	0.56	4400	24.46	10.05	2.69
6500	13.00	18.34	16.89	16.14	1.17	0.56	4800	24.29	10.26	2.74
7000	12.47	17.98	14.55	14.75	1.18	0.56	5000	24.44	9.83	2.63
7500	11.99	17.69	12.73	13.79	1.18	0.56	5200	24.40	9.45	2.66
8000	11.32	17.35	10.68	12.15	1.18	0.57	5600	24.28	10.08	2.67
9000	9.77	16.92	7.60	9.71	1.19	0.57	5800	23.92	10.28	2.90
10000	7.66	16.76	5.88	8.01	1.26	0.55	6000	23.99	9.88	2.90
11000	5.69	16.27	5.05	7.16	1.31	0.53	6200	23.65	10.37	2.83
12000	3.95	15.87	4.52	6.77	1.35	0.50	6600	23.04	10.11	2.96
13000	2.28	15.98	3.71	5.75	1.32	0.49	6800	23.15	10.07	2.93
14000	0.71	16.90	3.09	4.92	1.35	0.48	7000	23.39	10.07	2.96
15000	-0.16	17.07	3.10	4.86	1.34	0.43	7200	22.79	9.94	2.96
16000	0.10	16.20	4.08	6.14	1.45	0.30	8000	21.89	8.74	3.17
17000	0.99	14.33	6.35	8.62	1.51	0.13				
18000	1.85	12.59	8.49	12.38	1.46	0.22				
19000	1.51	13.12	5.40	12.41	1.44	0.32				
20000	-0.93	19.95	3.65	7.76	2.84	0.34				

Typical Performance Data

Definitions:

Input Return Loss = -S11 (dB)

Gain(Power Gain) = S21 (dB)

Reverse Isolation = -S12 (dB)

Output Return Loss = -S22 (dB)

TEST CONDITIONS: Icc = 42mA, Vd = 3.62V @Temperature = +25degC

FREQ	Gain	Isolation	Input Return Loss	Output Return Loss	Stability		FREQ	IP3 Output	1dB Comp. Output	Noise Figure
					K	Delta				
(MHz)	(dB)	(dB)	(dB)	(dB)	K	Delta	(MHz)	(dBm)	(dBm)	(dB)
50	23.90	26.00	22.28	20.23	1.03	0.79	50	28.29	14.18	2.30
100	23.91	26.12	22.92	20.05	1.03	0.78	100	28.19	13.72	2.15
200	23.81	26.17	22.79	19.63	1.03	0.77	200	28.20	13.68	2.40
400	23.56	26.03	23.10	18.85	1.04	0.76	400	27.94	13.67	2.45
600	23.26	25.83	22.86	18.18	1.04	0.75	600	27.52	13.70	2.42
800	22.89	25.58	22.77	17.77	1.04	0.74	800	27.60	13.32	2.33
1000	22.55	25.38	22.83	17.49	1.05	0.73	1000	27.32	13.06	2.30
1200	22.15	25.10	23.58	17.20	1.05	0.72	1200	27.29	12.95	2.38
1400	21.78	24.86	24.68	16.94	1.05	0.71	1400	27.13	13.16	2.34
1600	21.35	24.58	25.73	17.02	1.06	0.70	1600	27.56	13.03	2.28
1800	20.96	24.30	27.20	17.11	1.06	0.69	1800	27.67	13.40	2.37
2000	20.57	23.99	29.40	17.40	1.07	0.68	2000	27.58	13.32	2.32
2200	20.15	23.71	33.67	17.82	1.07	0.67	2200	27.40	12.88	2.42
2400	19.75	23.30	47.29	18.31	1.07	0.67	2400	27.12	12.84	2.43
2600	19.34	23.06	44.21	18.97	1.08	0.65	2600	26.85	13.18	2.44
2800	18.93	22.75	33.45	19.72	1.09	0.64	2800	26.73	13.17	2.41
3000	18.58	22.45	29.64	20.49	1.09	0.64	3000	26.80	13.22	2.48
3200	18.20	22.16	26.58	21.09	1.09	0.63	3200	26.65	13.35	2.52
3500	17.67	21.76	23.99	22.73	1.10	0.62	3400	26.61	13.33	2.49
4000	16.77	21.03	23.53	24.64	1.11	0.61	3600	26.23	13.19	2.48
4500	15.94	20.42	24.02	23.75	1.13	0.59	3800	25.98	13.26	2.59
5000	15.19	19.83	26.64	21.51	1.14	0.59	4000	25.89	13.39	2.66
5500	14.46	19.29	27.34	18.54	1.15	0.58	4200	25.72	13.19	2.64
6000	13.82	18.79	22.86	16.51	1.15	0.57	4400	25.85	13.12	2.74
6500	13.28	18.38	18.78	14.89	1.16	0.58	4800	25.17	12.65	2.82
7000	12.79	17.96	15.85	13.68	1.15	0.58	5000	24.96	12.30	2.77
7500	12.31	17.63	13.76	12.75	1.15	0.59	5200	24.87	12.23	2.80
8000	11.66	17.20	11.48	11.32	1.15	0.60	5600	24.87	11.68	2.83
9000	10.10	16.70	8.05	8.92	1.16	0.61	5800	24.35	11.49	3.06
10000	8.00	16.50	6.09	7.18	1.21	0.59	6000	24.11	11.37	3.05
11000	6.01	16.01	5.20	6.38	1.25	0.57	6200	23.84	11.93	3.05
12000	4.21	15.62	4.62	6.04	1.29	0.54	6600	23.48	11.35	3.15
13000	2.52	15.78	3.76	5.05	1.26	0.53	6800	23.16	11.21	3.10
14000	0.98	16.83	3.10	4.38	1.30	0.52	7000	23.32	11.11	3.17
15000	0.22	16.95	3.10	4.32	1.27	0.48	7200	22.81	10.91	3.14
16000	0.69	15.94	4.19	5.76	1.37	0.35	8000	22.04	9.68	3.43
17000	1.68	13.88	6.78	8.88	1.42	0.19				
18000	2.45	12.18	9.08	13.15	1.39	0.28				
19000	2.04	12.88	5.71	11.51	1.39	0.37				
20000	-0.42	20.08	3.69	6.97	2.69	0.37				

Typical Performance Data

Definitions:

Input Return Loss = -S11 (dB)

Gain(Power Gain) = S21 (dB)

Reverse Isolation = -S12 (dB)

Output Return Loss = -S22 (dB)

TEST CONDITIONS: Icc = 35mA, Vd = 3.78V @Temperature = -45degC

FREQ	Gain	Isolation	Input Return Loss	Output Return Loss	Stability		FREQ	IP3 Output	1dB Comp. Output	Noise Figure
					K	Delta				
(MHz)	(dB)	(dB)	(dB)	(dB)	K	Delta	(MHz)	(dBm)	(dBm)	(dB)
50	23.82	26.38	24.06	22.34	1.04	0.75	50	25.84	12.27	1.83
100	23.81	25.97	27.03	21.87	1.03	0.78	100	25.70	11.80	1.71
200	23.71	26.02	28.19	22.78	1.03	0.77	200	25.72	11.67	1.95
400	23.53	25.80	24.23	20.18	1.03	0.78	400	25.69	11.77	1.97
600	23.23	25.65	24.32	19.21	1.04	0.76	600	25.53	11.58	1.94
800	22.91	25.38	23.88	18.42	1.04	0.76	800	25.77	11.40	1.84
1000	22.56	25.25	24.82	18.10	1.04	0.74	1000	25.54	11.25	1.81
1200	22.21	24.97	24.21	17.80	1.04	0.74	1200	25.62	11.13	1.86
1400	21.86	24.74	25.01	17.60	1.05	0.72	1400	25.66	11.24	1.80
1600	21.46	24.41	26.55	17.64	1.05	0.72	1600	26.18	11.10	1.75
1800	21.08	24.16	29.07	17.74	1.06	0.71	1800	26.69	11.59	1.85
2000	20.69	23.88	31.68	18.11	1.06	0.70	2000	26.54	11.33	1.79
2200	20.28	23.58	34.98	18.19	1.06	0.69	2200	26.50	10.94	1.88
2400	19.97	23.24	43.90	18.91	1.06	0.69	2400	26.51	10.85	1.86
2600	19.48	23.02	44.61	19.60	1.08	0.66	2600	26.72	11.53	1.88
2800	19.18	22.65	35.06	20.46	1.07	0.67	2800	26.97	11.80	1.85
3000	18.80	22.34	29.19	21.21	1.08	0.66	3000	27.35	11.52	1.92
3200	18.46	22.07	26.24	22.45	1.08	0.66	3200	27.24	11.83	1.95
3500	17.92	21.63	24.56	23.47	1.08	0.65	3400	27.36	11.84	1.91
4000	17.00	21.00	24.26	24.10	1.10	0.63	3600	27.23	11.97	1.88
4500	16.21	20.29	23.72	24.32	1.10	0.62	3800	27.13	11.99	1.96
5000	15.57	19.72	25.42	23.24	1.11	0.62	4000	27.23	12.39	1.99
5500	14.82	19.14	29.26	20.26	1.12	0.61	4200	27.04	12.44	2.01
6000	14.18	18.75	24.87	17.56	1.13	0.60	4400	27.19	12.41	2.09
6500	13.72	18.28	18.71	15.55	1.13	0.61	4800	26.63	12.54	2.16
7000	13.18	17.89	14.72	13.28	1.12	0.62	5000	26.50	12.25	2.04
7500	12.71	17.58	12.92	12.33	1.12	0.62	5200	26.56	12.05	2.12
8000	12.18	17.09	11.29	11.09	1.11	0.64	5600	26.57	12.06	2.18
9000	10.80	16.48	8.67	9.68	1.12	0.64	5800	25.94	12.07	2.44
10000	8.66	16.40	5.89	7.19	1.16	0.63	6000	25.75	11.99	2.44
11000	6.48	16.15	4.71	5.89	1.19	0.61	6200	25.48	12.32	2.39
12000	4.99	15.29	4.46	6.08	1.19	0.58	6600	24.91	11.85	2.51
13000	3.53	15.27	4.01	5.43	1.17	0.54	6800	24.64	11.74	2.45
14000	1.53	17.02	2.70	3.95	1.17	0.58	7000	24.63	11.68	2.49
15000	0.42	17.21	2.68	3.72	1.11	0.54	7200	24.04	11.45	2.43
16000	1.20	16.21	3.74	5.60	1.23	0.37	8000	23.13	10.29	2.72
17000	2.58	13.70	6.33	9.76	1.26	0.20				
18000	3.36	11.99	9.00	13.05	1.25	0.32				
19000	3.07	12.25	5.79	11.26	1.20	0.42				
20000	0.68	19.11	2.74	6.96	1.86	0.42				

Typical Performance Data

Definitions:

Input Return Loss = -S11 (dB)

Gain(Power Gain) = S21 (dB)

Reverse Isolation = -S12 (dB)

Output Return Loss = -S22 (dB)

TEST CONDITIONS: Icc = 28mA, Vd = 3.76V @Temperature = -45degC

FREQ	Gain	Isolation	Input Return Loss	Output Return Loss	Stability		FREQ	IP3 Output	1dB Comp. Output	Noise Figure
					K	Delta				
(MHz)	(dB)	(dB)	(dB)	(dB)	K	Delta	(MHz)	(dBm)	(dBm)	(dB)
50	23.25	25.30	39.58	33.00	1.03	0.79	50	22.18	9.16	1.80
100	23.19	25.46	36.32	33.49	1.03	0.77	100	22.04	8.74	1.70
200	23.11	25.38	33.73	33.26	1.03	0.77	200	22.03	8.73	1.94
400	22.98	25.19	42.15	26.66	1.03	0.78	400	22.01	9.01	1.98
600	22.68	25.13	40.23	25.25	1.04	0.75	600	21.86	8.57	1.92
800	22.42	24.96	35.77	23.36	1.04	0.75	800	22.07	8.19	1.80
1000	22.08	24.71	39.64	22.09	1.04	0.74	1000	21.79	8.15	1.81
1200	21.80	24.45	36.95	20.93	1.04	0.74	1200	21.88	8.48	1.84
1400	21.46	24.26	38.93	20.96	1.05	0.73	1400	21.98	8.13	1.80
1600	21.08	24.06	36.33	20.70	1.05	0.71	1600	22.45	8.49	1.76
1800	20.70	23.79	35.10	20.68	1.06	0.70	1800	22.99	8.56	1.84
2000	20.33	23.53	34.18	20.45	1.06	0.69	2000	22.76	8.21	1.77
2200	19.98	23.27	30.96	20.63	1.06	0.68	2200	22.77	7.65	1.87
2400	19.65	22.88	28.75	20.92	1.06	0.69	2400	22.99	7.59	1.86
2600	19.20	22.77	27.23	22.05	1.08	0.66	2600	23.45	8.60	1.85
2800	18.92	22.38	25.03	22.37	1.07	0.67	2800	23.87	8.86	1.84
3000	18.55	22.14	23.04	23.42	1.08	0.66	3000	24.33	8.66	1.91
3200	18.21	21.83	21.35	25.09	1.08	0.65	3200	24.22	9.05	1.94
3500	17.70	21.48	20.85	26.04	1.08	0.64	3400	24.53	9.00	1.88
4000	16.80	20.85	20.66	26.94	1.10	0.62	3600	24.65	9.37	1.82
4500	16.04	20.16	20.79	26.89	1.10	0.62	3800	24.92	9.42	1.94
5000	15.40	19.59	21.53	25.33	1.11	0.62	4000	25.21	9.77	1.98
5500	14.66	19.04	24.75	21.42	1.12	0.61	4200	25.03	9.96	1.95
6000	14.06	18.68	23.48	18.46	1.14	0.59	4400	25.23	10.00	2.07
6500	13.59	18.29	17.74	16.16	1.13	0.60	4800	25.18	10.53	2.12
7000	13.03	17.91	14.03	13.83	1.13	0.61	5000	25.38	10.34	2.01
7500	12.54	17.63	12.36	12.87	1.13	0.61	5200	25.47	9.86	2.08
8000	12.02	17.16	10.87	11.51	1.12	0.63	5600	25.28	10.55	2.12
9000	10.64	16.58	8.43	10.11	1.14	0.62	5800	24.90	10.89	2.36
10000	8.46	16.56	5.73	7.57	1.18	0.61	6000	24.85	10.78	2.36
11000	6.28	16.29	4.64	6.28	1.22	0.59	6200	24.95	10.98	2.27
12000	4.84	15.45	4.40	6.43	1.22	0.56	6600	24.35	10.86	2.43
13000	3.41	15.34	3.95	5.79	1.19	0.52	6800	24.20	10.87	2.38
14000	1.40	17.06	2.64	4.25	1.18	0.56	7000	24.16	10.89	2.46
15000	0.24	17.25	2.68	3.99	1.14	0.51	7200	23.88	10.77	2.39
16000	0.89	16.37	3.71	5.76	1.26	0.34	8000	22.87	9.74	2.59
17000	2.20	13.94	6.13	9.55	1.30	0.17				
18000	3.04	12.18	8.60	12.62	1.27	0.28				
19000	2.81	12.39	5.65	11.64	1.22	0.39				
20000	0.40	19.13	2.71	7.48	1.92	0.40				

Typical Performance Data

Definitions:

Input Return Loss = -S11 (dB)

Gain(Power Gain) = S21 (dB)

Reverse Isolation = -S12 (dB)

Output Return Loss = -S22 (dB)

TEST CONDITIONS: Icc = 42mA, Vd = 3.80V @Temperature = -45degC

FREQ	Gain	Isolation	Input Return Loss	Output Return Loss	Stability		FREQ	IP3 Output	1dB Comp. Output	Noise Figure
					K	Delta				
(MHz)	(dB)	(dB)	(dB)	(dB)	K	Delta	(MHz)	(dBm)	(dBm)	(dB)
50	24.16	26.28	20.20	18.55	1.03	0.79	50	28.72	14.47	1.88
100	24.18	26.24	21.71	18.87	1.02	0.80	100	28.59	14.07	1.73
200	24.09	26.25	22.10	19.14	1.03	0.79	200	28.61	14.02	1.97
400	23.84	26.21	20.33	17.21	1.03	0.77	400	28.51	14.09	1.95
600	23.54	25.95	20.64	16.98	1.03	0.77	600	28.22	14.04	1.94
800	23.19	25.77	20.44	16.36	1.04	0.76	800	28.41	13.65	1.86
1000	22.85	25.52	20.79	16.36	1.04	0.75	1000	28.17	13.36	1.82
1200	22.46	25.31	20.67	15.96	1.04	0.73	1200	28.19	13.32	1.87
1400	22.10	25.01	21.70	16.01	1.05	0.73	1400	28.11	13.32	1.83
1600	21.67	24.70	22.67	16.09	1.05	0.72	1600	28.59	13.22	1.80
1800	21.31	24.39	24.12	16.43	1.05	0.71	1800	28.81	13.66	1.89
2000	20.90	24.11	25.27	16.71	1.06	0.70	2000	28.75	13.53	1.83
2200	20.49	23.76	27.34	17.00	1.06	0.69	2200	28.65	13.21	1.90
2400	20.12	23.43	30.58	17.52	1.06	0.69	2400	28.38	13.01	1.89
2600	19.67	23.19	34.32	18.37	1.07	0.67	2600	28.18	13.49	1.92
2800	19.34	22.80	44.03	19.05	1.07	0.67	2800	28.12	13.62	1.89
3000	18.98	22.47	38.16	20.00	1.07	0.67	3000	28.26	13.58	2.02
3200	18.61	22.16	30.70	21.07	1.08	0.66	3200	28.16	13.75	2.00
3500	18.07	21.80	27.88	21.79	1.08	0.65	3400	28.12	13.79	1.95
4000	17.14	21.10	27.28	22.64	1.10	0.63	3600	27.82	13.80	1.91
4500	16.34	20.39	26.68	22.82	1.10	0.62	3800	27.56	13.87	2.02
5000	15.68	19.76	29.06	22.08	1.11	0.62	4000	27.47	13.95	2.03
5500	14.91	19.18	35.97	19.48	1.11	0.61	4200	27.34	13.93	2.02
6000	14.28	18.76	25.15	17.01	1.12	0.60	4400	27.55	13.90	2.14
6500	13.82	18.30	19.28	15.11	1.12	0.62	4800	26.76	13.62	2.19
7000	13.30	17.86	15.13	12.98	1.11	0.63	5000	26.53	13.28	2.09
7500	12.83	17.55	13.34	12.06	1.11	0.63	5200	26.52	13.19	2.15
8000	12.32	17.01	11.62	10.77	1.10	0.66	5600	26.60	12.80	2.24
9000	10.98	16.38	8.90	9.35	1.11	0.66	5800	26.02	12.63	2.48
10000	8.81	16.30	6.01	6.89	1.14	0.65	6000	25.69	12.52	2.48
11000	6.58	16.05	4.78	5.60	1.17	0.63	6200	25.31	13.00	2.43
12000	5.14	15.17	4.52	5.77	1.17	0.60	6600	24.95	12.39	2.56
13000	3.65	15.19	4.03	5.13	1.15	0.56	6800	24.67	12.24	2.55
14000	1.61	16.95	2.71	3.70	1.15	0.60	7000	24.57	12.11	2.54
15000	0.54	17.17	2.68	3.48	1.10	0.56	7200	24.01	11.86	2.56
16000	1.42	16.14	3.79	5.34	1.21	0.39	8000	23.16	10.71	2.80
17000	2.91	13.49	6.56	9.81	1.24	0.24				
18000	3.61	11.83	9.31	13.20	1.23	0.34				
19000	3.29	12.14	5.99	10.76	1.19	0.44				
20000	0.90	19.17	2.80	6.51	1.83	0.44				

Typical Performance Data

Definitions:

Input Return Loss = -S11 (dB)

Gain(Power Gain) = S21 (dB)

Reverse Isolation = -S12 (dB)

Output Return Loss = -S22 (dB)

TEST CONDITIONS: Icc = 35mA, Vd = 3.45V @Temperature = +85degC

FREQ	Gain	Isolation	Input Return Loss	Output Return Loss	Stability		FREQ	IP3 Output	1dB Comp. Output	Noise Figure
					K	Delta				
(MHz)	(dB)	(dB)	(dB)	(dB)	K	Delta	(MHz)	(dBm)	(dBm)	(dB)
50	23.17	25.41	37.24	30.94	1.03	0.77	50	25.47	12.30	2.63
100	23.11	25.48	41.69	28.72	1.04	0.76	100	25.39	11.61	2.49
200	23.06	25.37	34.21	26.01	1.03	0.77	200	25.42	11.82	2.73
400	22.84	25.20	39.95	25.26	1.04	0.76	400	25.21	11.61	2.77
600	22.51	25.11	41.39	24.24	1.04	0.74	600	24.86	11.63	2.78
800	22.20	24.91	41.63	23.01	1.05	0.73	800	25.00	10.88	2.65
1000	21.82	24.70	61.76	22.48	1.05	0.72	1000	24.74	10.91	2.69
1200	21.50	24.46	54.08	21.34	1.05	0.71	1200	24.78	10.91	2.76
1400	21.10	24.28	56.66	20.43	1.06	0.69	1400	24.71	10.92	2.76
1600	20.72	24.02	41.91	20.04	1.07	0.68	1600	25.18	11.01	2.69
1800	20.32	23.77	35.81	19.69	1.07	0.67	1800	25.62	11.37	2.77
2000	19.93	23.49	32.16	19.66	1.07	0.66	2000	25.44	11.06	2.74
2200	19.49	23.24	29.07	19.97	1.08	0.65	2200	25.37	10.49	2.83
2400	19.13	22.85	26.51	20.15	1.08	0.65	2400	25.29	10.57	2.86
2600	18.66	22.68	24.40	21.20	1.10	0.62	2600	25.27	11.25	2.88
2800	18.32	22.34	22.58	21.71	1.09	0.62	2800	25.41	11.44	2.88
3000	17.93	22.09	20.98	22.63	1.10	0.61	3000	25.57	11.44	2.94
3200	17.55	21.80	20.23	23.54	1.10	0.61	3200	25.39	11.59	2.99
3500	17.03	21.47	19.34	24.92	1.11	0.59	3400	25.43	11.55	2.97
4000	16.10	20.80	19.61	27.25	1.13	0.58	3600	25.13	11.41	2.95
4500	15.29	20.14	19.94	26.21	1.15	0.57	3800	25.04	11.48	3.10
5000	14.55	19.61	20.88	22.86	1.16	0.56	4000	24.93	11.76	3.16
5500	13.74	19.10	20.93	18.61	1.18	0.55	4200	24.71	11.58	3.18
6000	13.09	18.74	19.22	16.61	1.20	0.54	4400	24.83	11.59	3.30
6500	12.52	18.30	16.25	15.48	1.20	0.54	4800	24.22	11.03	3.42
7000	11.98	17.93	14.77	14.56	1.21	0.53	5000	24.17	10.65	3.31
7500	11.51	17.63	13.24	13.83	1.21	0.54	5200	23.98	10.46	3.35
8000	10.81	17.27	11.01	12.21	1.22	0.54	5600	23.99	10.17	3.37
9000	9.02	16.98	7.34	9.17	1.24	0.55	5800	23.44	10.07	3.61
10000	6.87	16.98	5.85	7.65	1.34	0.52	6000	23.29	9.84	3.59
11000	5.12	16.23	5.41	7.34	1.39	0.49	6200	22.92	10.50	3.51
12000	3.29	15.62	4.74	6.68	1.41	0.48	6600	22.33	9.91	3.68
13000	1.36	16.15	3.63	5.46	1.41	0.48	6800	22.35	9.84	3.64
14000	-0.12	17.14	3.29	4.91	1.50	0.45	7000	22.42	9.81	3.72
15000	-0.53	16.71	3.60	5.32	1.51	0.38	7200	21.97	9.64	3.71
16000	-0.46	16.32	4.53	6.55	1.74	0.28	8000	21.34	8.35	4.01
17000	0.12	14.57	6.74	8.39	1.76	0.15				
18000	1.04	12.87	9.00	11.74	1.65	0.19				
19000	0.64	13.32	5.62	12.69	1.64	0.30				
20000	-2.13	21.47	4.14	7.88	4.08	0.30				

Typical Performance Data

Definitions:

Input Return Loss = -S11 (dB)

Gain(Power Gain) = S21 (dB)

Reverse Isolation = -S12 (dB)

Output Return Loss = -S22 (dB)

TEST CONDITIONS: Icc = 28mA, Vd = 3.43V @Temperature = +85degC

FREQ	Gain	Isolation	Input Return Loss	Output Return Loss	Stability		FREQ	IP3 Output	1dB Comp. Output	Noise Figure
(MHz)	(dB)	(dB)	(dB)	(dB)	K	Delta	(MHz)	(dBm)	(dBm)	(dB)
50	22.41	24.68	25.14	27.91	1.03	0.77	50	22.32	9.26	2.62
100	22.37	24.81	24.45	28.79	1.04	0.76	100	22.24	8.88	2.49
200	22.31	24.71	25.80	31.29	1.04	0.76	200	22.26	9.03	2.67
400	22.16	24.59	25.00	28.15	1.04	0.76	400	22.05	9.16	2.75
600	21.92	24.48	24.47	27.58	1.04	0.74	600	21.77	8.49	2.76
800	21.60	24.35	25.43	26.87	1.05	0.73	800	21.89	8.23	2.67
1000	21.23	24.20	24.55	25.88	1.05	0.71	1000	21.59	8.61	2.67
1200	20.92	23.89	25.33	25.08	1.05	0.71	1200	21.65	8.15	2.76
1400	20.64	23.77	25.14	23.72	1.06	0.69	1400	21.65	8.24	2.72
1600	20.25	23.52	24.60	22.95	1.06	0.68	1600	22.08	8.26	2.66
1800	19.88	23.30	23.44	22.04	1.07	0.67	1800	22.65	8.74	2.75
2000	19.48	23.00	22.45	21.62	1.07	0.66	2000	22.39	8.30	2.71
2200	19.10	22.82	21.63	21.79	1.08	0.64	2200	22.41	7.58	2.81
2400	18.75	22.46	20.63	21.70	1.07	0.64	2400	22.62	7.39	2.81
2600	18.32	22.38	19.59	22.74	1.09	0.62	2600	22.97	8.65	2.85
2800	17.98	22.00	18.70	22.97	1.09	0.62	2800	23.37	9.08	2.81
3000	17.63	21.79	17.68	23.47	1.09	0.61	3000	23.68	8.95	2.89
3200	17.29	21.52	17.17	24.44	1.09	0.61	3200	23.53	9.09	2.97
3500	16.75	21.15	16.76	25.44	1.10	0.60	3400	23.81	9.09	2.95
4000	15.85	20.62	17.17	28.50	1.13	0.57	3600	23.77	9.32	2.92
4500	15.05	19.92	17.53	29.73	1.14	0.57	3800	23.92	9.45	3.05
5000	14.35	19.43	18.25	25.45	1.16	0.56	4000	24.07	9.88	3.09
5500	13.55	18.97	18.66	20.08	1.18	0.54	4200	23.77	9.75	3.13
6000	12.92	18.63	17.65	17.58	1.20	0.53	4400	23.91	10.00	3.27
6500	12.35	18.25	15.25	16.28	1.21	0.53	4800	23.61	9.76	3.34
7000	11.82	17.94	14.02	15.32	1.22	0.52	5000	23.66	9.39	3.27
7500	11.31	17.67	12.62	14.52	1.23	0.52	5200	23.60	9.34	3.29
8000	10.61	17.31	10.61	12.85	1.23	0.53	5600	23.49	9.43	3.30
9000	8.81	17.11	7.17	9.66	1.27	0.53	5800	23.09	9.46	3.52
10000	6.70	17.11	5.75	8.13	1.38	0.50	6000	23.15	9.11	3.47
11000	4.95	16.38	5.35	7.81	1.43	0.47	6200	22.75	9.73	3.45
12000	3.16	15.75	4.70	7.12	1.45	0.46	6600	22.10	9.38	3.58
13000	1.23	16.26	3.62	5.78	1.45	0.46	6800	22.25	9.30	3.51
14000	-0.29	17.22	3.25	5.21	1.53	0.43	7000	22.40	9.31	3.56
15000	-0.76	16.81	3.58	5.57	1.56	0.36	7200	22.02	9.22	3.59
16000	-0.82	16.52	4.47	6.66	1.82	0.26	8000	21.36	7.91	3.89
17000	-0.29	14.80	6.56	8.16	1.82	0.13				
18000	0.75	13.11	8.69	11.28	1.70	0.17				
19000	0.31	13.44	5.51	13.03	1.69	0.27				
20000	-2.40	21.33	4.13	8.23	4.17	0.28				

Typical Performance Data

Definitions:

Input Return Loss = -S11 (dB)

Gain(Power Gain) = S21 (dB)

Reverse Isolation = -S12 (dB)

Output Return Loss = -S22 (dB)

TEST CONDITIONS: Icc = 42mA, Vd = 3.46V @Temperature = +85degC

FREQ	Gain	Isolation	Input Return Loss	Output Return Loss	Stability		FREQ	IP3 Output	1dB Comp. Output	Noise Figure
(MHz)	(dB)	(dB)	(dB)	(dB)	K	Delta	(MHz)	(dBm)	(dBm)	(dB)
50	23.61	25.57	25.25	23.22	1.02	0.80	50	28.15	13.85	2.67
100	23.58	25.80	24.95	21.34	1.03	0.78	100	28.11	13.46	2.50
200	23.45	25.82	24.13	20.49	1.03	0.77	200	28.10	13.34	2.73
400	23.24	25.63	26.35	20.92	1.04	0.76	400	27.74	13.24	2.81
600	22.91	25.49	26.44	20.19	1.04	0.75	600	27.12	13.30	2.79
800	22.59	25.31	26.88	19.58	1.05	0.74	800	27.09	12.91	2.69
1000	22.20	25.13	27.54	19.13	1.05	0.72	1000	26.75	12.81	2.73
1200	21.83	24.87	28.85	18.88	1.06	0.71	1200	26.68	12.73	2.81
1400	21.41	24.58	29.58	18.28	1.06	0.70	1400	26.49	12.85	2.78
1600	21.00	24.30	31.68	18.10	1.06	0.69	1600	26.84	12.60	2.74
1800	20.57	24.08	33.70	17.80	1.07	0.67	1800	26.82	12.98	2.83
2000	20.15	23.75	40.34	18.04	1.08	0.66	2000	26.65	12.84	2.78
2200	19.73	23.45	45.72	18.36	1.08	0.65	2200	26.45	12.58	2.89
2400	19.35	23.15	33.47	18.93	1.09	0.64	2400	26.12	12.33	2.90
2600	18.87	22.92	30.37	19.66	1.10	0.62	2600	25.81	12.61	2.92
2800	18.51	22.58	25.95	20.51	1.10	0.62	2800	25.63	12.62	2.93
3000	18.13	22.27	24.19	21.23	1.10	0.62	3000	25.63	12.67	2.98
3200	17.72	21.99	22.66	22.22	1.11	0.61	3200	25.36	12.75	3.07
3500	17.18	21.56	21.19	23.79	1.12	0.60	3400	25.29	12.48	3.06
4000	16.24	20.94	21.60	25.41	1.14	0.58	3600	24.95	12.27	3.00
4500	15.41	20.26	21.93	24.39	1.15	0.57	3800	24.70	12.43	3.10
5000	14.67	19.70	23.16	21.59	1.16	0.56	4000	24.62	12.55	3.22
5500	13.85	19.19	22.71	17.92	1.18	0.55	4200	24.35	12.32	3.22
6000	13.19	18.78	20.11	16.12	1.20	0.54	4400	24.49	12.16	3.41
6500	12.63	18.32	16.83	15.06	1.20	0.54	4800	23.88	11.52	3.45
7000	12.11	17.92	15.24	14.19	1.20	0.54	5000	23.73	11.10	3.38
7500	11.61	17.61	13.64	13.44	1.20	0.54	5200	23.52	11.01	3.43
8000	10.94	17.21	11.23	11.94	1.20	0.55	5600	23.48	10.51	3.43
9000	9.13	16.88	7.48	8.89	1.23	0.56	5800	22.96	10.35	3.70
10000	7.00	16.88	5.90	7.39	1.32	0.53	6000	22.92	10.16	3.70
11000	5.23	16.15	5.45	7.07	1.36	0.51	6200	22.41	10.82	3.64
12000	3.37	15.43	4.76	6.47	1.38	0.50	6600	22.04	10.23	3.80
13000	1.44	16.14	3.66	5.23	1.40	0.50	6800	21.92	10.11	3.78
14000	-0.04	17.08	3.26	4.70	1.46	0.47	7000	21.98	10.09	3.80
15000	-0.42	16.70	3.59	5.15	1.48	0.40	7200	21.65	9.89	3.82
16000	-0.28	16.24	4.56	6.44	1.70	0.29	8000	21.03	8.58	4.14
17000	0.34	14.36	6.88	8.44	1.71	0.17				
18000	1.23	12.69	9.20	11.99	1.61	0.21				
19000	0.83	13.22	5.75	12.33	1.61	0.31				
20000	-2.01	21.39	4.15	7.58	3.96	0.31				

Typical Performance Curves

GAIN vs. TEMPERATURE

INPUT POWER = -25dBm, CURRENT = 35mA

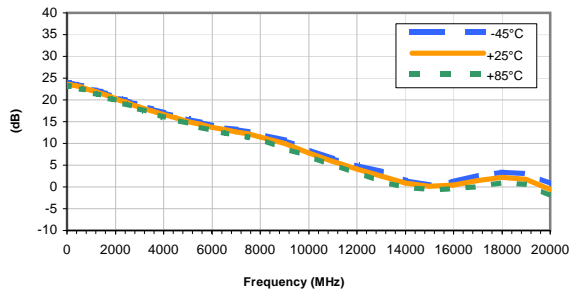

GAIN vs. CURRENT

INPUT POWER = -25dBm, Temperature = +25°C

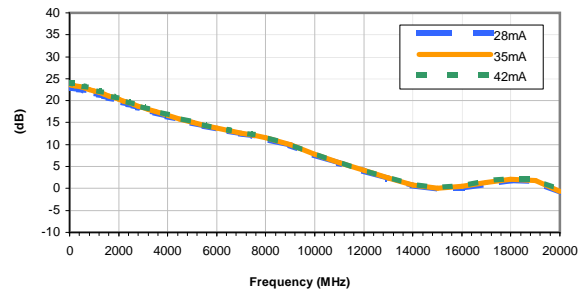

ISOLATION vs. TEMPERATURE

INPUT POWER = -25dBm, CURRENT = 35mA

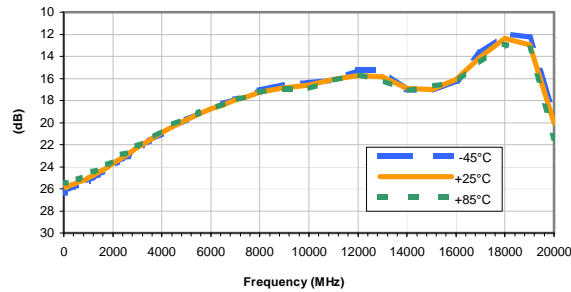

ISOLATION vs. CURRENT

INPUT POWER = -25dBm, Temperature = +25°C

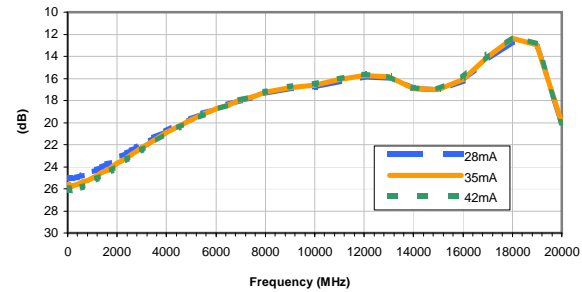

INPUT RETURN LOSS vs. TEMPERATURE

INPUT POWER = -25dBm, CURRENT = 35mA

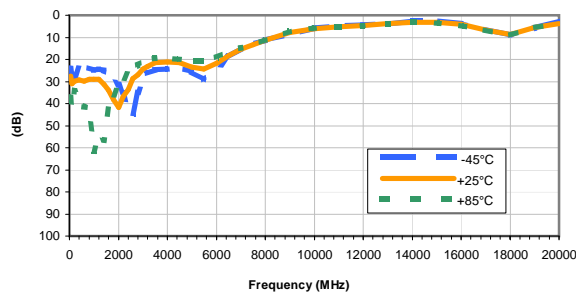

INPUT RETURN LOSS vs. CURRENT

INPUT POWER = -25dBm, Temperature = +25°C

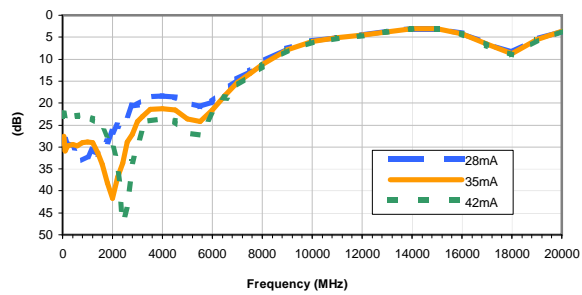

OUTPUT RETURN LOSS vs. TEMPERATURE

INPUT POWER = -25dBm, CURRENT = 35mA

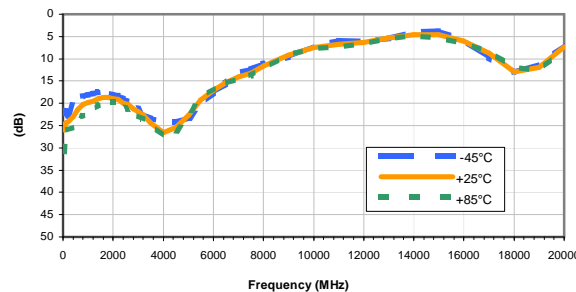

OUTPUT RETURN LOSS vs. CURRENT

INPUT POWER = -25dBm, Temperature = +25°C

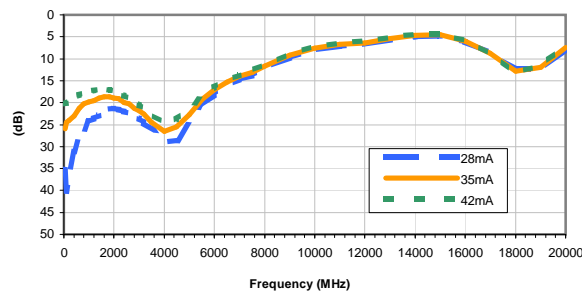

Typical Performance Curves

OUTPUT IP3 vs. TEMPERATURE

INPUT POWER = -25dBm, CURRENT = 35mA

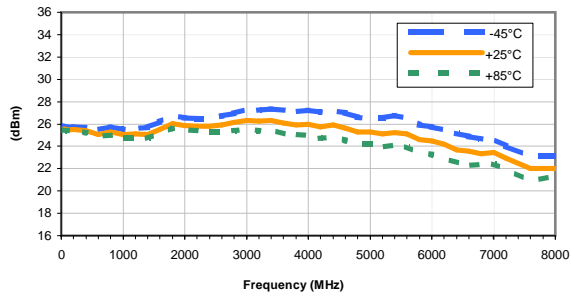

OUTPUT IP-3 vs. CURRENT

INPUT POWER = -25dBm, Temperature = +25°C

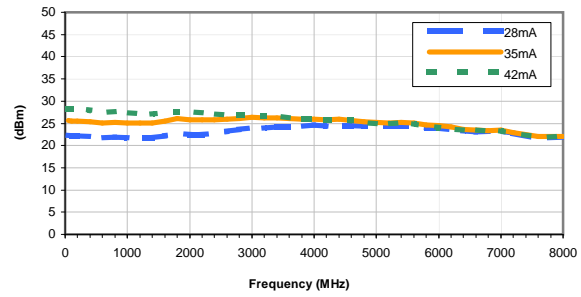

OUTPUT POWER at 1dB Compression vs. TEMPERATURE

CURRENT = 35mA

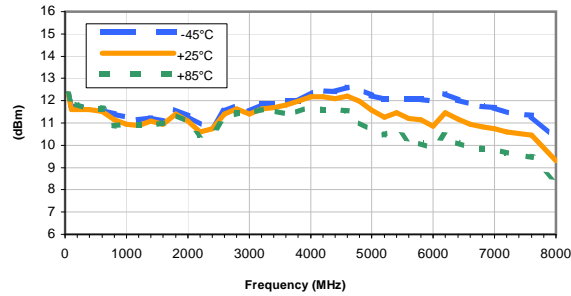

OUTPUT POWER at 1dB Compression vs. CURRENT

Temperature = +25°C

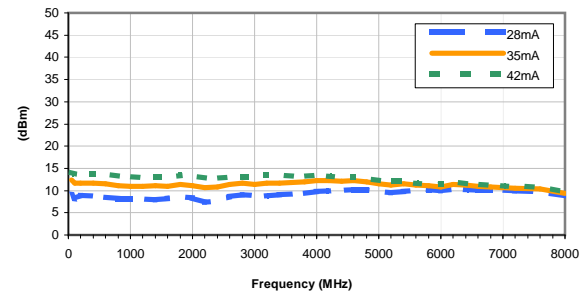

Noise Figure vs. TEMPERATURE

CURRENT = 35mA

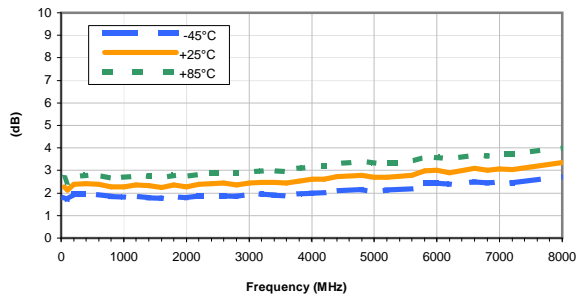

Noise Figure vs. CURRENT

Temperature = +25°C

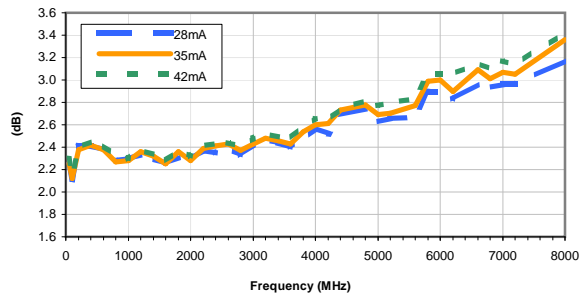

Typical Performance Curves

GAIN vs. TEMPERATURE

INPUT POWER = -25dBm, CURRENT = 35mA

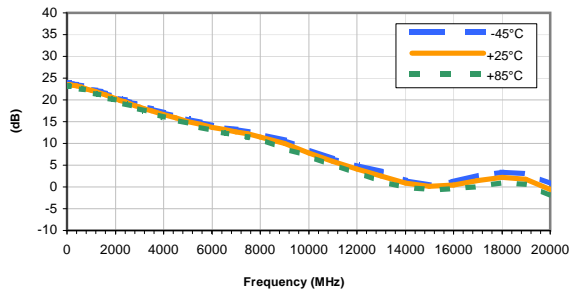

GAIN vs. CURRENT

INPUT POWER = -25dBm, Temperature = +25°C

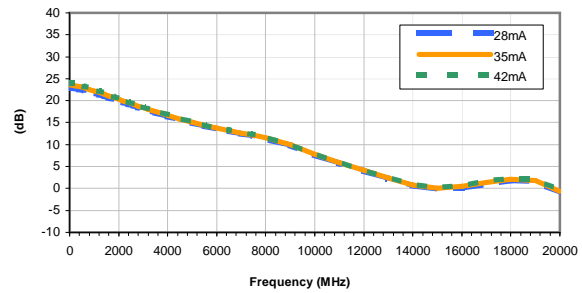

ISOLATION vs. TEMPERATURE

INPUT POWER = -25dBm, CURRENT = 35mA

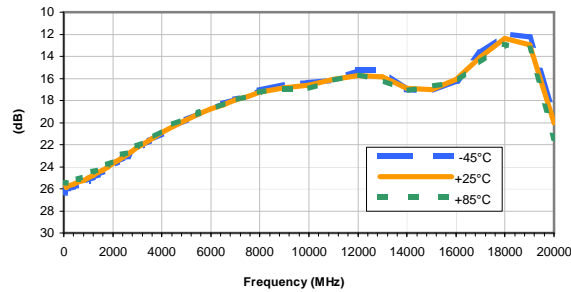

ISOLATION vs. CURRENT

INPUT POWER = -25dBm, Temperature = +25°C

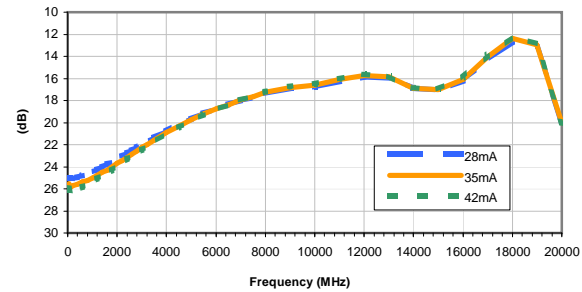

INPUT RETURN LOSS vs. TEMPERATURE

INPUT POWER = -25dBm, CURRENT = 35mA

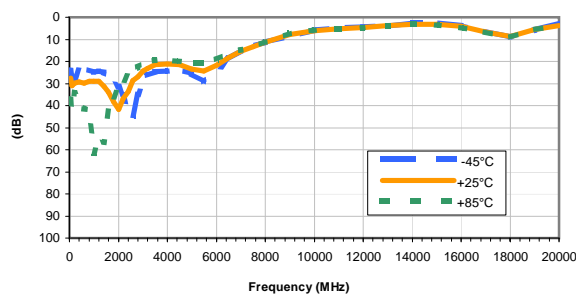

INPUT RETURN LOSS vs. CURRENT

INPUT POWER = -25dBm, Temperature = +25°C

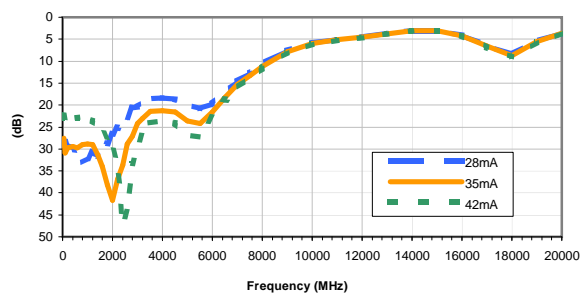

OUTPUT RETURN LOSS vs. TEMPERATURE

INPUT POWER = -25dBm, CURRENT = 35mA

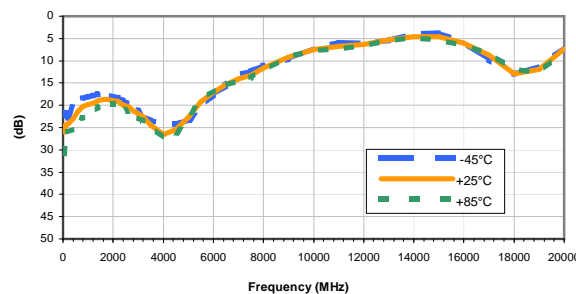

OUTPUT RETURN LOSS vs. CURRENT

INPUT POWER = -25dBm, Temperature = +25°C

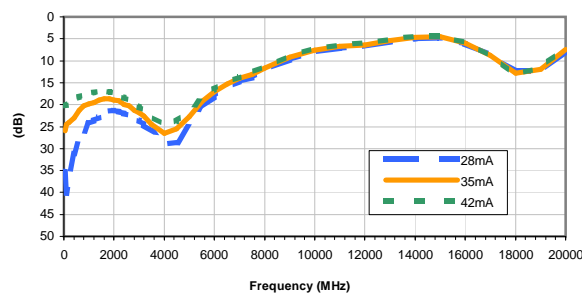

Typical Performance Curves

OUTPUT IP3 vs. TEMPERATURE

INPUT POWER = -25dBm, CURRENT = 35mA

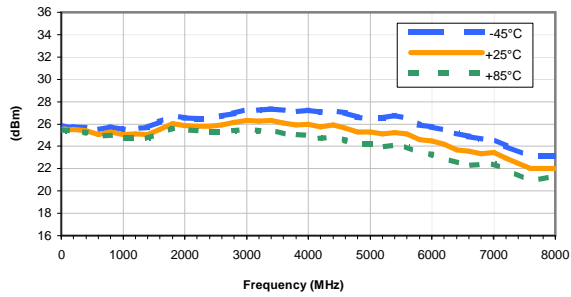

OUTPUT IP-3 vs. CURRENT

INPUT POWER = -25dBm, Temperature = +25°C

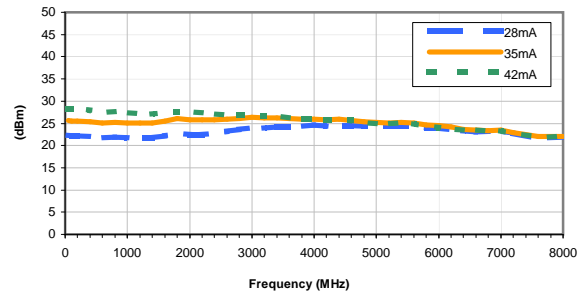

OUTPUT POWER at 1dB Compression vs. TEMPERATURE

CURRENT = 35mA

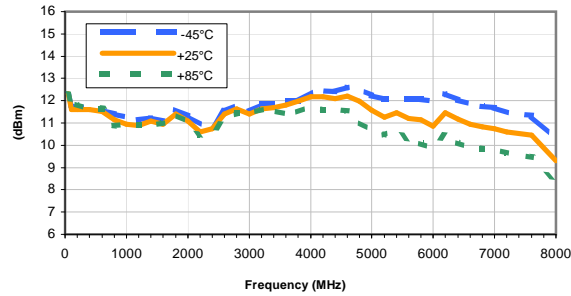

OUTPUT POWER at 1dB Compression vs. CURRENT

Temperature = +25°C

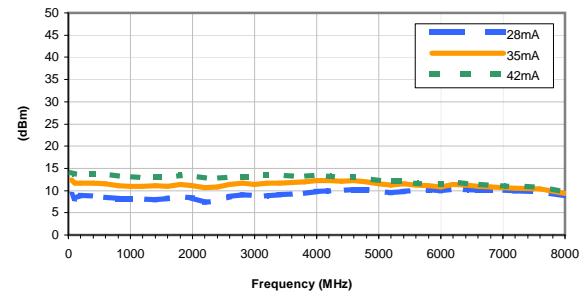

Noise Figure vs. TEMPERATURE

CURRENT = 35mA

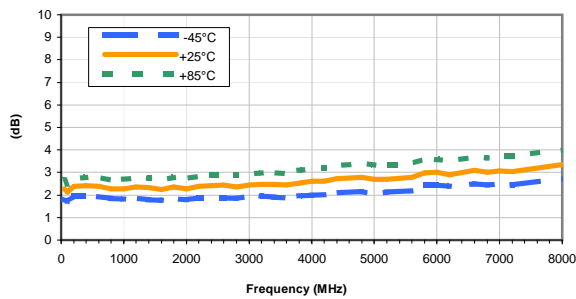

Noise Figure vs. CURRENT

Temperature = +25°C

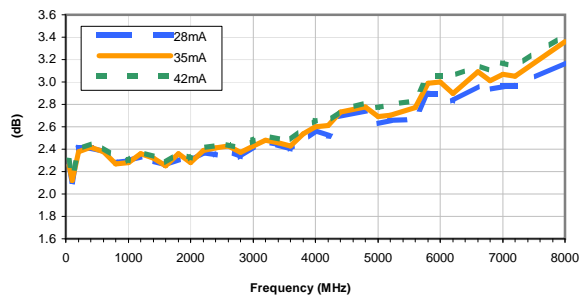

Outline Dimensions

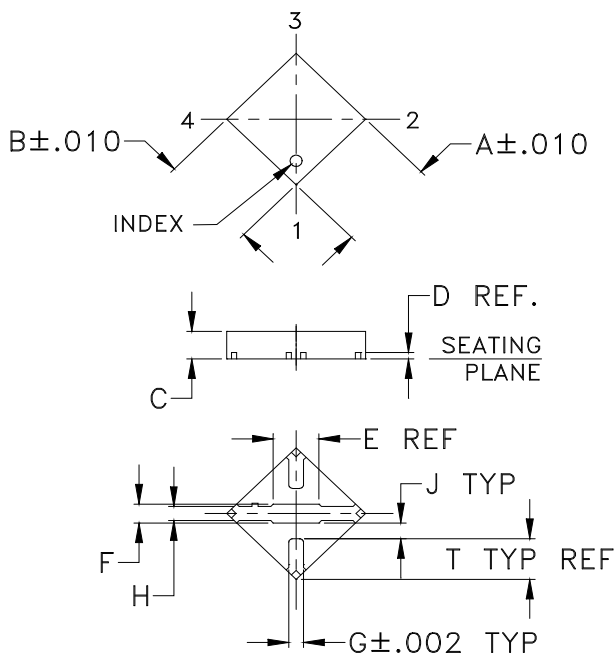

PCB Land Pattern

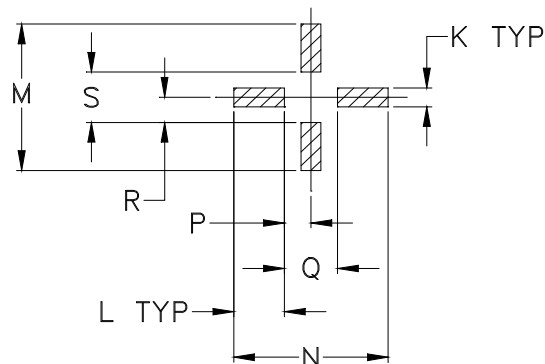

Suggested Layout,
Tolerance to be within $\pm .002$

CASE #	A	B	C	D	E	F	G	H	J	K	L	M	N	P
FG873	.118 (3.00)	.118 (3.00)	.035 (0.89)	.008 (0.20)	.07 (1.78)	.024 (0.60)	.017 (0.43)	.018 (0.46)	.021 (0.52)	.024 (0.61)	.061 (1.55)	.186 (4.72)	.186 (4.72)	.032 (0.81)

CASE #	Q	R	S	T	WT. GRAM
FG873	.064 (1.63)	.032 (0.81)	.064 (1.63)	.050 (1.27)	.02

Dimensions are in inches (mm). Tolerances: 2 Pl. $\pm .01$; 3Pl. $\pm .004$

Notes:

- Case material: Plastic.
- Termination finish:

For RoHS Case Styles: Tin-Silver alloy plate over Nickel barrier or Matte-Tin per Data Sheet.
All models, (+) suffix.

For RoHS-5 Case Styles: Tin-Lead plate. All models, no (+) suffix.



P.O. Box 350166, Brooklyn, New York 11235-0003 (718) 934-4500 Fax (718) 332-4661 For detailed performance specs & shopping online see Mini-Circuits web site



The Design Engineers Search Engine Provides ACTUAL Data Instantly From MINI-CIRCUITS At: www.minicircuits.com

RF/IF MICROWAVE COMPONENTS

Tape & Reel Packaging TR-F68

DEVICE ORIENTATION IN T&R

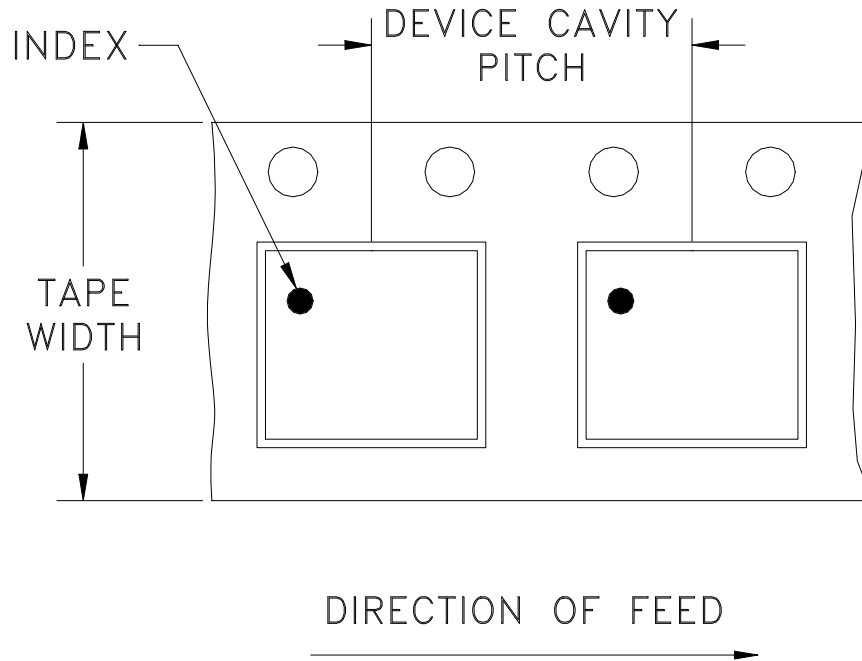

Tape Width, mm	Device Cavity Pitch, mm	Reel Size, inches	Devices per Reel see note	
12	8	7	Small quantity standard	20
				50
				100
				200
				500
		7	Standard	1000
		13	Standard	2000
				3000
4000				

Mini-Circuits carrier tape materials provide protection from ESD (Electro-Static Discharge) during handling and transportation. Tapes are static dissipative and comply with industry standards EIA-481/EIA-541.

Go to: www.minicircuits.com/pages/pdfs/tape.pdf



INTERNET <http://www.minicircuits.com>

P.O. Box 350166, Brooklyn, New York 11235-0003 (718) 934-4500 Fax (718) 332-4661

Distribution Centers NORTH AMERICA 800-654-7949 • 417-335-5935 • Fax 417-335-5945 • EUROPE 44-1252-832600 • Fax 44-1252-837010

Mini-Circuits ISO 9001 & ISO 14001 Certified

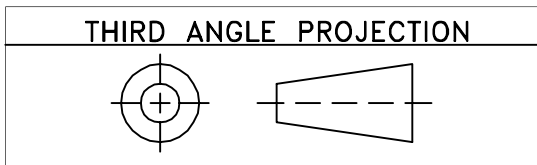

REVISIONS					
REV OR	ECN No.	DESCRIPTION	DATE	DR	AUTH
	M108436	NEW RELEASE	11/14/06	PW	IG

SUGGESTED MOUNTING CONFIGURATION
FOR FG873 CASE STYLE, "cb" PIN CONNECTION

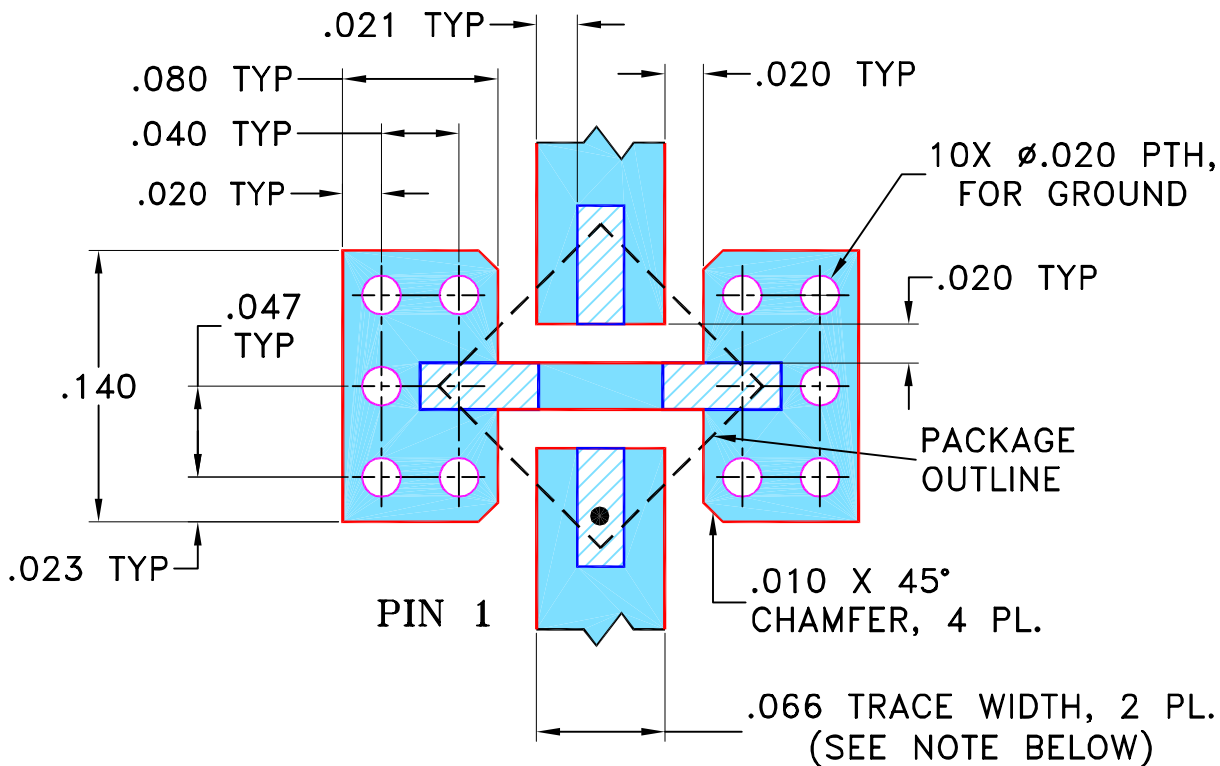

NOTES:

- TRACE WIDTH IS SHOWN FOR ROGERS R04350B WITH DIELECTRIC THICKNESS $.030" \pm .002"$; COPPER: 1/2 OZ. EACH SIDE. FOR OTHER MATERIALS TRACE WIDTH MAY NEED TO BE MODIFIED.
- BOTTOM SIDE OF THE PCB IS CONTINUOUS GROUND PLANE.



DENOTES PCB COPPER LAYOUT WITH SMOBC (SOLDER MASK OVER BARE COPPER)

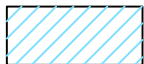

DENOTES COPPER LAND PATTERN FREE OF SOLDER MASK

UNLESS OTHERWISE SPECIFIED	INITIALS		DATE
DIMENSIONS ARE IN INCHES TOLERANCES ON: 2 PL DECIMALS \pm 3 PL DECIMALS \pm .005 ANGLES \pm FRACTIONS \pm	DRAWN	PW	11/11/06
	CHECKED	IL	11/14/06
	APPROVED	IG	11/14/06



Mini-Circuits®

13 Neptune Avenue
Brooklyn NY 11235

PL, cb, FG873, LEE, TB-413-XX+

SIZE A	CODE IDENT 15542	DRAWING NO: 98-PL-252	REV: OR
FILE: 98PL252	SCALE: 10:1	SHEET: 1 OF 1	

Mini-Circuits®
THIS DOCUMENT AND ITS CONTENTS ARE THE PROPERTY OF MINI-CIRCUITS. EXCEPT FOR USE EXPRESSLY GRANTED, IN WRITING, TO ITS VENDORS, VENDEE AND THE UNITED STATES GOVERNMENT, MINI-CIRCUITS RESERVES ALL PROPRIETARY DESIGN, USE, MANUFACTURING AND REPRODUCTION RIGHTS THERETO. THESE CONTENTS SHALL NOT BE USED, DUPLICATED OR DISCLOSED TO ANY OUTSIDE PARTY, IN WHOLE OR IN PART, WITHOUT WRITTEN PERMISSION OF MINI-CIRCUITS.

Evaluation Board and Circuit

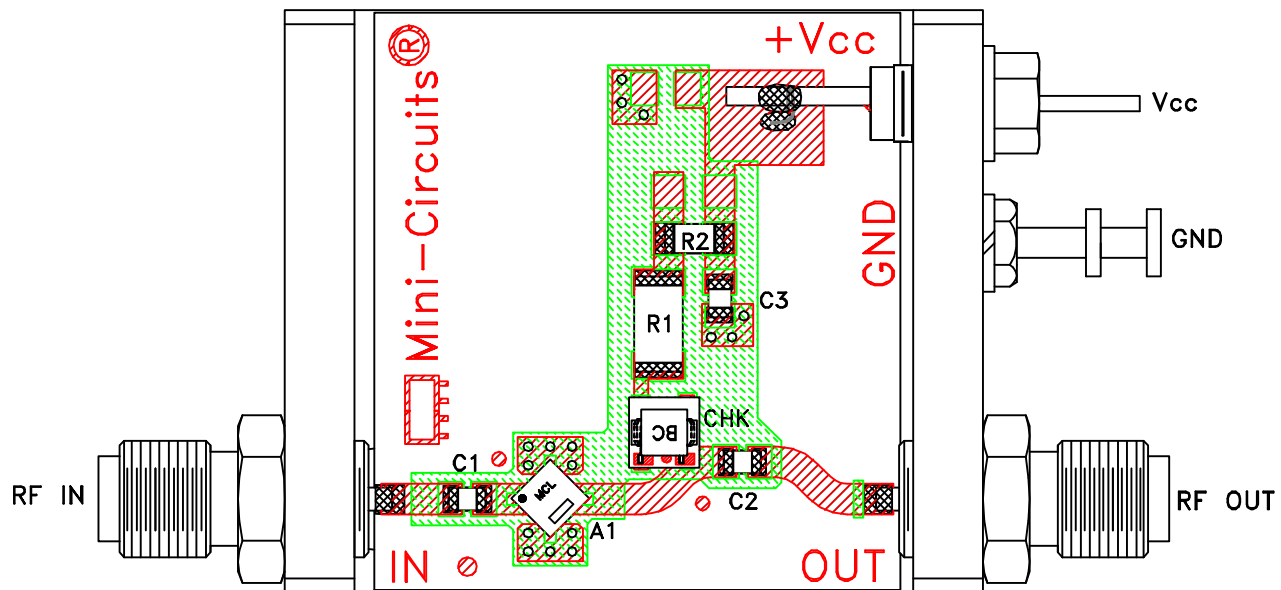

TB-413-39+

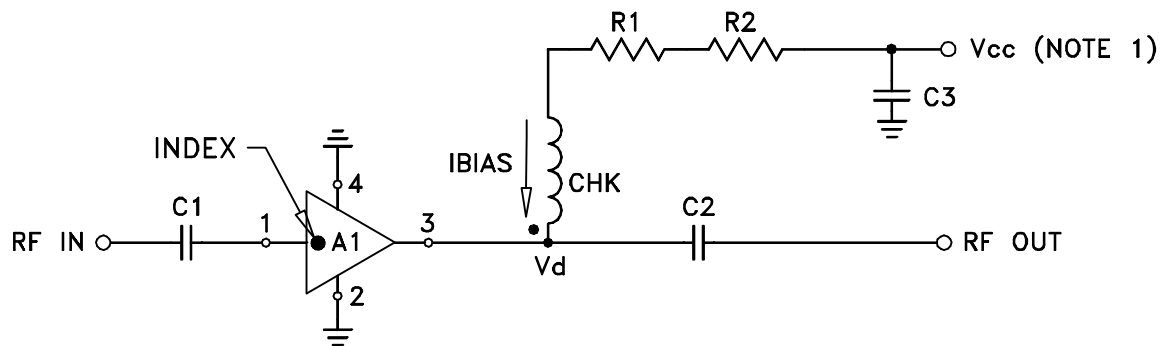

COMPONENT	VALUE
A1	LEE-39(+)
C1 (NOTE 4)	2400 pF
C2 (NOTE 4)	2400 pF
C3 (bypass)	0.1 uF
R1	243 Ohms, 0.75W
R2	0 Ohm, 0.25W
CHK	Mini-Circuits TCCH-80+

Schematic Diagram

NOTES:

1. Vcc voltage: $+12 \pm 0.2V$.
2. SMA Female connectors.
3. PCB material: Rogers R04350 or equivalent, dielectric constant=3.5, dielectric thickness=.030 inch.
4. Capacitors, C1 & C2 should be free of resonance up to the highest frequency specified.

 **Mini-Circuits®**

All Mini-Circuits products are manufactured under exacting quality assurance and control standards, and are capable of meeting published specifications after being subjected to any or all of the following physical and environmental test.

Specification	Test/Inspection Condition	Reference/Spec
Operating Temperature	-45° to 85°C or -40° to 85°C Ambient Environment	Individual Model Data Sheet
Storage Temperature	-65° to 150° C Ambient Environment	Individual Model Data Sheet
Thermal Shock	-55° to 100°C, 100 cycles	MIL-STD-202, Method 107, Condition A-3, except +100°C
Mechanical Shock	1.5Kg, 0.5 ms, 5 shock pulses, Y1 direction only	MIL-STD-883, Method 2002, Condition B, except Y1 direction only
Vibration (Variable Frequency)	50g peak	MIL-STD-883, Method 2007, Condition B
Autoclave	15 psig, 100% RH, 121°C, 96 hours	JESD22-A102, Condition C
HAST	130°C, 85% RH, 96 hours	JESD22-A110
Solderability	10X Magnification	J-STD-002, Para 4.2.5, Test S, 95% Coverage
Solder Reflow Heat	Sn-Pb Eutetic Process: 240°C peak Pb-Free Process: 260°C peak	J-STD-020, Table 4-1, 4-2 and 5-2; Figure 5-1
Moisture Sensitivity: Level 1	Bake at 125°C for 24 hours Soak at 85°C/85% RH for 168 hours, Reflow 3 cycles at 260°C peak	J-STD-020
Marking Resistance to Solvents	Isopropyl alcohol + mineral spirits at 25°C; terpene defluxer at 25°C; distilled water + proylene glycol monomethyl ether +	MIL-STD-202, Method 215



All Mini-Circuits products are manufactured under exacting quality assurance and control standards, and are capable of meeting published specifications after being subjected to any or all of the following physical and environmental test.

Specification	Test/Inspection Condition	Reference/Spec
	monoethanolamine at 63°C to 70°C	