



5 V AGC AMPLIFIER + VIDEO AMPLIFIER

UPC3219GV

FEATURES

- **ON-CHIP LOW DISTORTION AMPLIFIER:**
IIP₃ = -1 dBm at minimum gain
- **WIDE AGC DYNAMIC RANGE:**
GCR = 42 dB TYP
- **ON-CHIP VIDEO AMPLIFIER:**
V_{OUT} = 1.0 V_{P-P} at single-ended output
- **SUPPLY VOLTAGE:**
V_{CC} = 5 V
- **PACKAGED IN 8 PIN SSOP SUITABLE FOR SURFACE MOUNTING**

APPLICATIONS

- Digital CATV
- Cable modem receivers
- IP Telephony receivers

DESCRIPTION

NEC's UPC3219GV is a Silicon Monolithic IC designed for use as an AGC Amplifier for digital CATV, cable modem and IP telephony systems. This IC consists of a two stage gain control amplifier and a fixed gain video amplifier. The device provides a differential input and differential output for noise performance, which eliminates shielding requirements.

The package is 8-pin SSOP (Shrink Small Outline Package) suitable for surface mount.

This IC is manufactured using NEC's 10 GHz ft NESAT™ II AL silicon bipolar process. This process uses silicon nitride passivation film. This material can protect chip surface from external pollution and prevent corrosion/migration. Thus, this IC has excellent performance, uniformity and reliability.

NEC's stringent quality assurance and test procedures ensure the highest reliability and performance.

VOLTAGE GAIN vs. AUTOMATIC GAIN CONTROL VOLTAGE

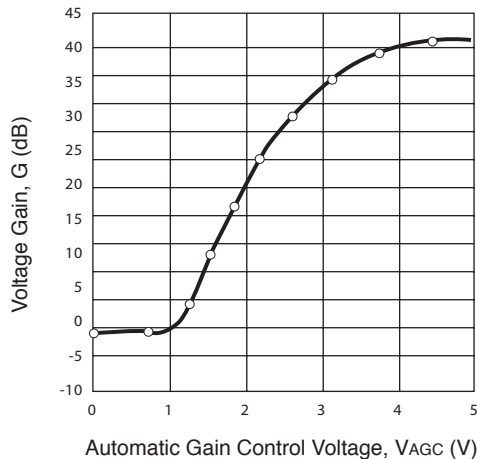

PACKAGE OUTLINE S08

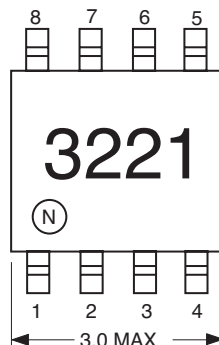

All dimensions are typical unless specified otherwise.

ELECTRICAL CHARACTERISTICS

(T_A = 25°C, V_{CC} = 5 V, Z_S = 1KΩ, Z_L = 1KΩ, f_{IN} = 45 MHz, single-ended output), unless otherwise noted

PART NUMBER PACKAGE OUTLINE			UPC3219GV S08		
SYMBOLS	PARAMETERS AND CONDITIONS	UNITS	MIN	TYP	MAX
DC Characteristics					
I _{CC}	Circuit Current (no input signal)	mA	28	35	42
RF Characteristics					
BW	Frequency Bandwidth, V _{AGC} = 3 V ¹	MHz		100	
G _{MAX}	Maximum Gain, V _{AGC} = 4.5 V	dB	39	42	45
G _{MIN}	Minimum Gain, V _{AGC} = 0.5 V	dB	-4	0	4
GCR	Gain Control Range, V _{AGC} = 0.5 to 4.5 V	dB	35	42	—
N _{FAGC}	Noise Figure, V _{AGC} = 4.5 V at MAX Gain	dB	—	9	10.5
V _{OUT}	Output Voltage, Single Ended Output	V _{P-P}		1.0	
IM ₃	Third Order Intermodulation Distortion, f _{IN1} = 44 MHz, f _{IN2} = 45 MHz, V _{IN} = 30 dBmV per tone ²	dBc		55	

Note:

1. -3dB with respect to 10 MHz gain
2. V_{AGC} is adjusted to establish V_{OUT} = 1.0 V_{P-P} per tone

UPC3219GV

ABSOLUTE MAXIMUM RATINGS¹

(T_A = 25°C, unless otherwise specified)

SYMBOLS	PARAMETERS	UNITS	RATINGS
V _{CC}	Supply Voltage	V	6.0
P _D	Power Dissipation ² , T _A = 85°C	mW	250
T _{OP1}	Operating Ambient Temp.	°C	-40 to +85
T _{STG}	Storage Temperature	°C	-50 to +150

Notes:

- Operation in excess of any one of these parameters may result in permanent damage.
- Mounted on a 50 x 50 x 1.6 mm epoxy glass PWB, with copper

RECOMMENDED OPERATING CONDITIONS

SYMBOL	PARAMETER	UNITS	MIN	TYP	MAX
V _{CC}	Supply Voltage	V	4.5	5.0	5.5
T _A	Operating Ambient Temp. ¹	°C	-40	+25	+85
V _{AGC}	Gain Control Voltage Range	V	0.5	-	4.5
V _{IN}	Video Input Signal Range	dBmV	9		30

Note:

- V_{CC} = 4.5 to 5.5 V

ORDERING INFORMATION

PART NUMBER	QUANTITY
UPC3219GV-E1-A	1 kp/reel

Note:

Embossed tape 8 mm wide. Pin 1 indicates pull-out direction of tape.

TYPICAL PERFORMANCE CURVES (T_A = 25°C, unless otherwise specified)

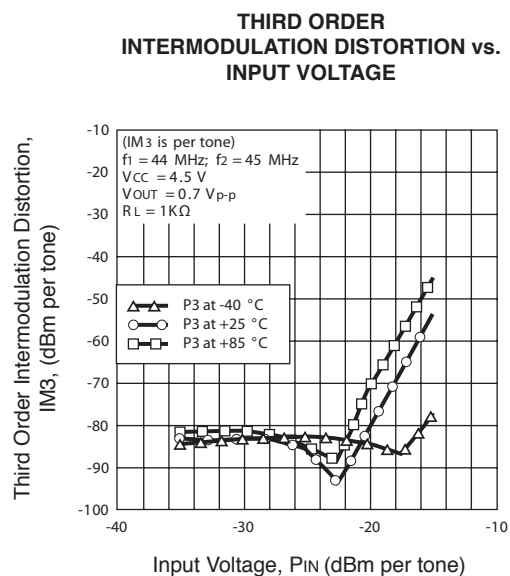
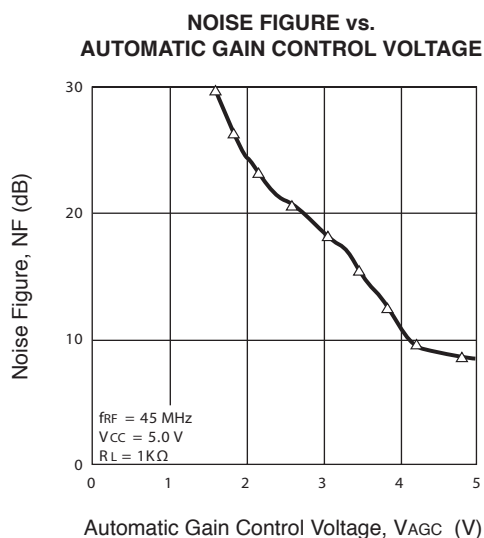

TYPICAL PERFORMANCE CURVES, cont. (TA = 25°C, unless otherwise specified)

SUPPLY CURRENT vs. SUPPLY VOLTAGE

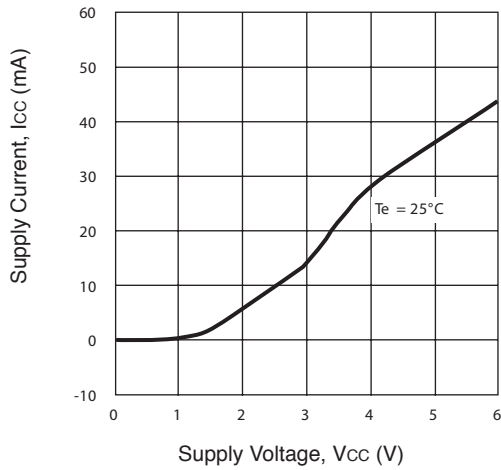

INPUT THIRD ORDER INTERCEPT POINT vs. INPUT POWER

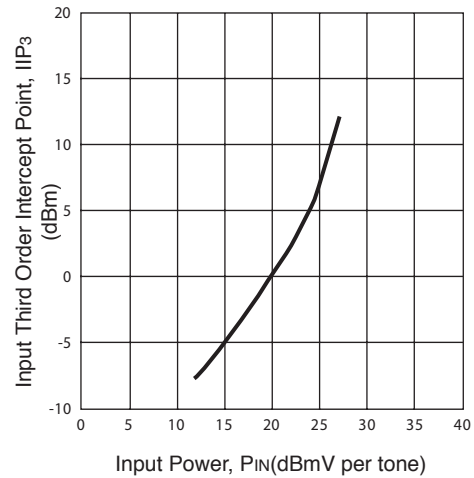

VOLTAGE GAIN vs. FREQUENCY

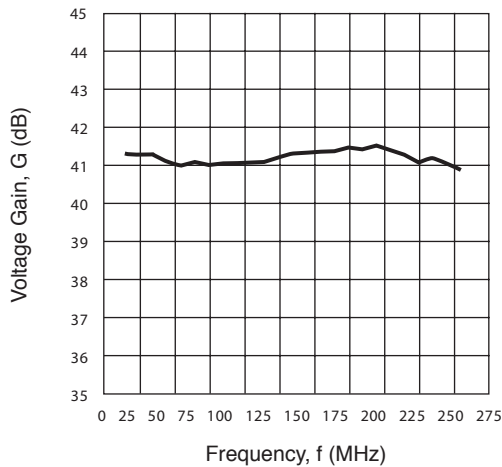

VOLTAGE OUTPUT vs. FREQUENCY

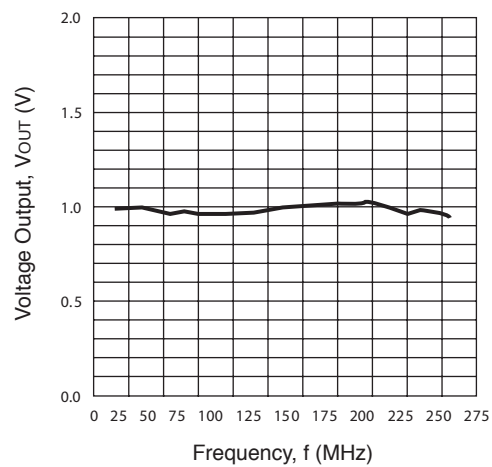

VOLTAGE GAIN vs. AUTOMATIC GAIN CONTROL VOLTAGE

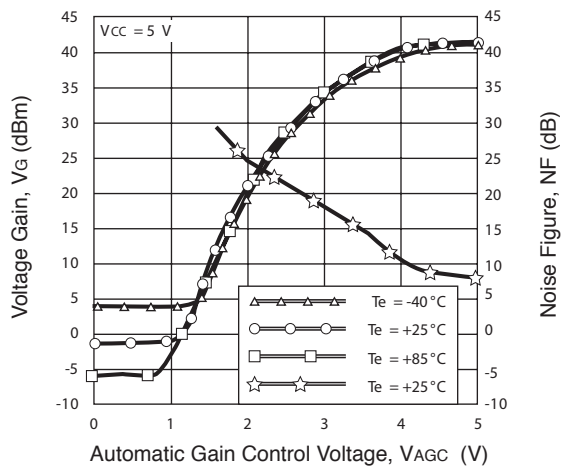

NOISE FIGURE vs. FREQUENCY

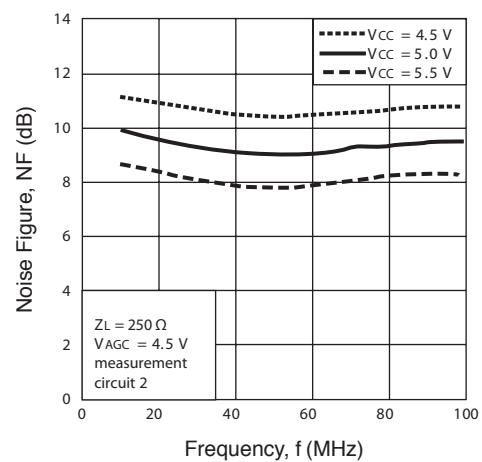

SYSTEM APPLICATION EXAMPLE

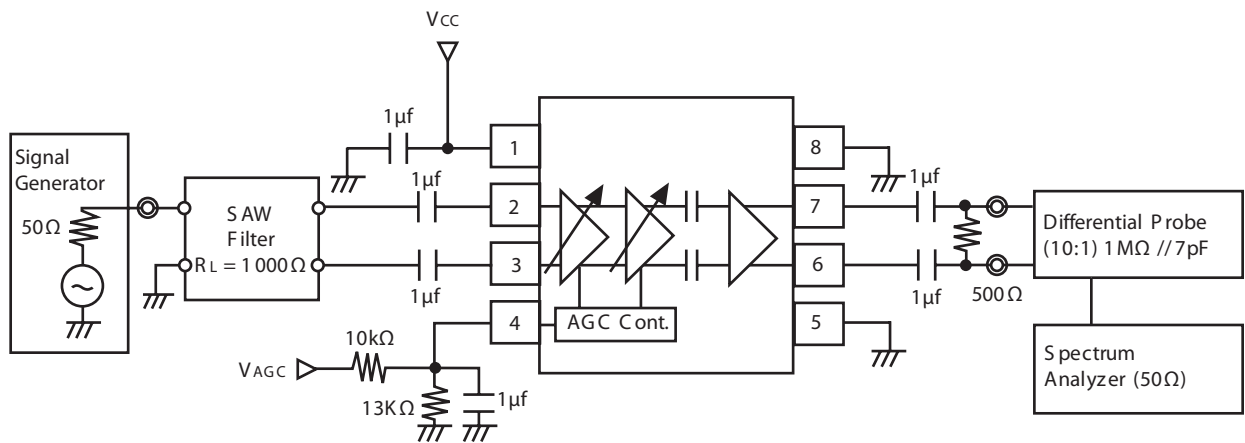

EVALUATION BOARD SCHEMATIC AND TEST

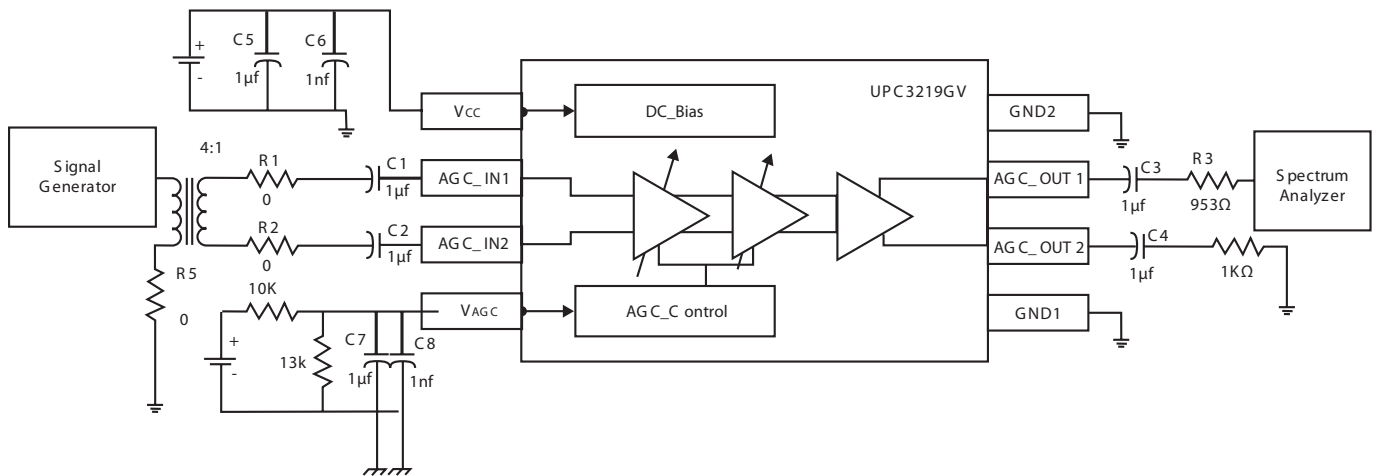

PIN EXPLANATIONS

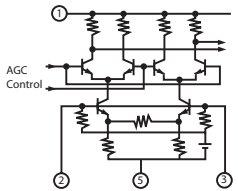
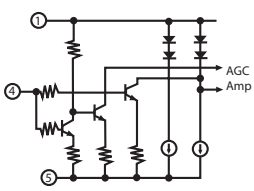
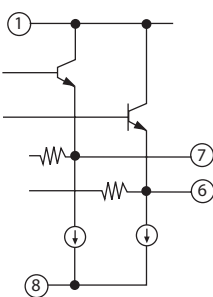
Pin No.	Name	Applied Voltage (v)	Pin Voltage (v) ¹	Description	Internal Equivalent Circuit
1	Vcc	4.5 to 5.5		Power supply pin. This pin should be externally equipped with bypass capacitor to minimize ground impedance.	
2	INPUT1		1.45	Signal input pins of AGC amplifier.	
3	INPUT2		1.45		
4	VAGC	0 to Vcc		Gain control pin. This pin's bias govern the AGC output level. Minimum Gain at V _{AGC} = 0.5 V Maximum Gain at V _{AGC} = 4.5 V Recommended to use by dividing AGC voltage with external resistor (ex. 100k)	
5	GND 2	0		Ground pin. This pin should be connected to system ground with minimum inductance. Ground pattern on the board should be formed as wide as possible.	
6	OUTPUT2		2.2	Signal output pins of video amplifier	
7	OUTPUT1		2.2		
8	GND 1	0		Ground pin. This pin should be connected to system ground with minimum inductance. Ground pattern on the board should be formed as wide as possible. All ground pins must be connected together with wide ground pattern to decrease impedance difference.	

Note:

1. P_{IN} is measured at V_{CC} = 5 V

OUTLINE DIMENSIONS (Units in mm)

PACKAGE OUTLINE S08

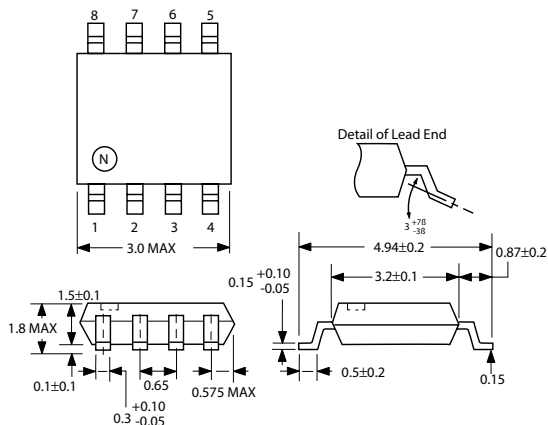

All dimensions are typical unless specified otherwise.

EVALUATION BOARD

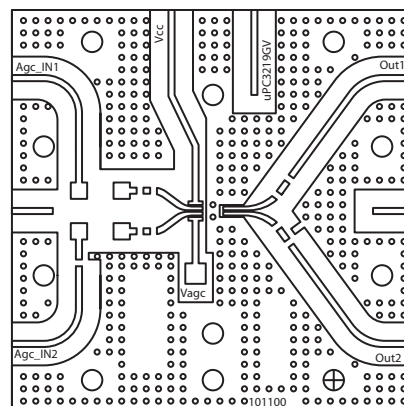

EVALUATION BOARD ASSEMBLY

INTERNAL BLOCK DIAGRAM

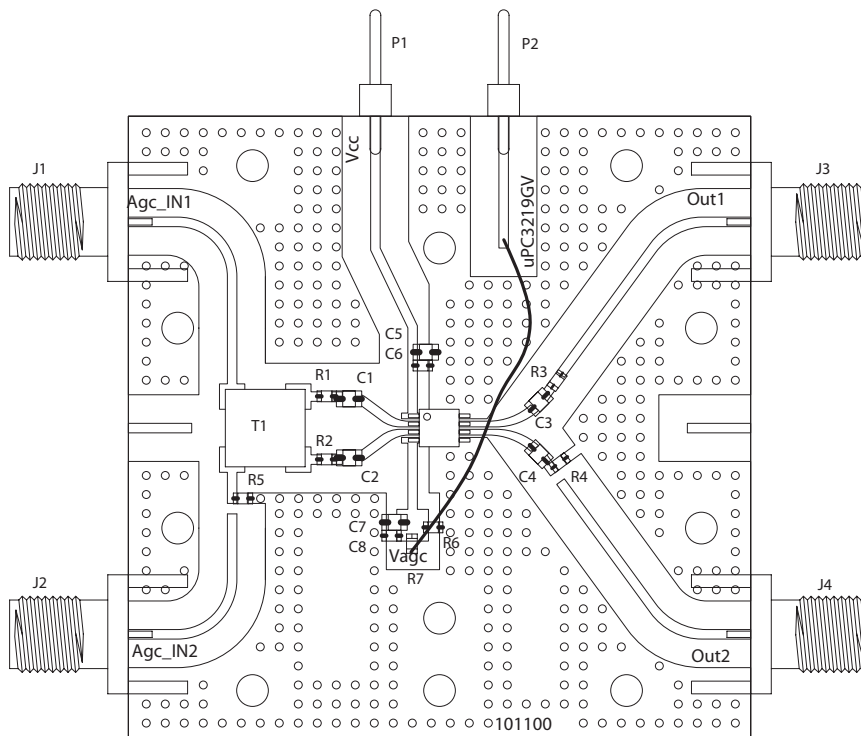
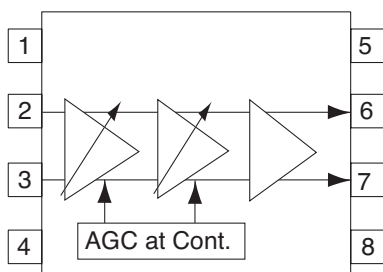

T1	Transformer 4:1 Coilcraft
R7	0603 10K OHM RES ROHM
R6	0603 13K OHM RES ROHM
R4	0603 1K OHM RES ROHM
R3	0603 953 OHM RES ROHM
R1,R2,R5	0603 0 OHM RES ROHM
C6, C8	0603 1000pF CAP ROHM
C1-C5, C7	0805 1uF CAP ROHM
U1	IC NEC, UPC3219GV IC NEC

Life Support Applications

These NEC products are not intended for use in life support devices, appliances, or systems where the malfunction of these products can reasonably be expected to result in personal injury. The customers of CEL using or selling these products for use in such applications do so at their own risk and agree to fully indemnify CEL for all damages resulting from such improper use or sale.

Subject: Compliance with EU Directives

CEL certifies, to its knowledge, that semiconductor and laser products detailed below are compliant with the requirements of European Union (EU) Directive 2002/95/EC Restriction on Use of Hazardous Substances in electrical and electronic equipment (RoHS) and the requirements of EU Directive 2003/11/EC Restriction on Penta and Octa BDE.

CEL Pb-free products have the same base part number with a suffix added. The suffix -A indicates that the device is Pb-free. The -AZ suffix is used to designate devices containing Pb which are exempted from the requirement of RoHS directive (*). In all cases the devices have Pb-free terminals. All devices with these suffixes meet the requirements of the RoHS directive.

This status is based on CEL's understanding of the EU Directives and knowledge of the materials that go into its products as of the date of disclosure of this information.

Restricted Substance per RoHS	Concentration Limit per RoHS (values are not yet fixed)	Concentration contained in CEL devices	
		-A	-AZ
Lead (Pb)	< 1000 PPM	Not Detected	(*)
Mercury	< 1000 PPM	Not Detected	
Cadmium	< 100 PPM	Not Detected	
Hexavalent Chromium	< 1000 PPM	Not Detected	
PBB	< 1000 PPM	Not Detected	
PBDE	< 1000 PPM	Not Detected	

If you should have any additional questions regarding our devices and compliance to environmental standards, please do not hesitate to contact your local representative.

Important Information and Disclaimer: Information provided by CEL on its website or in other communications concerning the substance content of its products represents knowledge and belief as of the date that it is provided. CEL bases its knowledge and belief on information provided by third parties and makes no representation or warranty as to the accuracy of such information. Efforts are underway to better integrate information from third parties. CEL has taken and continues to take reasonable steps to provide representative and accurate information but may not have conducted destructive testing or chemical analysis on incoming materials and chemicals. CEL and CEL suppliers consider certain information to be proprietary, and thus CAS numbers and other limited information may not be available for release.

In no event shall CEL's liability arising out of such information exceed the total purchase price of the CEL part(s) at issue sold by CEL to customer on an annual basis.

See CEL Terms and Conditions for additional clarification of warranties and liability.

Mouser Electronics

Authorized Distributor

Click to View Pricing, Inventory, Delivery & Lifecycle Information:

[CEL:](#)

[UPC2762TB-E3-A](#) [UPC3219GV-EVAL](#)