

4855452 INTERNATIONAL RECTIFIER

55C 04915 D

Data Sheet No. PD-2.009D

T-01-17

INTERNATIONAL RECTIFIER 

6F, 12F, 12F-B, 16F SERIES

6, 12 and 16 Amp Diffused Silicon Rectifier Diodes

Major Ratings and Characteristics

	6F...	12F...	12F-B	16F...	Units
$I_F(AV)$	6	12	12	16	A
@ Max. T_C	158	144	146	140	$^{\circ}C$
I_{FSM}	50Hz	134	225	285	A
	60Hz	141	235	300	A
I^2t	50Hz	90	247	405	A^2s
	60Hz	82	226	370	A^2s
$I^2\sqrt{t}$	1270	3580	4031	6150	$A^2\sqrt{s}$
V_{RRM}	100 to 1200				V
T_J	-65 to 175				$^{\circ}C$

Description

This range of low power general purpose rectifier diodes is designed for battery chargers, converters, power supplies, machine tool controls.

Features

- Wide current range
- High surge capabilities
- Types up to 1200V V_{RRM}
- Stud cathode and stud anode versions
- Avalanche types available

B

CASE STYLE AND DIMENSIONS

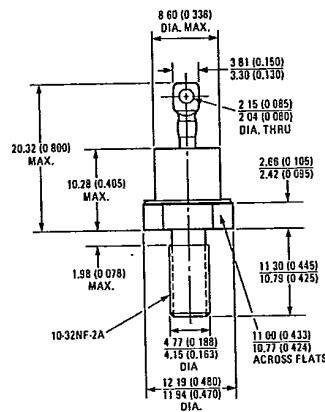
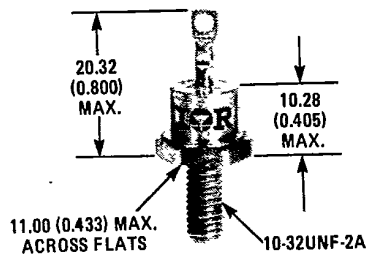

Conforms to JEDEC Outline DO-203AA (DO-4)
Dimensions in Millimeters and (Inches)

4855452 INTERNATIONAL RECTIFIER

55C 04916 D

6F, 12F, 12F-B, 16F Series

INTERNATIONAL RECTIFIER 

T-01-17

REVERSE VOLTAGE RATINGS

① Part Number				V _{RRM} , Maximum peak repetitive reverse voltage, T _J = 175°C	V _{RSM} , Maximum peak non-repetitive reverse voltage, T _J = 175°C	I _{RM} , Maximum peak reverse leakage current at rated V _{RRM} , T _J = 175°C	V _(BR) ^a - Maximum avalanche voltage
				V	V	mA	V
6F10	12F10	12F10B	16F10	100	150	12	-
6F20	12F20	12F20B	16F20	200	275	12	-
6F40	12F40	12F40B	16F40	400	500	12	500
6F60	12F60	12F60B	16F60	600	725	12	750
6F80	12F80	12F80B	16F80	800	950	12	950
6F100	12F100	12F100B	16F100	1000	1200	12	1150
6F120	12F120	12F120B	16F120	1200	1400	12	1350

^a Avalanche versions only available from 400 to 1200 V V_{RRM}

① Types listed are cathode case, for anode case include "R" in code i.e. 6FR10, 12FR20, 16FR40.

AVALANCHE RATINGS

Avalanche versions available with the following reverse power ratings, to specify add 'A' prefix e.g. A6F40, A12F120 etc. N.B. All other parameters are the same as 6F, 12F and 16F.

	A6F...	A12F...	A12F-B	A16F...	Units	Conditions
P _R Maximum non-repetitive peak reverse power	4	7	-	15	kW	10/μs square pulse, T _J = T _J max

ELECTRICAL SPECIFICATIONS

	6F...	12F...	12F-B	16F...	Units	Conditions
I _{F(AV)} Maximum average forward current @ T _C ^a	6 158	12 144	12 146	16 140	A °C	180° conduction, half sine wave
I _{F(RMS)} Maximum rms forward current	9.5	19	19	25	A	
I _{FSM} Maximum peak one cycle non-repetitive current	134	225	285	295	A	t = 10ms No voltage reapplied
	141	235	300	310	A	t = 8.3ms
	159	265	240	350	A	t = 10ms 100% rated V _{RRM} reapplied
	167	280	250	370	A	t = 8.3ms
I ² t Maximum I ² t for fusing	90	247	405	435	A ² s	t = 10ms No voltage reapplied
	82	226	370	395	A ² s	t = 8.3ms
	127	351	285	612	A ² s	t = 10ms 100% rated V _{RRM} reapplied
	116	320	265	560	A ² s	t = 8.3ms
① I ² /t Maximum I ² /t for Ind. dev. fusing	1270	3511	4031	6125	A ² /s	t = 0.1 - 10ms No voltage reapplied
	1.10	1.26	1.20	1.23	V	T _J = 25°C I _{FM} = 7x rated I _{F(AV)}
V _{FM} Maximum peak forward voltage	1.10	1.26	1.20	1.23	V	T _J = 25°C I _{FM} = 7x rated I _{F(AV)}
V _{F(TO)} Maximum value of threshold voltage	0.60	0.68	-	0.78	V	T _J = 175°C
r _F Maximum value of forward slope resistance	17.20	13.51	-	7.55	mΩ	

① I²t for time t_x = I²√t_x + √t_x

THERMAL AND MECHANICAL SPECIFICATIONS

	6F...	12F & A12F-B	16F...	Units	Conditions
T _J Junction operating temp. range	-65 to 175 (1)			°C	
T _{stg} Storage temp. range	-65 to 200			°C	
R _{thJC} Maximum internal thermal resistance, junction to case	2.5	2.0	1.6	K/W	DC operation
R _{thCS} Maximum thermal resistance case to heatsink	0.5			K/W	Mounting surface flat, smooth and greased
T Mounting torque ± 10%	to nut	10.5 (13.5)		lbf.in	Lubricated threads (non-lubricated threads)
		0.12 (0.16)		kgf.m	
	to device	1.2 (1.5)		N.m	
		11.5		lbf.in	
		0.13		kgf.m	
wt Approximate weight	7		g.		
	0.25		oz.		
Case style	DO-203AA (DO-4)				JEDEC

4855452 INTERNATIONAL RECTIFIER

55C 04917 D



6F, 12F, 12F-B, 16F Series

T-01-17

6F Series

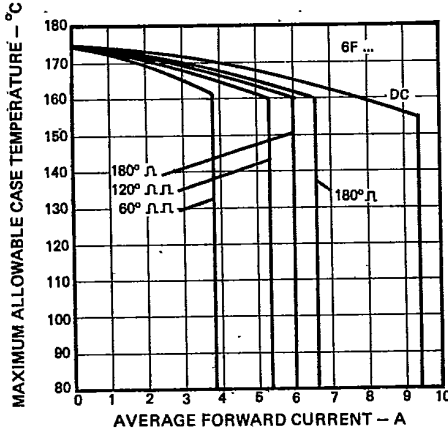

Fig. 1 - Average Forward Current Vs. Maximum Allowable Case Temperature, 6F Series

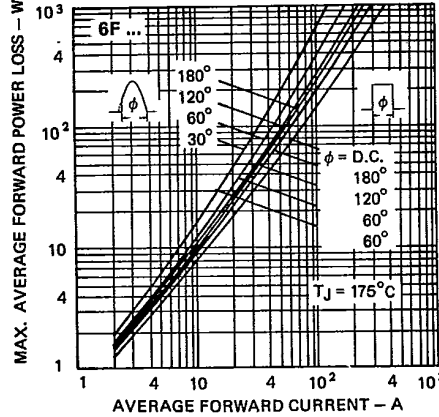

Fig. 2 - Maximum Forward Power Loss Vs. Average Forward Current, 6F Series

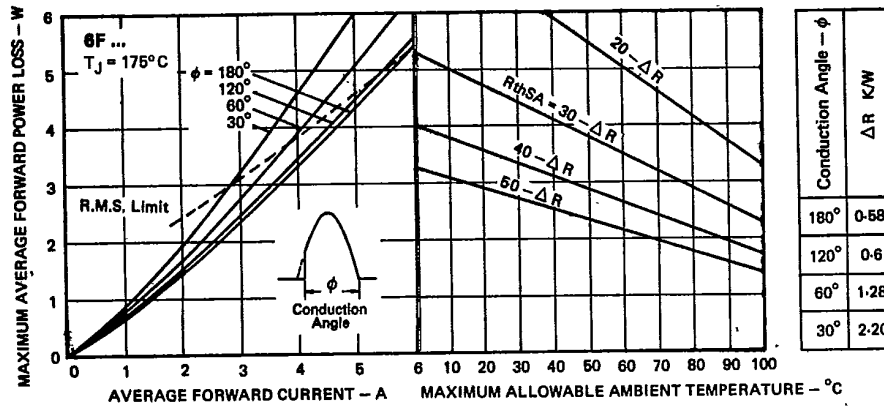

Fig. 3 - Current Rating Nomogram (Sinusoidal Waveforms), 6F Series

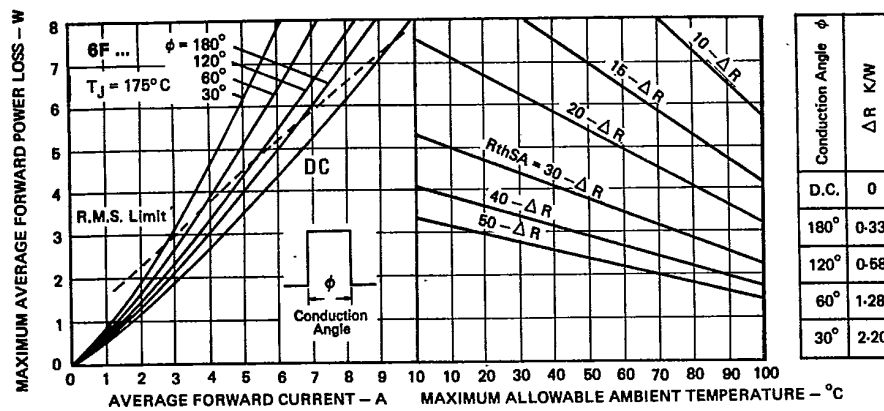

Fig. 4 - Current Rating Nomogram (Rectangular Waveforms), 6F Series

B

4855452 INTERNATIONAL RECTIFIER

55C 04918 D

6F, 12F, 12F-B, 16F Series

INTERNATIONAL RECTIFIER **IR**

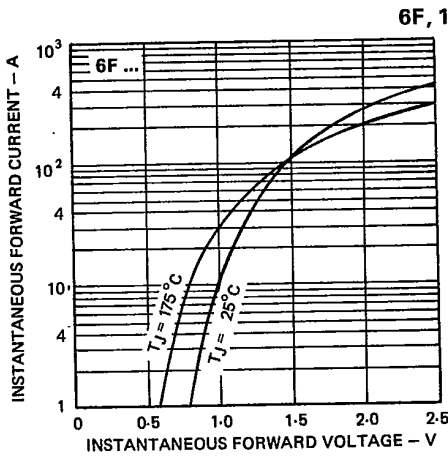

Fig. 5 - Maximum Forward Voltage Vs. Forward Current, 6F Series

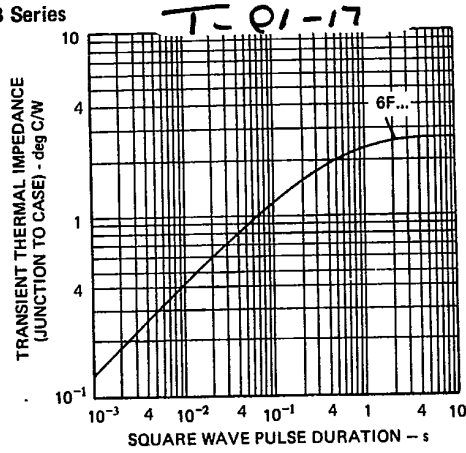

Fig. 6 - Maximum Transient Thermal Impedance, Junction-to-Case Vs. Pulse Duration, 6F Series

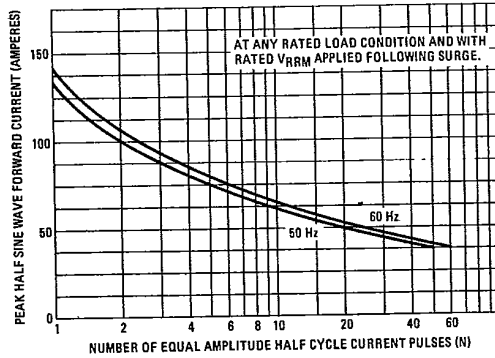

Fig. 7 - Maximum Non-Repetitive Surge Current Vs. Number of Current Pulses, 6F Series

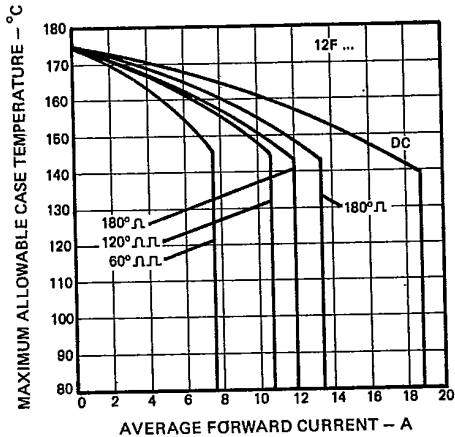

Fig. 8 - Average Forward Current Vs. Maximum Allowable Case Temperature, 12F Series

Note: add 2°C to above curves at full rated load for 12F-B series.

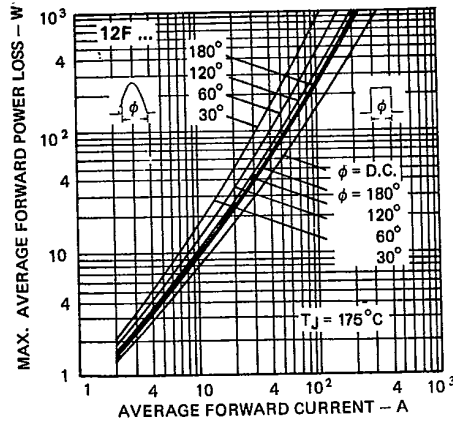

Fig. 9 - Maximum Forward Power Loss Vs. Average Forward Current, 12F Series

Note: subtract 3 percent from above curves at full rated load for 12F-B series.

4855452 INTERNATIONAL RECTIFIER

55C 04919 D



6F, 12F, 12F-B, 16F Series

T-01-17

12F and 12F-B Series

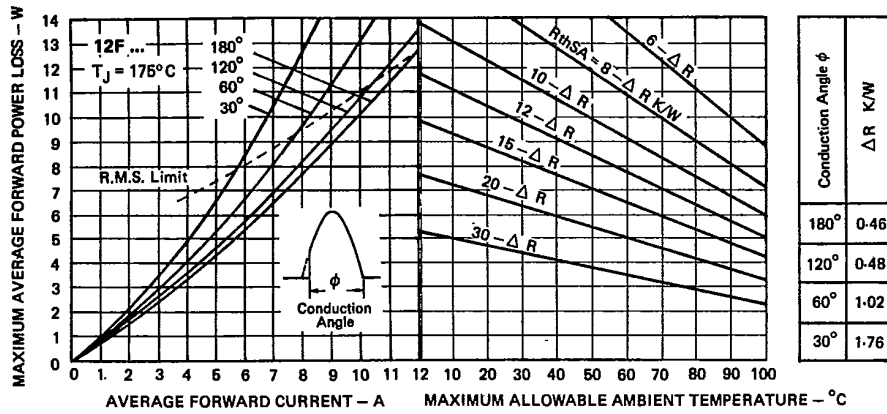

Fig. 10 - Current Rating Nomogram (Sinusoidal Waveform), 12F and 12F-B Series.

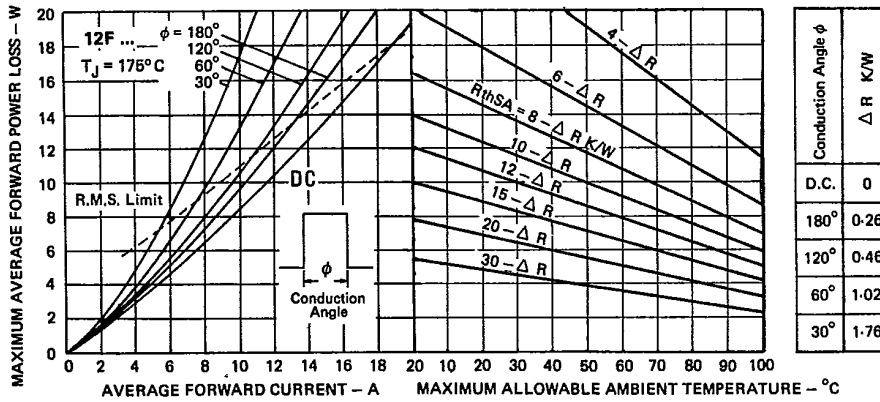

Fig. 11 - Current Rating Nomogram (Rectangular Waveforms), 12F and 12F-B Series.

4855452 INTERNATIONAL RECTIFIER

55C 04920 D

6F, 12F, 12F-B, 16F Series

INTERNATIONAL RECTIFIER 

12F, 12F-B and 16F Series

T-01-17

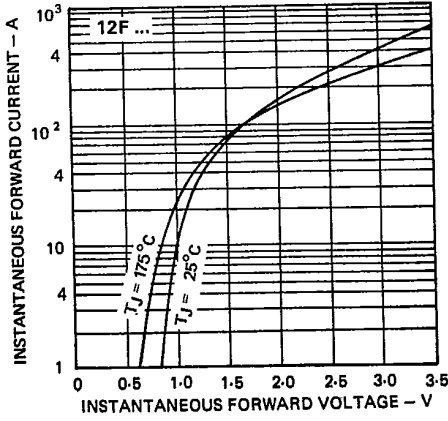

Fig. 12 - Maximum Forward Voltage Vs. Forward Current, 12F Series

Note: subtract 0.06V at 38A for 12F-B Series.

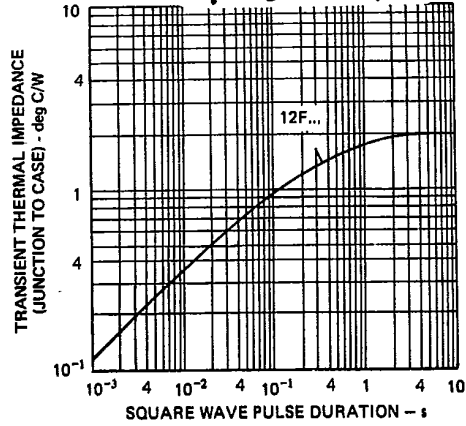

Fig. 13 - Maximum Transient Thermal Impedance, Junction-to-Case Vs. Pulse Duration, 12F and 12F-B Series

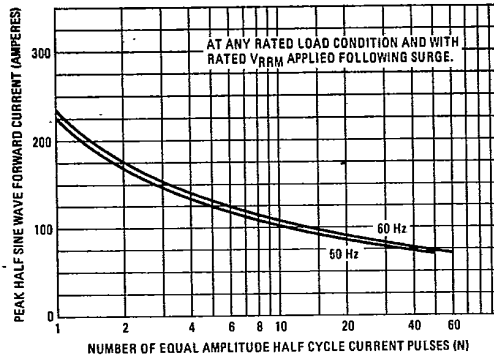

Fig. 14 - Maximum Non-Repetitive Surge Current Vs. Number of Current Pulses, 12F Series

Note: 12F-B ratings are 11 percent higher at one cycle and 5 percent higher at 50 and 60 cycles.

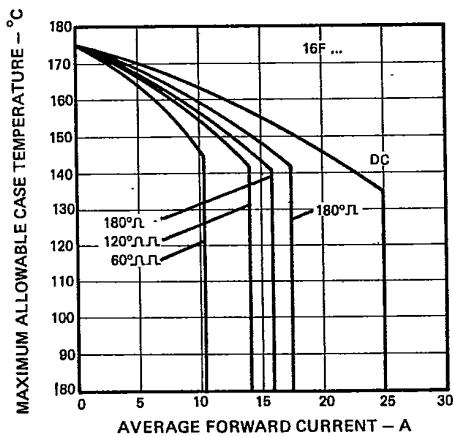

Fig. 15 - Average Forward Current Vs. Maximum Allowable Case Temperature, 16F Series

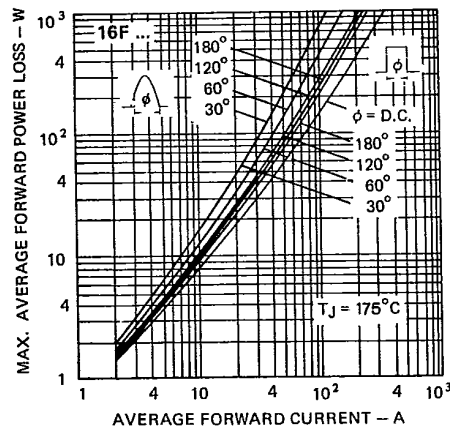

Fig. 16 - Maximum Forward Power Loss Vs. Average Forward Current, 16F Series

4855452 INTERNATIONAL RECTIFIER

55C 04921 D



6F, 12F, 12F-B, 16F Series

T-01-17

16F Series

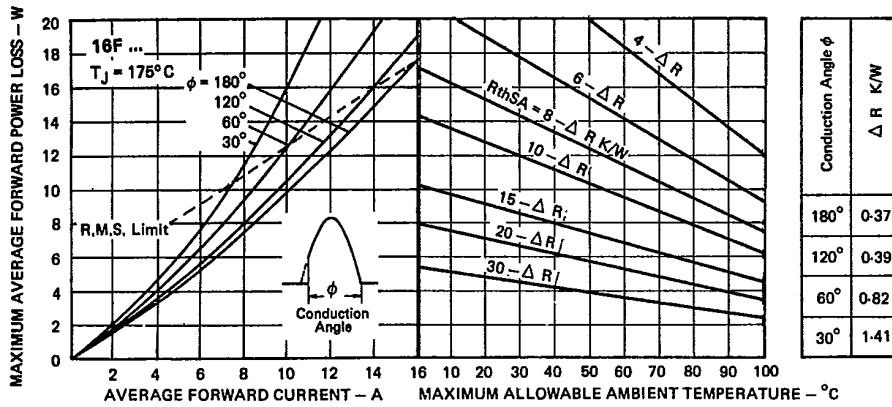

Fig. 17 - Current Rating Nomogram (Sinusoidal Waveforms), 16F Series

B

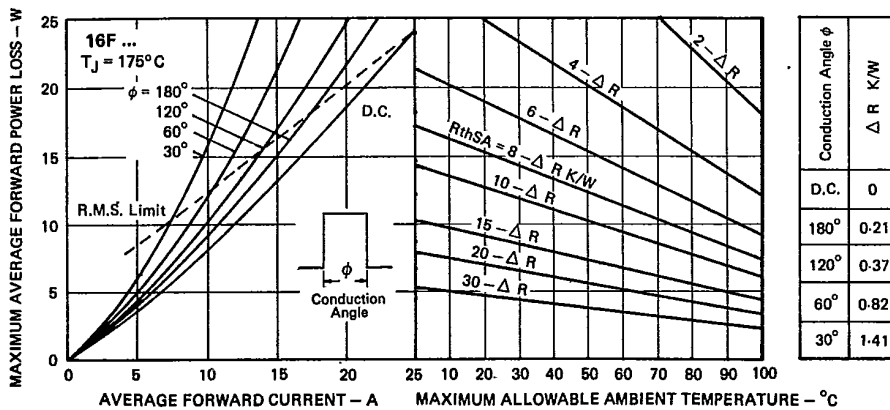

Fig. 18 - Current Rating Nomogram (Rectangular Waveforms), 16F Series

4855452 INTERNATIONAL RECTIFIER

55C 04922 D

6F, 12F, 12F-B, 16F Series

INTERNATIONAL RECTIFIER 

16F Series

T-01-17

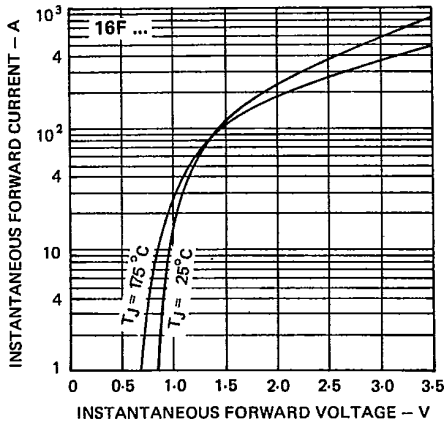

Fig. 19 - Maximum Forward Voltage Vs. Forward Current, 16F Series

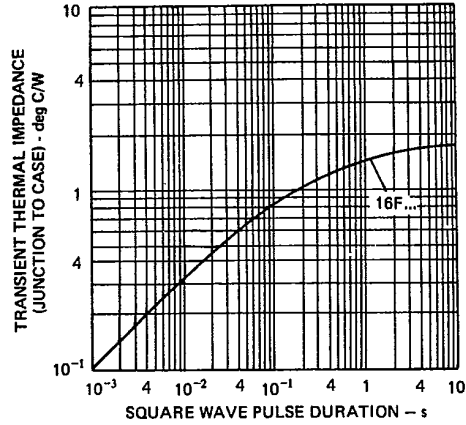

Fig. 20 - Maximum Transient Thermal Impedance, Junction-to-Case Vs. Pulse Duration, 16F Series

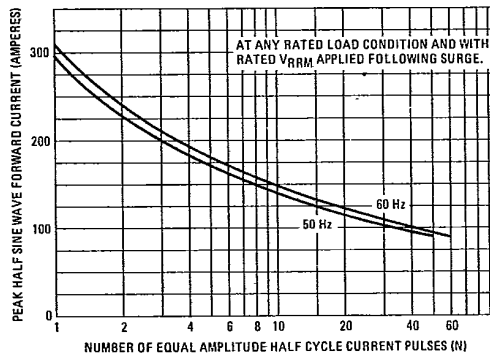

Fig. 21 - Maximum Non-Repetitive Surge Current Vs. Number of Current Pulses, 16F Series