

Ceramic

# Bandpass Filter

**BFTC-500+**

50Ω

400 to 600 MHz

## The Big Deal

- LTCC construction
- Temperature stable from -40°C to +85°C
- Small size (0.150 x 0.150 x 0.059")



*Generic photo used for illustration purposes only*  
CASE STYLE: FR933-1

## Product Overview

The BFTC-500+ LTCC bandpass filter covers the 400 to 600 MHz passband with 25 dB upper/lower stopband rejection. This model handles up to 4W RF input power and provides a wide operating temperature range from -40 to +85°C. Utilizing LTCC multi-layer construction, the filter achieves excellent repeatability of performance and comes in a tiny ceramic package saving space in dense PCB layouts.

## Key Features

Feature	Advantages
LTCC Construction	Provides a rugged package well suited for tough environments such as high humidity and temperature extremes.
Tiny size (0.150 x 0.150 x 0.059")	Saves space in dense circuit boards and minimizes the effects of parasitics.
Wide operating temperature range, -40 to +85°C	Enables reliable performance in extreme environments

### Notes

- A. Performance and quality attributes and conditions not expressly stated in this specification document are intended to be excluded and do not form a part of this specification document.  
B. Electrical specifications and performance data contained in this specification document are based on Mini-Circuit's applicable established test performance criteria and measurement instructions.  
C. The parts covered by this specification document are subject to Mini-Circuits standard limited warranty and terms and conditions (collectively, "Standard Terms"); Purchasers of this part are entitled to the rights and benefits contained therein. For a full statement of the Standard Terms and the exclusive rights and remedies thereunder, please visit Mini-Circuits' website at [www.minicircuits.com/MCLStore/terms.jsp](http://www.minicircuits.com/MCLStore/terms.jsp)



# Ceramic Bandpass Filter

## BFTC-500+

50Ω 400 to 600 MHz



Generic photo used for illustration purposes only  
CASE STYLE: FR933-1

### Features

- Good VSWR 1.5 typ. @ passband
- Small size
- Hermetically sealed
- Temperature stable
- LTCC construction

### Applications

- Test and measurement
- Harmonic rejection
- Transmitters / Receivers

### Electrical Specifications<sup>1,2</sup> at 25°C

Parameter	F#	Frequency (MHz)	Min.	Typ.	Max.	Unit
Pass Band	Center Frequency	—	—	500	—	MHz
	Insertion Loss	F1-F2	—	4.0	5.5	dB
	VSWR	F1-F2	400-600	—	1.5	:1
Stop Band, Lower	Insertion Loss	F3-F4	1-290	25	38	dB
	VSWR	F3-F4	1-290	—	12	:1
Stop Band, Upper	Insertion Loss	F5-F6	800-2000	25	33	dB
	VSWR	F5-F6	800-2000	—	10	:1

1. Measured on Mini-Circuits Characterization Test Board TB-233

2. This filter is not intended for use as a DC Blocking circuit element. In Application where DC voltage is present at either input or output ports, blocking capacitors are required at the corresponding RF port.

### Maximum Ratings

Operating Temperature	-40°C to 85°C
Storage Temperature	-55°C to 100°C
RF Power Input*	4W max @ +25°C

\*Passband rating, derate linearly to 2W at 85°C ambient

Permanent damage may occur if any of these limits are exceeded.

### Functional Schematic

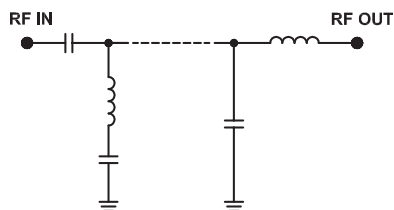

### Typical Frequency Response

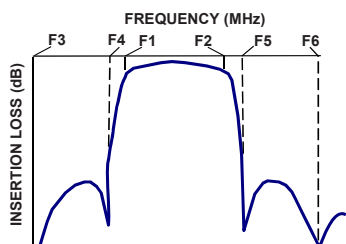

### Typical Performance Data at 25°C

Frequency (MHz)	Insertion Loss (dB)	VSWR (:1)	Frequency (MHz)	Group Delay (nsec)
1	81.10	8132.47	400	5.92
10	61.02	2957.25	410	5.30
100	43.72	80.76	420	4.85
290	45.49	11.16	430	4.51
310	30.87	8.78	440	4.25
330	20.48	6.29	450	4.04
350	11.75	3.66	460	3.88
400	3.12	1.27	470	3.76
500	2.28	1.02	480	3.66
600	3.60	1.09	490	3.58
680	12.69	4.22	500	3.53
720	20.44	6.04	510	3.49
776	30.89	7.20	520	3.48
800	34.64	7.57	530	3.48
900	49.71	10.12	540	3.49
1000	40.57	15.32	550	3.53
1250	33.01	30.89	560	3.60
1500	34.78	40.48	570	3.70
1750	41.47	46.67	580	3.83
2000	45.96	48.51	600	4.16

### +RoHS Compliant

The +Suffix identifies RoHS Compliance. See our web site for RoHS Compliance methodologies and qualifications

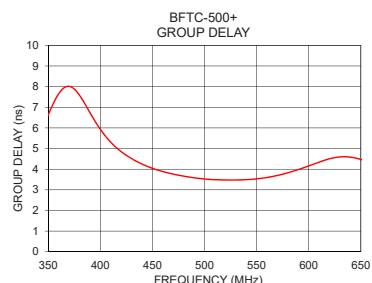
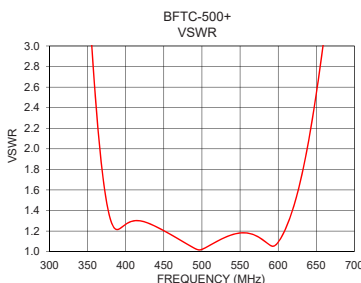
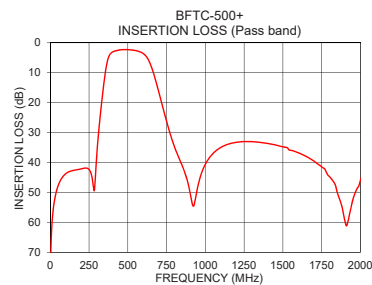
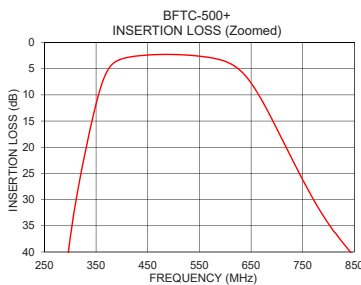

### Notes

- Performance and quality attributes and conditions not expressly stated in this specification document are intended to be excluded and do not form a part of this specification document.
- Electrical specifications and performance data contained in this specification document are based on Mini-Circuit's applicable established test performance criteria and measurement instructions.
- The parts covered by this specification document are subject to Mini-Circuits standard limited warranty and terms and conditions (collectively, "Standard Terms"); Purchasers of this part are entitled to the rights and benefits contained therein. For a full statement of the Standard Terms and the exclusive rights and remedies thereunder, please visit Mini-Circuits' website at [www.minicircuits.com/MCLStore/terms.jsp](http://www.minicircuits.com/MCLStore/terms.jsp)



## Pad Connections

RF IN	2
RF OUT	5
GROUND	1,3,4,6

**Demo Board MCL P/N: TB-233**  
**Suggested PCB Layout (PL-112)**

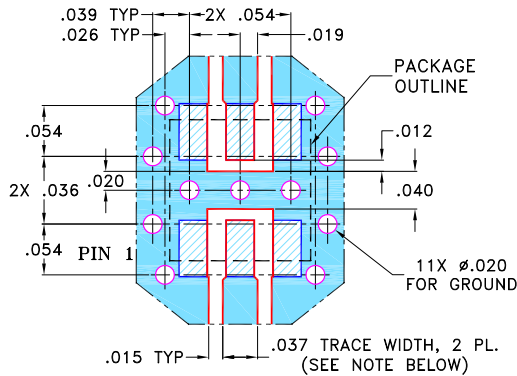

NOTES: 1. TRACE WIDTH IS SHOWN FOR ROGERS R04350B WITH DIELECTRIC THICKNESS  $0.020" \pm 0.0015"$ ; COPPER: 1/2 OZ. EACH SIDE. FOR OTHER MATERIALS TRACE WIDTH MAY NEED TO BE MODIFIED.

2. BOTTOM SIDE OF THE PCB IS CONTINUOUS GROUND PLANE.

- DENOTES PCB COPPER LAYOUT WITH SMOBC (SOLDER MASK OVER BARE COPPER)
- DENOTES COPPER LAND PATTERN FREE OF SOLDER MASK

## Outline Drawing

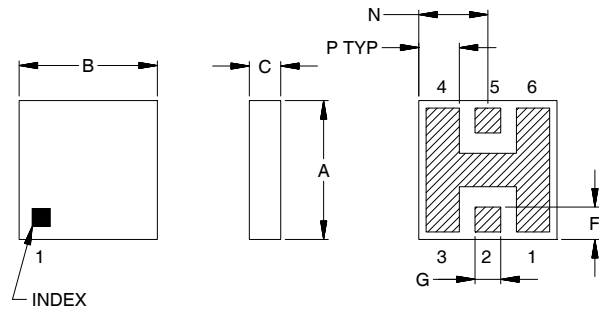

## PCB Land Pattern

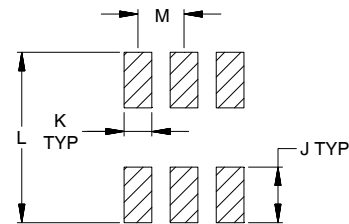

**Suggested Layout,**  
 Tolerance to be within  $\pm .002$

## Outline Dimensions (inch/mm)

A	B	C	D	E	F	G	H
.150	.150	.059	--	--	.035	.028	--
3.81	3.81	1.50	--	--	.89	.71	--
J	K	L	M	N	P	Wt.	
.060	.030	.184	.050	.075	.044	grams	
1.52	.76	4.67	1.27	1.91	1.12	0.15	

*Note: Please refer to case style drawing for details*

### Notes

- A. Performance and quality attributes and conditions not expressly stated in this specification document are intended to be excluded and do not form a part of this specification document.
- B. Electrical specifications and performance data contained in this specification document are based on Mini-Circuit's applicable established test performance criteria and measurement instructions.
- C. The parts covered by this specification document are subject to Mini-Circuits standard limited warranty and terms and conditions (collectively, "Standard Terms"); Purchasers of this part are entitled to the rights and benefits contained therein. For a full statement of the Standard Terms and the exclusive rights and remedies thereunder, please visit Mini-Circuits' website at [www.minicircuits.com/MCLStore/terms.jsp](http://www.minicircuits.com/MCLStore/terms.jsp)