

Surface Mount

Monolithic Amplifier

DC-1 GHz

Features

- InGaP HBT IF and RF amplifier
- Frequency range, DC to 1 GHz
- High gain, 25.1 dB typ. at 0.1 GHz
- Internally Matched to 50 Ohms
- +19.2 dBm typ. output power at 0.1 GHz
- High IP3, +38 dBm at 0.1 GHz
- Low noise figure, 2.7 dB typ.
- Unconditionally stable
- Low thermal resistance
- Transient protected
- Aqueous washable
- Protected by US patent, 6,943,629

Applications

- Cellular
- Broadband
- Communication receivers & transmitters

General Description

Gali₇₄₊ (RoHS compliant) is a wideband amplifier offering high dynamic range. It has repeatable performance from lot to lot, and is enclosed in a SOT-89 package. It uses patented Transient Protected Darlington configuration and is fabricated using InGaP HBT technology. Expected MTTF is 500 years at 85°C case temperature. Gali₇₄₊ is designed to be rugged for ESD and supply switch-on transients.



Generic photo used for illustration purposes only

Gali₇₄₊

CASE STYLE: DF782

+RoHS Compliant

The +Suffix identifies RoHS Compliance. See our web site for RoHS Compliance methodologies and qualifications

simplified schematic and pin description

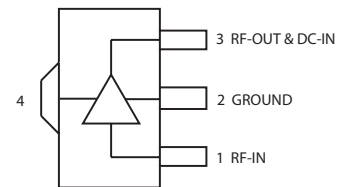
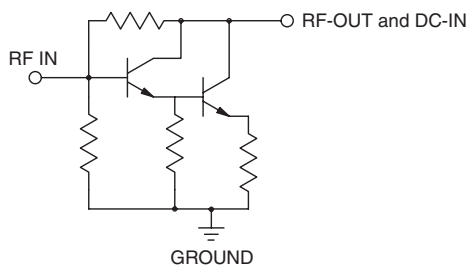

Function	Pin Number	Description
RF IN	1	RF input pin. This pin requires the use of an external DC blocking capacitor chosen for the frequency of operation.
RF-OUT and DC-IN	3	RF output and bias pin. DC voltage is present on this pin; therefore a DC blocking capacitor is necessary for proper operation. An RF choke is needed to feed DC bias without loss of RF signal due to the bias connection, as shown in "Recommended Application Circuit".
GND	2,4	Connections to ground. Use via holes as shown in "Suggested Layout for PCB Design" to reduce ground path inductance for best performance.

Notes

- Performance and quality attributes and conditions not expressly stated in this specification document are intended to be excluded and do not form a part of this specification document.
- Electrical specifications and performance data contained in this specification document are based on Mini-Circuit's applicable established test performance criteria and measurement instructions.
- The parts covered by this specification document are subject to Mini-Circuits' standard limited warranty and terms and conditions (collectively, "Standard Terms"); Purchasers of this part are entitled to the rights and benefits contained therein. For a full statement of the Standard Terms and the exclusive rights and remedies thereunder, please visit Mini-Circuits' website at www.minicircuits.com/MCLStore/terms.jsp



Electrical Specifications at 25°C and 80mA, unless noted

Parameter		Min.	Typ.	Max.	Units
Frequency Range*		DC		1	GHz
Gain	f=0.1 GHz	—	25.1	—	dB
	f=1 GHz	20	21.8	—	
	f=2 GHz	—	18.0	—	
	f=3 GHz	—	15.3	—	
	f=4 GHz	—	13.4	—	
Input Return Loss	f= DC to 1 GHz		21		dB
Output Return Loss	f= DC to 1 GHz		12.5		dB
Output Power @ 1 dB compression	f=0.1 GHz	18	19.2	—	dBm
	f=0.5 GHz	—	19	—	
	f=1.0 GHz	—	18.3	—	
Output IP3	f=0.1 GHz		38		dBm
	f=0.5 GHz		37		
	f=1.0 GHz		33		
Noise Figure			2.7		dB
Recommended Device Operating Current			80		mA
Device Operating Voltage		4.3	4.8	5.3	V
Device Voltage Variation vs. Temperature at 80 mA			-3.1		mV/°C
Device Voltage Variation vs. Current at 25°C			2.8		mV/mA
Thermal Resistance, junction-to-case ¹			120		°C/W

*Guaranteed specification DC-1 GHz. Low frequency cut off determined by external coupling capacitors.

Absolute Maximum Ratings

Parameter	Ratings
Operating Temperature*	-45°C to 85°C
Storage Temperature	-65°C to 150°C
Operating Current	130mA
Input Power	10dBm

Note: Permanent damage may occur if any of these limits are exceeded.

These ratings are not intended for continuous normal operation.

¹Case is defined as ground leads.

*Based on typical case temperature rise 6°C above ambient.

Notes

- A. Performance and quality attributes and conditions not expressly stated in this specification document are intended to be excluded and do not form a part of this specification document.
- B. Electrical specifications and performance data contained in this specification document are based on Mini-Circuit's applicable established test performance criteria and measurement instructions.
- C. The parts covered by this specification document are subject to Mini-Circuits standard limited warranty and terms and conditions (collectively, "Standard Terms"); Purchasers of this part are entitled to the rights and benefits contained therein. For a full statement of the Standard Terms and the exclusive rights and remedies thereunder, please visit Mini-Circuits' website at www.minicircuits.com/MCLStore/terms.jsp



Product Marking

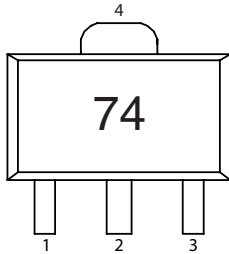

Markings in addition to model number designation may appear for internal quality control purposes.

Additional Detailed Technical Information

Additional information is available on our web site. To access this information enter the model number on our web site home page.

Performance data, graphs, s-parameter data set (.zip file)

Case Style: DF782

Plastic package, exposed paddle, lead finish: Matte-Tin

Tape & Reel: F55

7" reels with 20, 50, 100, 200, 500, 1K devices.

Suggested Layout for PCB Design: PL-019

Evaluation Board: TB-409-74+

Environmental Ratings: ENV08T2

Recommended Application Circuit

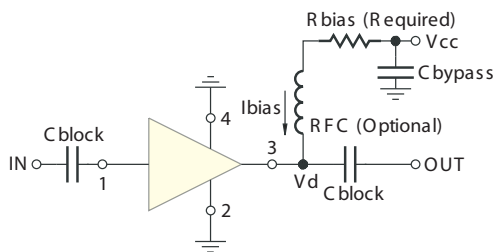

Test Board includes case, connectors, and components (in bold) soldered to PCB

R BIAS	
Vcc	"1%" Res. Values (ohms) for Optimum Biasing
7	28.7
8	41.2
9	53.6
10	66.5
11	78.7
12	90.9
13	102
14	115
15	127

Notes

- A. Performance and quality attributes and conditions not expressly stated in this specification document are intended to be excluded and do not form a part of this specification document.
- B. Electrical specifications and performance data contained in this specification document are based on Mini-Circuit's applicable established test performance criteria and measurement instructions.
- C. The parts covered by this specification document are subject to Mini-Circuits standard limited warranty and terms and conditions (collectively, "Standard Terms"); Purchasers of this part are entitled to the rights and benefits contained therein. For a full statement of the Standard Terms and the exclusive rights and remedies thereunder, please visit Mini-Circuits' website at www.minicircuits.com/MCLStore/terms.jsp



ESD Rating

Human Body Model (HBM): Class 1C (1000v to < 2000v) in accordance with ANSI/ESD STM 5.1 - 2001

Machine Model (MM): Class M2 (100v to < 200v) in accordance with ANSI/ESD STM 5.2 - 1999

MSL Rating

Moisture Sensitivity: MSL1 in accordance with IPC/JEDECJ-STD-020C

No.	Test Required	Condition	Standard	Quantity
1	Visual Inspection	Low Power Microscope Magnification 40x	MIP-IN-0003 (MCT spec)	45 units
2	Electrical Test	Room Temperature	SCD (MCL spec)	45 units
3	SAM Analysis	Less than 10% growth in term of delamination	J-Std-020C (Jedec Standard)	45 units
4	Moisture Sensitivity Level 1	Bake at 125°C for 24 hours Soak at 85°C/85%RH for 168 hours Reflow 3 cycles at 260°C peak	J-Std-020C (Jedec Standard)	45 units

MSL Test Flow Chart



Notes

- A. Performance and quality attributes and conditions not expressly stated in this specification document are intended to be excluded and do not form a part of this specification document.
- B. Electrical specifications and performance data contained in this specification document are based on Mini-Circuit's applicable established test performance criteria and measurement instructions.
- C. The parts covered by this specification document are subject to Mini-Circuits standard limited warranty and terms and conditions (collectively, "Standard Terms"); Purchasers of this part are entitled to the rights and benefits contained therein. For a full statement of the Standard Terms and the exclusive rights and remedies thereunder, please visit Mini-Circuits' website at www.minicircuits.com/MCLStore/terms.jsp



Typical Performance Data

**NOTE: Use PDF Bookmarks to view DATA at required conditions
or to view GRAPHS.**

Definitions:

- Input Return Loss = -S11 (dB)
- Gain(Power Gain) = S21 (dB)
- Reverse Isolation = -S12 (dB)
- Output Return Loss = -S22 (dB)

TEST CONDITIONS: Icc = 80mA, Vd = 4.81V @Temperature = +25degC

FREQ	Gain	Isolation	Input Return Loss	Output Return Loss	Stability		FREQ	IP3 Output	1dB Comp. Output	Noise Figure
(MHz)	(dB)	(dB)	(dB)	(dB)	K	Delta	(MHz)	(dBm)	(dBm)	(dB)
50	25.06	28.07	26.28	16.98	1.05	0.71	50	36.87	19.44	2.66
100	24.98	28.10	25.79	16.72	1.06	0.70	100	36.26	19.71	2.82
200	24.76	28.02	24.65	15.67	1.06	0.69	150	37.07	19.58	2.76
400	24.20	27.89	23.04	13.97	1.06	0.66	200	36.20	19.54	2.66
600	23.53	27.66	22.10	12.70	1.07	0.63	250	35.94	19.56	2.68
800	22.82	27.43	21.36	11.67	1.08	0.59	300	36.06	19.51	2.89
1000	22.04	27.20	20.69	10.97	1.10	0.55	350	36.76	19.57	2.77
1200	21.27	26.94	19.97	10.43	1.12	0.52	400	35.65	19.51	2.73
1400	20.57	26.60	18.80	9.96	1.13	0.49	450	35.88	19.53	2.72
1600	19.82	26.31	17.99	9.70	1.15	0.46	500	34.97	19.51	2.90
1800	19.16	25.95	17.26	9.44	1.16	0.44	550	35.35	19.49	2.90
2000	18.52	25.64	16.19	9.30	1.18	0.42	600	34.59	19.38	2.79
2200	17.92	25.33	15.71	9.23	1.19	0.40	650	34.89	19.36	2.80
2400	17.38	24.99	14.94	9.20	1.20	0.39	700	34.28	19.28	2.94
2600	16.80	24.63	14.35	9.20	1.21	0.38	750	34.35	19.28	2.95
2800	16.31	24.33	13.95	9.20	1.23	0.37	800	33.89	19.29	2.86
3000	15.84	24.08	13.46	9.23	1.24	0.35	850	33.86	19.26	2.77
3200	15.43	23.77	13.05	9.27	1.24	0.35	900	33.61	18.98	2.90
3400	15.01	23.51	12.75	9.28	1.26	0.34	950	33.40	18.97	2.90
3600	14.66	23.30	12.46	9.36	1.27	0.33	1000	33.14	18.95	2.84
3800	14.29	23.08	12.36	9.39	1.28	0.33	1050	32.73	18.81	2.73
4000	13.96	22.85	12.21	9.39	1.29	0.32	1100	32.67	18.85	2.85
4200	13.62	22.64	12.08	9.35	1.31	0.32	1150	32.20	18.49	3.01
4400	13.31	22.48	12.19	9.30	1.33	0.32	1200	32.17	18.57	2.91
4600	13.03	22.31	12.11	9.20	1.34	0.32	1250	31.80	18.27	2.78
5000	12.48	22.13	12.24	8.90	1.38	0.31	1300	31.62	18.33	2.84
5500	11.70	21.98	11.96	8.37	1.45	0.31	1350	31.22	18.09	3.03
6000	10.83	22.02	11.23	7.72	1.55	0.31	1400	31.15	18.02	3.02
6500	9.73	22.12	10.14	7.19	1.69	0.31	1450	30.88	17.74	2.86
7000	8.42	22.29	9.12	6.62	1.88	0.32	1500	30.76	17.73	2.97
7500	6.82	22.33	8.22	6.12	2.11	0.32	1550	30.53	17.42	2.83
8000	5.19	21.81	7.64	5.67	2.26	0.33	1600	30.83	17.40	3.07
8500	3.51	21.08	7.00	5.32	2.37	0.35	1650	30.46	17.07	3.03
9000	1.93	20.07	6.38	5.07	2.38	0.36	1700	30.92	16.94	2.83
10000	-0.51	16.94	5.61	4.96	2.06	0.38	1750	29.83	16.72	2.92
11000	-1.66	13.30	5.80	5.58	1.67	0.37	1800	30.45	16.67	2.99
12000	-1.67	9.38	7.36	7.07	1.36	0.38	1850	29.18	16.46	2.92
13000	-1.54	5.69	9.42	8.76	1.16	0.51	1900	29.99	16.23	2.90
14000	-2.61	4.37	6.70	6.57	1.09	0.64	1950	28.92	16.13	2.95
15000	-4.69	5.29	3.94	4.12	1.10	0.70	2000	29.58	15.90	2.95

REV. X1
GALI-74+
120123
Page 1 of 11



IF/RF MICROWAVE COMPONENTS • ISO 9001 ISO 14001 AS 9100 CERTIFIED • RoHS compliant
P.O. Box 350166, Brooklyn, New York 11235-0003 (718) 934-4500 Fax (718) 332-4661



The Design Engineers Search Engine finds the model you need, Instantly • For detailed performance specs & shopping online see



Typical Performance Data

Definitions:

Input Return Loss = -S11 (dB)

Gain(Power Gain) = S21 (dB)

Reverse Isolation = -S12 (dB)

Output Return Loss = -S22 (dB)

TEST CONDITIONS: Icc = 64mA, Vd = 4.77V @Temperature = +25degC

FREQ	Gain	Isolation	Input Return Loss	Output Return Loss	Stability		FREQ	IP3 Output	1dB Comp. Output	Noise Figure
					K	Delta				
(MHz)	(dB)	(dB)	(dB)	(dB)	K	Delta	(MHz)	(dBm)	(dBm)	(dB)
50	24.82	27.77	31.59	18.75	1.05	0.72	50	33.89	18.31	2.64
100	24.76	27.78	30.57	18.32	1.05	0.71	100	33.34	18.59	2.78
200	24.55	27.74	27.94	16.99	1.05	0.69	150	34.17	18.40	2.70
400	23.99	27.59	24.71	14.83	1.06	0.66	200	33.40	18.39	2.61
600	23.33	27.41	23.04	13.29	1.07	0.62	250	33.35	18.40	2.63
800	22.64	27.18	21.80	12.10	1.08	0.59	300	33.44	18.39	2.83
1000	21.89	26.95	20.74	11.28	1.09	0.55	350	34.22	18.40	2.73
1200	21.13	26.69	19.82	10.68	1.11	0.52	400	33.26	18.41	2.69
1400	20.42	26.35	18.47	10.16	1.12	0.49	450	33.57	18.41	2.65
1600	19.69	26.13	17.65	9.86	1.14	0.46	500	32.92	18.46	2.81
1800	19.02	25.75	16.85	9.59	1.15	0.44	550	33.30	18.37	2.84
2000	18.39	25.46	15.78	9.41	1.17	0.42	600	32.79	18.33	2.73
2200	17.78	25.12	15.30	9.34	1.18	0.40	650	33.09	18.37	2.72
2400	17.23	24.83	14.56	9.32	1.19	0.38	700	32.79	18.32	2.87
2600	16.69	24.50	13.96	9.31	1.20	0.37	750	32.76	18.29	2.89
2800	16.19	24.27	13.58	9.31	1.22	0.36	800	32.56	18.40	2.80
3000	15.71	23.97	13.12	9.33	1.24	0.35	850	32.49	18.29	2.72
3200	15.30	23.65	12.73	9.40	1.24	0.34	900	32.43	18.19	2.82
3400	14.89	23.45	12.46	9.40	1.26	0.33	950	32.19	18.18	2.82
3600	14.53	23.23	12.13	9.49	1.27	0.32	1000	32.08	18.16	2.80
3800	14.15	23.03	12.07	9.55	1.29	0.32	1050	31.71	18.14	2.66
4000	13.85	22.80	11.90	9.52	1.29	0.31	1100	31.67	18.10	2.78
4200	13.50	22.63	11.80	9.51	1.31	0.31	1150	31.27	17.89	2.95
4400	13.18	22.44	11.92	9.46	1.33	0.31	1200	31.24	17.85	2.85
4600	12.90	22.31	11.84	9.36	1.35	0.31	1250	30.96	17.69	2.73
5000	12.34	22.11	11.99	9.10	1.40	0.30	1300	30.77	17.71	2.77
5500	11.56	21.98	11.77	8.59	1.47	0.30	1350	30.42	17.55	2.95
6000	10.68	21.99	11.10	7.94	1.57	0.31	1400	30.32	17.42	2.96
6500	9.58	22.11	10.07	7.43	1.72	0.31	1450	30.10	17.21	2.79
7000	8.27	22.29	9.09	6.85	1.92	0.31	1500	29.99	17.11	2.90
7500	6.70	22.29	8.21	6.31	2.15	0.32	1550	29.81	16.91	2.73
8000	5.08	21.83	7.64	5.84	2.31	0.33	1600	30.05	16.78	2.99
8500	3.41	21.10	7.01	5.47	2.42	0.34	1650	29.78	16.49	2.98
9000	1.84	20.08	6.39	5.21	2.43	0.35	1700	30.16	16.36	2.77
10000	-0.60	16.96	5.62	5.07	2.10	0.38	1750	29.19	16.17	2.84
11000	-1.73	13.35	5.79	5.67	1.69	0.36	1800	29.71	16.09	2.93
12000	-1.75	9.43	7.33	7.15	1.38	0.37	1850	28.56	15.92	2.84
13000	-1.61	5.73	9.38	8.80	1.17	0.50	1900	29.25	15.70	2.80
14000	-2.64	4.37	6.68	6.59	1.10	0.64	1950	28.31	15.59	2.86
15000	-4.70	5.29	3.94	4.13	1.10	0.70	2000	28.87	15.37	2.86

REV. X1
GALI-74+
120123
Page 2 of 11



IF/RF MICROWAVE COMPONENTS • ISO 9001 ISO 14001 AS 9100 CERTIFIED • RoHS compliant
P.O. Box 350166, Brooklyn, New York 11235-0003 (718) 934-4500 Fax (718) 332-4661



The Design Engineers Search Engine finds the model you need, Instantly • For detailed performance specs & shopping online see



Typical Performance Data

Definitions:

Input Return Loss = -S11 (dB)

Gain(Power Gain) = S21 (dB)

Reverse Isolation = -S12 (dB)

Output Return Loss = -S22 (dB)

TEST CONDITIONS: Icc = 96mA, Vd = 4.86V @Temperature = +25degC

FREQ	Gain	Isolation	Input Return Loss	Output Return Loss	Stability		FREQ	IP3 Output	1dB Comp. Output	Noise Figure
					K	Delta				
(MHz)	(dB)	(dB)	(dB)	(dB)	K	Delta	(MHz)	(dBm)	(dBm)	(dB)
50	25.19	28.11	23.94	15.98	1.05	0.72	50	39.05	19.70	2.74
100	25.12	28.28	23.52	15.69	1.05	0.70	100	38.36	19.96	2.92
200	24.90	28.24	22.92	14.94	1.06	0.69	150	38.99	19.94	2.82
400	24.32	28.07	21.87	13.45	1.06	0.66	200	38.01	19.96	2.73
600	23.65	27.91	21.26	12.32	1.08	0.62	250	37.54	20.05	2.76
800	22.92	27.64	20.83	11.39	1.09	0.59	300	37.62	19.99	2.97
1000	22.15	27.38	20.43	10.77	1.11	0.55	350	38.15	20.04	2.85
1200	21.37	27.07	19.89	10.27	1.12	0.52	400	37.04	20.01	2.79
1400	20.66	26.70	18.90	9.82	1.13	0.50	450	37.13	20.02	2.79
1600	19.92	26.45	18.12	9.58	1.16	0.47	500	36.11	19.91	2.98
1800	19.25	26.10	17.47	9.34	1.17	0.45	550	36.40	19.90	2.98
2000	18.62	25.75	16.43	9.21	1.18	0.43	600	35.53	19.78	2.85
2200	18.00	25.37	15.97	9.14	1.19	0.41	650	35.76	19.72	2.85
2400	17.45	25.12	15.23	9.13	1.21	0.39	700	35.04	19.60	3.02
2600	16.91	24.74	14.60	9.11	1.22	0.38	750	35.12	19.61	3.06
2800	16.41	24.46	14.20	9.12	1.23	0.37	800	34.55	19.58	2.92
3000	15.93	24.13	13.72	9.14	1.24	0.36	850	34.56	19.59	2.85
3200	15.52	23.81	13.28	9.21	1.24	0.35	900	34.21	19.25	2.98
3400	15.13	23.57	12.99	9.20	1.25	0.35	950	34.01	19.26	2.97
3600	14.74	23.31	12.67	9.25	1.26	0.34	1000	33.71	19.23	2.90
3800	14.38	23.10	12.60	9.31	1.28	0.33	1050	33.31	19.09	2.80
4000	14.07	22.87	12.43	9.28	1.28	0.33	1100	33.23	19.15	2.94
4200	13.73	22.68	12.30	9.24	1.30	0.33	1150	32.74	18.73	3.09
4400	13.43	22.48	12.41	9.18	1.31	0.33	1200	32.71	18.86	2.96
4600	13.14	22.35	12.31	9.05	1.33	0.32	1250	32.31	18.52	2.86
5000	12.59	22.14	12.41	8.76	1.37	0.32	1300	32.15	18.62	2.95
5500	11.82	21.98	12.09	8.21	1.43	0.32	1350	31.74	18.39	3.12
6000	10.97	22.01	11.33	7.55	1.52	0.32	1400	31.66	18.34	3.08
6500	9.86	22.12	10.19	7.02	1.66	0.32	1450	31.39	18.05	2.92
7000	8.54	22.31	9.15	6.47	1.85	0.33	1500	31.29	18.05	3.04
7500	6.94	22.34	8.22	5.97	2.08	0.33	1550	31.03	17.77	2.89
8000	5.29	21.83	7.65	5.54	2.23	0.34	1600	31.32	17.75	3.13
8500	3.60	21.09	7.00	5.21	2.33	0.35	1650	30.93	17.42	3.09
9000	2.02	20.06	6.38	4.98	2.34	0.37	1700	31.42	17.35	2.93
10000	-0.45	16.91	5.62	4.90	2.04	0.39	1750	30.33	17.10	3.02
11000	-1.60	13.28	5.82	5.51	1.65	0.37	1800	30.99	17.07	3.08
12000	-1.60	9.36	7.39	7.04	1.36	0.38	1850	29.66	16.86	2.97
13000	-1.50	5.68	9.47	8.73	1.16	0.51	1900	30.51	16.65	2.96
14000	-2.58	4.37	6.70	6.54	1.09	0.65	1950	29.40	16.54	3.05
15000	-4.67	5.29	3.95	4.12	1.10	0.70	2000	30.09	16.33	3.04

REV. X1
GALI-74+
120123
Page 3 of 11



IF/RF MICROWAVE COMPONENTS • ISO 9001 ISO 14001 AS 9100 CERTIFIED • RoHS compliant
P.O. Box 350166, Brooklyn, New York 11235-0003 (718) 934-4500 Fax (718) 332-4661



The Design Engineers Search Engine finds the model you need, Instantly • For detailed performance specs & shopping online see



Typical Performance Data

Definitions:

Input Return Loss = -S11 (dB)

Gain(Power Gain) = S21 (dB)

Reverse Isolation = -S12 (dB)

Output Return Loss = -S22 (dB)

TEST CONDITIONS: Icc = 80mA, Vd = 5.10V @Temperature = -45degC

FREQ	Gain	Isolation	Input Return Loss	Output Return Loss	Stability		FREQ	IP3 Output	1dB Comp. Output	Noise Figure
					K	Delta				
(MHz)	(dB)	(dB)	(dB)	(dB)	K	Delta	(MHz)	(dBm)	(dBm)	(dB)
50	25.17	28.21	26.40	17.01	1.05	0.71	50	37.42	19.92	2.34
100	25.10	28.19	27.39	16.88	1.05	0.71	100	36.85	20.21	2.49
200	24.91	28.05	26.48	15.96	1.05	0.70	150	37.73	20.05	2.37
400	24.34	27.91	22.85	13.71	1.06	0.67	200	36.93	19.97	2.28
600	23.69	27.72	21.98	12.43	1.07	0.64	250	36.87	20.03	2.25
800	22.98	27.52	21.36	11.45	1.08	0.60	300	37.00	20.00	2.53
1000	22.25	27.26	21.08	10.82	1.09	0.56	350	37.83	20.07	2.37
1200	21.48	26.98	20.19	10.29	1.11	0.53	400	36.69	20.03	2.32
1400	20.78	26.61	18.93	9.79	1.11	0.51	450	37.00	20.04	2.28
1600	20.04	26.38	18.29	9.52	1.14	0.48	500	36.08	20.05	2.44
1800	19.40	25.98	17.66	9.22	1.15	0.46	550	36.52	20.00	2.48
2000	18.77	25.66	16.81	9.06	1.16	0.44	600	35.74	19.94	2.36
2200	18.18	25.30	16.30	8.97	1.17	0.42	650	36.13	19.95	2.34
2400	17.63	25.02	15.49	8.95	1.18	0.41	700	35.49	19.86	2.52
2600	17.12	24.66	14.81	8.90	1.18	0.40	750	35.64	19.88	2.53
2800	16.61	24.37	14.35	8.93	1.20	0.38	800	35.14	19.92	2.40
3000	16.16	24.04	13.82	8.94	1.20	0.37	850	35.25	19.88	2.32
3200	15.75	23.76	13.42	9.01	1.21	0.36	900	34.92	19.66	2.42
3400	15.37	23.48	13.18	8.89	1.21	0.36	950	34.82	19.68	2.46
3600	15.01	23.24	12.90	8.92	1.22	0.35	1000	34.52	19.67	2.37
3800	14.66	23.02	12.87	8.98	1.23	0.35	1050	34.22	19.57	2.26
4000	14.38	22.75	12.57	8.95	1.23	0.35	1100	34.14	19.58	2.39
4200	14.02	22.58	12.33	8.91	1.25	0.34	1150	33.73	19.25	2.52
4400	13.72	22.41	12.32	8.81	1.26	0.34	1200	33.67	19.32	2.42
4600	13.44	22.24	12.14	8.72	1.26	0.34	1250	33.34	19.06	2.31
5000	12.93	22.03	12.48	8.41	1.30	0.33	1300	33.17	19.12	2.38
5500	12.28	21.75	12.62	7.79	1.33	0.34	1350	32.83	18.88	2.55
6000	11.49	21.75	11.43	7.09	1.39	0.35	1400	32.75	18.80	2.51
6500	10.41	21.88	9.92	6.43	1.49	0.35	1450	32.57	18.55	2.37
7000	9.14	22.08	8.77	5.93	1.64	0.36	1500	32.38	18.53	2.45
7500	7.60	22.10	8.03	5.50	1.83	0.36	1550	32.27	18.23	2.33
8000	6.01	21.64	7.57	5.14	1.97	0.36	1600	32.45	18.19	2.56
8500	4.35	20.91	6.87	4.90	2.06	0.38	1650	32.19	17.85	2.55
9000	2.73	19.90	6.14	4.61	2.06	0.40	1700	32.57	17.75	2.35
10000	0.11	17.00	5.24	4.43	1.82	0.43	1750	31.58	17.57	2.42
11000	-1.17	13.37	5.43	4.95	1.49	0.41	1800	32.17	17.49	2.48
12000	-1.01	9.26	7.12	6.58	1.24	0.42	1850	30.92	17.28	2.37
13000	-1.13	5.74	7.93	7.45	1.07	0.56	1900	31.74	17.07	2.35
14000	-1.80	3.84	7.35	6.99	1.03	0.68	1950	30.66	16.95	2.42
15000	-4.26	4.99	3.55	3.75	1.04	0.76	2000	31.40	16.78	2.43

REV. X1
GALI-74+
120123
Page 4 of 11



IF/RF MICROWAVE COMPONENTS • ISO 9001 ISO 14001 AS 9100 CERTIFIED • RoHS compliant
P.O. Box 350166, Brooklyn, New York 11235-0003 (718) 934-4500 Fax (718) 332-4661



The Design Engineers Search Engine finds the model you need, Instantly • For detailed performance specs & shopping online see



Typical Performance Data

Definitions:

Input Return Loss = -S11 (dB)

Gain(Power Gain) = S21 (dB)

Reverse Isolation = -S12 (dB)

Output Return Loss = -S22 (dB)

TEST CONDITIONS: Icc = 64mA, Vd = 5.05V @Temperature = -45degC

FREQ	Gain	Isolation	Input Return Loss	Output Return Loss	Stability		FREQ	IP3 Output	1dB Comp. Output	Noise Figure
					K	Delta				
(MHz)	(dB)	(dB)	(dB)	(dB)	K	Delta	(MHz)	(dBm)	(dBm)	(dB)
50	24.96	28.04	31.33	18.52	1.06	0.70	50	34.31	18.57	2.26
100	24.90	27.99	32.28	18.38	1.05	0.70	100	33.75	18.88	2.36
200	24.70	27.83	29.58	17.22	1.05	0.70	150	34.59	18.60	2.30
400	24.15	27.68	24.47	14.50	1.06	0.67	200	33.88	18.65	2.24
600	23.52	27.46	23.05	12.96	1.06	0.64	250	34.04	18.68	2.21
800	22.82	27.29	21.96	11.81	1.07	0.60	300	34.14	18.67	2.42
1000	22.10	27.04	21.28	11.11	1.09	0.56	350	35.03	18.70	2.31
1200	21.34	26.76	20.17	10.55	1.10	0.53	400	34.05	18.71	2.28
1400	20.65	26.40	18.73	9.99	1.11	0.51	450	34.46	18.74	2.24
1600	19.92	26.17	18.05	9.68	1.13	0.48	500	33.76	18.78	2.39
1800	19.27	25.82	17.29	9.36	1.14	0.45	550	34.22	18.67	2.41
2000	18.66	25.46	16.45	9.18	1.15	0.44	600	33.72	18.65	2.30
2200	18.06	25.19	15.94	9.08	1.16	0.42	650	34.09	18.71	2.30
2400	17.52	24.86	15.11	9.04	1.17	0.40	700	33.77	18.68	2.46
2600	17.00	24.54	14.44	9.03	1.18	0.39	750	33.82	18.65	2.47
2800	16.50	24.25	14.04	9.01	1.19	0.38	800	33.63	18.73	2.38
3000	16.04	23.96	13.49	9.07	1.20	0.37	850	33.61	18.62	2.28
3200	15.63	23.65	13.11	9.13	1.20	0.36	900	33.56	18.59	2.36
3400	15.23	23.41	12.86	9.00	1.21	0.35	950	33.42	18.52	2.43
3600	14.89	23.20	12.61	9.04	1.22	0.34	1000	33.31	18.57	2.33
3800	14.54	22.97	12.56	9.11	1.24	0.34	1050	33.00	18.58	2.22
4000	14.24	22.70	12.27	9.09	1.23	0.34	1100	32.98	18.51	2.31
4200	13.89	22.52	12.05	9.07	1.25	0.33	1150	32.65	18.46	2.45
4400	13.60	22.34	12.05	8.97	1.26	0.33	1200	32.64	18.34	2.38
4600	13.30	22.20	11.90	8.89	1.27	0.33	1250	32.40	18.33	2.27
5000	12.79	22.00	12.24	8.59	1.31	0.33	1300	32.21	18.27	2.32
5500	12.12	21.75	12.43	7.98	1.35	0.33	1350	31.93	18.20	2.47
6000	11.34	21.73	11.30	7.31	1.42	0.34	1400	31.81	18.06	2.46
6500	10.25	21.89	9.85	6.66	1.53	0.34	1450	31.68	17.95	2.30
7000	8.99	22.03	8.74	6.15	1.67	0.35	1500	31.52	17.82	2.40
7500	7.47	22.10	8.02	5.69	1.87	0.35	1550	31.42	17.67	2.26
8000	5.87	21.62	7.56	5.31	2.01	0.35	1600	31.57	17.53	2.50
8500	4.22	20.90	6.88	5.04	2.11	0.37	1650	31.45	17.26	2.49
9000	2.62	19.93	6.15	4.74	2.11	0.39	1700	31.74	17.15	2.28
10000	0.04	17.02	5.24	4.53	1.85	0.42	1750	30.86	16.99	2.34
11000	-1.26	13.43	5.42	5.05	1.52	0.40	1800	31.34	16.90	2.41
12000	-1.08	9.31	7.10	6.66	1.25	0.41	1850	30.26	16.72	2.34
13000	-1.20	5.77	7.89	7.50	1.08	0.55	1900	30.94	16.51	2.29
14000	-1.84	3.84	7.32	7.01	1.03	0.68	1950	30.01	16.41	2.36
15000	-4.28	4.98	3.55	3.76	1.04	0.76	2000	30.62	16.25	2.37

REV. X1

GALI-74+

120123

Page 5 of 11



IF/RF MICROWAVE COMPONENTS • ISO 9001 ISO 14001 AS 9100 CERTIFIED • RoHS compliant

P.O. Box 350166, Brooklyn, New York 11235-0003 (718) 934-4500 Fax (718) 332-4661



The Design Engineers Search Engine finds the model you need, Instantly • For detailed performance specs & shopping online see



Typical Performance Data

Definitions:

Input Return Loss = -S11 (dB)

Gain(Power Gain) = S21 (dB)

Reverse Isolation = -S12 (dB)

Output Return Loss = -S22 (dB)

TEST CONDITIONS: Icc = 96mA, Vd = 5.18V @Temperature = -45degC

FREQ	Gain	Isolation	Input Return Loss	Output Return Loss	Stability		FREQ	IP3 Output	1dB Comp. Output	Noise Figure
					K	Delta				
(MHz)	(dB)	(dB)	(dB)	(dB)	K	Delta	(MHz)	(dBm)	(dBm)	(dB)
50	25.31	28.40	24.24	16.00	1.05	0.71	50	39.68	20.37	2.37
100	25.24	28.44	25.04	15.99	1.06	0.70	100	39.16	20.68	2.56
200	25.04	28.28	24.47	15.23	1.05	0.70	150	39.88	20.69	2.42
400	24.46	28.09	21.76	13.23	1.06	0.67	200	39.01	20.63	2.35
600	23.81	27.88	21.14	12.09	1.07	0.64	250	38.72	20.69	2.33
800	23.09	27.67	20.77	11.18	1.08	0.60	300	38.78	20.57	2.55
1000	22.34	27.42	20.76	10.63	1.10	0.56	350	39.41	20.64	2.41
1200	21.58	27.13	20.03	10.15	1.12	0.53	400	38.26	20.64	2.37
1400	20.87	26.79	18.94	9.67	1.12	0.51	450	38.39	20.65	2.33
1600	20.13	26.49	18.36	9.41	1.14	0.48	500	37.35	20.59	2.52
1800	19.48	26.10	17.81	9.14	1.15	0.46	550	37.74	20.55	2.54
2000	18.87	25.78	17.01	8.98	1.16	0.44	600	36.84	20.47	2.40
2200	18.27	25.41	16.51	8.90	1.17	0.43	650	37.19	20.43	2.39
2400	17.73	25.09	15.72	8.86	1.18	0.41	700	36.36	20.31	2.58
2600	17.19	24.71	15.03	8.84	1.19	0.40	750	36.56	20.33	2.57
2800	16.70	24.44	14.61	8.84	1.20	0.39	800	35.92	20.32	2.45
3000	16.24	24.14	14.06	8.87	1.21	0.38	850	36.08	20.34	2.37
3200	15.84	23.81	13.66	8.95	1.21	0.37	900	35.65	20.01	2.50
3400	15.46	23.52	13.41	8.80	1.21	0.36	950	35.56	20.06	2.57
3600	15.11	23.30	13.14	8.84	1.22	0.36	1000	35.21	20.04	2.42
3800	14.76	23.04	13.08	8.88	1.23	0.35	1050	34.91	19.89	2.34
4000	14.48	22.80	12.79	8.86	1.23	0.35	1100	34.79	19.94	2.44
4200	14.14	22.59	12.55	8.80	1.24	0.35	1150	34.37	19.54	2.59
4400	13.83	22.39	12.52	8.70	1.25	0.35	1200	34.32	19.67	2.47
4600	13.55	22.27	12.32	8.59	1.26	0.34	1250	33.95	19.38	2.37
5000	13.05	21.99	12.65	8.27	1.28	0.34	1300	33.79	19.45	2.43
5500	12.40	21.76	12.78	7.64	1.32	0.35	1350	33.43	19.20	2.62
6000	11.63	21.74	11.52	6.93	1.37	0.36	1400	33.35	19.16	2.58
6500	10.55	21.87	9.96	6.28	1.46	0.36	1450	33.17	18.89	2.41
7000	9.27	22.08	8.78	5.78	1.61	0.36	1500	33.00	18.90	2.52
7500	7.75	22.11	8.03	5.37	1.79	0.36	1550	32.85	18.60	2.40
8000	6.12	21.65	7.55	5.02	1.93	0.37	1600	33.05	18.59	2.61
8500	4.43	20.89	6.87	4.80	2.03	0.38	1650	32.77	18.23	2.60
9000	2.83	19.89	6.14	4.52	2.02	0.40	1700	33.15	18.16	2.40
10000	0.20	16.96	5.24	4.36	1.79	0.43	1750	32.10	17.96	2.48
11000	-1.08	13.35	5.44	4.88	1.47	0.41	1800	32.77	17.89	2.54
12000	-0.93	9.24	7.14	6.54	1.23	0.42	1850	31.45	17.69	2.42
13000	-1.08	5.72	7.95	7.43	1.07	0.57	1900	32.34	17.51	2.40
14000	-1.76	3.83	7.36	6.97	1.03	0.68	1950	31.18	17.38	2.51
15000	-4.23	4.98	3.55	3.75	1.04	0.76	2000	32.00	17.20	2.51

REV. X1
GALI-74+
120123
Page 6 of 11



IF/RF MICROWAVE COMPONENTS • ISO 9001 ISO 14001 AS 9100 CERTIFIED • RoHS compliant
P.O. Box 350166, Brooklyn, New York 11235-0003 (718) 934-4500 Fax (718) 332-4661



The Design Engineers Search Engine finds the model you need, Instantly • For detailed performance specs & shopping online see



Typical Performance Data

Definitions:

Input Return Loss = -S11 (dB)

Gain(Power Gain) = S21 (dB)

Reverse Isolation = -S12 (dB)

Output Return Loss = -S22 (dB)

TEST CONDITIONS: Icc = 80mA, Vd = 4.70V @Temperature = +85degC

FREQ	Gain	Isolation	Input Return Loss	Output Return Loss	Stability		FREQ	IP3 Output	1dB Comp. Output	Noise Figure
					K	Delta				
(MHz)	(dB)	(dB)	(dB)	(dB)	K	Delta	(MHz)	(dBm)	(dBm)	(dB)
50	24.88	27.99	27.15	17.75	1.06	0.70	50	36.35	18.96	3.01
100	24.79	27.97	25.89	16.94	1.06	0.70	100	35.79	19.20	3.20
200	24.56	27.91	23.93	15.62	1.06	0.69	150	36.59	19.11	3.10
400	23.98	27.78	23.66	14.32	1.07	0.65	200	35.69	19.09	2.98
600	23.29	27.53	22.61	12.98	1.08	0.62	250	35.30	19.12	3.02
800	22.56	27.32	21.98	12.00	1.09	0.58	300	35.38	19.07	3.16
1000	21.79	27.08	20.97	11.32	1.11	0.54	350	35.99	19.11	3.14
1200	20.99	26.78	20.07	10.75	1.13	0.50	400	34.89	19.08	3.08
1400	20.28	26.47	18.72	10.22	1.14	0.48	450	35.05	19.07	3.08
1600	19.51	26.21	17.86	9.92	1.17	0.45	500	34.13	19.01	3.25
1800	18.82	25.89	16.99	9.62	1.18	0.42	550	34.43	19.01	3.27
2000	18.17	25.53	15.84	9.47	1.19	0.40	600	33.68	18.88	3.11
2200	17.54	25.25	15.26	9.41	1.22	0.38	650	33.90	18.86	3.14
2400	16.97	24.95	14.42	9.41	1.23	0.37	700	33.31	18.75	3.29
2600	16.40	24.58	13.80	9.42	1.24	0.35	750	33.31	18.73	3.33
2800	15.86	24.33	13.40	9.47	1.27	0.34	800	32.86	18.77	3.20
3000	15.37	24.05	12.94	9.50	1.28	0.33	850	32.77	18.69	3.12
3200	14.94	23.78	12.56	9.62	1.29	0.32	900	32.56	18.40	3.25
3400	14.51	23.51	12.34	9.68	1.31	0.31	950	32.27	18.39	3.36
3600	14.15	23.28	12.12	9.80	1.32	0.30	1000	32.07	18.35	3.22
3800	13.77	23.10	12.12	9.92	1.35	0.30	1050	31.61	18.23	3.11
4000	13.44	22.86	12.03	9.91	1.36	0.30	1100	31.56	18.26	3.23
4200	13.08	22.72	11.95	9.88	1.39	0.29	1150	31.04	17.88	3.40
4400	12.73	22.51	12.17	9.75	1.42	0.29	1200	31.05	17.96	3.27
4600	12.43	22.39	12.09	9.57	1.44	0.29	1250	30.63	17.63	3.17
5000	11.81	22.27	11.98	9.23	1.50	0.29	1300	30.47	17.72	3.23
5500	10.94	22.16	11.46	8.93	1.60	0.28	1350	30.04	17.47	3.41
6000	10.02	22.22	11.07	8.49	1.74	0.27	1400	30.00	17.36	3.40
6500	8.89	22.32	10.47	8.09	1.94	0.27	1450	29.67	17.10	3.24
7000	7.55	22.45	9.69	7.49	2.20	0.28	1500	29.63	17.05	3.36
7500	5.92	22.46	8.64	6.82	2.47	0.29	1550	29.30	16.79	3.21
8000	4.26	21.94	7.98	6.22	2.65	0.30	1600	29.64	16.74	3.47
8500	2.55	21.21	7.22	5.70	2.75	0.32	1650	29.25	16.40	3.44
9000	0.99	20.17	6.52	5.41	2.74	0.33	1700	29.72	16.28	3.23
10000	-1.22	16.84	5.94	5.50	2.32	0.34	1750	28.63	16.07	3.30
11000	-2.18	13.11	6.35	6.25	1.86	0.33	1800	29.23	15.98	3.39
12000	-2.44	9.51	7.48	7.36	1.51	0.36	1850	28.00	15.81	3.36
13000	-2.26	5.92	9.84	9.28	1.27	0.46	1900	28.72	15.57	3.28
14000	-3.19	4.65	6.80	6.68	1.16	0.60	1950	27.76	15.49	3.36
15000	-5.16	5.69	4.16	4.17	1.16	0.66	2000	28.29	15.24	3.35

REV. X1
GALI-74+
120123
Page 7 of 11



IF/RF MICROWAVE COMPONENTS • ISO 9001 ISO 14001 AS 9100 CERTIFIED • RoHS compliant
P.O. Box 350166, Brooklyn, New York 11235-0003 (718) 934-4500 Fax (718) 332-4661



The Design Engineers Search Engine finds the model you need, Instantly • For detailed performance specs & shopping online see



Typical Performance Data

Definitions:

Input Return Loss = -S11 (dB)

Gain(Power Gain) = S21 (dB)

Reverse Isolation = -S12 (dB)

Output Return Loss = -S22 (dB)

TEST CONDITIONS: Icc = 64mA, Vd = 4.64V @Temperature = +85degC

FREQ	Gain	Isolation	Input Return Loss	Output Return Loss	Stability		FREQ	IP3 Output	1dB Comp. Output	Noise Figure
					K	Delta				
(MHz)	(dB)	(dB)	(dB)	(dB)	K	Delta	(MHz)	(dBm)	(dBm)	(dB)
50	24.62	27.69	34.54	20.07	1.06	0.70	50	33.56	18.06	2.93
100	24.52	27.73	31.53	18.85	1.06	0.69	100	33.04	18.32	3.10
200	24.31	27.57	27.32	17.08	1.06	0.69	150	33.93	18.11	3.04
400	23.75	27.41	25.28	15.23	1.06	0.66	200	33.16	18.12	2.95
600	23.09	27.26	23.35	13.58	1.07	0.61	250	32.98	18.10	2.96
800	22.37	27.03	22.01	12.43	1.08	0.58	300	33.09	18.10	3.08
1000	21.61	26.78	20.65	11.63	1.10	0.54	350	33.74	18.10	3.10
1200	20.82	26.58	19.62	11.00	1.12	0.50	400	32.78	18.08	3.02
1400	20.11	26.24	18.18	10.42	1.13	0.47	450	33.01	18.12	3.00
1600	19.36	25.94	17.37	10.08	1.15	0.44	500	32.31	18.09	3.15
1800	18.69	25.66	16.48	9.75	1.17	0.42	550	32.64	18.02	3.18
2000	18.03	25.32	15.38	9.57	1.18	0.40	600	32.10	17.95	3.07
2200	17.40	25.07	14.81	9.51	1.21	0.38	650	32.35	18.02	3.09
2400	16.82	24.75	14.01	9.53	1.22	0.36	700	31.97	17.96	3.20
2600	16.27	24.45	13.41	9.53	1.23	0.35	750	31.92	17.93	3.25
2800	15.74	24.20	13.01	9.56	1.26	0.33	800	31.68	18.03	3.16
3000	15.25	23.92	12.58	9.59	1.27	0.32	850	31.55	17.91	3.07
3200	14.81	23.66	12.20	9.73	1.29	0.31	900	31.50	17.75	3.18
3400	14.39	23.39	11.99	9.79	1.30	0.30	950	31.22	17.73	3.20
3600	14.01	23.21	11.81	9.93	1.33	0.29	1000	31.10	17.70	3.14
3800	13.64	23.02	11.80	10.07	1.35	0.29	1050	30.67	17.66	3.03
4000	13.31	22.81	11.72	10.06	1.37	0.29	1100	30.64	17.61	3.13
4200	12.95	22.63	11.68	10.03	1.39	0.28	1150	30.21	17.36	3.32
4400	12.60	22.46	11.89	9.92	1.42	0.28	1200	30.18	17.34	3.22
4600	12.30	22.38	11.82	9.76	1.45	0.28	1250	29.83	17.14	3.10
5000	11.65	22.22	11.77	9.44	1.51	0.28	1300	29.68	17.14	3.13
5500	10.79	22.12	11.29	9.17	1.62	0.27	1350	29.29	16.94	3.34
6000	9.87	22.22	10.96	8.74	1.77	0.26	1400	29.23	16.80	3.32
6500	8.75	22.29	10.41	8.34	1.98	0.26	1450	28.93	16.57	3.19
7000	7.41	22.42	9.67	7.72	2.24	0.27	1500	28.88	16.50	3.26
7500	5.79	22.44	8.65	7.02	2.52	0.28	1550	28.60	16.28	3.13
8000	4.13	21.93	7.99	6.40	2.71	0.29	1600	28.90	16.16	3.39
8500	2.45	21.21	7.23	5.85	2.81	0.31	1650	28.58	15.86	3.37
9000	0.91	20.17	6.54	5.53	2.78	0.33	1700	29.01	15.73	3.14
10000	-1.29	16.88	5.94	5.61	2.36	0.34	1750	27.98	15.53	3.20
11000	-2.26	13.16	6.34	6.33	1.88	0.32	1800	28.52	15.44	3.31
12000	-2.52	9.55	7.44	7.44	1.53	0.35	1850	27.38	15.28	3.29
13000	-2.32	5.94	9.80	9.31	1.27	0.45	1900	28.03	15.05	3.20
14000	-3.23	4.65	6.78	6.69	1.16	0.60	1950	27.14	14.94	3.25
15000	-5.18	5.68	4.16	4.17	1.16	0.66	2000	27.62	14.69	3.24

REV. X1
GALI-74+
120123
Page 8 of 11



IF/RF MICROWAVE COMPONENTS • ISO 9001 ISO 14001 AS 9100 CERTIFIED • RoHS compliant
P.O. Box 350166, Brooklyn, New York 11235-0003 (718) 934-4500 Fax (718) 332-4661



The Design Engineers Search Engine finds the model you need, Instantly • For detailed performance specs & shopping online see



Typical Performance Data

Definitions:

Input Return Loss = -S11 (dB)

Gain(Power Gain) = S21 (dB)

Reverse Isolation = -S12 (dB)

Output Return Loss = -S22 (dB)

TEST CONDITIONS: Icc = 96mA, Vd = 4.77V @Temperature = +85degC

FREQ	Gain	Isolation	Input Return Loss	Output Return Loss	Stability		FREQ	IP3 Output	1dB Comp. Output	Noise Figure
					K	Delta				
(MHz)	(dB)	(dB)	(dB)	(dB)	K	Delta	(MHz)	(dBm)	(dBm)	(dB)
50	25.03	28.17	24.22	16.57	1.06	0.71	50	38.28	19.16	3.07
100	24.94	28.20	23.50	15.88	1.06	0.70	100	37.66	19.37	3.28
200	24.71	28.11	22.07	14.74	1.06	0.69	150	38.21	19.35	3.17
400	24.13	27.96	22.32	13.72	1.07	0.65	200	37.27	19.41	3.03
600	23.42	27.76	21.82	12.58	1.08	0.61	250	36.70	19.51	3.10
800	22.69	27.53	21.60	11.74	1.10	0.57	300	36.72	19.50	3.25
1000	21.90	27.26	20.91	11.12	1.12	0.54	350	37.15	19.55	3.22
1200	21.11	26.98	20.17	10.59	1.14	0.50	400	36.08	19.50	3.15
1400	20.37	26.61	18.96	10.10	1.15	0.48	450	36.09	19.50	3.14
1600	19.61	26.34	18.11	9.81	1.17	0.45	500	35.12	19.36	3.34
1800	18.91	25.99	17.27	9.53	1.19	0.43	550	35.36	19.36	3.34
2000	18.26	25.64	16.10	9.38	1.20	0.41	600	34.54	19.23	3.18
2200	17.63	25.36	15.56	9.34	1.22	0.39	650	34.71	19.19	3.20
2400	17.05	25.03	14.70	9.33	1.24	0.37	700	34.00	19.05	3.37
2600	16.50	24.67	14.06	9.36	1.25	0.36	750	34.00	19.04	3.39
2800	15.98	24.41	13.66	9.39	1.27	0.35	800	33.47	19.04	3.27
3000	15.47	24.13	13.17	9.43	1.28	0.33	850	33.41	19.03	3.22
3200	15.05	23.84	12.80	9.54	1.29	0.32	900	33.13	18.68	3.36
3400	14.62	23.55	12.56	9.60	1.31	0.32	950	32.85	18.66	3.40
3600	14.25	23.33	12.33	9.73	1.32	0.31	1000	32.61	18.66	3.27
3800	13.86	23.13	12.32	9.83	1.35	0.30	1050	32.15	18.51	3.17
4000	13.55	22.89	12.24	9.82	1.36	0.30	1100	32.10	18.56	3.30
4200	13.20	22.68	12.18	9.77	1.38	0.30	1150	31.58	18.15	3.47
4400	12.85	22.56	12.37	9.64	1.41	0.30	1200	31.56	18.26	3.36
4600	12.55	22.43	12.27	9.45	1.43	0.30	1250	31.14	17.92	3.24
5000	11.91	22.26	12.12	9.10	1.48	0.29	1300	30.99	18.03	3.33
5500	11.06	22.16	11.56	8.77	1.58	0.29	1350	30.54	17.76	3.51
6000	10.15	22.24	11.12	8.34	1.72	0.28	1400	30.51	17.73	3.47
6500	9.02	22.34	10.51	7.93	1.92	0.28	1450	30.18	17.42	3.32
7000	7.65	22.47	9.69	7.33	2.17	0.28	1500	30.13	17.42	3.42
7500	6.02	22.49	8.63	6.68	2.44	0.29	1550	29.80	17.13	3.32
8000	4.35	21.95	7.96	6.11	2.61	0.30	1600	30.16	17.11	3.55
8500	2.64	21.21	7.20	5.60	2.71	0.32	1650	29.72	16.78	3.51
9000	1.07	20.18	6.51	5.32	2.70	0.34	1700	30.22	16.71	3.32
10000	-1.16	16.80	5.93	5.43	2.29	0.35	1750	29.11	16.46	3.40
11000	-2.11	13.09	6.36	6.19	1.84	0.33	1800	29.73	16.43	3.49
12000	-2.38	9.48	7.48	7.32	1.50	0.36	1850	28.48	16.26	3.42
13000	-2.21	5.90	9.87	9.26	1.26	0.46	1900	29.25	16.02	3.39
14000	-3.15	4.65	6.80	6.67	1.16	0.61	1950	28.25	15.93	3.45
15000	-5.13	5.69	4.15	4.17	1.15	0.66	2000	28.81	15.67	3.44

REV. X1
GALI-74+
120123
Page 9 of 11



IF/RF MICROWAVE COMPONENTS • ISO 9001 ISO 14001 AS 9100 CERTIFIED • RoHS compliant
P.O. Box 350166, Brooklyn, New York 11235-0003 (718) 934-4500 Fax (718) 332-4661



The Design Engineers Search Engine finds the model you need, Instantly • For detailed performance specs & shopping online see



Typical Performance Curves

GAIN vs. TEMPERATURE

INPUT POWER = -20dBm, CURRENT = 80mA

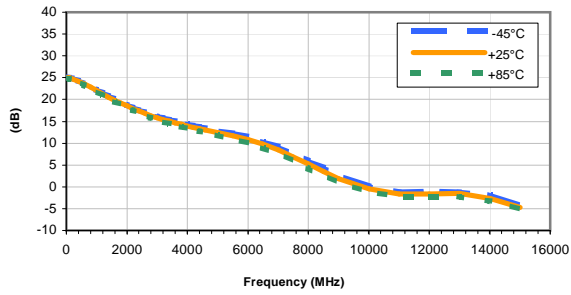

GAIN vs. CURRENT

INPUT POWER = -20dBm, Temperature = +25°C

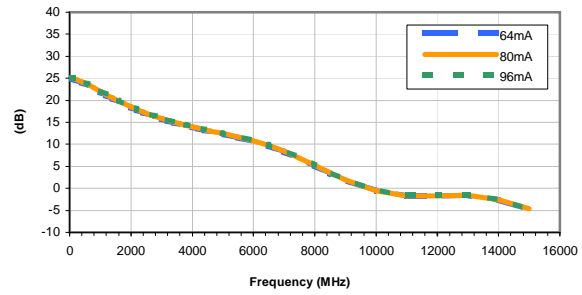

ISOLATION vs. TEMPERATURE

INPUT POWER = -20dBm, CURRENT = 80mA

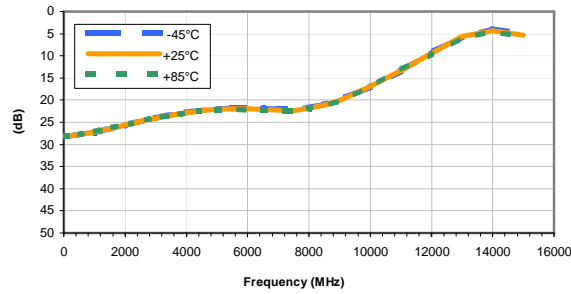

ISOLATION vs. CURRENT

INPUT POWER = -20dBm, Temperature = +25°C

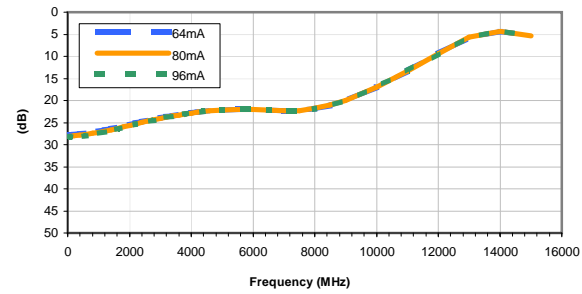

INPUT RETURN LOSS vs. TEMPERATURE

INPUT POWER = -20dBm, CURRENT = 80mA

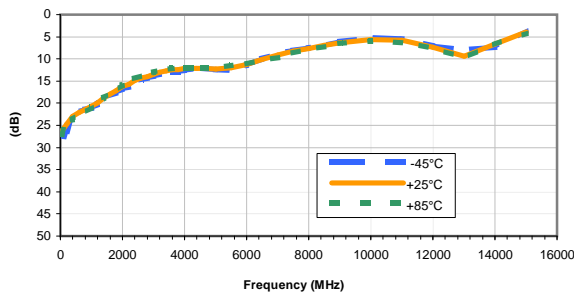

INPUT RETURN LOSS vs. CURRENT

INPUT POWER = -20dBm, Temperature = +25°C

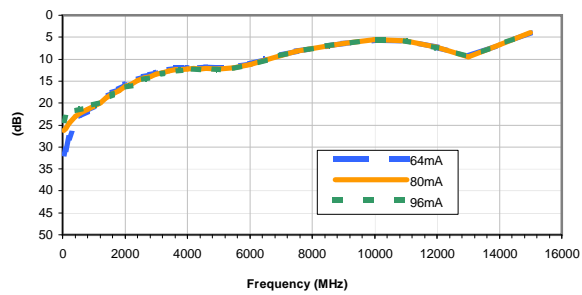

OUTPUT RETURN LOSS vs. TEMPERATURE

INPUT POWER = -20dBm, CURRENT = 80mA

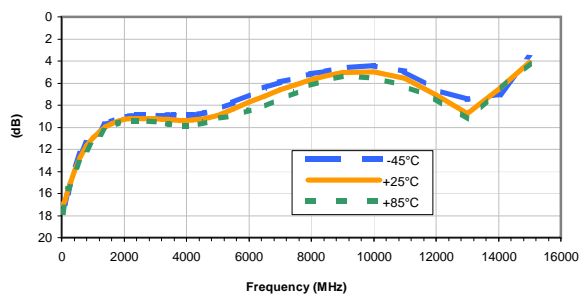

OUTPUT RETURN LOSS vs. CURRENT

INPUT POWER = -20dBm, Temperature = +25°C

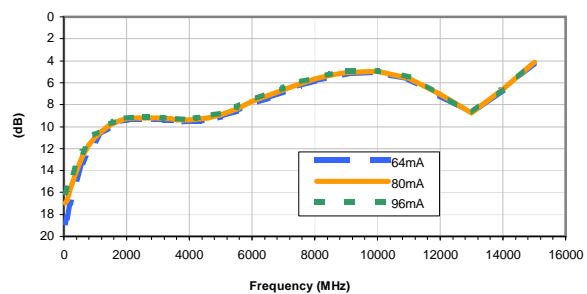

IF/RF MICROWAVE COMPONENTS • ISO 9001 ISO 14001 AS 9100 CERTIFIED • RoHS compliant
P.O. Box 350166, Brooklyn, New York 11235-0003 (718) 934-4500 Fax (718) 332-4661



The Design Engineers Search Engine finds the model you need, Instantly • For detailed performance specs & shopping online see minicircuits.com

Typical Performance Curves

OUTPUT IP3 vs. TEMPERATURE

INPUT POWER = -20dBm, CURRENT = 80mA

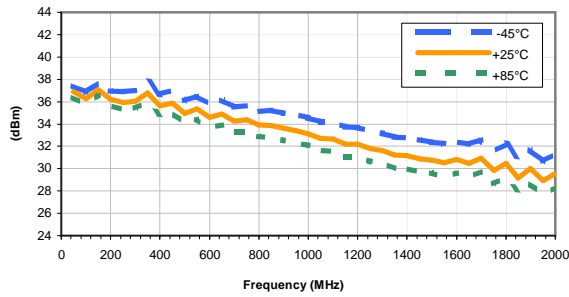

OUTPUT IP3 vs. CURRENT

INPUT POWER = -20dBm, Temperature = +25°C

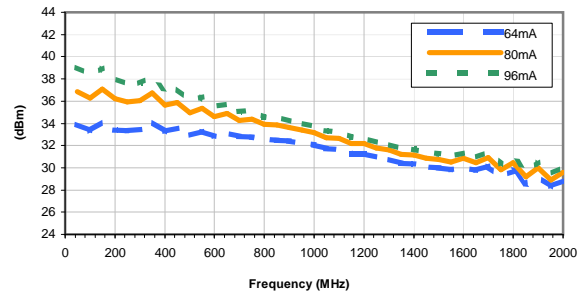

OUTPUT POWER at 1dB Compression vs. TEMPERATURE

CURRENT = 80mA

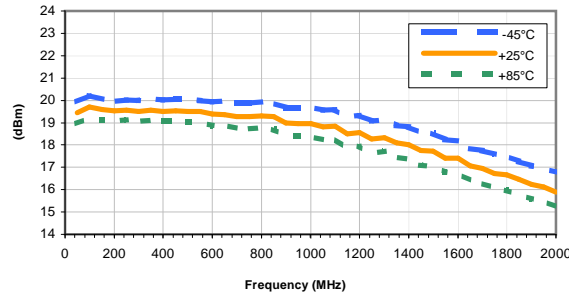

OUTPUT POWER at 1dB Compression vs. CURRENT

Temperature = +25°C

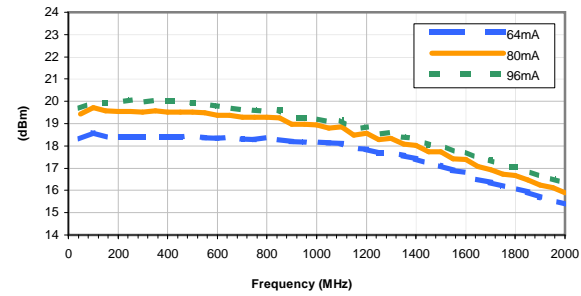

Noise Figure vs. TEMPERATURE

CURRENT = 80mA

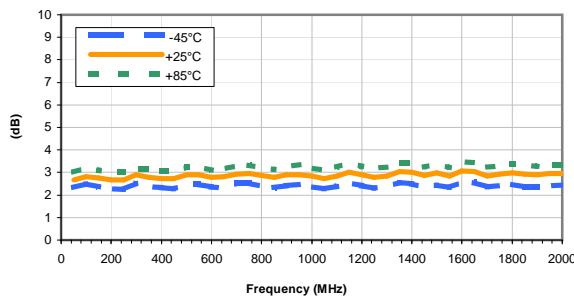

Noise Figure vs. CURRENT

Temperature = +25°C

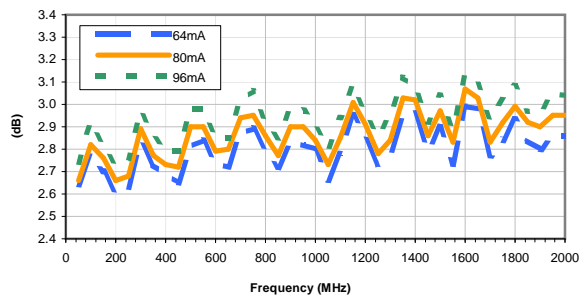

Typical Performance Curves

GAIN vs. TEMPERATURE

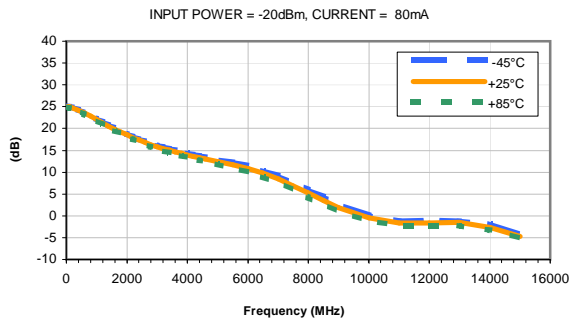

GAIN vs. CURRENT

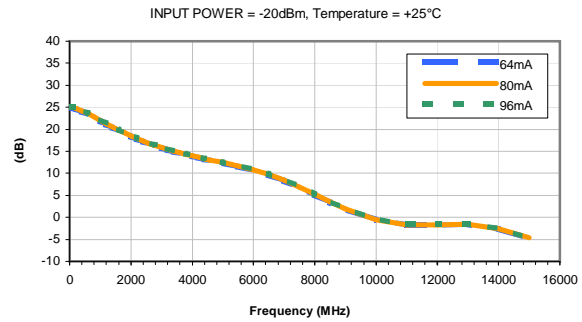

ISOLATION vs. TEMPERATURE

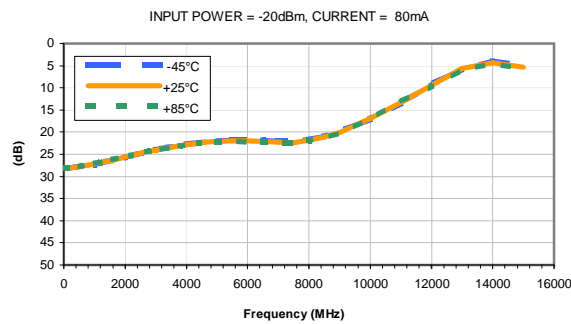

ISOLATION vs. CURRENT

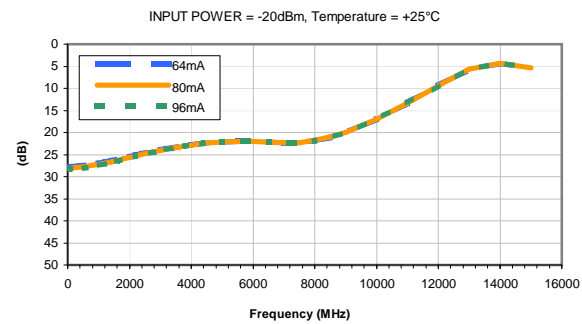

INPUT RETURN LOSS vs. TEMPERATURE

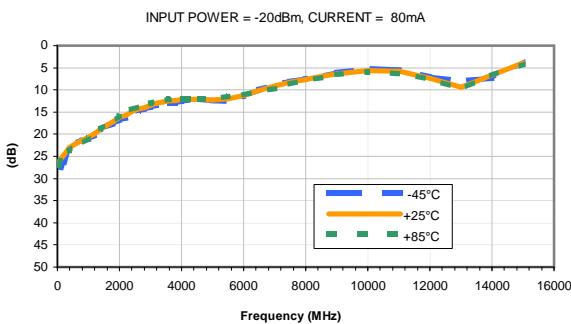

INPUT RETURN LOSS vs. CURRENT

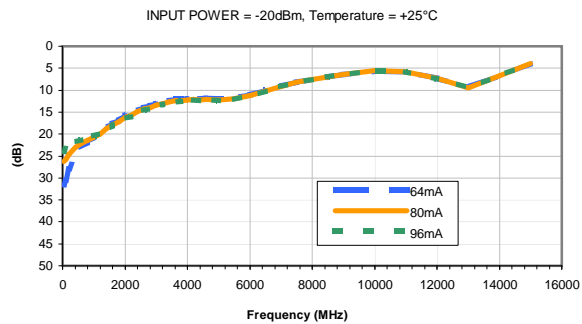

OUTPUT RETURN LOSS vs. TEMPERATURE

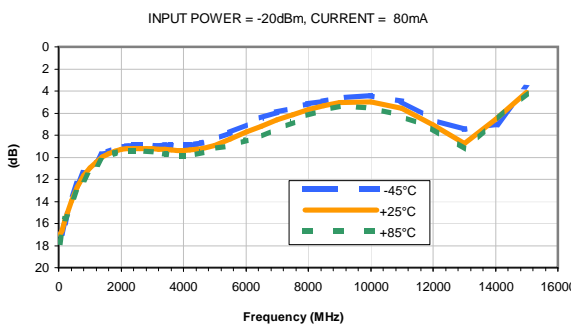

OUTPUT RETURN LOSS vs. CURRENT

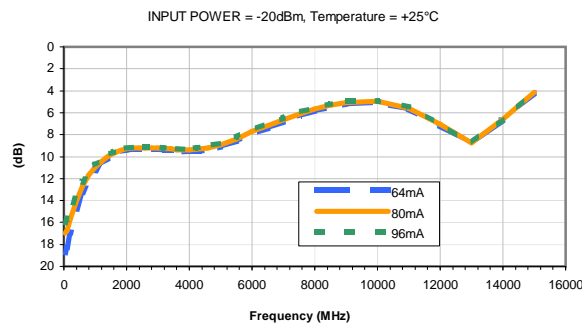

Typical Performance Curves

OUTPUT IP3 vs. TEMPERATURE

INPUT POWER = -20dBm, CURRENT = 80mA

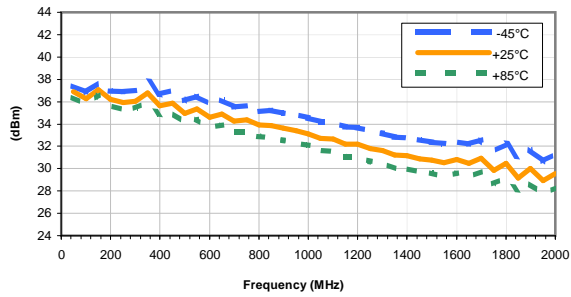

OUTPUT IP3 vs. CURRENT

INPUT POWER = -20dBm, Temperature = +25°C

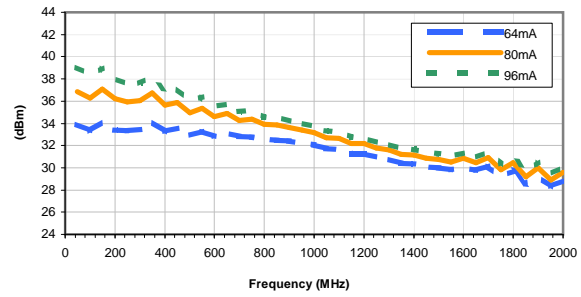

OUTPUT POWER at 1dB Compression vs. TEMPERATURE

CURRENT = 80mA

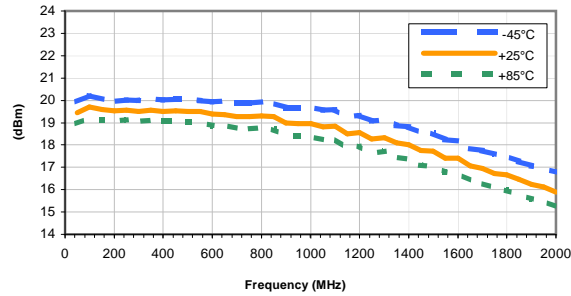

OUTPUT POWER at 1dB Compression vs. CURRENT

Temperature = +25°C

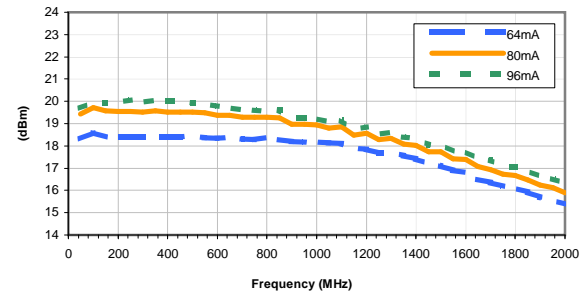

Noise Figure vs. TEMPERATURE

CURRENT = 80mA

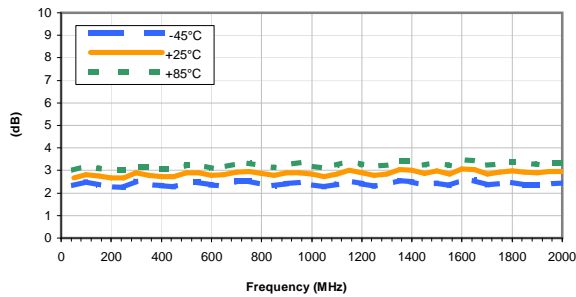

Noise Figure vs. CURRENT

Temperature = +25°C

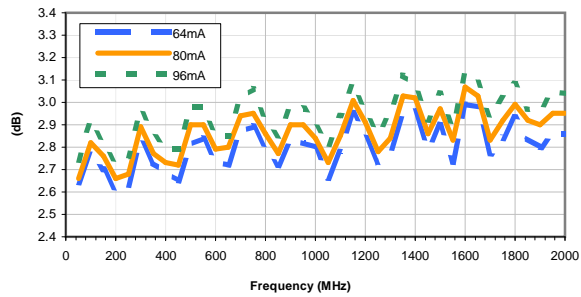

Outline Dimensions



PCB Land Pattern



Suggested Layout,
Tolerance to be within $\pm .002$

CASE #	A	B	C	D	E	F	G	H	J	K	L	M
DF782	.102 (2.59)	.090 (2.29)	.181 (4.60)	.173 (4.39)	.063 (1.60)	.167 (4.24)	.155 (3.94)	.059 (1.50)	.118 (3.00)	.015 (0.38)	.041 (1.04)	.016 (0.41)

CASE #	N	P	Q	WT. GRAM
DF782	.019 (0.48)	.065 (1.65)	.062 (1.57)	.2

Dimensions are in inches (mm). Tolerances: 2 Pl. $\pm .01$; 3Pl. $\pm .005$

Notes:

- Case material: Plastic.
- Termination finish:
For RoHS Case Styles: Tin-Silver alloy plate over Nickel barrier or Matte-Tin.
All models, (+) suffix. See model Data sheet.
For RoHS-5 Case Styles: Tin-Lead plate. All models, no (+) suffix.



INTERNET <http://www.minicircuits.com>

P.O. Box 350166, Brooklyn, New York 11235-0003 (718) 934-4500 Fax (718) 332-4661

Distribution Centers NORTH AMERICA 800-654-7949 • 417-335-5935 • Fax 417-335-5945 • EUROPE 44-1252-832600 • Fax 44-1252-837010

Mini-Circuits ISO 9001 & ISO 14001 Certified

Tape & Reel Packaging TR-F55

DEVICE ORIENTATION IN T&R

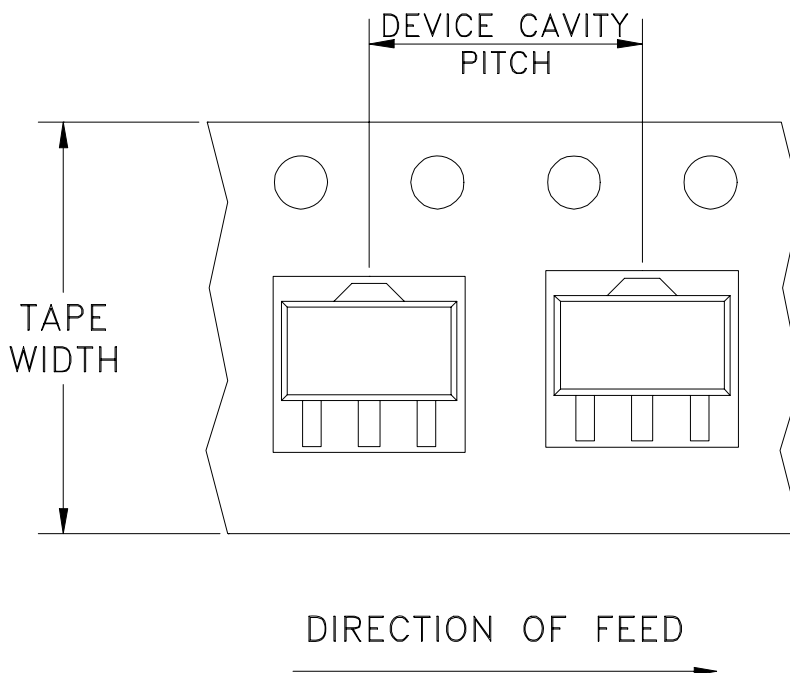

Tape Width, mm	Device Cavity Pitch, mm	Reel Size, inches	Devices per Reel	
12	8	7	Small quantity standard (see note)	20
				50
				100
				200
				500
			Standard	1000

Note: Please consult individual model data sheet to determine device per reel availability.

Mini-Circuits carrier tape materials provide protection from ESD (Electro-Static Discharge) during handling and transportation. Tapes are static dissipative and comply with industry standards EIA-481/EIA-541.

Go to: www.minicircuits.com/pages/pdfs/tape.pdf



INTERNET <http://www.minicircuits.com>

P.O. Box 350166, Brooklyn, New York 11235-0003 (718) 934-4500 Fax (718) 332-4661

Distribution Centers NORTH AMERICA 800-654-7949 • 417-335-5935 • Fax 417-335-5945 • EUROPE 44-1252-832600 • Fax 44-1252-837010

Mini-Circuits ISO 9001 & ISO 14001 Certified

THIRD ANGLE PROJECTION



REVISIONS

REV	ECN No.	DESCRIPTION	DATE	DR	AUTH
A	M76190	CHANGED DISCRIPTION	04/01	GF	CT
B	M82575	UPDATED DRAWING	08/05/02	AV	LC
C	M102713	ADDED NOTE 2 & "...WITH SMOBC"	01/17/06	MMG	IL
D	M108434	UPDATED DRAWING PER TB-409+	11/14/06	PW	IG

SUGGESTED MOUNTING CONFIGURATION
FOR DF782 CASE STYLE, "mz" PIN CONNECTION



- NOTES:** 1. TRACE WIDTH IS SHOWN FOR ROGERS R04350B WITH DIELECTRIC THICKNESS .030" ± .002"; COPPER: 1/2 OZ. EACH SIDE. FOR OTHER MATERIALS TRACE WIDTH MAY NEED TO BE MODIFIED.
2. BOTTOM SIDE OF THE PCB IS CONTINUOUS GROUND PLANE.



DENOTES PCB COPPER LAYOUT WITH SMOBC (SOLDER MASK OVER BARE COPPER)



DENOTES COPPER LAND PATTERN FREE OF SOLDER MASK

UNLESS OTHERWISE SPECIFIED	INITIALS	DATE
DIMENSIONS ARE IN INCHES TOLERANCES ON: 2 PL DECIMALS ± 3 PL DECIMALS ± .005 ANGLES ± FRACTIONS ±	DRAWN	AV 01/15/01
	CHECKED	YB 01/23/01
	APPROVED	DB 01/23/01



Mini-Circuits® 13 Neptune Avenue
Brooklyn NY 11235

PL, mz, DF782, GALI, TB-409-XXX+

Mini-Circuits®
THIS DOCUMENT AND ITS CONTENTS ARE THE PROPERTY OF MINI-CIRCUITS. EXCEPT FOR USE EXPRESSLY GRANTED, IN WRITING, TO ITS VENDORS, VENDEE AND THE UNITED STATES GOVERNMENT, MINI-CIRCUITS RESERVES ALL PROPRIETARY DESIGN, USE, MANUFACTURING AND REPRODUCTION RIGHTS THERETO. THESE CONTENTS SHALL NOT BE USED, DUPLICATED OR DISCLOSED TO ANY OUTSIDE PARTY, IN WHOLE OR IN PART, WITHOUT WRITTEN PERMISSION OF MINI-CIRCUITS.

SIZE	CODE IDENT	DRAWING NO:	REV:
A	15542	98-PL-019	D
FILE:	98PL019	SCALE:	10:1
		SHEET:	1 OF 1

Evaluation Board and Circuit

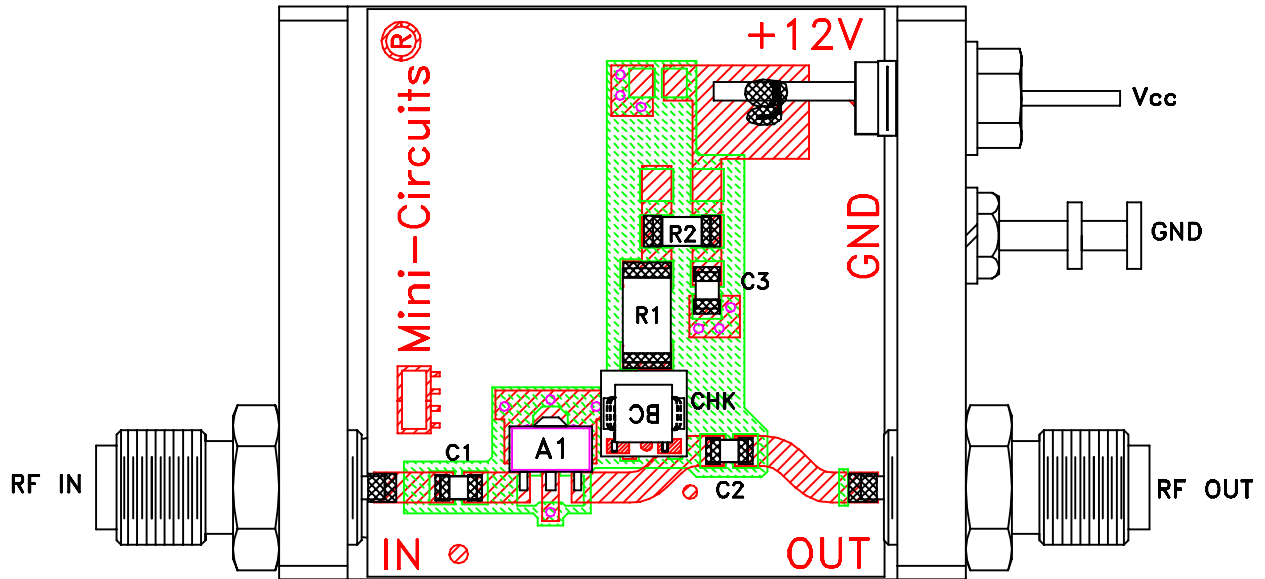

TB-409-74+

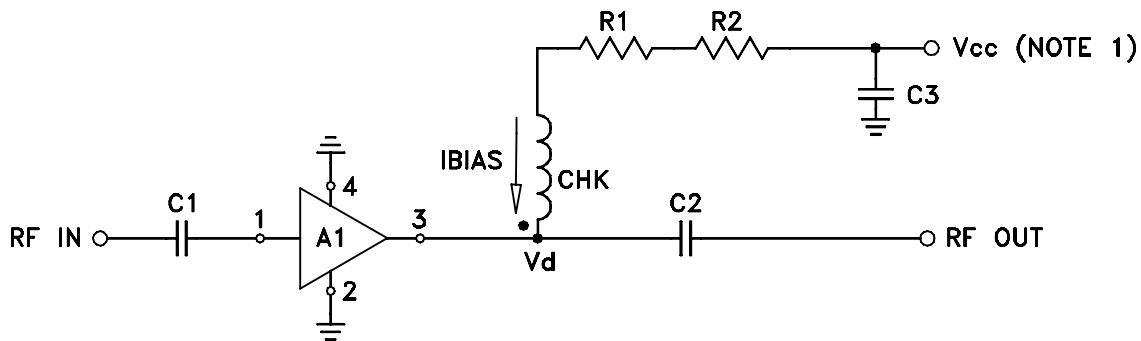

COMPONENT	VALUE
A1	Gali-74(+)
C1 (NOTE 4)	2400 pF
C2 (NOTE 4)	2400 pF
C3 (bypass)	0.1 uF
R1	68.1 Ohms, 0.75W
R2	22.1 Ohms, 0.25W
CHK	Mini-Circuits TCCH-80+

Schematic Diagram

NOTE:

1. Vcc voltage: $+12 \pm 0.2V$.
2. SMA Female connectors.
3. PCB material: Rogers RO4350 or equivalent, dielectric constant=3.5, dielectric thickness=.030 inch.
4. Capacitors, C1 & C2 should be free of resonance up to the highest frequency specified.

 **Mini-Circuits®**

All Mini-Circuits products are manufactured under exacting quality assurance and control standards, and are capable of meeting published specifications after being subjected to any or all of the following physical and environmental test.

Specification	Test/Inspection Condition	Reference/Spec
Operating Temperature	-45° to 85°C or -40° to 85°C Ambient Environment	Individual Model Data Sheet
Storage Temperature	-65° to 150° C Ambient Environment	Individual Model Data Sheet
Thermal Shock	-55° to 100°C, 100 cycles	MIL-STD-202, Method 107, Condition A-3, except +100°C
Mechanical Shock	1.5Kg, 0.5 ms, 5 shock pulses, Y1 direction only	MIL-STD-883, Method 2002, Condition B, except Y1 direction only
Vibration (Variable Frequency)	50g peak	MIL-STD-883, Method 2007, Condition B
Autoclave	15 psig, 100% RH, 121°C, 96 hours	JESD22-A102, Condition C
HAST	130°C, 85% RH, 96 hours	JESD22-A110
Solderability	10X Magnification	J-STD-002, Para 4.2.5, Test S, 95% Coverage
Solder Reflow Heat	Sn-Pb Eutetic Process: 240°C peak Pb-Free Process: 260°C peak	J-STD-020, Table 4-1, 4-2 and 5-2; Figure 5-1
Moisture Sensitivity: Level 1	Bake at 125°C for 24 hours Soak at 85°C/85% RH for 168 hours, Reflow 3 cycles at 260°C peak	J-STD-020
Marking Resistance to Solvents	Isopropyl alcohol + mineral spirits at 25°C; terpene defluxer at 25°C; distilled water + proylene glycol monomethyl ether +	MIL-STD-202, Method 215



All Mini-Circuits products are manufactured under exacting quality assurance and control standards, and are capable of meeting published specifications after being subjected to any or all of the following physical and environmental test.

Specification	Test/Inspection Condition	Reference/Spec
	monoethanolamine at 63°C to 70°C	