

Ceramic

Frequency Mixer WIDE BAND

MCA1-24MH+

Level 13 (LO Power+13 dBm) 300 to 2400 MHz

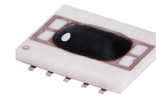

Generic photo used for illustration purposes only

CASE STYLE: DZ885

Maximum Ratings

Operating Temperature	-55°C to 100°C
Storage Temperature	-55°C to 100°C
RF Power	200 mW
IF Current	40 mA
Permanent damage may occur if any of these limits are exceeded.	

Pin Connections

LO	10
RF	5
IF	3
GROUND	1,2,4,6,7,8,9

Features

- wide bandwidth, 300 to 2400 MHz
- low conversion loss, 6.1 dB typ.
- excellent L-R isolation, 40 dB typ.
- LTCC double balanced mixer
- aqueous washable
- low cost
- low profile, 0.08"
- protected by US Patent 7,027,795

Recommended Replacement:

MAC-24MH+

- Footprint Compatible
- MIL Level Reliability

[Click here for data sheet](#)

+RoHS Compliant

The +Suffix identifies RoHS Compliance. See our web site for RoHS Compliance methodologies and qualifications

Available Tape and Reel at no extra cost	
Reel Size	Devices/Reel
7"	10, 20, 50, 100, 200
13"	500, 1000

Outline Drawing

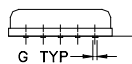
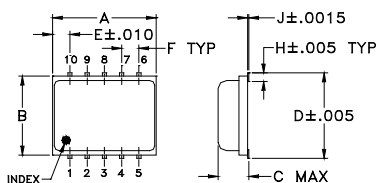

PCB Land Pattern

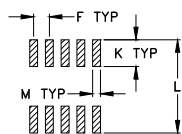

Suggested Layout, Tolerance to be within ±.002

Outline Dimensions (inch/mm)

A	B	C	D	E	F	G
.30	.250	.085	.266	.050	.050	.012
7.62	6.35	2.16	6.76	1.27	1.27	0.30
H	J	K	L	M		wt
.029	.004	.085	.296	.030		grams
0.74	0.10	2.16	7.52	0.76		0.25

Demo Board MCL P/N: TB-144 Suggested PCB Layout (PL-045)

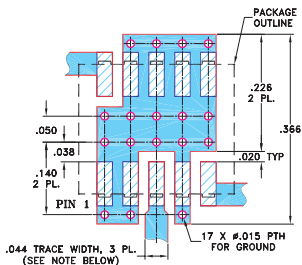

NOTES: 1. TRACE WIDTH IS SHOWN FOR ROGERS RO4350B WITH DIELECTRIC THICKNESS .020" ± .0015"; COPPER: 1/2 OZ. EACH SIDE. FOR OTHER MATERIALS TRACE WIDTH MAY NEED TO BE MODIFIED.
2. BOTTOM SIDE OF THE PCB IS CONTINUOUS GROUND PLANE.

- DENOTES PCB COPPER LAYOUT WITH SMOBC (SOLDER MASK OVER BARE COPPER)
- DENOTES COPPER LAND PATTERN FREE OF SOLDER MASK

Notes

- Performance and quality attributes and conditions not expressly stated in this specification document are intended to be excluded and do not form a part of this specification document.
- Electrical specifications and performance data contained in this specification document are based on Mini-Circuit's applicable established test performance criteria and measurement instructions.
- The parts covered by this specification document are subject to Mini-Circuits standard limited warranty and terms and conditions (collectively, "Standard Terms"); Purchasers of this part are entitled to the rights and benefits contained therein. For a full statement of the Standard Terms and the exclusive rights and remedies thereunder, please visit Mini-Circuits' website at www.minicircuits.com/MCLStore/terms.jsp

Applications

- cellular
- PCN
- defense & weather radar
- UHF TV
- WCDMA
- defense communications

Electrical Specifications (T_{AMB}=-55°C to 100°C)

FREQUENCY (MHz)	CONVERSION LOSS (dB)	LO-RF ISOLATION (dB)		LO-IF ISOLATION (dB)		IP3 at center band (dBm)			
		Typ.	Min.	Typ.	Min.				
LO/RF f _L -f _U	IF	\bar{X}	σ	Max.					
300-2400	DC-700	6.1	0.1	8.9	40	20	25	14	13

1 dB COMPR. +9 dBm typ.

Typical Performance Data

Frequency (MHz)	Conversion Loss (dB)	Isolation L-R (dB)	Isolation L-I (dB)	VSWR RF Port (:1)	VSWR LO Port (:1)	
						LO +13dBm
RF	LO	+13dBm	+13dBm	+13dBm	+13dBm	
300.00	330.00	5.82	49.37	21.78	1.81	8.01
400.00	430.00	5.10	42.20	23.99	1.56	2.46
500.00	530.00	6.84	40.15	27.27	3.96	1.34
700.00	730.00	6.58	46.19	27.35	3.69	2.12
1000.00	1030.00	7.41	43.92	24.46	4.01	2.74
1200.00	1230.00	7.45	39.35	31.83	4.28	3.82
1500.00	1530.00	5.74	39.15	28.78	1.91	2.66
1700.00	1730.00	5.13	36.63	25.65	1.04	1.79
2000.00	2030.00	6.17	32.38	21.69	2.26	2.44
2200.00	2230.00	7.25	33.19	20.62	3.48	3.62
2400.00	2430.00	7.16	30.70	25.44	3.42	7.44

Electrical Schematic

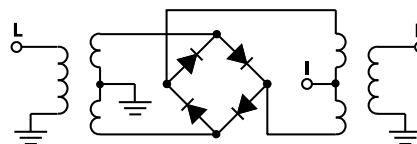

Mini-Circuits

www.minicircuits.com P.O. Box 350166, Brooklyn, NY 11235-0003 (718) 934-4500 sales@minicircuits.com

REV. F
M151107
ED-9574/9
MCA1-24MH+
DJ/RS/CP/AM
200512
Page 1 of 2

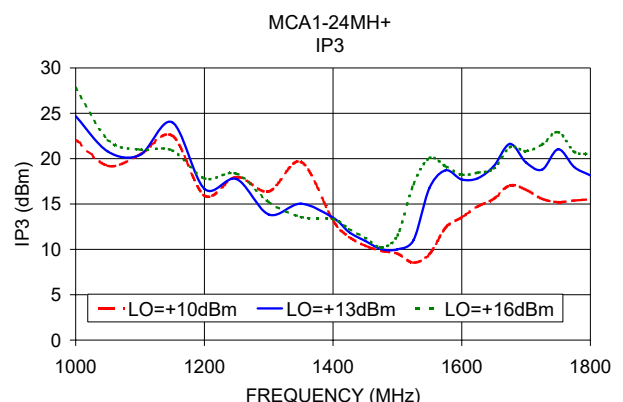
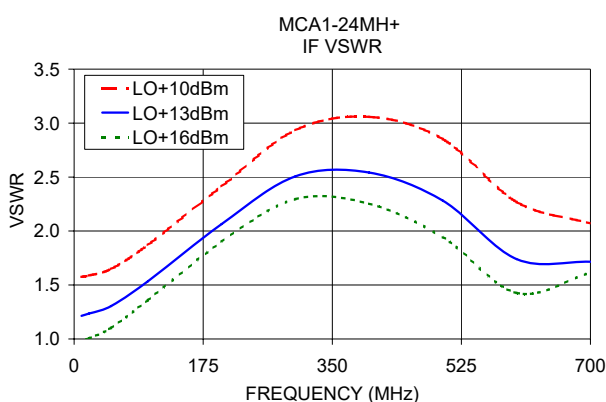
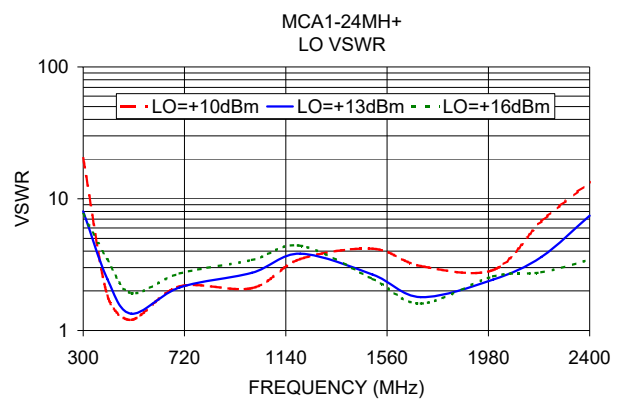
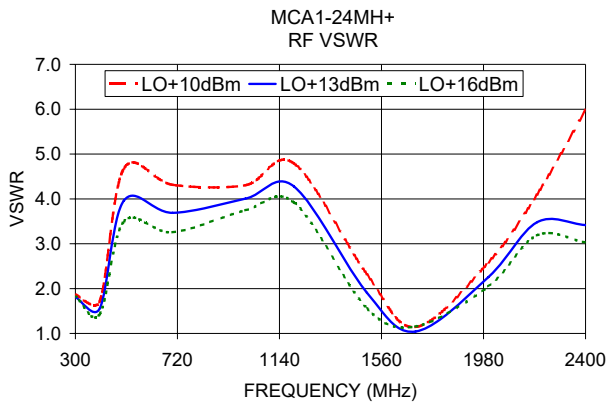
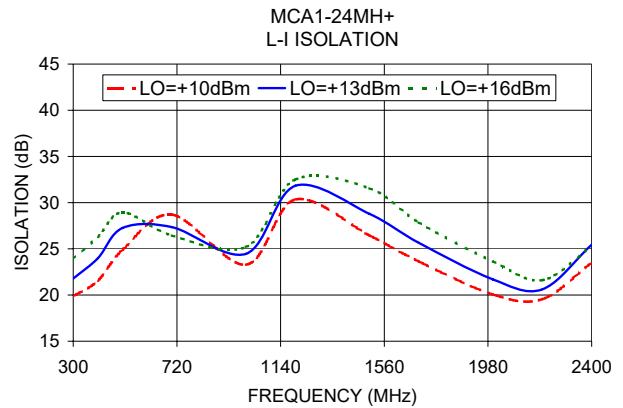
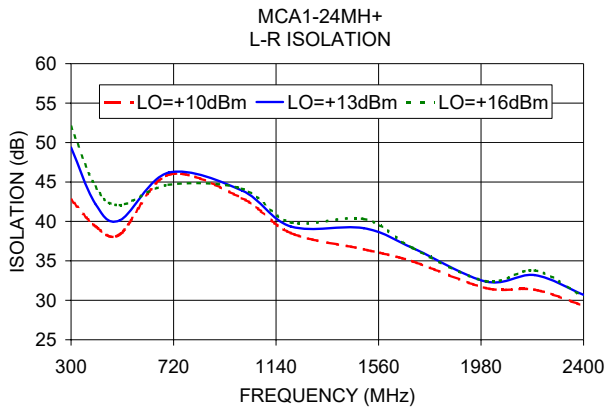
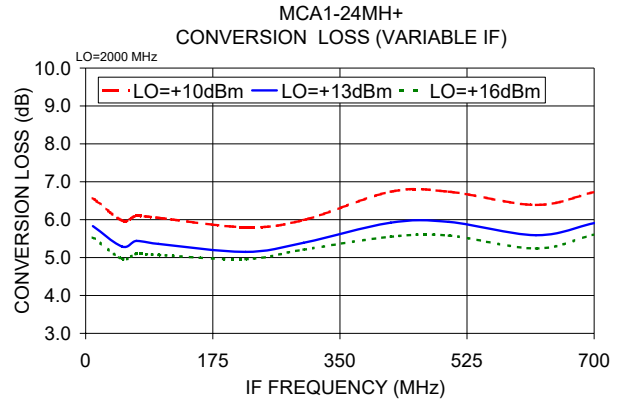
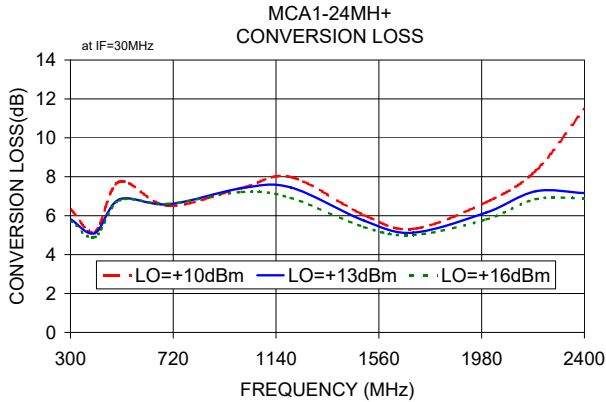

Notes

- A. Performance and quality attributes and conditions not expressly stated in this specification document are intended to be excluded and do not form a part of this specification document.
- B. Electrical specifications and performance data contained in this specification document are based on Mini-Circuit's applicable established test performance criteria and measurement instructions.
- C. The parts covered by this specification document are subject to Mini-Circuits standard limited warranty and terms and conditions (collectively, "Standard Terms"); Purchasers of this part are entitled to the rights and benefits contained therein. For a full statement of the Standard Terms and the exclusive rights and remedies thereunder, please visit Mini-Circuits' website at www.minicircuits.com/MCLStore/terms.jsp



Frequency Mixer

MCA1-24MH+

Typical Performance Data

RF (IN) (MHz)	LO (MHz)	CONVERSION LOSS IF FIXED @IF(OUT)=30MHz (dB)			RF (IN) (MHz)	LO (MHz)	IP3 INPUT (dBm)			RF (IN) (MHz)	LO (MHz)	COMPRESSION @RF IN=+9dBm (dB)		
		@LO (dBm)					@LO (dBm)					@LO (dBm)		
		+10	+13	+16			+10	+13	+16			+10	+13	+16
220.0	250.0	27.70	14.43	7.73	220.0	250.0	-4.93	2.43	12.69	220.0	250.0	-14.43	-3.87	0.55
300.0	330.0	7.10	5.51	5.29	300.0	330.0	8.92	14.10	18.25	300.0	330.0	2.65	2.01	1.30
380.0	410.0	5.25	4.84	4.63	380.0	410.0	13.71	18.56	22.38	380.0	410.0	3.31	2.83	2.52
460.0	490.0	6.90	5.93	5.37	460.0	490.0	11.04	14.23	16.71	460.0	490.0	2.60	2.74	2.70
540.0	570.0	7.37	6.44	5.97	540.0	570.0	13.00	16.37	18.09	540.0	570.0	1.55	1.69	1.63
620.0	650.0	6.40	6.20	6.05	620.0	650.0	15.41	14.47	15.50	620.0	650.0	1.39	1.18	1.07
700.0	730.0	6.10	5.83	5.77	700.0	730.0	14.93	17.60	16.92	700.0	730.0	1.16	0.87	0.63
780.0	810.0	6.66	6.06	5.79	780.0	810.0	20.42	18.36	15.36	780.0	810.0	0.87	0.85	0.77
860.0	890.0	6.97	6.53	6.27	860.0	890.0	22.43	27.09	28.04	860.0	890.0	0.84	0.59	0.50
940.0	970.0	6.78	6.41	6.23	940.0	970.0	17.00	19.54	22.78	940.0	970.0	1.02	0.72	0.54
1020.0	1050.0	6.70	6.46	6.32	1020.0	1050.0	22.13	23.17	23.99	1020.0	1050.0	0.93	0.63	0.49
1100.0	1130.0	7.12	6.65	6.41	1100.0	1130.0	22.88	21.12	21.16	1100.0	1130.0	1.21	0.91	0.75
1180.0	1210.0	7.91	6.91	6.37	1180.0	1210.0	16.21	19.25	21.56	1180.0	1210.0	1.30	1.27	1.16
1260.0	1290.0	8.74	7.49	6.80	1260.0	1290.0	15.72	16.66	17.23	1260.0	1290.0	1.18	1.36	1.35
1340.0	1370.0	6.96	6.47	6.18	1340.0	1370.0	19.03	14.93	13.68	1340.0	1370.0	1.96	1.64	1.46
1420.0	1450.0	6.55	5.85	5.42	1420.0	1450.0	12.63	13.48	13.73	1420.0	1450.0	1.68	1.40	1.39
1500.0	1530.0	6.23	5.57	5.11	1500.0	1530.0	9.74	10.21	13.51	1500.0	1530.0	1.76	1.60	1.52
1580.0	1610.0	5.47	4.81	4.71	1580.0	1610.0	14.81	19.63	19.83	1580.0	1610.0	2.01	1.19	0.89
1660.0	1690.0	5.25	4.85	4.79	1660.0	1690.0	18.08	22.23	20.11	1660.0	1690.0	1.83	1.04	0.74
1740.0	1770.0	5.34	5.06	5.02	1740.0	1770.0	15.41	20.85	22.60	1740.0	1770.0	1.83	1.01	0.74
1820.0	1850.0	5.72	5.21	5.11	1820.0	1850.0	23.25	16.18	20.10	1820.0	1850.0	1.77	1.27	0.96
1900.0	1930.0	5.67	5.09	4.96	1900.0	1930.0	11.77	15.71	21.23	1900.0	1930.0	1.74	1.28	0.91
1980.0	2010.0	6.90	5.86	5.36	1980.0	2010.0	13.69	15.22	17.24	1980.0	2010.0	1.43	1.47	1.43
2060.0	2090.0	7.84	6.68	6.04	2060.0	2090.0	13.70	17.17	19.86	2060.0	2090.0	1.12	1.16	1.23
2140.0	2170.0	8.13	6.83	6.25	2140.0	2170.0	13.08	14.85	16.72	2140.0	2170.0	1.25	0.95	0.88
2200.0	2230.0	8.08	6.61	6.20	2200.0	2230.0	12.42	14.87	18.19	2200.0	2230.0	1.10	0.85	0.65
2280.0	2310.0	8.98	6.60	6.14	2280.0	2310.0	11.22	14.52	21.27	2280.0	2310.0	0.45	0.85	0.60
2340.0	2370.0	10.83	6.53	6.14	2340.0	2370.0	7.40	18.21	21.83	2340.0	2370.0	-0.96	0.95	0.47
2420.0	2450.0	11.80	6.71	6.33	2420.0	2450.0	7.35	22.02	24.51	2420.0	2450.0	-1.53	0.98	0.46
2480.0	2510.0	10.67	7.17	6.88	2480.0	2510.0	9.70	18.89	23.24	2480.0	2510.0	-0.42	0.98	0.48
2560.0	2590.0	11.95	7.87	7.20	2560.0	2590.0	9.01	24.81	23.27	2560.0	2590.0	-0.85	0.82	0.50
2620.0	2650.0	11.56	8.41	7.49	2620.0	2650.0	11.16	25.56	22.04	2620.0	2650.0	-0.69	0.51	0.50
2700.0	2730.0	9.59	8.49	7.97	2700.0	2730.0	15.92	22.84	23.02	2700.0	2730.0	0.44	0.34	0.31
2760.0	2790.0	8.81	8.48	8.39	2760.0	2790.0	14.95	17.24	25.27	2760.0	2790.0	0.98	0.48	0.31
2840.0	2870.0	8.50	7.84	7.62	2840.0	2870.0	14.84	15.18	16.06	2840.0	2870.0	1.13	0.93	0.76
2900.0	2930.0	9.01	8.28	7.87	2900.0	2930.0	19.88	18.57	17.73	2900.0	2930.0	0.61	0.59	0.56
2980.0	3010.0	8.75	8.24	8.05	2980.0	3010.0	15.65	18.28	20.24	2980.0	3010.0	1.22	0.65	0.38
3040.0	3070.0	9.52	9.15	8.94	3040.0	3070.0	20.64	23.32	25.27	3040.0	3070.0	0.86	0.47	0.33
3120.0	3150.0	10.91	10.29	9.92	3120.0	3150.0	20.64	22.47	24.63	3120.0	3150.0	0.63	0.34	0.23
3180.0	3210.0	11.68	10.85	10.37	3180.0	3210.0	19.47	22.68	24.10	3180.0	3210.0	1.00	0.32	0.17

REV. X3
MCA1-24MH+
101027
Page 1 of 5



IF/RF MICROWAVE COMPONENTS • ISO 9001 ISO 14001 AS 9100 CERTIFIED • RoHS compliant
P.O. Box 350166, Brooklyn, New York 11235-0006 (718) 934-4500 Fax (718) 332-4661



The Design Engineers Search Engine finds the model you need, instantly • For detailed performance specs & shopping online see



Frequency Mixer

MCA1-24MH+

Typical Performance Data

IF (OUT) (MHz)	LO (MHz)	CONVERSION LOSS VS. IF FREQUENCY @RF(IN)=1210.1MHz (dB)	IF (OUT) (MHz)	LO (MHz)	CONVERSION LOSS VS. IF FREQUENCY @RF(IN)=289.9MHz (dB)	IF (OUT) (MHz)	LO (MHz)	CONVERSION LOSS VS. IF FREQUENCY @RF(IN)=2410.1MHz (dB)
		@LO (dBm)			@LO (dBm)			@LO (dBm)
		+13			+13			+13
770.1	440.0	9.69	10.1	300.0	6.40	830.1	1580.0	10.72
750.1	460.0	9.77	30.1	320.0	5.67	810.1	1600.0	9.85
730.1	480.0	9.53	50.1	340.0	5.61	790.1	1620.0	9.51
710.1	500.0	9.21	70.1	360.0	5.55	770.1	1640.0	9.04
690.1	520.0	8.68	90.1	380.0	5.47	750.1	1660.0	8.75
670.1	540.0	8.16	110.1	400.0	5.41	730.1	1680.0	8.59
650.1	560.0	7.59	130.1	420.0	5.41	710.1	1700.0	8.35
630.1	580.0	6.88	150.1	440.0	5.40	690.1	1720.0	8.29
610.1	600.0	6.19	170.1	460.0	5.56	670.1	1740.0	8.30
590.1	620.0	5.79	190.1	480.0	5.76	650.1	1760.0	8.06
570.1	640.0	5.80	210.1	500.0	5.85	630.1	1780.0	7.78
550.1	660.0	5.85	230.1	520.0	5.92	610.1	1800.0	7.69
530.1	680.0	6.09	250.1	540.0	5.96	590.1	1820.0	7.72
510.1	700.0	6.68	270.1	560.0	6.07	570.1	1840.0	7.58
490.1	720.0	7.23	290.1	580.0	6.09	550.1	1860.0	7.54
470.1	740.0	8.12	310.1	600.0	6.28	530.1	1880.0	7.57
450.1	760.0	8.62	330.1	620.0	6.35	510.1	1900.0	7.79
430.1	780.0	8.49	350.1	640.0	6.31	490.1	1920.0	7.94
410.1	800.0	8.66	370.1	660.0	6.06	470.1	1940.0	7.97
390.1	820.0	8.28	390.1	680.0	5.99	450.1	1960.0	8.03
370.1	840.0	8.20	410.1	700.0	6.15	430.1	1980.0	8.09
350.1	860.0	7.90	430.1	720.0	6.13	410.1	2000.0	8.26
330.1	880.0	7.59	450.1	740.0	6.68	390.1	2020.0	8.33
310.1	900.0	7.40	470.1	760.0	6.54	370.1	2040.0	8.37
290.1	920.0	7.33	490.1	780.0	6.21	350.1	2060.0	8.40
270.1	940.0	7.13	510.1	800.0	6.16	330.1	2080.0	8.43
250.1	960.0	6.88	530.1	820.0	6.05	310.1	2100.0	8.49
230.1	980.0	6.75	550.1	840.0	6.07	290.1	2120.0	8.39
210.1	1000.0	6.65	570.1	860.0	6.00	270.1	2140.0	8.13
190.1	1020.0	6.56	590.1	880.0	5.82	250.1	2160.0	7.91
170.1	1040.0	6.45	610.1	900.0	5.85	230.1	2180.0	7.77
150.1	1060.0	6.38	630.1	920.0	5.95	210.1	2200.0	7.67
130.1	1080.0	6.42	670.1	960.0	5.76	190.1	2220.0	7.31
110.1	1100.0	6.51	690.1	980.0	5.97	170.1	2240.0	7.14
90.1	1120.0	6.57	730.1	1020.0	6.26	150.1	2260.0	7.24
70.1	1140.0	6.57	750.1	1040.0	6.46	130.1	2280.0	7.34
50.1	1160.0	6.55	790.1	1080.0	7.00	90.1	2320.0	6.94
40.1	1170.0	6.60	810.1	1100.0	7.37	70.1	2340.0	6.79
20.1	1190.0	6.63	850.1	1140.0	8.54	30.1	2380.0	6.84
10.1	1200.0	6.69	870.1	1160.0	9.48	10.1	2400.0	6.93

Frequency Mixer

MCA1-24MH+

Typical Performance Data

LO (MHz)	LO-RF ISOLATION (dB)			LO-IF ISOLATION (dB)		
	@LO (dBm)			@LO (dBm)		
	+10	+13	+16	+10	+13	+16
250.0	49.05	48.55	51.46	25.78	25.90	25.56
330.0	45.23	47.17	45.74	20.21	21.61	23.83
410.0	40.26	41.20	41.68	20.50	23.30	25.54
490.0	39.14	40.22	41.11	22.31	24.57	26.43
570.0	67.09	57.41	53.00	25.41	28.15	29.98
650.0	46.01	44.48	44.18	28.00	28.13	27.49
730.0	43.60	42.39	41.15	27.82	26.55	25.60
810.0	42.47	41.84	41.37	33.45	31.83	30.30
890.0	40.70	41.33	41.71	28.81	30.17	31.18
970.0	40.60	41.25	41.79	23.43	24.93	26.16
1050.0	42.68	42.60	42.60	24.37	25.05	25.22
1130.0	44.11	43.24	42.78	28.42	28.23	27.79
1210.0	43.28	42.96	41.84	32.23	32.48	31.89
1290.0	46.68	45.21	43.16	33.72	35.89	35.91
1370.0	36.97	34.39	34.94	31.33	34.32	37.04
1450.0	50.16	46.47	43.14	29.18	31.75	34.95
1530.0	41.54	39.59	37.23	27.09	29.03	31.96
1610.0	38.36	35.16	33.12	26.12	29.74	33.83
1690.0	36.86	32.92	30.86	26.35	29.03	32.05
1770.0	38.40	36.46	34.41	22.99	25.05	27.45
1850.0	35.62	33.36	31.84	21.30	22.98	25.24
1930.0	34.46	33.07	32.06	20.21	21.95	24.03
2010.0	35.00	32.75	31.40	21.30	22.66	24.63
2090.0	38.53	34.83	32.70	24.25	27.00	29.88
2170.0	36.90	33.59	31.59	21.22	22.56	23.73
2230.0	38.58	34.94	32.17	21.03	22.24	22.95
2310.0	38.85	38.05	35.15	21.32	22.02	22.00
2370.0	37.84	36.82	34.95	23.21	24.84	24.35
2450.0	37.49	35.60	32.35	31.10	32.36	28.52
2510.0	41.15	35.60	30.30	39.48	35.17	29.11
2590.0	45.83	37.00	32.47	40.78	30.64	25.22
2650.0	46.38	36.45	32.55	36.40	27.27	23.35
2730.0	41.93	34.66	32.23	29.52	23.88	21.66
2790.0	36.74	32.21	30.29	25.59	22.62	21.07
2870.0	39.97	35.71	33.33	22.71	22.00	21.38
2930.0	36.78	35.29	34.12	21.91	22.26	22.24
3010.0	32.00	31.69	31.72	20.91	21.78	22.18
3070.0	31.14	31.16	31.42	19.49	20.88	21.99
3150.0	31.11	31.51	31.89	19.09	20.88	22.40
3210.0	32.64	33.11	33.45	19.35	21.31	23.08

RF (IN) (MHz)	LO (MHz)	RF-IF ISOLATION (dB)		
		@LO (dBm)		
		+10	+13	+16
220.0	250.0	32.11	27.24	24.41
300.0	330.0	21.55	18.53	18.01
380.0	410.0	16.33	15.74	15.42
460.0	490.0	14.59	14.15	13.92
540.0	570.0	20.22	19.31	18.65
620.0	650.0	28.73	27.72	26.88
700.0	730.0	31.87	30.82	28.79
780.0	810.0	32.83	30.22	28.19
860.0	890.0	30.43	28.80	27.80
940.0	970.0	31.48	30.68	30.18
1020.0	1050.0	38.55	38.17	38.02
1100.0	1130.0	31.26	30.75	30.41
1180.0	1210.0	27.04	26.65	26.38
1260.0	1290.0	23.18	22.41	22.26
1340.0	1370.0	23.65	21.46	19.97
1420.0	1450.0	22.25	21.91	21.78
1500.0	1530.0	23.44	22.50	21.97
1580.0	1610.0	22.94	23.14	23.33
1660.0	1690.0	23.24	22.73	22.56
1740.0	1770.0	23.02	22.74	22.51
1820.0	1850.0	23.42	22.80	22.59
1900.0	1930.0	22.07	20.97	20.68
1980.0	2010.0	30.30	28.83	27.37
2060.0	2090.0	26.56	25.79	25.12
2140.0	2170.0	28.80	24.28	22.65
2200.0	2230.0	40.08	40.57	32.20
2280.0	2310.0	26.28	25.15	23.74
2340.0	2370.0	26.15	24.46	23.20
2420.0	2450.0	30.11	28.13	25.78
2480.0	2510.0	21.93	21.70	20.76
2560.0	2590.0	17.83	18.96	18.53
2620.0	2650.0	17.82	18.06	17.72
2700.0	2730.0	17.69	16.95	16.55
2760.0	2790.0	16.97	16.21	15.74
2840.0	2870.0	16.63	16.15	15.75
2900.0	2930.0	16.82	16.37	15.92
2980.0	3010.0	15.84	15.42	15.07
3040.0	3070.0	15.09	14.81	14.58
3120.0	3150.0	14.52	14.23	14.00
3180.0	3210.0	14.35	14.03	13.72



Frequency Mixer

MCA1-24MH+

Typical Performance Data

RF (IN) (MHz)	LO (MHz)	RF VSWR (:1)		
		@LO (dBm)		
		+10	+13	+16
220.0	250.0	15.96	8.12	3.93
300.0	330.0	2.26	1.97	1.99
380.0	410.0	1.69	1.55	1.46
460.0	490.0	3.31	2.92	2.68
540.0	570.0	4.42	3.95	3.69
620.0	650.0	3.83	3.63	3.52
700.0	730.0	3.82	3.35	2.99
780.0	810.0	4.16	3.67	3.31
860.0	890.0	4.24	3.88	3.65
940.0	970.0	3.94	3.63	3.47
1020.0	1050.0	3.76	3.55	3.42
1100.0	1130.0	4.23	3.88	3.65
1180.0	1210.0	4.55	4.09	3.80
1260.0	1290.0	4.67	4.10	3.83
1340.0	1370.0	3.46	3.01	2.62
1420.0	1450.0	2.97	2.63	2.32
1500.0	1530.0	2.41	1.93	1.50
1580.0	1610.0	1.48	1.17	1.07
1660.0	1690.0	1.34	1.11	1.06
1740.0	1770.0	1.21	1.09	1.14
1820.0	1850.0	1.50	1.32	1.32
1900.0	1930.0	1.65	1.36	1.26
1980.0	2010.0	2.27	1.94	1.72
2060.0	2090.0	2.86	2.49	2.25
2140.0	2170.0	3.26	2.83	2.59
2200.0	2230.0	3.26	2.75	2.57
2280.0	2310.0	3.63	2.71	2.47
2340.0	2370.0	4.23	2.72	2.52
2420.0	2450.0	4.50	2.74	2.49
2480.0	2510.0	3.72	2.58	2.34
2560.0	2590.0	4.33	3.35	3.09
2620.0	2650.0	4.78	3.91	3.60
2700.0	2730.0	4.45	4.01	3.79
2760.0	2790.0	4.15	3.89	3.76
2840.0	2870.0	4.18	3.84	3.62
2900.0	2930.0	4.34	3.97	3.68
2980.0	3010.0	3.81	3.51	3.33
3040.0	3070.0	4.03	3.82	3.67
3120.0	3150.0	4.50	4.27	4.09
3180.0	3210.0	4.70	4.43	4.23

LO (MHz)	LO VSWR (:1)		
	@LO (dBm)		
	+10	+13	+16
250.0	28.96	28.03	20.95
330.0	13.49	7.00	6.28
410.0	2.59	2.95	3.82
490.0	1.34	1.88	2.62
570.0	1.36	1.38	1.93
650.0	1.77	1.62	2.09
730.0	1.99	2.08	2.65
810.0	2.31	2.78	3.58
890.0	2.58	3.27	4.25
970.0	2.40	3.31	4.45
1050.0	2.47	3.43	4.62
1130.0	3.23	3.92	4.91
1210.0	3.97	4.24	4.95
1290.0	4.63	4.31	4.61
1370.0	4.66	4.20	4.32
1450.0	4.32	3.43	3.52
1530.0	3.56	2.31	2.23
1610.0	3.54	2.21	2.03
1690.0	3.11	1.92	1.78
1770.0	2.48	1.56	1.59
1850.0	2.50	1.84	1.88
1930.0	2.70	2.21	2.28
2010.0	3.30	2.59	2.59
2090.0	4.35	3.00	2.77
2170.0	5.97	3.30	2.63
2230.0	7.02	3.63	2.63
2310.0	8.95	4.41	2.63
2370.0	10.31	5.95	2.98
2450.0	10.96	6.07	3.02
2510.0	10.31	5.10	2.71
2590.0	9.58	4.63	2.75
2650.0	8.68	4.08	2.72
2730.0	6.03	3.33	2.92
2790.0	4.30	3.20	3.24
2870.0	3.31	3.21	3.58
2930.0	2.92	3.23	3.73
3010.0	2.52	2.98	3.53
3070.0	2.26	2.82	3.38
3150.0	2.41	2.85	3.27
3210.0	2.75	3.06	3.36

IF (OUT) (MHz)	IF VSWR @LO=2400MHz (:1)		
	@LO (dBm)		
	+10	+13	+16
10.0	2.49	1.08	1.22
30.0	2.56	1.10	1.21
50.0	2.62	1.14	1.18
70.0	2.55	1.17	1.23
90.0	2.65	1.21	1.21
110.0	2.69	1.25	1.25
130.0	2.84	1.31	1.24
150.0	2.91	1.36	1.28
170.0	3.03	1.42	1.32
190.0	3.09	1.43	1.34
210.0	3.28	1.50	1.36
230.0	3.44	1.56	1.38
250.0	3.60	1.64	1.44
270.0	3.72	1.64	1.42
290.0	3.91	1.71	1.45
310.0	4.13	1.77	1.44
330.0	4.35	1.88	1.52
350.0	4.48	1.92	1.52
370.0	4.59	1.96	1.54
390.0	4.70	2.03	1.55
410.0	4.79	2.09	1.60
430.0	4.98	2.17	1.65
450.0	4.93	2.15	1.63
470.0	5.07	2.21	1.66
490.0	5.10	2.20	1.65
510.0	5.27	2.28	1.71
530.0	5.19	2.21	1.66
550.0	5.19	2.24	1.69
570.0	5.17	2.18	1.66
590.0	5.19	2.20	1.69
610.0	5.12	2.16	1.70
630.0	5.04	2.12	1.70
650.0	4.98	2.11	1.76
670.0	4.84	2.10	1.83
690.0	4.78	2.17	1.97
710.0	4.53	2.16	2.08
730.0	4.39	2.28	2.29
750.0	4.14	2.42	2.58
790.0	3.77	2.92	3.30
810.0	3.64	3.19	3.63

Harmonics Tables

RF HARMONICS ORDER

	(-dBm)	(-dBc)										
0	-	-	9	21	8	24	20	26	40	46	44	51
1	-	16	+0	21	39	27	39	46	35	46	41	48
2	66	51	60	42	53	55	48	54	57	61	63	57
3	>90	51	68	56	67	53	57	68	66	69	62	65
4	>90	>78	>78	>78	>78	71	73	>78	>78	>78	78	76
5	>90	>78	>78	>78	>78	>78	>78	>78	>78	>78	>78	>78
6	>90	>78	>78	>78	>78	>78	>78	>78	>78	>78	>78	>78
7	>90	>78	>78	>78	>78	>78	>78	>78	>78	77	>78	>78
8	>90	>78	>78	>78	>78	>78	>78	>78	>78	>78	>78	>78
9	>90	>78	>78	>78	>78	>78	>78	>78	>78	>78	>78	>78
10	>90	>78	>78	>78	>78	>78	>78	>78	>78	>78	>78	>78
	RF CAL	0	1	2	3	4	5	6	7	8	9	10

Test conditions:

RF IN: 1350 MHz; -6.00 dBm.
 LO IN: 1380 MHz; +13.00 dBm
 IF OUT: 30 MHz; -12.21 dBm

RF HARMONICS ORDER

	(-dBm)	(-dBc)										
0	-	-	20	35	20	38	32	37	57	66	55	67
1	-	15	+0	26	33	30	45	54	46	62	55	61
2	46	41	53	37	44	46	41	50	52	55	77	61
3	>90	33	41	41	30	39	51	56	69	65	56	57
4	>90	66	57	56	57	51	53	67	56	62	64	72
5	>90	55	59	46	61	58	44	52	53	58	61	67
6	>90	60	62	81	67	61	67	69	60	83	63	78
7	>90	64	60	71	71	59	63	79	54	65	60	63
8	>90	77	81	60	71	73	81	71	>88	67	69	83
9	>90	78	86	>88	71	74	75	73	71	87	62	78
10	>90	>88	87	>88	>88	76	87	81	83	84	>88	82
	RF CAL	0	1	2	3	4	5	6	7	8	9	10

LO HARMONICS ORDER

Test conditions:

RF IN: 1350 MHz; 4.00 dBm.
 LO IN: 1380 MHz; +13.00 dBm
 IF OUT: 30 MHz; -2.3 dBm

- Notes:
1. All Harmonics are in (dBc) relative to IF OUTPUT.
 2. + entry denotes harmonics are in (dBc) above IF OUTPUT.
 3. RF Cal represent the Harmonics level of the RF input signal to the mixer.

Frequency Mixer

MCA1-24MH+

Typical Performance Curves

Conversion Loss @ IF=30MHz

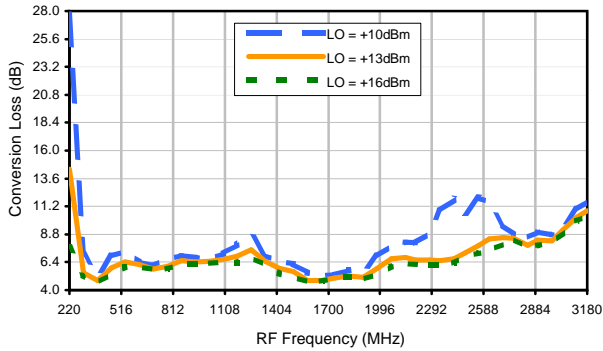

Conversion Loss vs. IF @ RF=1210.1MHz

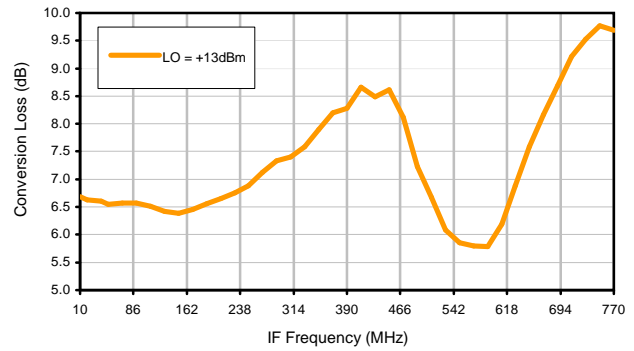

Conversion Loss vs. IF @ RF=289.9MHz

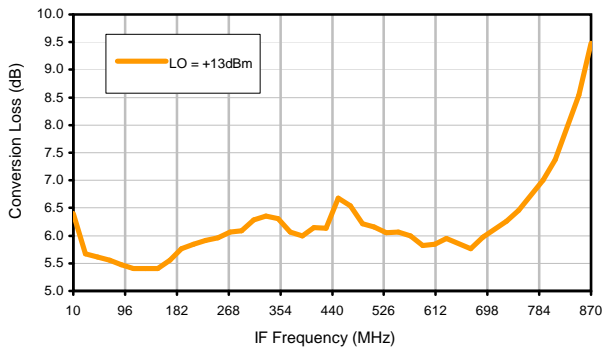

Conversion Loss vs. IF @ RF=2410.1MHz

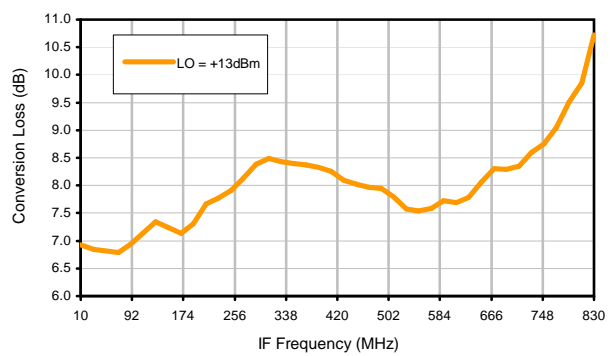

IP3 Input

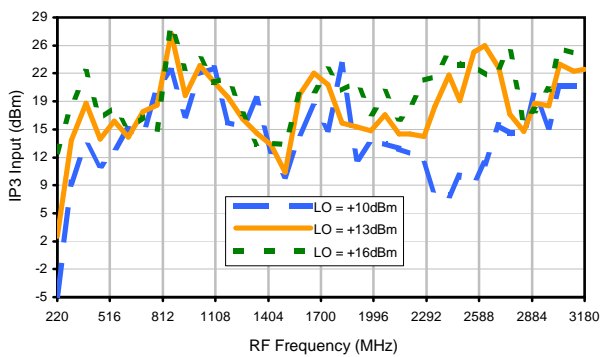

Compression @ RF IN=+9dBm

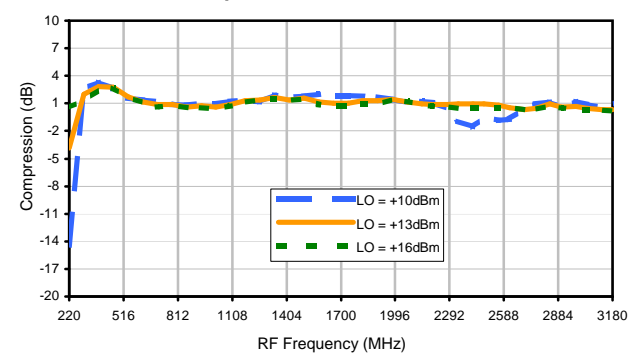

Typical Performance Curves

LO-RF Isolation

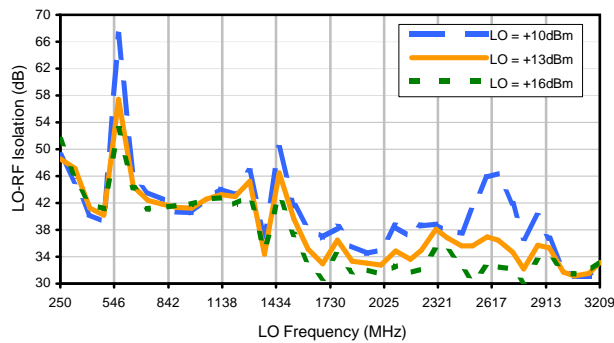

LO-IF Isolation

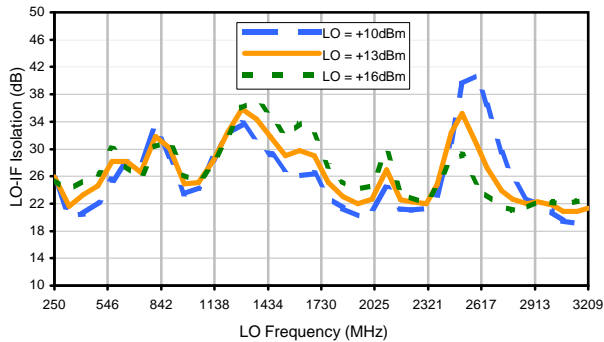

RF-IF Isolation

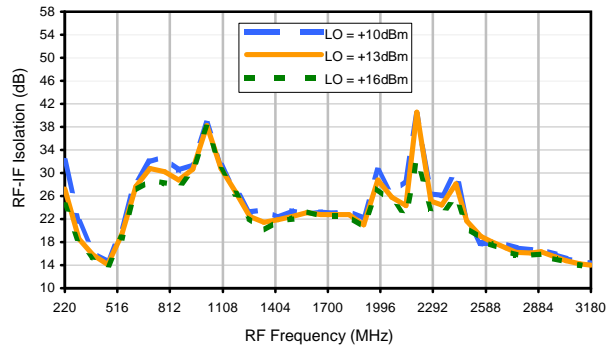

RF VSWR

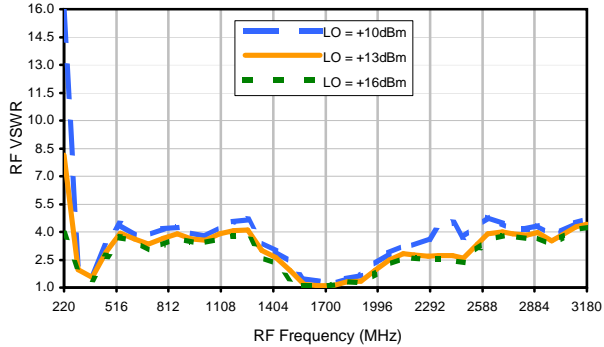

LO VSWR

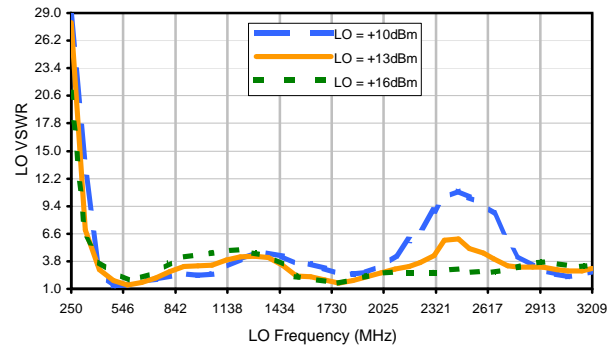

IF VSWR

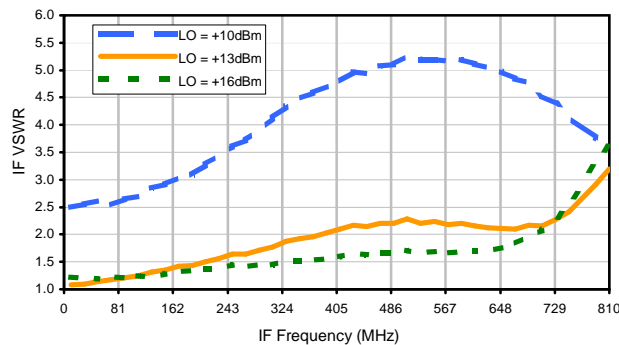

Harmonics Tables

RF HARMONICS ORDER

	(-dBm)	(-dBc)										
0	-	-	9	21	8	24	20	26	40	46	44	51
1	-	16	+0	21	39	27	39	46	35	46	41	48
2	66	51	60	42	53	55	48	54	57	61	63	57
3	>90	51	68	56	67	53	57	68	66	69	62	65
4	>90	>78	>78	>78	>78	71	73	>78	>78	>78	78	76
5	>90	>78	>78	>78	>78	>78	>78	>78	>78	>78	>78	>78
6	>90	>78	>78	>78	>78	>78	>78	>78	>78	>78	>78	>78
7	>90	>78	>78	>78	>78	>78	>78	>78	>78	77	>78	>78
8	>90	>78	>78	>78	>78	>78	>78	>78	>78	>78	>78	>78
9	>90	>78	>78	>78	>78	>78	>78	>78	>78	>78	>78	>78
10	>90	>78	>78	>78	>78	>78	>78	>78	>78	>78	>78	>78
	RF CAL	0	1	2	3	4	5	6	7	8	9	10

Test conditions:

RF IN: 1350 MHz; -6.00 dBm.
 LO IN: 1380 MHz; +13.00 dBm
 IF OUT: 30 MHz; -12.21 dBm

RF HARMONICS ORDER

	(-dBm)	(-dBc)										
0	-	-	20	35	20	38	32	37	57	66	55	67
1	-	15	+0	26	33	30	45	54	46	62	55	61
2	46	41	53	37	44	46	41	50	52	55	77	61
3	>90	33	41	41	30	39	51	56	69	65	56	57
4	>90	66	57	56	57	51	53	67	56	62	64	72
5	>90	55	59	46	61	58	44	52	53	58	61	67
6	>90	60	62	81	67	61	67	69	60	83	63	78
7	>90	64	60	71	71	59	63	79	54	65	60	63
8	>90	77	81	60	71	73	81	71	>88	67	69	83
9	>90	78	86	>88	71	74	75	73	71	87	62	78
10	>90	>88	87	>88	>88	76	87	81	83	84	>88	82
	RF CAL	0	1	2	3	4	5	6	7	8	9	10

LO HARMONICS ORDER

Test conditions:

RF IN: 1350 MHz; 4.00 dBm.
 LO IN: 1380 MHz; +13.00 dBm
 IF OUT: 30 MHz; -2.3 dBm

- Notes:
1. All Harmonics are in (dBc) relative to IF OUTPUT.
 2. + entry denotes harmonics are in (dBc) above IF OUTPUT.
 3. RF Cal represent the Harmonics level of the RF input signal to the mixer.

Outline Dimensions

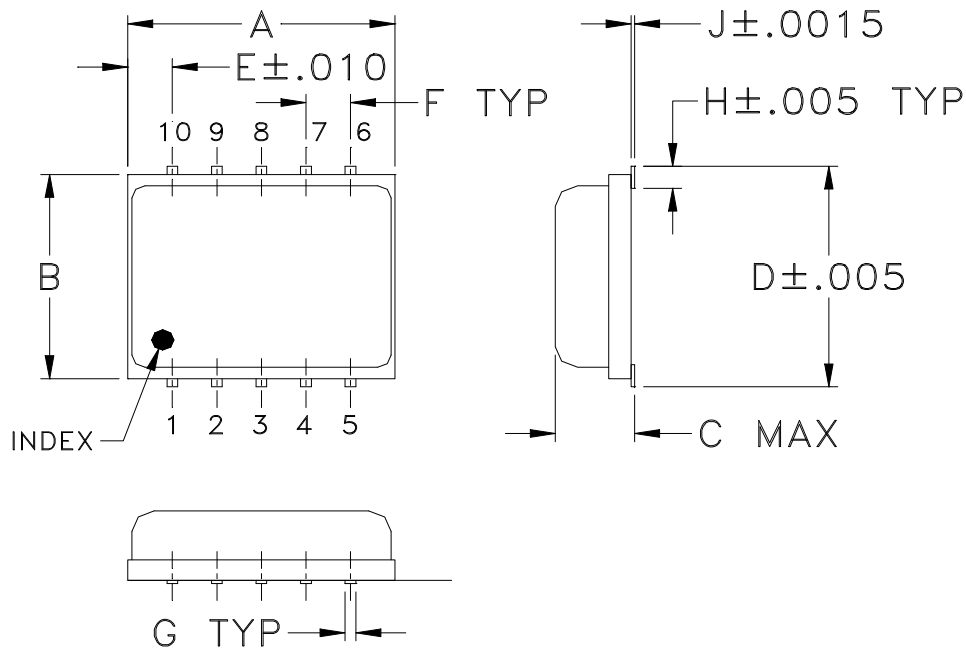

PCB Land Pattern

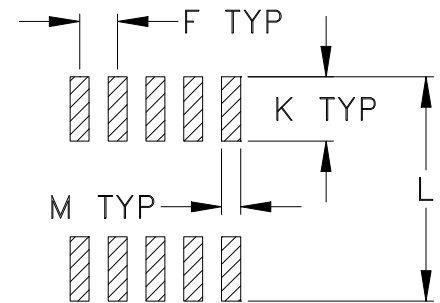

Suggested Layout,
Tolerance to be within $\pm .002$

CASE#	A	B	C	D	E	F	G	H	J	K	L	M	WT. GRAMS
DZ885	.30 (7.62)	.250 (6.35)	.085 (2.16)	.266 (6.76)	.050 (1.27)	.050 (1.27)	.012 (0.30)	.029 (0.74)	.004 (0.10)	.085 (2.16)	.296 (7.52)	.030 (0.76)	0.25
DZ1034			.105 (2.67)										0.3

Dimensions are in inches (mm). Tolerances: 2Pl. $\pm .01$; 3Pl. $\pm .005$

Notes:

- Case material: Plastic encapsulation on Ceramic base.
- Termination finish:
 - For RoHS Case Styles: Tin plate. All models, (+) suffix.
 - For RoHS-5 Case Styles: Tin-Lead plate. All models, no (+) suffix.

Tape & Reel Packaging TR-F34

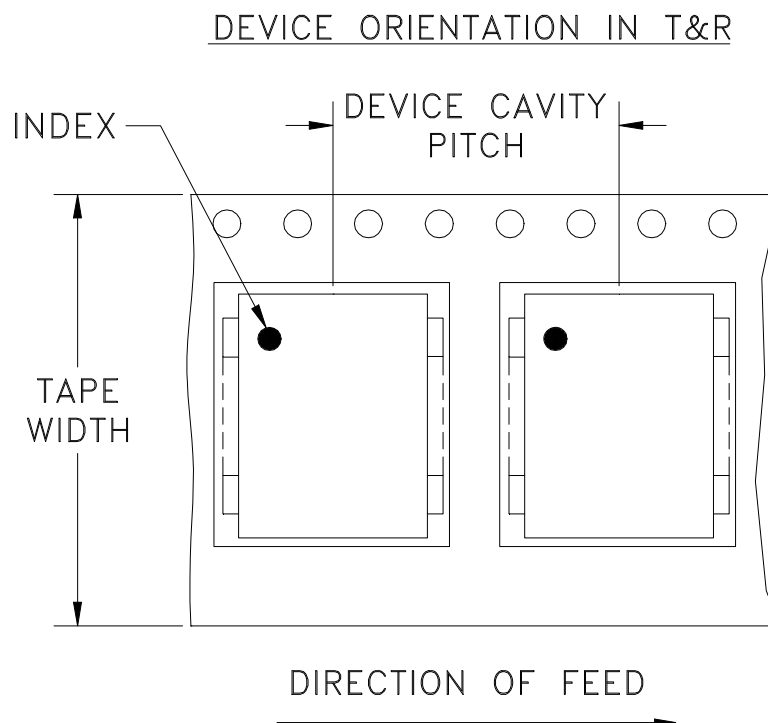

Tape Width, mm	Device Cavity Pitch, mm	Reel Size, inches	Devices per Reel see note	
16	12	7	Small quantity standard (see note)	20
				50
			100	
			200	
		13	Standard	500
				1000

Note: Availability of small reel quantity varies by model.
Refer to pricing and availability on individual model dashboard.

Mini-Circuits carrier tape materials provide protection from ESD (Electro-Static Discharge) during handling and transportation. Tapes are static dissipative and comply with industry standards EIA-481/EIA-541.

Go to: www.minicircuits.com/pages/pdfs/tape.pdf



INTERNET <http://www.minicircuits.com>

P.O. Box 350166, Brooklyn, New York 11235-0003 (718) 934-4500 Fax (718) 332-4661

Distribution Centers NORTH AMERICA 800-654-7949 • 417-335-5935 • Fax 417-335-5945 • EUROPE 44-1252-832600 • Fax 44-1252-837010

Mini-Circuits ISO 9001 & ISO 14001 Certified

THIRD ANGLE PROJECTION

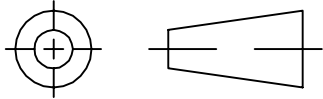

REVISIONS

REV	ECN No.	DESCRIPTION	DATE	DR	AUTH
A	M81781	UPDATED PCB LAYOUT	06/07/02	GF	DJ
B	M82377	UPDATED DRAWING	07/31/02	AV	WL
C	M102713	ADDED NOTE 2 & "...WITH SMOBC"	01/17/06	MMG	IL
D	M135488	ADDED DZ1650, CHANGED PIN CONN.	02/02/12	GF	DJ

**SUGGESTED MOUNTING CONFIGURATION FOR
DZ883, DZ885 & DZ1650 CASE STYLES, "10MX01" PIN CONNECTION**

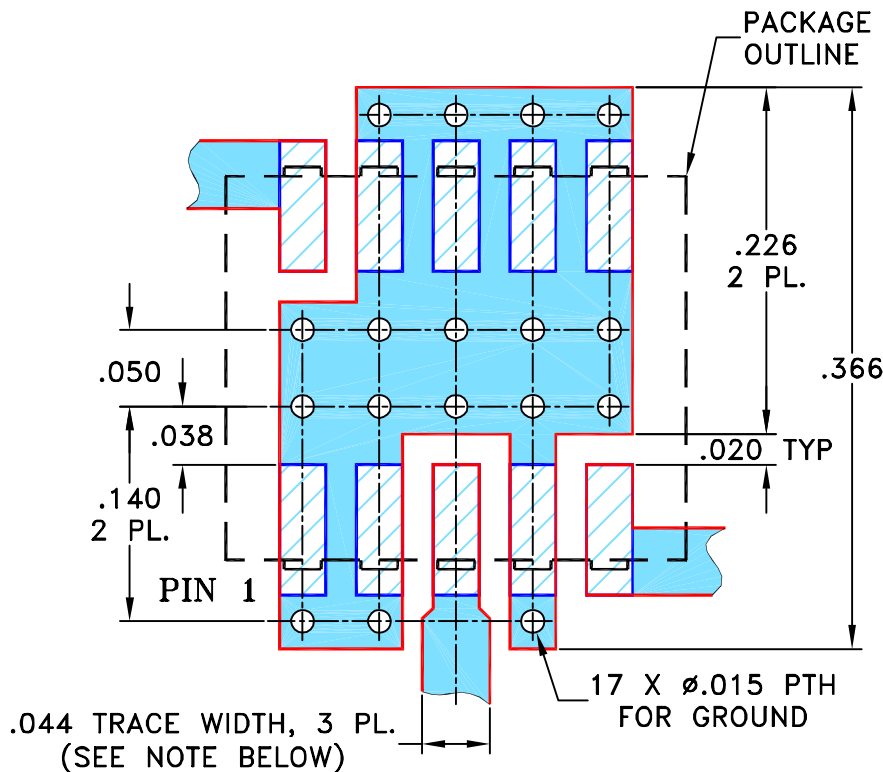

- NOTES: 1. TRACE WIDTH IS SHOWN FOR ROGERS R04350B WITH DIELECTRIC THICKNESS .020" ± .0015"; COPPER: 1/2 OZ. EACH SIDE. FOR OTHER MATERIALS TRACE WIDTH MAY NEED TO BE MODIFIED.
2. BOTTOM SIDE OF THE PCB IS CONTINUOUS GROUND PLANE.



DENOTES PCB COPPER LAYOUT WITH SMOBC (SOLDER MASK OVER BARE COPPER)



DENOTES COPPER LAND PATTERN FREE OF SOLDER MASK

UNLESS OTHERWISE SPECIFIED

INITIALS

DATE

DIMENSIONS ARE IN INCHES

DRAWN

AV

05/08/02

TOLERANCES ON:

CHECKED

DB

05/16/02

2 PL DECIMALS ± .005

APPROVED

WL

05/16/02

ANGLES ±

FRACTIONS ±

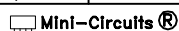

THIS DOCUMENT AND ITS CONTENTS ARE THE PROPERTY OF MINI-CIRCUITS. EXCEPT FOR USE EXPRESSLY GRANTED, IN WRITING, TO ITS VENDORS, VENDEE AND THE UNITED STATES GOVERNMENT, MINI-CIRCUITS RESERVES ALL PROPRIETARY DESIGN, USE, MANUFACTURING AND REPRODUCTION RIGHTS THERETO. THESE CONTENTS SHALL NOT BE USED, DUPLICATED OR DISCLOSED TO ANY OUTSIDE PARTY, IN WHOLE OR IN PART, WITHOUT WRITTEN PERMISSION OF MINI-CIRCUITS.



Mini-Circuits®

13 Neptune Avenue
Brooklyn NY 11235

PL, 10MX01, DZ883/885/1650, TB-144

SIZE

CODE IDENT

DRAWING NO:

REV:

A

15542

98-PL-045

D

FILE: 98PL045

SCALE:

8:1

SHEET:

1 OF 1

Evaluation Board and Circuit

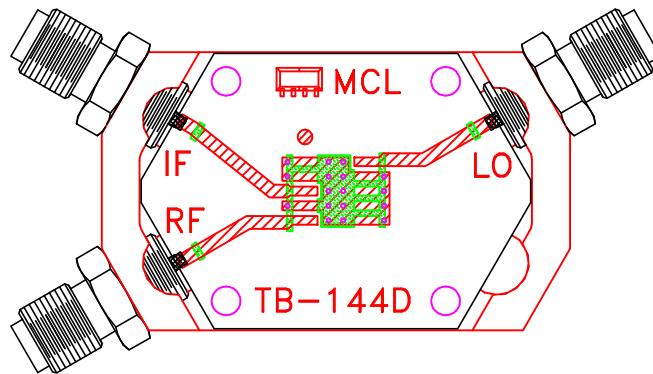

TB-144

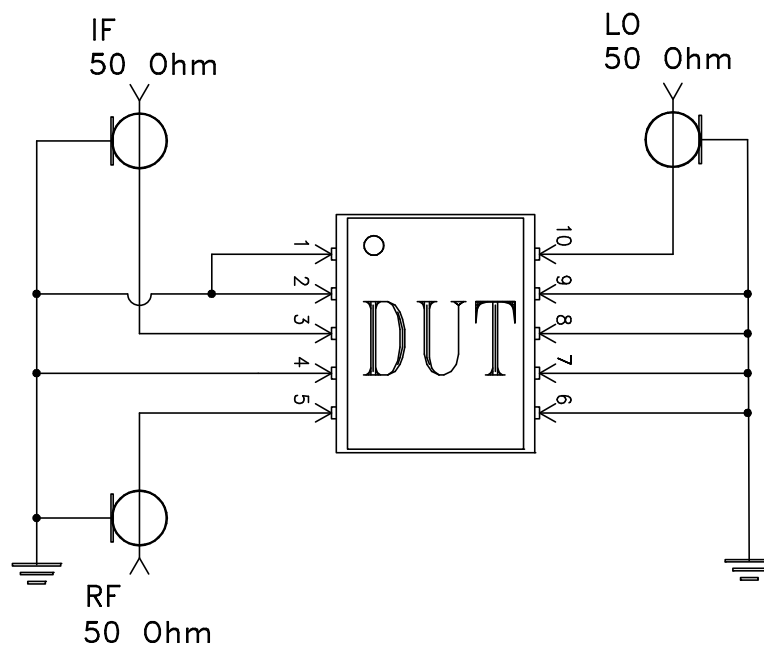

Schematic Diagram

Notes:

1. SMA Female connectors.
2. PCB Material: Rogers R04350 or equivalent,
Dielectric Constant=3.5, Thickness=.020 inch.

 **Mini-Circuits®**

All Mini-Circuits products are manufactured under exacting quality assurance and control standards, and are capable of meeting published specifications after being subjected to any or all of the following physical and environmental test.

Specification	Test/Inspection Condition	Reference/Spec
Operating Temperature	-55° to 100°C Ambient Environment	Individual Model Data Sheet
Storage Temperature	-55° to 100° C Ambient Environment	Individual Model Data Sheet
Autoclave	15 psig, 100% RH, 121°C, 96 hours	JESD22-A102-C, Condition C
Thermal Shock	-55° to 100°C, 100 cycles	MIL-STD-202, Method 107, Condition A-3, except +100°C
Solder Reflow Heat	Sn-Pb Eutectic Process: 225°C peak Pb-Free Process: 250°C peak	J-STD-020, Table 4-1, 4-2 and 5-2; Figure 5-1
Solderability	10X Magnification	J-STD-002, Para 4.2.5, Test S, 95% Coverage
Vibration (High Frequency)	20g peak, 10-2000 Hz, 12 times in each of three perpendicular directions (total 36)	MIL-STD-202, Method 204, Condition D
Mechanical Shock	50g, 11 ms, 1/2-sine, 18 shocks: 3 each direction, each of 3 axes	MIL-STD-202, Method 213, Condition A
Marking Resistance to Solvents	Isopropyl alcohol + mineral spirits at 25°C; terpene defluxer at 25°C; distilled water + proylene glycol monomethyl ether + monoethanolamine at 63°C to 70°C	MIL-STD-202, Method 215