

Surface Mount Monolithic Amplifier

DC-4 GHz

Product Features

- DC-4 GHz
- Single Voltage Supply
- Internally Matched to 50 Ohms
- Unconditionally Stable
- Low Performance Variation Over Temperature
- Transient Protected
- Aqueous washable
- Protected By US Patent 6,943,629

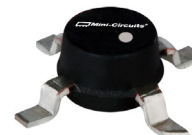

Generic photo used for illustration purposes only

ERA-6SM+

CASE STYLE: WW107

+RoHS Compliant

The +Suffix identifies RoHS Compliance. See our web site for RoHS Compliance methodologies and qualifications

Typical Applications

- Cellular/ PCS/ 3G Base Station
- CATV, Cable Modem & DBS
- Fixed Wireless & WLAN
- Microwave Radio & Test Equipment

General Description

ERA-6SM+ (RoHS compliant) is a wideband amplifier offering high dynamic range. It has repeatable performance from lot to lot. It is enclosed in a Micro-X package. ERA-6SM+ uses Darlington configuration and is fabricated using InGaP HBT technology. Expected MTTF is 350 years at 85°C case temperature.

simplified schematic and pin description

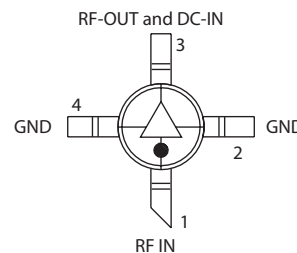
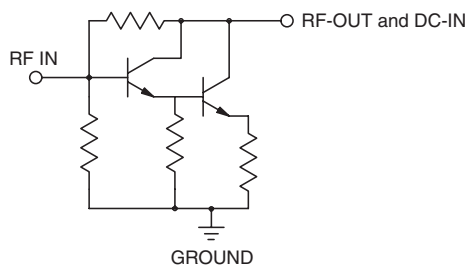

Function	Pin Number	Description
RF IN	1	RF input pin. This pin requires the use of an external DC blocking capacitor chosen for the frequency of operation.
RF-OUT and DC-IN	3	RF output and bias pin. DC voltage is present on this pin; therefore a DC blocking capacitor is necessary for proper operation. An RF choke is needed to feed DC bias without loss of RF signal due to the bias connection, as shown in "Recommended Application Circuit".
GND	2,4	Connections to ground. Use via holes as shown in "Suggested Layout for PCB Design" to reduce ground path inductance for best performance.

Notes

- A. Performance and quality attributes and conditions not expressly stated in this specification document are intended to be excluded and do not form a part of this specification document.
 B. Electrical specifications and performance data contained in this specification document are based on Mini-Circuit's applicable established test performance criteria and measurement instructions.
 C. The parts covered by this specification document are subject to Mini-Circuits' standard limited warranty and terms and conditions (collectively, "Standard Terms"); Purchasers of this part are entitled to the rights and benefits contained therein. For a full statement of the Standard Terms and the exclusive rights and remedies thereunder, please visit Mini-Circuits' website at www.minicircuits.com/MCLStore/terms.jsp



Electrical Specifications at 25°C and 70mA, unless noted

Parameter	Min.	Typ.	Max.	Units	Cpk	
Frequency Range*	DC		4	GHz		
Gain	f=0.1 GHz	12	12.6	13.3	dB	≥ 1.5
	f=1 GHz	—	12.5	—		
	f=2 GHz	11.1	11.7	12.3		
	f=3 GHz	—	11.7	—		
	f=4 GHz	9.8	10.3	10.8		
Magnitude of Gain Variation versus Temperature (values are negative)	f=0.1 GHz	—	0.0013	.0025	dB/°C	
	f=1 GHz	—	0.0018	.0035		
	f=2 GHz	—	0.0021	.004		
	f=3 GHz	—	0.0025	.005		
	f=4 GHz	—	0.0032	.007		
Input Return Loss	f=0.1 GHz		25		dB	
	f=1 GHz		30			
	f=2 GHz		35			
	f=3 GHz		33			
	f=4 GHz		28			
Output Return Loss	f=0.1 GHz		35		dB	
	f=1 GHz		24			
	f=2 GHz		20			
	f=3 GHz		20			
	f=4 GHz		20			
Reverse Isolation	f=2 GHz	16	19	—	dB	
Output Power @ 1 dB compression	f=0.1 GHz	—	17.1	—	dBm	≥ 1.33
	f=1 GHz	16	17.2	—		
	f=2 GHz	—	17.1	—		
	f=3 GHz	—	16.2	—		
	f=4 GHz	—	14.7	—		
Saturated Output Power (at 3dB compression)	f=0.1 GHz		17.1		dBm	
	f=1 GHz		17.2			
	f=2 GHz		17.7			
	f=3 GHz		17.3			
	f=4 GHz		15.9			
Output IP3	f=0.1 GHz	34	36.5	—	dBm	≥ 1.33
	f=1 GHz	33	35	—		
	f=2 GHz	31	33	—		
	f=3 GHz	—	30	—		
	f=4 GHz	—	28.5	—		
Noise Figure	f=0.1 GHz	—	4.4	5.2	dB	
	f=1 GHz	—	4.4	5.5		
	f=2 GHz	—	4.5	5.5		
	f=3 GHz	—	4.5	6		
	f=4 GHz	—	4.7	6		
Group Delay	f=2 GHz		80		psec	
Recommended Device Operating Current			70		mA	
Device Operating Voltage	4.7	5	5.3	V	≥ 1.5	
Device Voltage Variation vs. Temperature at 70mA			-3.2	mV/°C		
Device Voltage Variation vs. Current at 25°C			11.8	mV/mA		
Thermal Resistance, junction-to-case ¹			143	°C/W		

*Guaranteed specification DC-4 GHz. Low frequency cut off determined by external coupling capacitors.

Absolute Maximum Ratings

Parameter	Ratings
Operating Temperature*	-45°C to 85°C
Storage Temperature	-65°C to 150°C
Operating Current	85mA
Power Dissipation	451mW
Input Power	20dBm

Note: Permanent damage may occur if any of these limits are exceeded. These ratings are not intended for continuous normal operation.
¹Case is defined as ground leads.
 *Based on typical case temperature rise 5°C above ambient.

Notes

- A. Performance and quality attributes and conditions not expressly stated in this specification document are intended to be excluded and do not form a part of this specification document.
- B. Electrical specifications and performance data contained in this specification document are based on Mini-Circuit's applicable established test performance criteria and measurement instructions.
- C. The parts covered by this specification document are subject to Mini-Circuits standard limited warranty and terms and conditions (collectively, "Standard Terms"); Purchasers of this part are entitled to the rights and benefits contained therein. For a full statement of the Standard Terms and the exclusive rights and remedies thereunder, please visit Mini-Circuits' website at www.minicircuits.com/MCLStore/terms.jsp



Product Marking

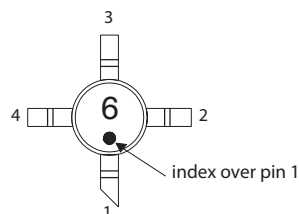

Markings in addition to model number designation may appear for internal quality control purposes.

Additional Detailed Technical Information

Additional information is available on our web site. To access this information enter the model number on our web site home page.

Performance data, graphs, s-parameter data set (.zip file)

Case Style: WW107

Plastic micro-x, .085 body diameter, lead finish: Matte-Tin

Tape & Reel: F4

7" Reels with 20, 50, 100, 200, 500, 1K devices

Suggested Layout for PCB Design: PL-075

Evaluation Board: TB-408-6+

Environmental Ratings: ENV08T2

Recommended Application Circuit

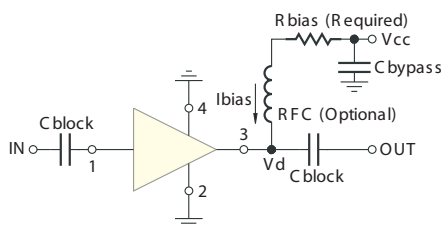

Test Board includes case, connectors, and components (in bold) soldered to PCB

R BIAS	
Vcc	"1%" Res. Values (ohms) for Optimum Biasing
7	30.1
8	43.2
9	56.2
10	69.8
11	84.5
12	100
13	113
14	127
15	140
16	154
17	169
18	182
19	196
20	210

Notes

- A. Performance and quality attributes and conditions not expressly stated in this specification document are intended to be excluded and do not form a part of this specification document.
- B. Electrical specifications and performance data contained in this specification document are based on Mini-Circuit's applicable established test performance criteria and measurement instructions.
- C. The parts covered by this specification document are subject to Mini-Circuits standard limited warranty and terms and conditions (collectively, "Standard Terms"); Purchasers of this part are entitled to the rights and benefits contained therein. For a full statement of the Standard Terms and the exclusive rights and remedies thereunder, please visit Mini-Circuits' website at www.minicircuits.com/MCLStore/terms.jsp



ESD Rating

Human Body Model (HBM): Class 1B (500 v to < 1,000 v) in accordance with ANSI/ESD STM 5.1 - 2001

Machine Model (MM): Class M1 (< 100 v) in accordance with ANSI/ESD STM 5.2 - 1999

MSL Rating

Moisture Sensitivity: MSL1 in accordance with IPC/JEDECJ-STD-020C

No.	Test Required	Condition	Standard	Quantity
1	Visual Inspection	Low Power Microscope Magnification 40x	MIP-IN-0003 (MCT spec)	45 units
2	Electrical Test	Room Temperature	SCD (MCL spec)	45 units
3	SAM Analysis	Less than 10% growth in term of delamination	J-Std-020C (Jedec Standard)	45 units
4	Moisture Sensitivity Level 1	Bake at 125°C for 24 hours Soak at 85°C/85%RH for 168 hours Reflow 3 cycles at 260°C peak	J-Std-020C (Jedec Standard)	45 units

MSL Test Flow Chart

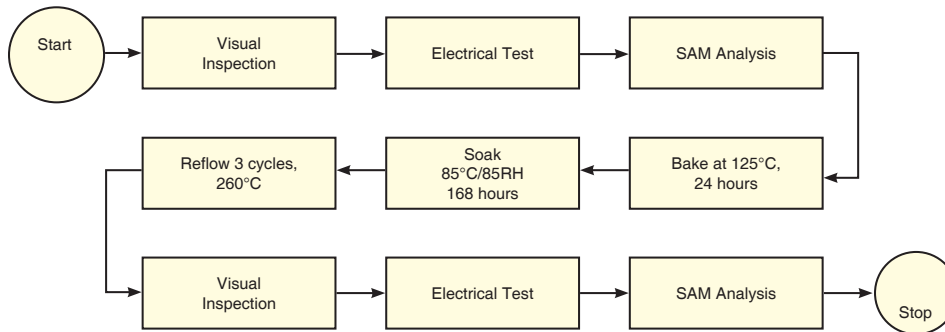

Notes

- A. Performance and quality attributes and conditions not expressly stated in this specification document are intended to be excluded and do not form a part of this specification document.
- B. Electrical specifications and performance data contained in this specification document are based on Mini-Circuit's applicable established test performance criteria and measurement instructions.
- C. The parts covered by this specification document are subject to Mini-Circuits standard limited warranty and terms and conditions (collectively, "Standard Terms"); Purchasers of this part are entitled to the rights and benefits contained therein. For a full statement of the Standard Terms and the exclusive rights and remedies thereunder, please visit Mini-Circuits' website at www.minicircuits.com/MCLStore/terms.jsp



MMIC Amplifier

ERA-6SM+

Typical Performance Data

NOTE: Use PDF Bookmarks to view DATA at required conditions or to view GRAPHS.

Definitions:

Input Return Loss = -S11 (dB)

Gain(Power Gain) = S21 (dB)

Reverse Isolation = -S12 (dB)

Output Return Loss = -S22 (dB)

TEST CONDITIONS: Icc = 70mA, Vd = 4.84V @Temperature = +25degC

FREQ	Gain	Isolation	Input Return Loss	Output Return Loss	Stability		IP3 Output	1dB Comp. Output	Noise Figure
					K	Delta			
(MHz)	(dB)	(dB)	(dB)	(dB)	K	Delta	(dBm)	(dBm)	(dB)
50	12.82	18.69	25.03	40.23	1.23	0.51	36.57	17.30	4.44
100	12.79	18.64	25.30	38.49	1.23	0.51	36.42	17.26	4.46
200	12.75	18.67	25.52	36.49	1.24	0.51	36.66	17.36	4.55
300	12.72	18.68	25.56	34.88	1.24	0.50	36.50	17.42	4.55
400	12.67	18.68	25.77	32.90	1.24	0.50	35.97	17.57	4.52
500	12.63	18.68	25.99	31.20	1.25	0.50	35.78	17.60	4.57
600	12.59	18.67	26.35	29.76	1.25	0.50	35.64	17.67	4.58
700	12.54	18.68	26.76	28.56	1.26	0.49	35.47	17.77	4.57
800	12.50	18.69	27.20	27.38	1.26	0.49	35.67	17.77	4.60
900	12.45	18.70	27.66	26.42	1.27	0.49	35.68	17.89	4.56
1000	12.40	18.72	28.06	25.51	1.27	0.48	35.47	17.79	4.54
1100	12.35	18.73	28.71	24.76	1.28	0.48	35.27	17.76	4.60
1200	12.30	18.75	29.18	24.17	1.28	0.47	35.29	17.68	4.60
1300	12.25	18.77	29.94	23.61	1.29	0.47	35.28	17.59	4.61
1400	12.20	18.79	30.53	23.26	1.29	0.47	34.91	17.69	4.58
1500	12.15	18.80	31.30	22.86	1.30	0.46	35.03	17.65	4.62
1600	12.09	18.84	31.81	22.52	1.31	0.46	35.30	17.66	4.68
1700	12.04	18.87	32.59	22.30	1.32	0.45	35.99	17.70	4.61
1800	11.98	18.89	33.31	22.16	1.32	0.45	35.71	17.59	4.66
1900	11.92	18.92	33.87	22.04	1.33	0.45	35.19	17.58	4.61
2000	11.88	18.93	34.73	22.01	1.34	0.44	35.06	17.66	4.59
2100	11.81	19.00	35.16	21.84	1.35	0.44	34.50	17.58	4.57
2200	11.75	19.04	35.35	21.85	1.36	0.43	34.63	17.51	4.57
2300	11.69	19.06	35.20	21.94	1.37	0.43	34.19	17.39	4.63
2400	11.62	19.09	34.93	21.96	1.38	0.42	33.80	17.26	4.66
2500	11.56	19.14	34.75	22.03	1.40	0.42	33.67	17.21	4.64
2600	11.49	19.21	35.04	21.90	1.41	0.41	32.92	17.08	4.59
2700	11.43	19.21	33.58	22.13	1.42	0.41	32.99	16.96	4.68
2800	11.36	19.28	33.70	22.13	1.44	0.40	32.64	16.83	4.66
2900	11.30	19.32	32.53	22.20	1.45	0.40	32.85	16.70	4.62
3000	11.24	19.36	31.98	22.27	1.46	0.39	32.50	16.60	4.64
3100	11.14	19.46	32.27	22.01	1.49	0.38	31.88	16.39	4.70
3200	11.09	19.48	30.93	22.25	1.50	0.38	31.87	16.33	4.74
3300	11.03	19.52	30.06	22.39	1.51	0.38	31.77	16.28	4.71
3400	10.95	19.58	29.88	22.30	1.53	0.37	31.23	16.19	4.76
3500	10.85	19.71	30.35	21.88	1.56	0.36	31.15	16.11	4.81
3600	10.82	19.72	29.03	22.25	1.56	0.36	30.57	15.95	4.73
3700	10.74	19.77	28.99	22.23	1.58	0.36	30.19	15.80	4.71
3800	10.69	19.83	28.41	22.28	1.60	0.35	29.88	15.70	4.73
4000	10.52	19.93	29.07	22.15	1.64	0.34	29.21	15.49	4.86

REV. X1
ERA-6SM+
070816
Page 1 of 11



IF/RF MICROWAVE COMPONENTS • ISO 9001 ISO 14001 AS 9100 CERTIFIED • RoHS compliant
P.O. Box 350166, Brooklyn, New York 11235-0003 (718) 934-4500 Fax (718) 332-4661



The Design Engineers Search Engine finds the model you need, Instantly • For detailed performance specs & shopping online see



MMIC Amplifier

ERA-6SM+

Typical Performance Data

Definitions:

Input Return Loss = -S11 (dB)

Gain(Power Gain) = S21 (dB)

Reverse Isolation = -S12 (dB)

Output Return Loss = -S22 (dB)

TEST CONDITIONS: Icc = 56mA, Vd = 4.68V @Temperature = +25degC

FREQ	Gain	Isolation	Input Return Loss	Output Return Loss	Stability		IP3 Output	1dB Comp. Output	Noise Figure
					K	Delta			
(MHz)	(dB)	(dB)	(dB)	(dB)	K	Delta	(dBm)	(dBm)	(dB)
50	12.70	18.55	23.92	45.50	1.23	0.51	33.37	16.00	4.30
100	12.68	18.57	24.24	44.22	1.24	0.51	33.23	16.15	4.38
200	12.63	18.58	24.36	40.11	1.24	0.50	33.42	16.01	4.41
300	12.61	18.59	24.46	37.50	1.24	0.50	33.52	15.91	4.49
400	12.57	18.58	24.64	34.73	1.25	0.50	33.00	16.07	4.42
500	12.52	18.59	24.86	32.77	1.25	0.50	32.86	15.99	4.48
600	12.48	18.59	25.19	31.09	1.25	0.49	32.71	16.14	4.50
700	12.43	18.60	25.55	29.78	1.26	0.49	32.67	16.22	4.43
800	12.40	18.61	25.97	28.45	1.26	0.49	32.73	16.20	4.46
900	12.34	18.62	26.38	27.40	1.27	0.48	32.79	16.28	4.44
1000	12.30	18.64	26.76	26.39	1.27	0.48	32.61	16.12	4.41
1100	12.25	18.65	27.36	25.60	1.28	0.48	32.51	16.05	4.47
1200	12.20	18.67	27.80	24.97	1.28	0.47	32.52	15.91	4.46
1300	12.15	18.69	28.52	24.37	1.29	0.47	32.67	15.84	4.52
1400	12.10	18.70	29.03	23.99	1.30	0.47	32.31	15.97	4.51
1500	12.05	18.72	29.71	23.56	1.30	0.46	32.42	15.97	4.53
1600	11.99	18.76	30.21	23.20	1.31	0.46	32.83	15.97	4.54
1700	11.95	18.79	30.88	22.96	1.32	0.45	33.39	16.03	4.51
1800	11.89	18.82	31.48	22.80	1.33	0.45	33.33	15.94	4.56
1900	11.83	18.84	31.86	22.67	1.34	0.45	32.86	15.94	4.49
2000	11.79	18.87	32.47	22.65	1.34	0.44	32.95	16.06	4.48
2100	11.72	18.93	32.77	22.45	1.36	0.44	32.41	16.05	4.50
2200	11.66	18.97	32.80	22.43	1.37	0.43	32.66	16.07	4.45
2300	11.60	18.98	32.47	22.52	1.38	0.43	32.39	16.09	4.56
2400	11.54	19.02	32.21	22.53	1.39	0.42	32.15	16.09	4.52
2500	11.48	19.07	31.88	22.57	1.40	0.42	32.14	16.06	4.53
2600	11.40	19.15	32.11	22.44	1.42	0.41	31.44	16.01	4.49
2700	11.35	19.16	30.92	22.65	1.42	0.41	31.59	16.02	4.55
2800	11.28	19.21	30.92	22.62	1.44	0.40	31.21	15.92	4.55
2900	11.22	19.26	30.08	22.66	1.45	0.40	31.44	15.80	4.47
3000	11.16	19.30	29.57	22.74	1.47	0.39	31.08	15.75	4.57
3100	11.06	19.41	29.80	22.44	1.49	0.38	30.56	15.60	4.58
3200	11.01	19.44	28.73	22.66	1.50	0.38	30.53	15.49	4.62
3300	10.95	19.47	28.06	22.77	1.51	0.38	30.42	15.51	4.57
3400	10.87	19.53	27.88	22.67	1.53	0.37	30.00	15.39	4.62
3500	10.77	19.66	28.23	22.23	1.56	0.36	29.90	15.25	4.69
3600	10.74	19.68	27.16	22.57	1.57	0.36	29.34	15.13	4.59
3700	10.67	19.72	27.11	22.55	1.59	0.36	29.10	14.98	4.60
3800	10.61	19.79	26.60	22.57	1.60	0.35	28.74	14.89	4.62
4000	10.44	19.90	27.10	22.44	1.65	0.34	28.17	14.64	4.72

REV. X1

ERA-6SM+

070816

Page 2 of 11



IF/RF MICROWAVE COMPONENTS • ISO 9001 ISO 14001 AS 9100 CERTIFIED • RoHS compliant

P.O. Box 350166, Brooklyn, New York 11235-0003 (718) 934-4500 Fax (718) 332-4661



The Design Engineers Search Engine finds the model you need, Instantly • For detailed performance specs & shopping online see



MMIC Amplifier

ERA-6SM+

Typical Performance Data

Definitions:

Input Return Loss = -S11 (dB)

Gain(Power Gain) = S21 (dB)

Reverse Isolation = -S12 (dB)

Output Return Loss = -S22 (dB)

TEST CONDITIONS: I_{cc} = 84mA, V_d = 5.00V @Temperature = +25degC

FREQ	Gain	Isolation	Input Return Loss	Output Return Loss	Stability		IP3 Output	1dB Comp. Output	Noise Figure
					K	Delta			
(MHz)	(dB)	(dB)	(dB)	(dB)	K	Delta	(dBm)	(dBm)	(dB)
50	12.89	18.65	25.79	36.07	1.22	0.51	38.70	17.54	4.57
100	12.86	18.71	26.19	35.26	1.23	0.51	38.57	17.47	4.60
200	12.81	18.72	26.29	34.02	1.24	0.51	38.63	17.62	4.65
300	12.78	18.73	26.39	32.94	1.24	0.50	38.50	17.75	4.67
400	12.74	18.72	26.58	31.38	1.24	0.50	37.75	17.92	4.65
500	12.69	18.74	26.82	30.00	1.25	0.50	37.59	18.05	4.68
600	12.65	18.72	27.21	28.75	1.25	0.50	37.43	18.09	4.69
700	12.60	18.74	27.64	27.67	1.26	0.49	37.14	18.24	4.66
800	12.56	18.75	28.10	26.61	1.26	0.49	37.21	18.30	4.69
900	12.51	18.76	28.57	25.73	1.26	0.49	37.31	18.48	4.65
1000	12.47	18.77	29.01	24.90	1.27	0.48	36.98	18.56	4.67
1100	12.41	18.78	29.68	24.18	1.27	0.48	36.81	18.66	4.75
1200	12.36	18.79	30.15	23.65	1.28	0.47	36.80	18.68	4.72
1300	12.30	18.82	30.94	23.12	1.29	0.47	36.66	18.56	4.73
1400	12.26	18.83	31.55	22.78	1.29	0.47	36.31	18.68	4.70
1500	12.20	18.86	32.37	22.38	1.30	0.46	36.31	18.61	4.72
1600	12.15	18.89	32.82	22.06	1.31	0.46	36.58	18.55	4.78
1700	12.09	18.92	33.67	21.86	1.32	0.45	37.01	18.58	4.78
1800	12.04	18.94	34.42	21.71	1.32	0.45	36.72	18.47	4.78
1900	11.98	18.97	35.08	21.60	1.33	0.45	36.14	18.48	4.73
2000	11.93	18.98	36.17	21.58	1.34	0.44	35.93	18.47	4.73
2100	11.86	19.04	36.60	21.43	1.35	0.44	35.42	18.31	4.71
2200	11.80	19.09	36.98	21.44	1.36	0.43	35.47	18.16	4.69
2300	11.74	19.10	37.19	21.53	1.37	0.43	34.96	17.97	4.78
2400	11.67	19.13	37.12	21.57	1.38	0.42	34.64	17.81	4.76
2500	11.61	19.18	37.22	21.64	1.40	0.42	34.32	17.74	4.77
2600	11.53	19.25	37.55	21.53	1.41	0.41	33.73	17.56	4.72
2700	11.48	19.25	36.00	21.76	1.42	0.41	33.65	17.46	4.84
2800	11.41	19.31	36.21	21.76	1.43	0.40	33.22	17.33	4.75
2900	11.34	19.36	34.86	21.83	1.45	0.40	33.39	17.19	4.76
3000	11.29	19.39	34.20	21.93	1.46	0.39	33.11	17.10	4.82
3100	11.18	19.50	34.54	21.67	1.48	0.38	32.56	16.90	4.86
3200	11.13	19.51	32.88	21.93	1.49	0.38	32.51	16.84	4.87
3300	11.08	19.55	31.88	22.06	1.51	0.38	32.52	16.81	4.85
3400	11.00	19.61	31.72	21.98	1.52	0.37	31.91	16.72	4.92
3500	10.90	19.73	32.31	21.59	1.55	0.36	31.73	16.65	4.95
3600	10.86	19.74	30.70	21.97	1.56	0.36	31.18	16.50	4.90
3700	10.79	19.79	30.71	21.94	1.58	0.36	30.79	16.37	4.89
3800	10.74	19.84	30.00	22.01	1.59	0.35	30.45	16.26	4.86
4000	10.57	19.94	30.87	21.86	1.63	0.34	29.83	16.09	4.95

REV. X1
ERA-6SM+
070816
Page 3 of 11



IF/RF MICROWAVE COMPONENTS • ISO 9001 ISO 14001 AS 9100 CERTIFIED • RoHS compliant

P.O. Box 350166, Brooklyn, New York 11235-0003 (718) 934-4500 Fax (718) 332-4661



The Design Engineers Search Engine finds the model you need, Instantly • For detailed performance specs & shopping online see



MMIC Amplifier

ERA-6SM+

Typical Performance Data

Definitions:

Input Return Loss = -S11 (dB)

Gain(Power Gain) = S21 (dB)

Reverse Isolation = -S12 (dB)

Output Return Loss = -S22 (dB)

TEST CONDITIONS: I_{cc} = 70mA, V_d = 5.09V @Temperature = -45degC

FREQ	Gain	Isolation	Input Return Loss	Output Return Loss	Stability		IP3 Output	1dB Comp. Output	Noise Figure
					K	Delta			
(MHz)	(dB)	(dB)	(dB)	(dB)	K	Delta	(dBm)	(dBm)	(dB)
50	12.89	18.71	24.27	43.83	1.23	0.51	37.25	17.68	3.85
100	12.86	18.69	23.85	46.54	1.23	0.51	37.18	17.69	3.85
200	12.82	18.71	23.43	38.22	1.23	0.51	37.28	17.73	3.92
300	12.80	18.69	24.48	35.05	1.23	0.51	37.37	17.73	3.90
400	12.77	18.69	25.53	32.41	1.24	0.51	36.74	17.87	3.91
500	12.73	18.68	26.24	30.47	1.24	0.50	36.64	17.90	3.92
600	12.69	18.68	26.80	29.14	1.24	0.50	36.58	17.98	3.92
700	12.65	18.68	26.69	28.60	1.25	0.50	36.46	18.07	3.89
800	12.61	18.68	26.67	27.69	1.25	0.50	36.65	18.07	3.91
900	12.56	18.70	27.28	26.60	1.25	0.49	36.74	18.16	3.88
1000	12.52	18.71	27.63	25.57	1.26	0.49	36.66	18.03	3.84
1100	12.47	18.71	27.86	24.72	1.26	0.49	36.32	17.97	3.89
1200	12.42	18.73	28.40	24.12	1.27	0.48	36.59	17.88	3.93
1300	12.37	18.75	29.62	23.60	1.27	0.48	36.65	17.82	3.95
1400	12.32	18.75	30.26	23.25	1.28	0.48	36.28	17.92	3.89
1500	12.27	18.78	30.73	22.73	1.29	0.47	36.44	17.91	3.96
1600	12.22	18.80	31.36	22.22	1.29	0.47	36.78	17.95	3.97
1700	12.17	18.83	32.48	21.84	1.30	0.46	37.49	17.99	3.96
1800	12.12	18.85	33.46	21.67	1.31	0.46	37.27	17.88	3.96
1900	12.06	18.88	34.01	21.57	1.32	0.45	36.76	17.91	3.94
2000	12.01	18.88	35.09	21.54	1.32	0.45	36.65	17.99	3.92
2100	11.94	18.95	36.22	21.25	1.33	0.45	36.19	17.98	3.86
2200	11.89	18.98	37.49	21.16	1.34	0.44	36.41	17.96	3.87
2300	11.83	19.00	37.15	21.20	1.35	0.44	35.95	17.91	3.94
2400	11.76	19.03	36.86	21.24	1.36	0.43	35.67	17.85	3.98
2500	11.71	19.07	37.44	21.47	1.37	0.43	35.49	17.82	3.96
2600	11.62	19.15	37.04	21.42	1.39	0.42	34.75	17.69	3.92
2700	11.59	19.14	35.38	21.77	1.39	0.42	34.85	17.64	3.96
2800	11.51	19.18	36.00	21.74	1.41	0.41	34.32	17.51	3.92
2900	11.45	19.23	35.31	21.66	1.42	0.41	34.64	17.38	3.94
3000	11.39	19.26	34.33	21.71	1.43	0.40	34.30	17.30	3.96
3100	11.31	19.33	34.69	21.79	1.45	0.40	33.72	17.06	4.01
3200	11.24	19.39	34.40	21.98	1.46	0.39	33.56	17.06	4.03
3300	11.18	19.42	34.19	22.07	1.48	0.39	33.61	17.02	3.96
3400	11.12	19.44	34.03	22.08	1.49	0.38	33.00	16.91	4.09
3500	11.01	19.59	35.14	21.52	1.52	0.37	32.87	16.85	4.04
3600	10.98	19.58	32.38	22.06	1.52	0.37	32.32	16.70	4.01
3700	10.91	19.64	32.24	22.11	1.54	0.37	31.89	16.51	3.98
3800	10.86	19.69	31.86	22.35	1.56	0.36	31.57	16.39	4.02
4000	10.72	19.75	32.23	22.22	1.58	0.36	30.92	16.17	4.10

REV. X1
ERA-6SM+
070816
Page 4 of 11



IF/RF MICROWAVE COMPONENTS • ISO 9001 ISO 14001 AS 9100 CERTIFIED • RoHS compliant
P.O. Box 350166, Brooklyn, New York 11235-0003 (718) 934-4500 Fax (718) 332-4661



The Design Engineers Search Engine finds the model you need, Instantly • For detailed performance specs & shopping online see



MMIC Amplifier

ERA-6SM+

Typical Performance Data

Definitions:

Input Return Loss = -S11 (dB)

Gain(Power Gain) = S21 (dB)

Reverse Isolation = -S12 (dB)

Output Return Loss = -S22 (dB)

TEST CONDITIONS: Icc = 56mA, Vd =4.92V @Temperature = -45degC

FREQ	Gain	Isolation	Input Return Loss	Output Return Loss	Stability		IP3 Output	1dB Comp. Output	Noise Figure
					K	Delta			
(MHz)	(dB)	(dB)	(dB)	(dB)	K	Delta	(dBm)	(dBm)	(dB)
50	12.79	18.59	23.45	45.84	1.23	0.51	33.98	16.12	3.75
100	12.76	18.61	23.08	42.22	1.23	0.51	33.87	16.27	3.78
200	12.73	18.62	22.65	36.43	1.23	0.51	34.07	16.09	3.80
300	12.71	18.62	23.61	36.07	1.24	0.51	34.19	16.00	3.80
400	12.68	18.62	24.58	34.09	1.24	0.50	33.69	16.20	3.81
500	12.64	18.61	25.23	31.94	1.24	0.50	33.61	16.14	3.79
600	12.60	18.61	25.74	30.50	1.24	0.50	33.47	16.31	3.82
700	12.56	18.61	25.64	29.77	1.25	0.50	33.45	16.35	3.82
800	12.52	18.62	25.66	28.66	1.25	0.49	33.56	16.40	3.82
900	12.48	18.63	26.24	27.46	1.26	0.49	33.67	16.48	3.78
1000	12.43	18.63	26.55	26.31	1.26	0.49	33.53	16.28	3.77
1100	12.38	18.64	26.76	25.40	1.26	0.49	33.39	16.20	3.82
1200	12.33	18.66	27.34	24.79	1.27	0.48	33.42	16.04	3.83
1300	12.29	18.68	28.53	24.27	1.28	0.48	33.62	15.97	3.85
1400	12.24	18.69	29.08	23.89	1.28	0.47	33.30	16.11	3.80
1500	12.19	18.71	29.55	23.31	1.29	0.47	33.50	16.08	3.84
1600	12.14	18.74	30.18	22.77	1.29	0.47	33.89	16.14	3.86
1700	12.09	18.76	31.24	22.39	1.30	0.46	34.51	16.22	3.89
1800	12.04	18.79	32.17	22.22	1.31	0.46	34.41	16.11	3.87
1900	11.98	18.81	32.70	22.10	1.32	0.45	34.05	16.13	3.82
2000	11.94	18.82	33.60	22.05	1.32	0.45	34.07	16.25	3.80
2100	11.87	18.88	34.70	21.75	1.34	0.44	33.61	16.28	3.77
2200	11.81	18.91	35.36	21.65	1.34	0.44	34.01	16.39	3.81
2300	11.76	18.93	34.66	21.68	1.35	0.44	33.65	16.43	3.83
2400	11.69	18.97	34.47	21.74	1.36	0.43	33.58	16.51	3.88
2500	11.63	19.01	34.55	21.96	1.37	0.43	33.61	16.55	3.88
2600	11.56	19.09	34.40	21.87	1.39	0.42	32.91	16.49	3.81
2700	11.52	19.08	32.82	22.22	1.40	0.42	33.07	16.50	3.86
2800	11.44	19.14	33.22	22.19	1.41	0.41	32.70	16.44	3.84
2900	11.38	19.18	32.49	22.08	1.42	0.41	33.03	16.40	3.81
3000	11.32	19.21	31.70	22.13	1.43	0.40	32.67	16.36	3.84
3100	11.24	19.28	31.97	22.19	1.45	0.40	32.15	16.15	3.87
3200	11.17	19.34	31.83	22.36	1.47	0.39	32.23	16.13	3.89
3300	11.11	19.38	31.53	22.44	1.48	0.39	32.03	16.12	3.89
3400	11.05	19.40	31.32	22.45	1.49	0.38	31.60	16.01	3.96
3500	10.94	19.55	32.06	21.85	1.52	0.37	31.54	15.94	3.95
3600	10.92	19.55	30.00	22.40	1.53	0.37	31.06	15.82	3.93
3700	10.84	19.60	29.81	22.44	1.55	0.37	30.66	15.66	3.91
3800	10.79	19.67	29.57	22.66	1.56	0.36	30.25	15.54	3.88
4000	10.66	19.73	29.75	22.52	1.59	0.35	29.63	15.37	3.93

REV. X1
ERA-6SM+
070816

Page 5 of 11



IF/RF MICROWAVE COMPONENTS • ISO 9001 ISO 14001 AS 9100 CERTIFIED • RoHS compliant

P.O. Box 350166, Brooklyn, New York 11235-0003 (718) 934-4500 Fax (718) 332-4661



The Design Engineers Search Engine finds the model you need, Instantly • For detailed performance specs & shopping online see



MMIC Amplifier

ERA-6SM+

Typical Performance Data

Definitions:

Input Return Loss = -S11 (dB)

Gain(Power Gain) = S21 (dB)

Reverse Isolation = -S12 (dB)

Output Return Loss = -S22 (dB)

TEST CONDITIONS: I_{cc} = 84mA, V_d = 5.25V @Temperature = -45degC

FREQ	Gain	Isolation	Input Return Loss	Output Return Loss	Stability		IP3 Output	1dB Comp. Output	Noise Figure
					K	Delta			
(MHz)	(dB)	(dB)	(dB)	(dB)	K	Delta	(dBm)	(dBm)	(dB)
50	12.95	18.74	24.88	38.47	1.23	0.51	39.35	17.99	3.92
100	12.92	18.73	24.41	41.37	1.23	0.51	39.25	17.93	3.96
200	12.88	18.74	23.98	37.62	1.23	0.51	39.46	18.08	4.01
300	12.86	18.73	25.08	33.58	1.23	0.51	39.31	18.19	4.01
400	12.83	18.73	26.24	31.15	1.24	0.51	38.75	18.34	4.00
500	12.79	18.74	26.99	29.43	1.24	0.50	38.72	18.48	4.03
600	12.75	18.72	27.59	28.26	1.24	0.50	38.58	18.54	4.03
700	12.71	18.73	27.43	27.77	1.25	0.50	38.46	18.70	3.97
800	12.66	18.73	27.42	26.97	1.25	0.50	38.60	18.79	4.03
900	12.62	18.74	28.05	25.97	1.25	0.49	38.66	18.94	3.99
1000	12.57	18.75	28.41	25.00	1.26	0.49	38.49	18.99	3.98
1100	12.52	18.75	28.63	24.23	1.26	0.49	38.26	19.06	4.01
1200	12.48	18.77	29.14	23.65	1.27	0.48	38.20	19.00	4.03
1300	12.42	18.79	30.37	23.13	1.27	0.48	38.35	18.92	4.04
1400	12.38	18.80	31.03	22.81	1.28	0.48	38.02	19.03	4.01
1500	12.32	18.81	31.51	22.31	1.28	0.47	38.06	18.97	4.04
1600	12.27	18.84	32.07	21.83	1.29	0.47	38.36	18.98	4.07
1700	12.21	18.87	33.17	21.46	1.30	0.46	39.06	19.04	4.08
1800	12.16	18.89	34.07	21.30	1.30	0.46	38.74	18.90	4.09
1900	12.10	18.92	34.63	21.20	1.31	0.45	38.24	18.95	4.03
2000	12.06	18.92	35.60	21.16	1.32	0.45	38.06	19.00	4.01
2100	11.99	18.99	36.56	20.90	1.33	0.45	37.56	18.89	3.99
2200	11.93	19.01	38.18	20.82	1.34	0.44	37.73	18.76	4.02
2300	11.88	19.03	38.57	20.86	1.35	0.44	37.11	18.59	4.05
2400	11.81	19.06	38.24	20.90	1.36	0.43	36.81	18.49	4.07
2500	11.75	19.10	39.31	21.12	1.37	0.43	36.46	18.40	4.06
2600	11.67	19.18	38.52	21.09	1.39	0.42	35.81	18.22	4.03
2700	11.63	19.17	37.39	21.43	1.39	0.42	35.76	18.15	4.11
2800	11.55	19.22	38.15	21.42	1.41	0.41	35.30	18.02	4.04
2900	11.49	19.26	37.96	21.34	1.42	0.41	35.55	17.88	4.06
3000	11.43	19.28	36.94	21.40	1.43	0.40	35.18	17.79	4.07
3100	11.35	19.35	37.21	21.47	1.45	0.40	34.67	17.58	4.11
3200	11.28	19.41	36.74	21.66	1.46	0.39	34.62	17.55	4.11
3300	11.22	19.44	36.76	21.77	1.47	0.39	34.57	17.54	4.11
3400	11.16	19.47	36.98	21.77	1.49	0.38	33.98	17.40	4.16
3500	11.05	19.61	38.44	21.22	1.52	0.37	33.93	17.39	4.20
3600	11.02	19.60	34.82	21.77	1.52	0.37	33.19	17.26	4.15
3700	10.95	19.66	34.60	21.82	1.54	0.37	32.66	17.10	4.13
3800	10.89	19.72	34.16	22.08	1.55	0.36	32.40	17.00	4.15
4000	10.76	19.77	34.81	21.96	1.58	0.36	31.53	16.79	4.22

REV. X1
ERA-6SM+
070816
Page 6 of 11



IF/RF MICROWAVE COMPONENTS • ISO 9001 ISO 14001 AS 9100 CERTIFIED • RoHS compliant
P.O. Box 350166, Brooklyn, New York 11235-0003 (718) 934-4500 Fax (718) 332-4661



The Design Engineers Search Engine finds the model you need, Instantly • For detailed performance specs & shopping online see



MMIC Amplifier

ERA-6SM+

Typical Performance Data

Definitions:

Input Return Loss = -S11 (dB)

Gain(Power Gain) = S21 (dB)

Reverse Isolation = -S12 (dB)

Output Return Loss = -S22 (dB)

TEST CONDITIONS: Icc = 70mA, Vd = 4.66V @Temperature = +85degC

FREQ	Gain	Isolation	Input Return Loss	Output Return Loss	Stability		IP3 Output	1dB Comp. Output	Noise Figure
					K	Delta			
(MHz)	(dB)	(dB)	(dB)	(dB)	K	Delta	(dBm)	(dBm)	(dB)
50	12.75	18.65	25.42	38.93	1.24	0.51	35.99	16.77	4.86
100	12.72	18.64	26.57	35.27	1.24	0.50	35.89	16.72	4.91
200	12.67	18.65	27.97	32.37	1.24	0.50	36.17	16.83	4.98
300	12.64	18.66	27.35	33.29	1.25	0.50	36.01	16.93	4.96
400	12.59	18.66	26.38	33.63	1.25	0.50	35.37	17.08	5.00
500	12.55	18.67	26.01	32.19	1.26	0.49	35.09	17.16	5.05
600	12.50	18.67	26.22	30.69	1.26	0.49	34.91	17.20	5.04
700	12.45	18.68	26.45	29.52	1.26	0.49	34.75	17.32	5.04
800	12.41	18.69	26.53	28.40	1.27	0.48	34.76	17.34	5.07
900	12.35	18.71	26.53	27.39	1.27	0.48	34.80	17.46	5.01
1000	12.31	18.72	26.69	26.27	1.28	0.48	34.54	17.38	5.03
1100	12.25	18.73	27.15	25.40	1.28	0.47	34.28	17.35	5.07
1200	12.20	18.75	27.63	24.65	1.29	0.47	34.27	17.28	5.10
1300	12.14	18.78	28.47	23.93	1.30	0.46	34.18	17.18	5.11
1400	12.10	18.79	29.38	23.44	1.30	0.46	33.79	17.29	5.06
1500	12.04	18.82	30.55	22.97	1.31	0.46	33.89	17.22	5.16
1600	11.98	18.86	31.35	22.56	1.32	0.45	34.25	17.18	5.20
1700	11.93	18.88	32.68	22.24	1.33	0.45	34.67	17.21	5.12
1800	11.88	18.91	33.95	22.06	1.34	0.44	34.29	17.13	5.15
1900	11.81	18.94	35.05	21.97	1.35	0.44	33.78	17.11	5.12
2000	11.76	18.97	36.31	21.98	1.36	0.44	33.72	17.14	5.12
2100	11.70	19.02	36.61	21.92	1.37	0.43	33.20	17.01	5.09
2200	11.64	19.06	36.17	22.09	1.38	0.42	33.21	16.88	5.11
2300	11.58	19.09	35.09	22.35	1.39	0.42	32.74	16.73	5.13
2400	11.51	19.13	34.04	22.49	1.40	0.42	32.37	16.60	5.18
2500	11.45	19.17	32.75	22.69	1.42	0.41	32.16	16.52	5.20
2600	11.37	19.25	32.27	22.67	1.43	0.40	31.50	16.35	5.15
2700	11.32	19.26	30.86	22.91	1.44	0.40	31.49	16.27	5.21
2800	11.23	19.34	30.49	22.87	1.46	0.39	31.13	16.15	5.16
2900	11.18	19.37	29.55	22.94	1.47	0.39	31.26	16.00	5.16
3000	11.11	19.42	29.03	22.89	1.49	0.39	30.93	15.89	5.23
3100	11.02	19.51	29.14	22.57	1.51	0.38	30.41	15.66	5.19
3200	10.96	19.55	28.04	22.62	1.52	0.37	30.33	15.59	5.24
3300	10.90	19.59	27.60	22.55	1.54	0.37	30.24	15.57	5.26
3400	10.83	19.64	27.39	22.48	1.55	0.36	29.69	15.42	5.33
3500	10.73	19.77	27.39	22.06	1.58	0.36	29.58	15.34	5.34
3600	10.68	19.80	26.79	22.21	1.60	0.35	29.00	15.19	5.29
3700	10.60	19.87	26.73	22.13	1.62	0.35	28.69	14.96	5.30
3800	10.54	19.92	26.37	22.23	1.63	0.34	28.40	14.88	5.43
4000	10.38	20.05	26.42	22.12	1.68	0.33	27.88	14.66	5.38

REV. X1
ERA-6SM+
070816

Page 7 of 11



IF/RF MICROWAVE COMPONENTS • ISO 9001 ISO 14001 AS 9100 CERTIFIED • RoHS compliant

P.O. Box 350166, Brooklyn, New York 11235-0003 (718) 934-4500 Fax (718) 332-4661



The Design Engineers Search Engine finds the model you need, Instantly • For detailed performance specs & shopping online see



MMIC Amplifier

ERA-6SM+

Typical Performance Data

Definitions:

Input Return Loss = -S11 (dB)

Gain(Power Gain) = S21 (dB)

Reverse Isolation = -S12 (dB)

Output Return Loss = -S22 (dB)

TEST CONDITIONS: Icc = 56mA, Vd = 4.50V @Temperature = +85degC

FREQ	Gain	Isolation	Input Return Loss	Output Return Loss	Stability		IP3 Output	1dB Comp. Output	Noise Figure
					K	Delta			
(MHz)	(dB)	(dB)	(dB)	(dB)	K	Delta	(dBm)	(dBm)	(dB)
50	12.62	18.55	24.19	43.42	1.24	0.51	32.96	15.81	4.76
100	12.59	18.53	25.15	40.32	1.24	0.50	32.82	15.90	4.82
200	12.55	18.55	26.37	36.49	1.24	0.50	33.04	15.84	4.88
300	12.52	18.57	25.84	37.55	1.25	0.50	33.15	15.77	4.89
400	12.48	18.57	25.04	36.32	1.25	0.50	32.54	15.91	4.88
500	12.43	18.59	24.75	33.98	1.26	0.49	32.34	15.80	4.94
600	12.38	18.58	24.94	32.12	1.26	0.49	32.17	15.92	4.96
700	12.33	18.59	25.15	30.82	1.27	0.49	32.14	16.00	4.96
800	12.29	18.61	25.27	29.47	1.27	0.48	32.16	15.95	4.96
900	12.24	18.61	25.27	28.27	1.28	0.48	32.18	16.01	4.93
1000	12.19	18.63	25.43	27.07	1.28	0.48	32.04	15.87	4.91
1100	12.14	18.64	25.87	26.14	1.29	0.47	31.83	15.79	4.98
1200	12.09	18.66	26.31	25.39	1.29	0.47	31.84	15.69	4.97
1300	12.03	18.69	27.10	24.65	1.30	0.46	31.90	15.60	4.99
1400	11.99	18.71	27.89	24.19	1.31	0.46	31.53	15.71	4.97
1500	11.93	18.73	28.90	23.72	1.31	0.46	31.65	15.72	5.02
1600	11.87	18.77	29.65	23.28	1.32	0.45	32.05	15.69	5.10
1700	11.82	18.80	30.73	22.97	1.33	0.45	32.57	15.75	5.02
1800	11.77	18.83	31.70	22.79	1.34	0.44	32.37	15.67	5.07
1900	11.71	18.86	32.36	22.69	1.35	0.44	31.90	15.65	5.00
2000	11.67	18.88	33.14	22.70	1.36	0.44	31.89	15.74	5.00
2100	11.60	18.94	33.22	22.64	1.37	0.43	31.37	15.70	4.97
2200	11.54	18.99	32.79	22.82	1.38	0.42	31.54	15.70	4.99
2300	11.48	19.01	31.91	23.06	1.39	0.42	31.22	15.66	5.00
2400	11.41	19.06	31.12	23.18	1.41	0.41	30.97	15.61	5.02
2500	11.35	19.11	30.11	23.37	1.42	0.41	30.89	15.55	5.05
2600	11.27	19.18	29.75	23.29	1.44	0.40	30.24	15.43	5.01
2700	11.22	19.20	28.67	23.50	1.45	0.40	30.30	15.44	5.10
2800	11.14	19.28	28.38	23.42	1.47	0.39	30.02	15.32	5.03
2900	11.08	19.31	27.64	23.45	1.48	0.39	30.10	15.19	4.99
3000	11.02	19.36	27.18	23.35	1.49	0.38	29.83	15.11	5.07
3100	10.92	19.45	27.26	23.01	1.51	0.38	29.25	14.91	5.10
3200	10.87	19.49	26.37	23.00	1.53	0.37	29.29	14.79	5.18
3300	10.80	19.54	26.00	22.91	1.54	0.37	29.14	14.80	5.11
3400	10.74	19.59	25.80	22.85	1.56	0.36	28.69	14.70	5.17
3500	10.64	19.72	25.77	22.39	1.59	0.35	28.58	14.54	5.19
3600	10.59	19.75	25.24	22.52	1.60	0.35	28.03	14.38	5.13
3700	10.51	19.83	25.22	22.45	1.62	0.35	27.78	14.18	5.17
3800	10.45	19.88	24.89	22.53	1.64	0.34	27.49	14.12	5.21
4000	10.29	20.01	24.90	22.42	1.68	0.33	27.02	13.82	5.27

REV. X1

ERA-6SM+

070816

Page 8 of 11



IF/RF MICROWAVE COMPONENTS • ISO 9001 ISO 14001 AS 9100 CERTIFIED • RoHS compliant

P.O. Box 350166, Brooklyn, New York 11235-0003 (718) 934-4500 Fax (718) 332-4661



The Design Engineers Search Engine finds the model you need, Instantly • For detailed performance specs & shopping online see



MMIC Amplifier

ERA-6SM+

Typical Performance Data

Definitions:

Input Return Loss = -S11 (dB)

Gain(Power Gain) = S21 (dB)

Reverse Isolation = -S12 (dB)

Output Return Loss = -S22 (dB)

TEST CONDITIONS: Icc = 84mA, Vd = 4.82V @Temperature = +85degC

FREQ	Gain	Isolation	Input Return Loss	Output Return Loss	Stability		IP3 Output	1dB Comp. Output	Noise Figure
					K	Delta			
(MHz)	(dB)	(dB)	(dB)	(dB)	K	Delta	(dBm)	(dBm)	(dB)
50	12.82	18.70	26.28	35.49	1.23	0.51	38.33	17.01	5.01
100	12.79	18.68	27.57	32.57	1.24	0.51	38.26	16.93	5.03
200	12.74	18.72	29.13	30.37	1.24	0.50	38.32	17.07	5.13
300	12.71	18.73	28.45	31.11	1.25	0.50	38.08	17.20	5.11
400	12.66	18.72	27.34	31.67	1.25	0.50	37.31	17.40	5.11
500	12.61	18.73	26.93	30.78	1.25	0.49	36.98	17.54	5.15
600	12.57	18.72	27.17	29.47	1.26	0.49	36.84	17.57	5.20
700	12.52	18.74	27.38	28.49	1.26	0.49	36.50	17.75	5.16
800	12.47	18.75	27.46	27.53	1.27	0.48	36.31	17.81	5.14
900	12.42	18.76	27.46	26.65	1.27	0.48	36.34	18.00	5.14
1000	12.37	18.78	27.57	25.63	1.28	0.48	35.95	18.08	5.16
1100	12.32	18.78	28.09	24.79	1.28	0.47	35.71	18.18	5.18
1200	12.26	18.81	28.54	24.09	1.29	0.47	35.60	18.20	5.20
1300	12.20	18.83	29.43	23.39	1.30	0.46	35.37	18.05	5.23
1400	12.16	18.85	30.41	22.91	1.30	0.46	34.98	18.18	5.24
1500	12.10	18.88	31.64	22.42	1.31	0.46	35.05	18.06	5.24
1600	12.04	18.91	32.48	22.05	1.32	0.45	35.34	17.99	5.31
1700	11.99	18.94	33.93	21.75	1.33	0.45	35.53	18.01	5.26
1800	11.93	18.96	35.37	21.56	1.34	0.44	34.96	17.91	5.29
1900	11.87	19.00	36.75	21.46	1.35	0.44	34.53	17.90	5.22
2000	11.82	19.01	38.66	21.48	1.35	0.44	34.21	17.86	5.22
2100	11.75	19.08	39.19	21.43	1.37	0.43	33.86	17.69	5.27
2200	11.69	19.11	39.11	21.61	1.38	0.42	33.75	17.48	5.24
2300	11.63	19.14	37.96	21.85	1.39	0.42	33.16	17.33	5.33
2400	11.56	19.18	36.62	21.99	1.40	0.42	32.88	17.17	5.32
2500	11.50	19.21	35.00	22.19	1.41	0.41	32.57	17.08	5.34
2600	11.42	19.29	34.32	22.18	1.43	0.40	31.97	16.90	5.30
2700	11.37	19.31	32.68	22.44	1.44	0.40	31.90	16.81	5.34
2800	11.29	19.38	32.19	22.42	1.46	0.39	31.50	16.70	5.31
2900	11.23	19.42	31.12	22.51	1.47	0.39	31.60	16.55	5.35
3000	11.16	19.46	30.50	22.46	1.48	0.39	31.25	16.42	5.37
3100	11.07	19.55	30.63	22.17	1.51	0.38	30.68	16.20	5.33
3200	11.02	19.58	29.35	22.24	1.52	0.37	30.62	16.14	5.43
3300	10.95	19.63	28.87	22.18	1.53	0.37	30.53	16.12	5.43
3400	10.88	19.67	28.67	22.12	1.55	0.37	29.95	16.00	5.49
3500	10.78	19.80	28.66	21.72	1.58	0.36	29.86	15.94	5.49
3600	10.73	19.83	27.96	21.87	1.59	0.35	29.32	15.77	5.45
3700	10.65	19.89	27.92	21.80	1.61	0.35	28.94	15.59	5.51
3800	10.59	19.94	27.48	21.89	1.63	0.34	28.65	15.47	5.55
4000	10.44	20.07	27.57	21.77	1.67	0.33	28.16	15.35	5.55

REV. X1
ERA-6SM+
070816
Page 9 of 11



IF/RF MICROWAVE COMPONENTS • ISO 9001 ISO 14001 AS 9100 CERTIFIED • RoHS compliant
P.O. Box 350166, Brooklyn, New York 11235-0003 (718) 934-4500 Fax (718) 332-4661



The Design Engineers Search Engine finds the model you need, Instantly • For detailed performance specs & shopping online see



Typical Performance Curves

GAIN vs. TEMPERATURE

INPUT POWER = -15dBm, CURRENT = 70mA

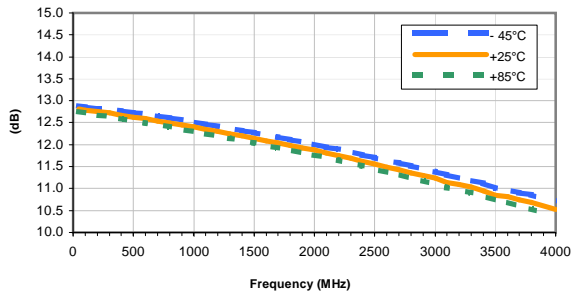

GAIN vs. CURRENT

INPUT POWER = -15dBm, Temperature = +25°C

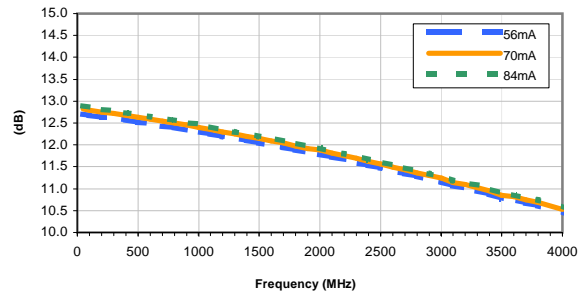

ISOLATION vs. TEMPERATURE

INPUT POWER = -15dBm, CURRENT = 70mA

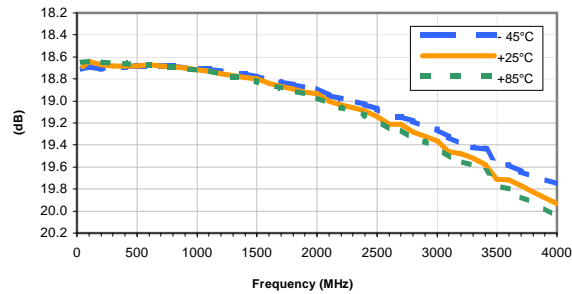

ISOLATION vs. CURRENT

INPUT POWER = -15dBm, Temperature = +25°C

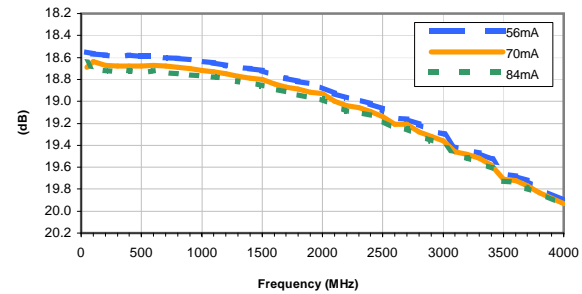

INPUT RETURN LOSS vs. TEMPERATURE

INPUT POWER = -15dBm, CURRENT = 70mA

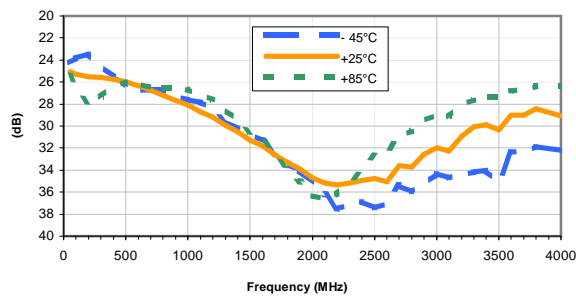

INPUT RETURN LOSS vs. CURRENT

INPUT POWER = -15dBm, Temperature = +25°C

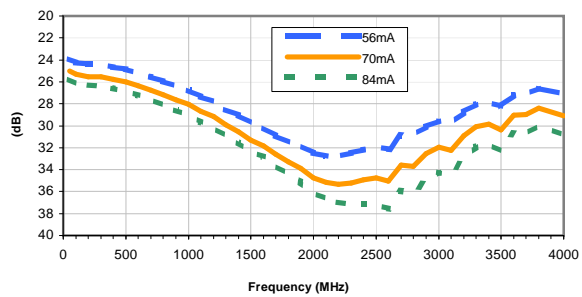

OUTPUT RETURN LOSS vs. TEMPERATURE

INPUT POWER = -15dBm, CURRENT = 70mA

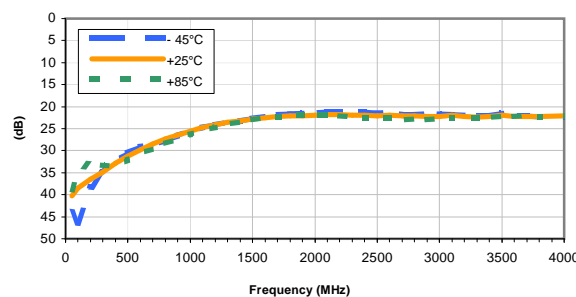

OUTPUT RETURN LOSS vs. CURRENT

INPUT POWER = -15dBm, Temperature = +25°C

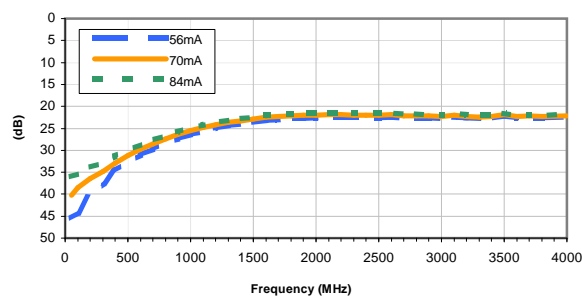

Typical Performance Curves

OUTPUT IP3 vs. TEMPERATURE

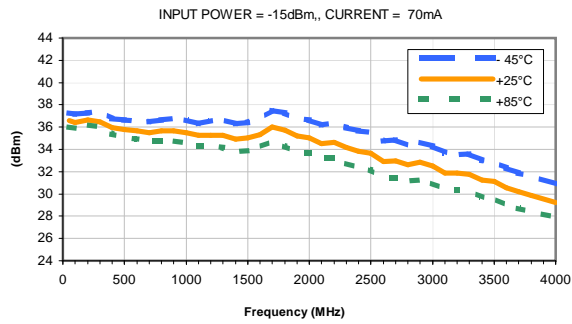

OUTPUT IP3 vs. CURRENT

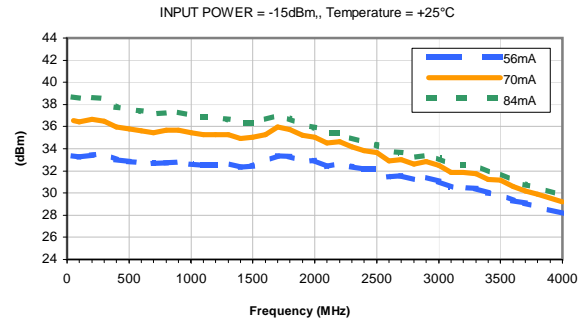

OUTPUT POWER at 1dB Compression vs. TEMPERATURE

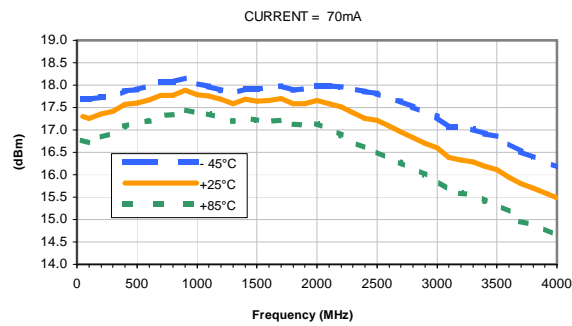

OUTPUT POWER at 1dB Compression vs. CURRENT

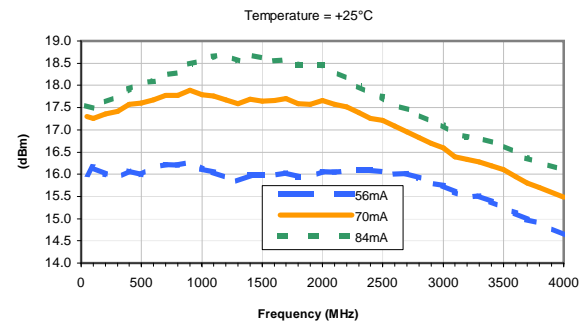

Noise Figure vs. TEMPERATURE

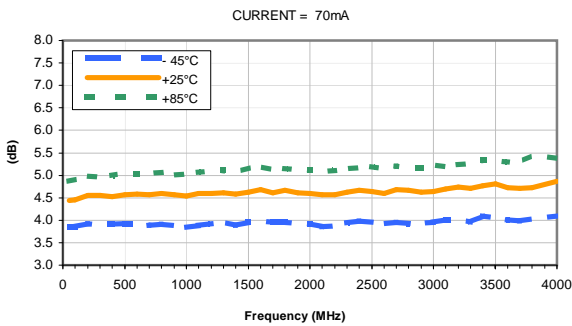

Noise Figure vs. CURRENT

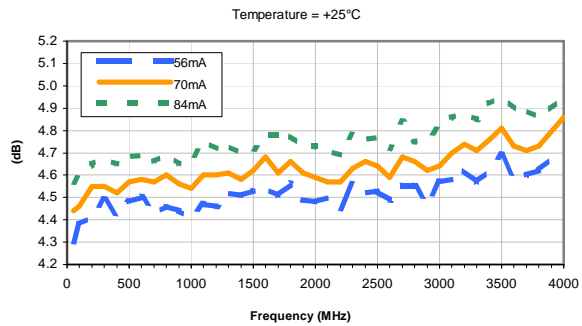

Typical Performance Curves

GAIN vs. TEMPERATURE

INPUT POWER = -15dBm, CURRENT = 70mA

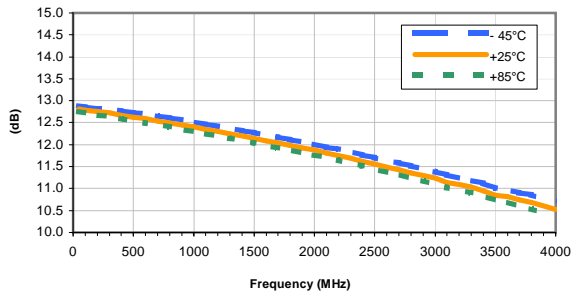

GAIN vs. CURRENT

INPUT POWER = -15dBm, Temperature = +25°C

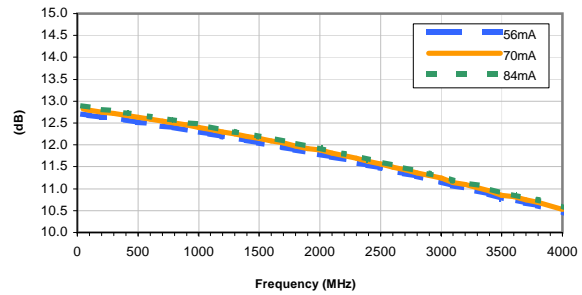

ISOLATION vs. TEMPERATURE

INPUT POWER = -15dBm, CURRENT = 70mA

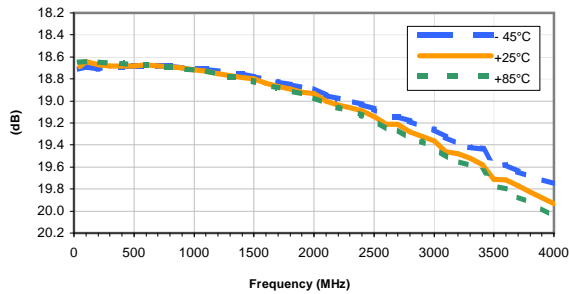

ISOLATION vs. CURRENT

INPUT POWER = -15dBm, Temperature = +25°C

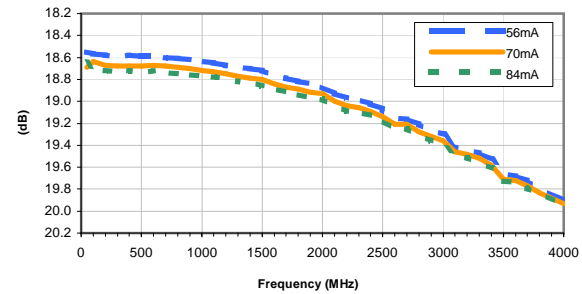

INPUT RETURN LOSS vs. TEMPERATURE

INPUT POWER = -15dBm, CURRENT = 70mA

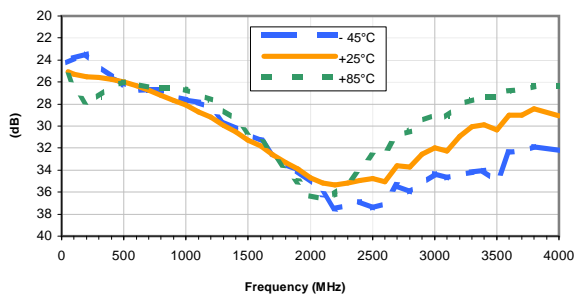

INPUT RETURN LOSS vs. CURRENT

INPUT POWER = -15dBm, Temperature = +25°C

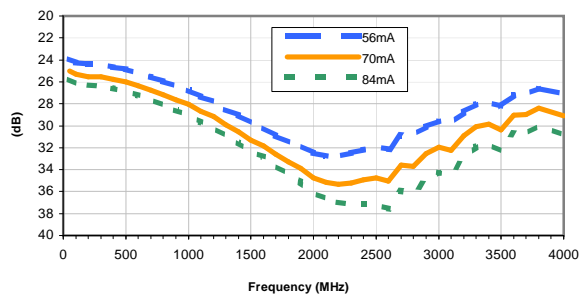

OUTPUT RETURN LOSS vs. TEMPERATURE

INPUT POWER = -15dBm, CURRENT = 70mA

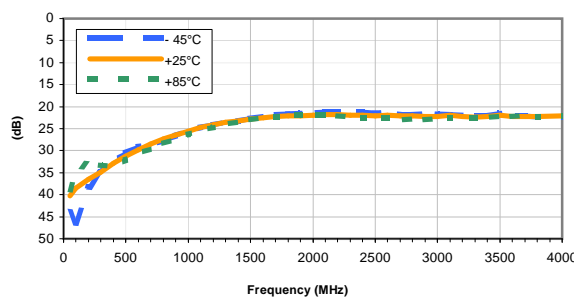

OUTPUT RETURN LOSS vs. CURRENT

INPUT POWER = -15dBm, Temperature = +25°C

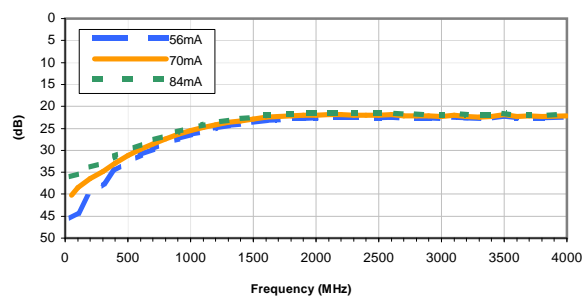

Typical Performance Curves

OUTPUT IP3 vs. TEMPERATURE

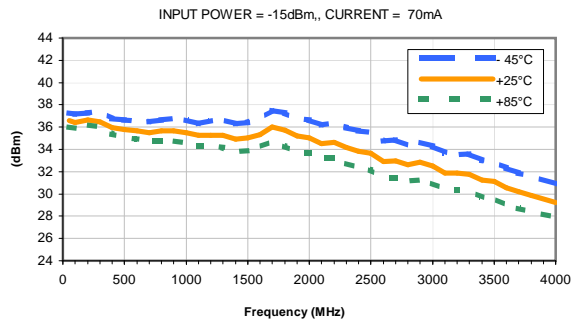

OUTPUT IP3 vs. CURRENT

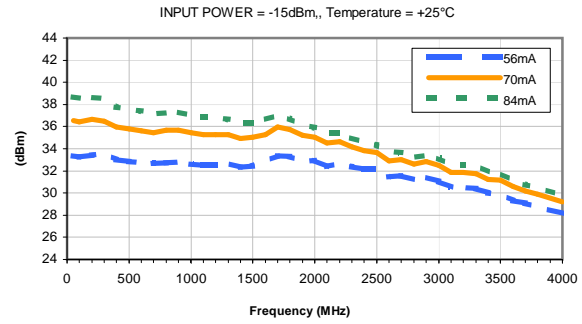

OUTPUT POWER at 1dB Compression vs. TEMPERATURE

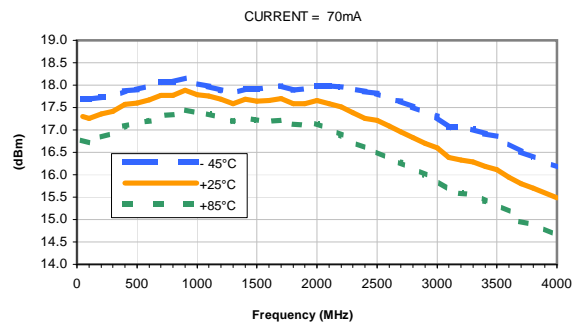

OUTPUT POWER at 1dB Compression vs. CURRENT

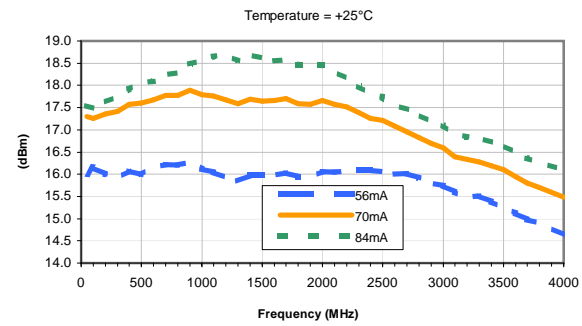

Noise Figure vs. TEMPERATURE

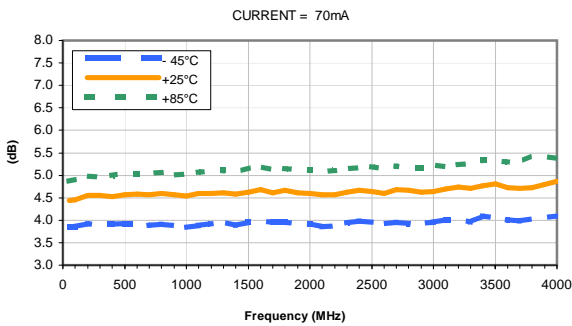

Noise Figure vs. CURRENT

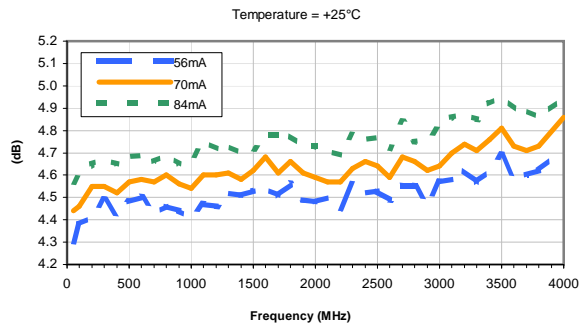

Outline Dimensions

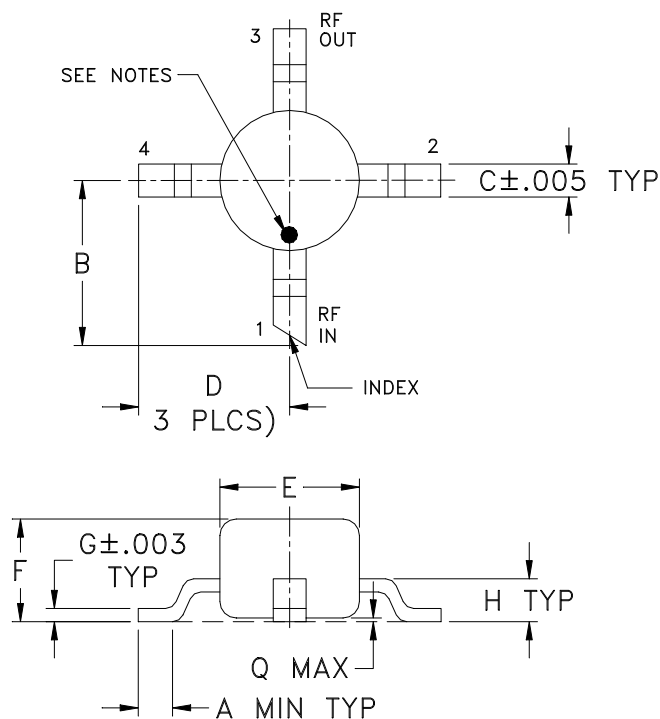

PCB Land Pattern

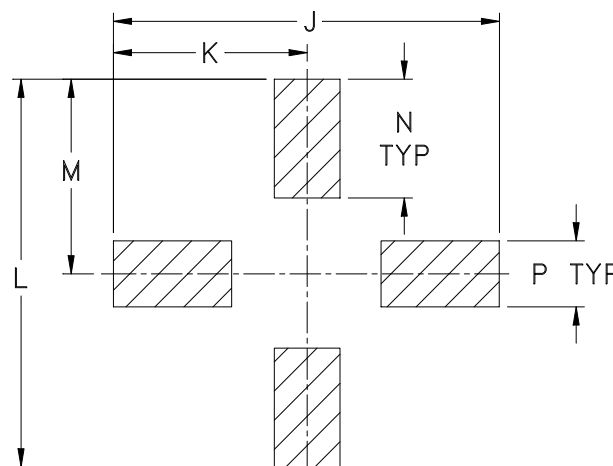

Suggested Layout,
Tolerance to be within $\pm .002$

CASE#	A	B	C	D	E	F	G	H	J	K	L	M	N	P	Q	WT. GRAMS
WW107	.012 (0.30)	.10 (2.54)	.020 (0.51)	.092 (2.34)	.085 (2.16)	.060 (1.52)	.007 (0.18)	.026 (0.66)	.235 (5.97)	.118 (3.00)	.235 (5.97)	.118 (3.00)	.072 (1.83)	.040 (1.02)	.020 (0.51)	.015

Dimensions are in inches (mm). Tolerances: 2 Pl. $\pm .03$; 3 Pl. $\pm .015$

Notes:

- Case material: Plastic.
- Termination finish:
For RoHS Case Styles: Matte tin Plate.
For RoHS-5 Case Styles: Tin-Lead plate.
- RF input termination (1) identified by one or both of the following at factory option:
 - diagonally cut termination, which may be 45° (ref) in either direction;
 - orientation mark on the case. Model dash number is identified by color dot or alphanumeric code on case. See specification data sheet.



INTERNET <http://www.minicircuits.com>

P.O. Box 350166, Brooklyn, New York 11235-0003 (718) 934-4500

Distribution Centers NORTH AMERICA 800-654-7949 • 417-335-5935 • Fax 417-335-5945 • EUROPE 44-1252-1

Mini-Circuits ISO 9001 & ISO 14001 Certified

Tape & Reel Packaging TR-F4

DEVICE ORIENTATION IN T&R



Tape Width, mm	Device Cavity Pitch, mm	Reel Size, inches	Devices per Reel	
12	8	7	Small quantity standards (see note)	20
				50
				100
				200
				500
		7	Standard	1000

Note: Please Consult individual model data sheet to determine device per reel availability.

Mini-Circuits carrier tape materials provide protection from ESD (Electro-Static Discharge) during handling and transportation. Tapes are static dissipative and comply with industry standards EIA-481/EIA-541.

Go to: www.minicircuits.com/pages/pdfs/tape.pdf



INTERNET <http://www.minicircuits.com>

P.O. Box 350166, Brooklyn, New York 11235-0003 (718) 934-4500 Fax (718) 332-4661

Distribution Centers NORTH AMERICA 800-654-7949 • 417-335-5935 • Fax 417-335-5945 • EUROPE 44-1252-832600 • Fax 44-1252-837010

Mini-Circuits ISO 9001 & ISO 14001 Certified

THIRD ANGLE PROJECTION

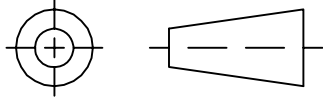

REVISIONS

REV	ECN No.	DESCRIPTION	DATE	DR	AUTH
A	M100215	ADDED "PACKAGE OUTLINE" & UPDATED NOTES	08/12/05	MMG	MM
B	M100944	REMOVED AF190 & UPDATED NOTES	09/23/05	GT	MM
C	M102713	ADDED "...WITH SMOBC"	01/14/06	GF	IL
D	M108434	UPDATED DRAWING PER TB-408+	11/14/06	PW	IG

SUGGESTED MOUNTING CONFIGURATION FOR
WW107 CASE STYLE, "cb" PIN CONNECTION

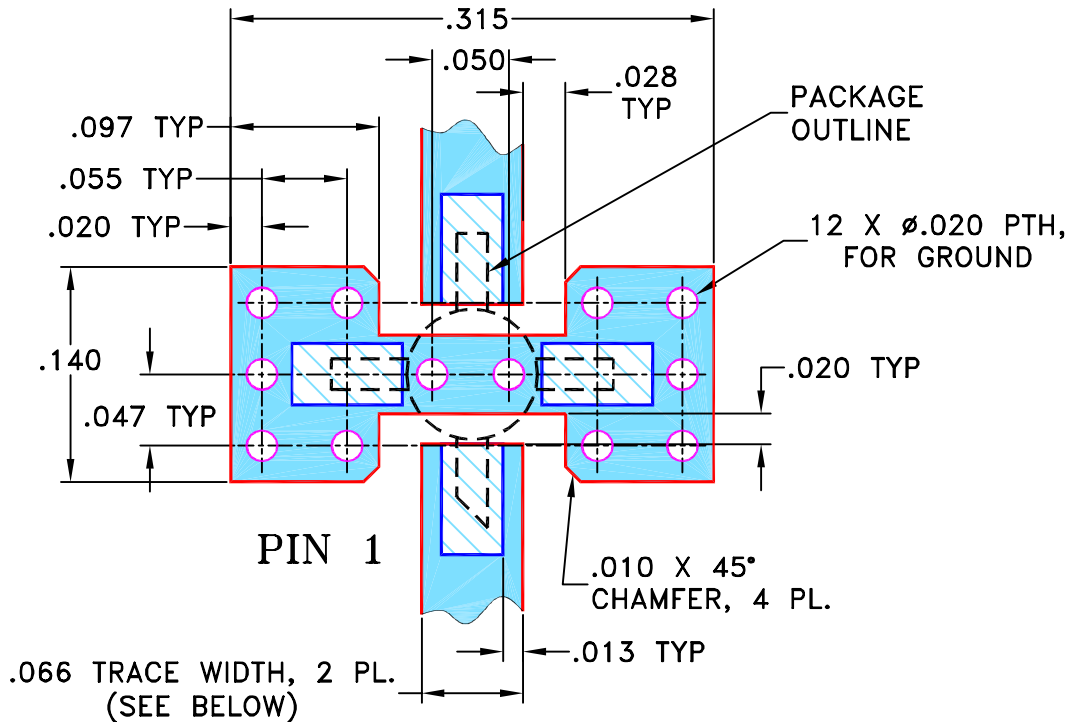

NOTES:

1. TRACE WIDTH IS SHOWN FOR ROGERS R04350B WITH DIELECTRIC THICKNESS $.030'' \pm .002''$; COPPER: 1/2 OZ. EACH SIDE. FOR OTHER MATERIALS TRACE WIDTH MAY NEED TO BE MODIFIED.
2. BOTTOM SIDE OF THE PCB IS CONTINUOUS GROUND PLANE.
3. IF PCB DESIGN RULES ALLOW, PLACE GROUND VIAS UNDER THE LAND PATTERN FOR BETTER RF PERFORMANCE. OTHERWISE PLACE GROUND VIAS AS CLOSE TO LAND PATTERN AS POSSIBLE.

- DENOTES PCB COPPER LAYOUT WITH SMOBC (SOLDER MASK OVER BARE COPPER)
- DENOTES COPPER LAND PATTERN FREE OF SOLDER MASK

UNLESS OTHERWISE SPECIFIED	INITIALS	DATE
DIMENSIONS ARE IN INCHES	DRAWN GF	07/18/02
TOLERANCES ON:	CHECKED LC	08/01/02
2 PL DECIMALS \pm	APPROVED DJ	08/05/02
3 PL DECIMALS \pm .005		
ANGLES \pm		
FRACTIONS \pm		



Mini-Circuits®

13 Neptune Avenue
Brooklyn NY 11235

PL, cb, WW107, ERA, TB-408-XX+

Mini-Circuits®
THIS DOCUMENT AND ITS CONTENTS ARE THE PROPERTY OF MINI-CIRCUITS. EXCEPT FOR USE EXPRESSLY GRANTED, IN WRITING, TO ITS VENDORS, VEEDEE AND THE UNITED STATES GOVERNMENT, MINI-CIRCUITS RESERVES ALL PROPRIETARY DESIGN, USE, MANUFACTURING AND REPRODUCTION RIGHTS THERETO. THESE CONTENTS SHALL NOT BE USED, DUPLICATED OR DISCLOSED TO ANY OUTSIDE PARTY, IN WHOLE OR IN PART, WITHOUT WRITTEN PERMISSION OF MINI-CIRCUITS.

SIZE	CODE IDENT	DRAWING NO:	REV:
A	15542	98-PL-075	D
FILE:	98PL075	SCALE: 8:1	SHEET: 1 OF 1

Evaluation Board and Circuit

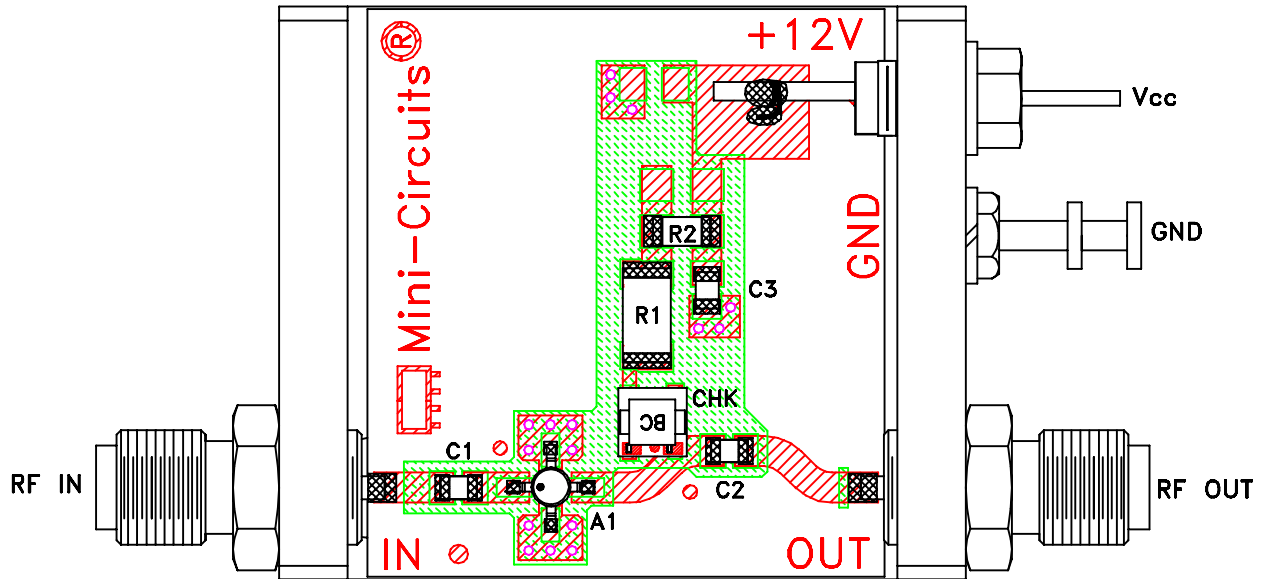

TB-408-6+

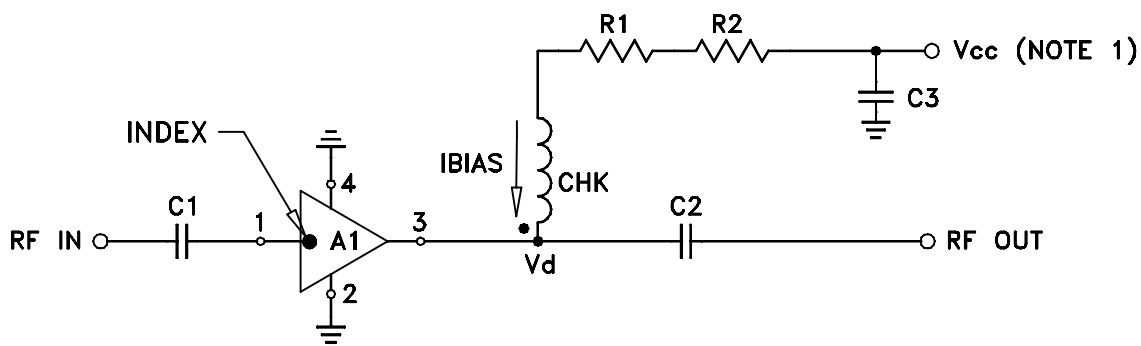

COMPONENT	VALUE
A1	ERA-6SM(+)
C1 (NOTE 4)	2400 pF
C2 (NOTE 4)	2400 pF
C3 (bypass)	0.1 uF
R1	100 Ohms, 0.75W
R2	0 Ohm, 0.25W
CHK	Mini-Circuits TCCH-80+

Schematic Diagram

NOTE:

1. Vcc voltage: $+12 \pm 0.2V$.
2. SMA Female connectors.
3. PCB material: Rogers R04350 or equivalent, dielectric constant=3.5, dielectric thickness=.030 inch.
4. Capacitors, C1 & C2 should be free of resonance up to the highest frequency specified.

 **Mini-Circuits®**

All Mini-Circuits products are manufactured under exacting quality assurance and control standards, and are capable of meeting published specifications after being subjected to any or all of the following physical and environmental test.

Specification	Test/Inspection Condition	Reference/Spec
Operating Temperature	-45° to 85°C or -40° to 85°C Ambient Environment	Individual Model Data Sheet
Storage Temperature	-65° to 150° C Ambient Environment	Individual Model Data Sheet
Thermal Shock	-55° to 100°C, 100 cycles	MIL-STD-202, Method 107, Condition A-3, except +100°C
Mechanical Shock	1.5Kg, 0.5 ms, 5 shock pulses, Y1 direction only	MIL-STD-883, Method 2002, Condition B, except Y1 direction only
Vibration (Variable Frequency)	50g peak	MIL-STD-883, Method 2007, Condition B
Autoclave	15 psig, 100% RH, 121°C, 96 hours	JESD22-A102, Condition C
HAST	130°C, 85% RH, 96 hours	JESD22-A110
Solderability	10X Magnification	J-STD-002, Para 4.2.5, Test S, 95% Coverage
Solder Reflow Heat	Sn-Pb Eutetic Process: 240°C peak Pb-Free Process: 260°C peak	J-STD-020, Table 4-1, 4-2 and 5-2; Figure 5-1
Moisture Sensitivity: Level 1	Bake at 125°C for 24 hours Soak at 85°C/85% RH for 168 hours, Reflow 3 cycles at 260°C peak	J-STD-020
Marking Resistance to Solvents	Isopropyl alcohol + mineral spirits at 25°C; terpene defluxer at 25°C; distilled water + proylene glycol monomethyl ether +	MIL-STD-202, Method 215



All Mini-Circuits products are manufactured under exacting quality assurance and control standards, and are capable of meeting published specifications after being subjected to any or all of the following physical and environmental test.

Specification	Test/Inspection Condition	Reference/Spec
	monoethanolamine at 63°C to 70°C	