

Surface Mount Digital Step Attenuator

DAT-15R5A+ Series

50Ω 0 to 15.5 dB, 0.5 dB Step DC to 4.0 GHz

The Big Deal

- Wideband, operates up to 4 GHz
- Immune to latchup
- High IP3, 52 dBm



CASE STYLE: DG983-2

Product Overview

The DAT-15R5A+ series of 50Ω digital step attenuators provides adjustable attenuation from 0 to 15.5 dB in 0.5 dB steps. The control is a 5-bit serial/parallel interface, and the attenuators operate with either single positive or dual (positive and negative) supply voltage. DAT-15R5A+ series models are produced by a unique CMOS process on silicon, offering the performance of GaAs with the advantages of conventional CMOS devices.

Key Features

Feature	Advantages
Wideband operation, specified from DC to 4.0 GHz	Can be used in multiple applications such as communications, satellite and defense, reducing part count.
Serial or parallel interface	Models available with serial or parallel interface mode to suit customer demand.
Good VSWR, 1.2:1 typ.	Eases interfacing with adjacent components and results in low amplitude ripple.
Single positive supply models: (Model suffixes: -SN+ and -PN+) +2.3 to +3.6V	Use of single positive supply simplifies power supply design. An internal negative voltage generator supplies the desired negative voltage. Single positive supply results in excellent spurious performance, -140 dBm typical.
Dual supply models: (Model suffixes: -SN+ and -PN+) +2.7 to +3.6V (Positive) and -3.6 to -3.2V (Negative)	Dual supply provides spurious-free operation. It also allows fast switching up to 1 MHz (vs. 25 kHz for single supply).
Useable over a wide range of supply voltages, +2.3/2.7 to 5.2V	Wide range of positive operating voltages allows the DAT-15R5A+ Series of models to be used in a wide range of applications. See Application Note AN-70-006 for operation above +3.6V
Footprint compatible to DAT-15R5-XX+ Series (XX=SN/SP/PN/PP)	Can fit into existing footprint and provide improved performance.
Safe attenuation transitions	The DAT-15R5A-XX+ series is designed to prevent any momentary positive 'spikes' in power during attenuation transitions



Digital Step Attenuator

50Ω DC-4000 MHz

15.5 dB, 0.5 dB Step

5 Bit, Serial control interface, Single Supply Voltage

Product Features

- Immune to latch up
- Excellent accuracy, 0.1 dB Typ
- Serial control interface
- Low Insertion Loss
- High IP3, +52 dBm Typ
- Very low DC power consumption
- Excellent return loss, 20 dB Typ
- Small size 4.0 x 4.0 mm



Generic photo used for illustration purposes only

DAT-15R5A-SP+

CASE STYLE: DG983-2

Typical Applications

- Base Station Infrastructure
- Portable Wireless
- CATV & DBS
- MMDS & Wireless LAN
- Wireless Local Loop
- UNII & Hiper LAN
- Power amplifier distortion canceling loops

+RoHS Compliant

The +Suffix identifies RoHS Compliance. See our web site for RoHS Compliance methodologies and qualifications

General Description

The DAT-15R5A-SP+ is a 50Ω digital step attenuator that provides adjustable attenuation of 0 to 15.5 dB in 0.5 dB steps. The control is a 5-bit serial interface, operating with a single (positive) supply voltage. DAT-15R5A-SP+ is produced by a unique CMOS process on silicon, offering the performance of GaAs with the advantages of conventional CMOS devices.

Simplified Schematic

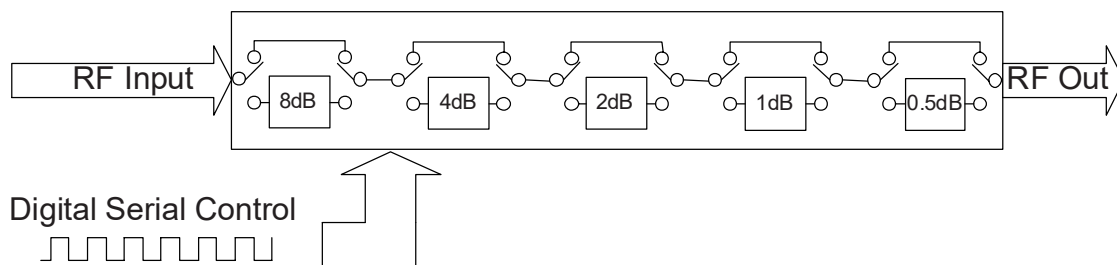

RF Electrical Specifications^(Note1), DC-4000 MHz, T_{AMB}=25°C, V_{DD}=+3V

Parameter	Freq. Range (GHz)	Min.	Typ.	Max.	Units
Accuracy @ 0.5 dB Attenuation Setting	DC-1	—	0.03	0.1	dB
	1-2.4	—	0.05	0.15	
	2.4-4	—	0.07	0.2	
Accuracy @ 1 dB Attenuation Setting	DC-1	—	0.02	0.1	dB
	1-2.4	—	0.05	0.15	
	2.4-4	—	0.1	0.25	
Accuracy @ 2 dB Attenuation Setting	DC-1	—	0.05	0.15	dB
	1-2.4	—	0.15	0.25	
	2.4-4	—	0.15	0.35	
Accuracy @ 4 dB Attenuation Setting	DC-1	—	0.07	0.2	dB
	1-2.4	—	0.15	0.25	
	2.4-4	—	0.23	0.5	
Accuracy @ 8 dB Attenuation Setting	DC-1	—	0.03	0.2	dB
	1-2.4	—	0.15	0.5	
	2.4-4	—	0.6	0.8	
Insertion Loss ^(note 2) @ all attenuator set to 0dB	DC-1	—	1.3	1.9	dB
	1-2.4	—	1.6	2.4	
	2.4-4	—	2.1	3.0	
Input IP3 ^(note 3) (at Min. and Max. Attenuation)	DC-4	—	+52	—	dBm
Input Power @ 0.2dB Compression ^(Note 3) (at Min. and Max. Attenuation)	DC-4	—	+24	—	dBm
Input Operating Power	10 kHz to 50 MHz	—	—	See Fig. 1	dBm
	>50 MHz	—	—	+24	
VSWR	DC-1	—	1.2	1.5	:1
	1-2.4	—	1.2	1.6	
	2.4-4	—	1.4	1.9	

Notes:

1. Tested on Evaluation Board TB-334, See Figure 3.
2. Insertion loss values are de-embedded from test board Loss (test board's Insertion Loss: 0.10dB @ 100MHz, 0.35dB @ 1000MHz, 0.60dB @ 2400MHz, 0.75dB @ 4000MHz).
3. Input IP3 and 1dB compression degrade below 1 MHz. Input power not to exceed max operating specification for continuous operation.

DC Electrical Specifications

Parameter	Min.	Typ.	Max.	Units
V _{DD} , Supply Voltage	2.3	3	3.6 ^(Note 4)	V
I _{DD} Supply Current	—	—	200	µA
Control Input Low	-0.3	—	+0.6	V
Control Input High	1.17	—	3.6	V
Control Current	—	—	20 ^(Note 5)	µA

4. For operation above +3.6V, see Application Note AN-70-006
5. Except, 30µA typ for C0.5 at +3.6V

Absolute Maximum Ratings^(Note6,7)

Parameter	Ratings
Operating Temperature	-40°C to 105°C
Storage Temperature	-65°C to 150°C
V _{DD}	-0.3V Min., 5.5V Max.
Voltage on any control input	-0.3V Min., 3.6V Max.
Input Power	+30dBm
Thermal Resistance	37°C/W

6. Permanent damage may occur if any of these limits are exceeded.
7. Operation between max operating and absolute max input power will result in reduced reliability.

Switching Specifications

Parameter	Min.	Typ.	Max.	Units
Switching Speed, 50% Control to 0.5dB of Attenuation Value	—	1.0	—	µSec
Switching Control Frequency	—	—	25	kHz

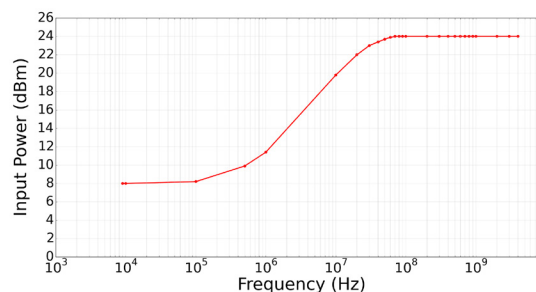

Figure 1. Max Input Operating Power vs Frequency

Digital Step Attenuator

DAT-15R5A-SP+

Pin Description

Function	Pin Number	Description
N/C	1	Not connected (Notes 9)
RF in	2	RF in port (Note 1)
Data	3	Serial Interface data input (Note 3)
Clock	4	Serial Interface clock input
LE	5	Latch Enable Input (Note 2)
V _{DD}	6	Positive Supply Voltage
N/C	7	Not connected
N/C	8	Not connected
V _{DD}	9	Positive Supply Voltage
GND	10	Ground connection
GND	11	Ground connection
GND	12	Ground connection (Note 7)
V _{DD}	13	Positive Supply Voltage (Note 8)
RF out	14	RF out port (Note 1)
C8	15	Control for attenuation bit, 8 dB (Note 4)
C4	16	Control for attenuation bit, 4 dB (Note 4)
C2	17	Control for attenuation bit, 2 dB (Note 4)
GND	18	Ground Connection
C1	19	Control for attenuation bit, 1 dB (Note 4)
C0.5	20	Control for attenuation bit, 0.5 dB (Note 4,6)
GND	Paddle	Paddle ground (Note 5)

Pin Configuration (Top View)

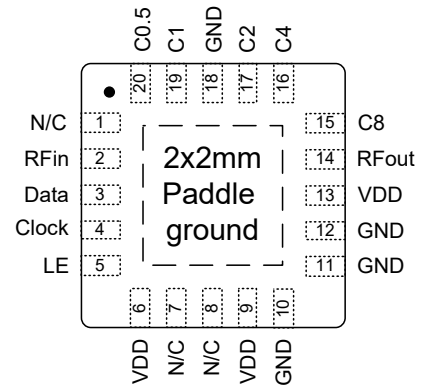

Device Marking

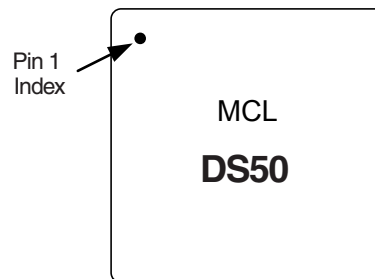

Notes:

- Both RF ports must be held at 0VDC or DC blocked with an external series capacitor.
- Latch Enable (LE) has an internal 2MΩ to internal positive supply voltage.
- Place a 10KΩ resistor in series, as close to pin as possible to avoid freq. resonance.
- Refer to Power-up Control Settings.
- The exposed solder pad on the bottom of the package (See Pin configuration) must be grounded for proper device operation.
- This pin has an internal 200 kΩ resistor to ground.
- Ground must be less than 80 mil (0.08") from pin 12 proper device operation.
- When VDD ≤ 3.6V this pin may be connected directly to VDD, when 3.6V < VDD ≤ 5.2V need to use a voltage divider to reduce voltage on this pin to a voltage in the range +1.17 to 3.6V. See Application note AN-70-006.
- Place a shunt 10kΩ resistor to ground.

Simplified Schematic

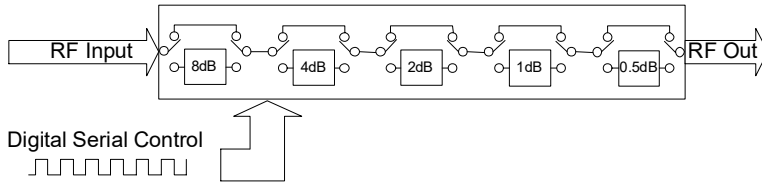

The DAT-15R5A-SP+ serial interface consists of 5 control bits that select the desired attenuation state, as shown in Table 1: Truth Table

Table 1. Truth Table					
Attenuation State	C8	C4	C2	C1	C0.5
Reference	0	0	0	0	0
0.5 (dB)	0	0	0	0	1
1 (dB)	0	0	0	1	0
2 (dB)	0	0	1	0	0
4 (dB)	0	1	0	0	0
8 (dB)	1	0	0	0	0
15.5 (dB)	1	1	1	1	1

Note: Not all 32 possible combinations of C0.5 - C8 are shown in table

The serial interface is a 5-bit serial in, parallel-out shift register buffered by a transparent latch. It is controlled by three CMOS-compatible signals: Data, Clock, and Latch Enable (LE). The Data and Clock inputs allow data to be serially entered into the shift register, a process that is independent of the state of the LE input.

The LE input controls the latch. When LE is HIGH, the latch is transparent and the contents of the serial shift register control the attenuator. When LE is brought LOW, data in the shift register is latched.

The shift register should be loaded while LE is held LOW to prevent the attenuator value from changing as data is entered. The LE input should then be toggled HIGH and brought LOW again, latching the new data. The timing for this operation is defined by **Figure 2** (Serial Interface Timing Diagram) and **Table 2** (Serial Interface AC Characteristics).

Figure 2: Serial interface Timing Diagram

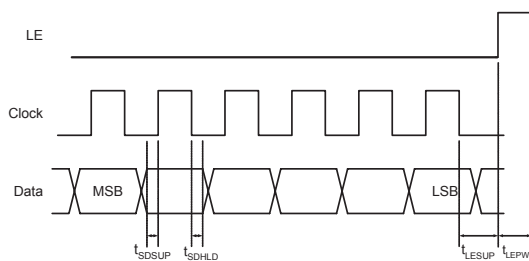

Table 2. Serial Interface AC Characteristics

Symbol	Parameter	Min.	Max.	Units
f_{clk}	Serial data clock frequency (Note 1)		10	MHz
t_{clkH}	Serial clock HIGH time	30		ns
t_{clkL}	Serial clock LOW time	30		ns
t_{LESUP}	LE set-up time after last clock falling edge	10		ns
t_{LEPW}	LE minimum pulse width	30		ns
t_{SDSUP}	Serial data set-up time before clock rising edge	10		ns
t_{SDHLD}	Serial data hold time after clock falling edge	10		ns

Note 1. f_{clk} verified during the functional pattern test. Serial programming sections of the functional pattern are clocked at 10MHz to verify f_{clk} specification.

The DAT-15R5A-SP+, uses a common 5-bit serial word format, as shown in **Table 3**: 5-Bit attenuator Serial Programming Register Map.

The second bit B4 corresponds to the 8 dB Step and the last bit B0 corresponds to the 0.5 dB step.

Table 3. 5-Bit attenuator Serial Programming Register Map					
B5	B4	B3	B2	B1	B0
0	C8	C4	C2	C1	C0.5

↑

MSB
(first in)

↑

LSB
(last in)

Note: The stop bit (B5) must always be low to prevent the attenuator from entering an unknown state.

Power-up Control Settings

The DAT-15R5A-SP+ always assumes a specifiable attenuation setting on power-up, allowing a known attenuation state to be established before an initial serial control word is provided.

When the attenuator powers up, the five control bits are set to whatever data is present on the five data inputs (C0.5 to C8).

This allows any one of the 32 attenuation settings to be specified as the power-up state.

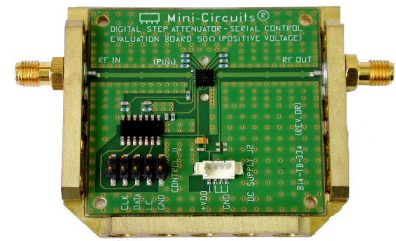
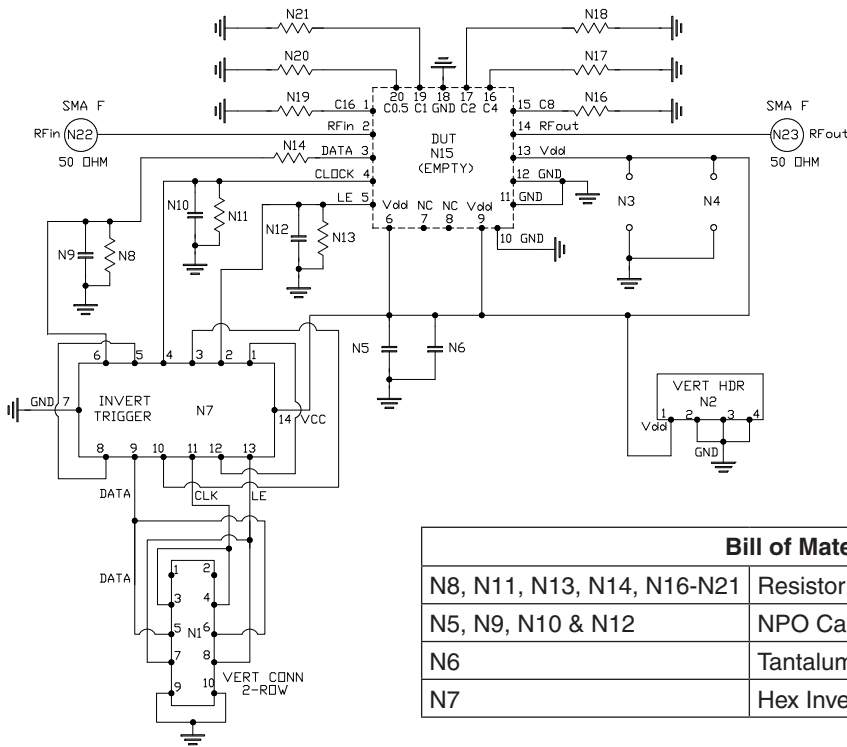

TB-334

Bill of Materials	
N8, N11, N13, N14, N16-N21	Resistor 0603 10 KOhm +/- 1%
N5, N9, N10 & N12	NPO Capacitor 0603 100pF +/- 5%
N6	Tantalum Capacitor 0805 100nF +/- 10%
N7	Hex Invert Schmitt Trigger MSL1

Notes

1. Both RF ports must be held at 0VDC or DC blocked with an external series capacitor.
2. Test Board TB-334 is designed for operation for VDD=2.3 to 3.6V. For operation over 3.6V to 5.2V, See Application Note AN-70-006
3. VDD=Vdd

Fig 3. Evaluation Board Schematic, TB-334, used for characterization (DUT not soldered on TB-334)

Test Equipment

- For Insertion Loss, Isolation and Return Loss:**
Agilent's E5071C Network Analyzer & E3631A Power Supply.
- For Compression:**
Agilent's N9020A Signal Analyzer, E8247C RF Generator, E3631A Power Supply & U2004A Power Sensor.
- For Input IP3:**
Agilent's N9020A Signal Analyzer, N5181A Signal Generators, E3631A Power Supply, U2004A Power Sensor.
- For Spurs:**
Agilent N5181A Signal Generator, E4440A Spectrum Analyzer.
- For Switching Time:**
Agilent's N5181A Signal Generator, 81110A Pulse Generator, 54832B Oscilloscope, E3631A Power Supply.
- For Max Control Frequency:**
Agilent's N5181A Signal Generator, N9020A Signal Analyzer, E3631A Power Supply, 81110A Pulse Generator.

Measurement Conditions

- For Insertion Loss, Isolation and Return Loss:**
VDD=+2.3/+3/+5.5V & Pin=0dBm
- For Compression:** Pin=0/+24dBm. VDD=+3V
- For Input IP3:** Pin=+10dBm/tone.
Tone spacing: 0.1 MHz to 1 MHz RF Freq and 1 MHz to 4200 MHz RF Freq, VDD=+3V
- For Spurs:** RF IN at 1000MHz and -20dBm. VDD=+3V
- For Switching Time:**
RF Freq=501MHz/0dBm, Pulse for LE=1Hz/0/+3.4V, Delay=500ms, Width=500ms. VDD=+3V
- For Max Control Frequency:**
RF Freq=501MHz, 0dBm. VDD=+3V

Additional Detailed Technical Information	
<i>additional information is available on our dash board. To access this information click here</i>	
Performance Data	Data Table
	Swept Graphs
	S-Parameter (S2P Files) Data Set (.zip file)
Case Style	DG983-2 <i>Plastic package, exposed paddle, lead finish: NiPdAu</i>
Tape & Reel Standard quantities available on reel	F87 <i>7" reels with 20, 50, 100 or 200 devices</i> <i>13" reels with 3K devices</i>
Suggested Layout for PCB Design	PL-199
Evaluation Board	TB-334
Environmental Ratings	ENV33T1

ESD Rating

Human Body Model (HBM): Class 1C (1000 to <2000V) in accordance with MIL-STD-883 method 3015

MSL Rating

Moisture Sensitivity: MSL1 in accordance with IPC/JEDEC J-STD-020D

MSL Test Flow Chart

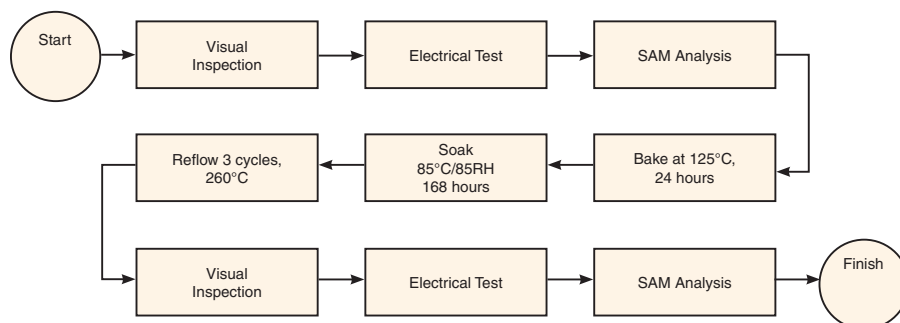

Additional Notes

- Performance and quality attributes and conditions not expressly stated in this specification document are intended to be excluded and do not form a part of this specification document.
- Electrical specifications and performance data contained in this specification document are based on Mini-Circuit's applicable established test performance criteria and measurement instructions.
- The parts covered by this specification document are subject to Mini-Circuits standard limited warranty and terms and conditions (collectively, "Standard Terms"); Purchasers of this part are entitled to the rights and benefits contained therein. For a full statement of the Standard Terms and the exclusive rights and remedies thereunder, please visit Mini-Circuits' website at www.minicircuits.com/MCLStore/terms.jsp

Digital Step Attenuator **DAT-15R5A-SP+**

Typical Performance Data

TEST CONDITIONS: INPUT POWER=0 dBm, Vdd=+3V, TEMPERATURE=-40°C

FREQUENCY (MHz)	STEP ATTENUATION* AT TTL CONTROL STATE (dB)					
	000000 THRU LOSS	000001 0.5 dB	000010 1.0 dB	000100 2.0 dB	001000 4.0 dB	010000 8.0 dB
0.1	1.02	0.54	1.05	2.06	4.08	8.08
0.3	1.01	0.55	1.05	2.06	4.09	8.09
0.5	1.01	0.54	1.05	2.06	4.09	8.10
1	1.01	0.54	1.05	2.06	4.08	8.09
5	1.04	0.54	1.05	2.06	4.08	8.08
10	1.04	0.54	1.05	2.06	4.08	8.08
50	1.06	0.54	1.04	2.05	4.08	8.07
100	1.06	0.54	1.04	2.05	4.07	8.07
200	1.07	0.54	1.04	2.05	4.07	8.07
300	1.07	0.54	1.05	2.06	4.08	8.08
400	1.07	0.54	1.05	2.06	4.08	8.08
500	1.08	0.54	1.04	2.06	4.08	8.08
600	1.10	0.54	1.04	2.05	4.07	8.08
700	1.12	0.54	1.04	2.05	4.07	8.07
800	1.15	0.54	1.04	2.04	4.06	8.07
900	1.18	0.54	1.04	2.04	4.06	8.07
1000	1.20	0.54	1.04	2.04	4.06	8.08
1100	1.21	0.54	1.04	2.04	4.06	8.09
1200	1.23	0.54	1.04	2.04	4.06	8.09
1300	1.25	0.54	1.04	2.04	4.06	8.10
1400	1.27	0.54	1.04	2.05	4.07	8.11
1500	1.30	0.54	1.04	2.05	4.07	8.12
1600	1.32	0.54	1.04	2.05	4.08	8.14
1700	1.35	0.54	1.05	2.05	4.08	8.15
1800	1.36	0.55	1.05	2.06	4.09	8.17
1900	1.37	0.55	1.06	2.07	4.11	8.20
2000	1.38	0.55	1.06	2.08	4.13	8.24
2100	1.40	0.56	1.07	2.09	4.14	8.28
2200	1.42	0.56	1.08	2.11	4.17	8.33
2300	1.44	0.57	1.09	2.12	4.19	8.38
2400	1.45	0.57	1.09	2.14	4.21	8.42
2500	1.46	0.58	1.10	2.15	4.24	8.47
2600	1.48	0.58	1.10	2.16	4.26	8.52
2700	1.50	0.58	1.11	2.17	4.27	8.56
2800	1.52	0.58	1.10	2.17	4.27	8.59
2900	1.53	0.58	1.10	2.16	4.26	8.59
3000	1.53	0.57	1.09	2.15	4.24	8.59
3200	1.52	0.56	1.07	2.11	4.19	8.56
3400	1.55	0.55	1.05	2.08	4.15	8.55
3600	1.62	0.54	1.04	2.07	4.13	8.55
3800	1.70	0.54	1.04	2.08	4.13	8.56
4000	1.76	0.54	1.04	2.08	4.14	8.58
4200	1.77	0.55	1.06	2.10	4.16	8.64
4400	1.84	0.56	1.08	2.13	4.21	8.77
4600	1.89	0.58	1.10	2.17	4.28	8.98
4800	1.94	0.59	1.12	2.21	4.37	9.23
5000	1.97	0.60	1.14	2.25	4.45	9.46

* Step Attenuation above Thru Loss (TTL Logic 00000).



REV. A
DAT-15R5A-SP+
6/13/2016
1 of 9

P.O. Box 350166, Brooklyn, New York 11235-0003 (718) 934-4500 • Fax (718) 332-4661 For detailed performance specs & shopping online see Mini-Circuits web site
The Design Engineers Search Engine Provides ACTUAL Data Instantly From MINI-CIRCUITS At: www.minicircuits.com

IF/RF MICROWAVE COMPONENTS

Digital Step Attenuator **DAT-15R5A-SP+**

Typical Performance Data

TEST CONDITIONS: INPUT POWER=0 dBm, Vdd=+3V, TEMPERATURE=-40°C

FREQUENCY (MHz)	INPUT RETURN LOSS AT TTL CONTROL STATE (dB)					
	000000	000001	000010	000100	001000	010000
	0 dB	0.5 dB	1.0 dB	2.0 dB	4.0 dB	8.0 dB
0.1	19.12	20.90	22.75	21.00	22.72	27.63
0.3	19.30	21.10	22.95	21.21	22.95	27.93
0.5	19.33	21.14	23.00	21.25	23.00	28.07
1	19.44	21.23	23.11	21.32	23.05	28.07
5	19.37	21.18	23.06	21.25	22.95	27.92
10	19.35	21.18	23.05	21.24	22.93	27.88
50	19.21	20.97	22.76	20.97	22.55	27.09
100	19.19	20.88	22.60	20.79	22.22	26.33
200	19.15	20.82	22.51	20.77	22.22	26.39
300	19.59	21.40	23.26	21.43	23.12	28.10
400	19.72	21.57	23.50	21.64	23.39	28.58
500	19.16	20.91	22.71	20.98	22.61	27.18
600	19.24	20.93	22.65	20.85	22.29	26.44
700	19.51	21.19	22.88	20.98	22.33	26.36
800	19.43	21.04	22.64	20.73	21.96	25.68
900	19.26	20.78	22.25	20.45	21.61	25.23
1000	19.07	20.51	21.89	20.26	21.46	25.19
1100	18.90	20.26	21.56	20.06	21.28	25.08
1200	18.78	20.05	21.25	19.88	21.10	24.92
1300	18.40	19.55	20.60	19.50	20.78	24.68
1400	18.35	19.41	20.35	19.50	20.86	25.06
1500	18.09	19.08	19.96	19.33	20.80	25.22
1600	17.60	18.48	19.26	18.89	20.42	24.84
1700	17.07	17.88	18.56	18.45	20.06	24.46
1800	16.48	17.22	17.84	17.94	19.62	23.90
1900	16.16	16.85	17.41	17.71	19.45	23.55
2000	16.17	16.86	17.38	17.81	19.61	23.45
2100	16.28	16.96	17.42	17.96	19.75	23.08
2200	16.61	17.30	17.72	18.35	20.14	22.91
2300	17.07	17.78	18.18	18.87	20.63	22.76
2400	17.52	18.22	18.53	19.26	20.83	22.02
2500	18.53	19.21	19.38	20.17	21.38	21.30
2600	20.11	20.76	20.68	21.56	22.14	20.58
2700	22.49	23.19	22.70	23.68	23.22	20.11
2800	25.66	26.66	25.32	26.44	24.25	19.74
2900	30.64	31.76	27.67	29.05	24.44	19.20
3000	37.28	35.97	28.50	30.20	24.28	18.83
3200	32.66	32.11	27.89	30.06	24.41	18.81
3400	34.70	31.89	27.68	30.70	25.25	19.53
3600	42.10	31.05	26.91	29.55	25.88	20.62
3800	28.48	27.44	25.60	26.58	26.04	22.40
4000	22.12	21.93	21.44	21.81	22.57	22.47
4200	18.41	18.46	18.26	18.55	19.49	20.62
4400	16.55	16.60	16.43	16.81	17.57	18.57
4600	15.77	15.82	15.58	16.05	16.67	17.16
4800	16.16	16.16	15.78	16.33	16.72	16.54
5000	18.21	17.86	17.01	17.70	17.30	15.71



REV. A
 DAT-15R5A-SP+
 6/13/2016
 2 of 9

P.O. Box 350166, Brooklyn, New York 11235-0003 (718) 934-4500 • Fax (718) 332-4661 For detailed performance specs & shopping online see Mini-Circuits web site
 The Design Engineers Search Engine Provides ACTUAL Data Instantly From MINI-CIRCUITS At: www.minicircuits.com

Digital Step Attenuator **DAT-15R5A-SP+**

Typical Performance Data

TEST CONDITIONS: INPUT POWER=0 dBm, Vdd=+3V, TEMPERATURE=-40°C

FREQUENCY (MHz)	OUTPUT RETURN LOSS AT TTL CONTROL STATE (dB)					
	000000 0 dB	000001 0.5 dB	000010 1.0 dB	000100 2.0 dB	001000 4.0 dB	010000 8.0 dB
0.1	18.73	19.54	19.92	25.83	32.09	46.89
0.3	18.92	19.73	20.11	26.08	32.44	48.05
0.5	19.01	19.82	20.20	26.22	32.74	50.19
1	19.10	19.91	20.28	26.35	32.91	50.10
5	19.15	19.96	20.33	26.44	32.96	49.97
10	19.15	19.96	20.33	26.43	32.91	49.21
50	19.14	19.92	20.26	26.19	32.16	43.30
100	18.96	19.69	20.00	25.54	30.64	38.63
200	18.82	19.54	19.85	25.22	30.01	37.35
300	18.80	19.58	19.93	25.50	30.79	40.17
400	19.20	20.02	20.38	26.34	32.36	45.56
500	19.68	20.49	20.84	27.18	33.87	49.33
600	19.71	20.45	20.73	26.71	32.25	40.64
700	19.63	20.31	20.55	26.21	30.99	38.75
800	19.96	20.58	20.77	26.38	30.61	37.63
900	20.01	20.57	20.73	25.91	29.31	35.27
1000	20.19	20.70	20.84	25.70	28.56	34.27
1100	20.07	20.54	20.68	25.21	27.79	33.38
1200	19.72	20.14	20.28	24.19	26.32	31.26
1300	19.19	19.58	19.76	23.10	25.00	29.63
1400	18.35	18.74	18.96	21.86	23.63	27.98
1500	17.66	18.04	18.28	20.80	22.40	26.33
1600	16.95	17.30	17.58	19.75	21.20	24.82
1700	16.20	16.55	16.83	18.70	20.02	23.28
1800	15.51	15.87	16.17	17.78	18.98	21.94
1900	15.03	15.40	15.73	17.16	18.26	20.96
2000	14.88	15.27	15.61	16.92	17.92	20.39
2100	14.82	15.22	15.56	16.81	17.71	19.94
2200	14.91	15.32	15.66	16.80	17.54	19.45
2300	15.31	15.71	16.05	17.05	17.57	19.10
2400	15.77	16.19	16.52	17.37	17.66	18.80
2500	16.42	16.86	17.20	17.90	17.92	18.63
2600	17.49	17.98	18.32	18.84	18.43	18.56
2700	19.04	19.63	19.98	20.28	19.20	18.60
2800	21.21	22.01	22.43	22.22	20.14	18.69
2900	23.30	24.70	25.41	24.84	21.36	18.94
3000	24.52	26.80	28.29	28.37	22.81	19.38
3200	23.30	25.62	27.31	33.44	25.25	20.16
3400	21.55	23.20	24.24	29.38	26.44	20.71
3600	20.86	22.21	22.94	28.10	27.89	21.65
3800	21.51	22.76	23.37	30.15	30.83	23.00
4000	23.74	24.88	25.33	49.88	34.83	25.37
4200	24.39	24.87	25.14	28.49	26.32	24.39
4400	22.68	22.72	22.89	22.61	21.48	21.11
4600	22.30	22.09	22.07	19.96	18.80	18.07
4800	23.15	22.51	22.18	18.49	17.12	15.84
5000	24.86	23.42	22.61	17.49	15.90	14.09



REV. A
 DAT-15R5A-SP+
 6/13/2016
 3 of 9

P.O. Box 350166, Brooklyn, New York 11235-0003 (718) 934-4500 • Fax (718) 332-4661 For detailed performance specs & shopping online see Mini-Circuits web site



The Design Engineers Search Engine Provides ACTUAL Data Instantly From MINI-CIRCUITS At: www.minicircuits.com

IF/RF MICROWAVE COMPONENTS

Digital Step Attenuator **DAT-15R5A-SP+**

Typical Performance Data

TEST CONDITIONS: INPUT POWER=0 dBm, Vdd=+3V, TEMPERATURE=+25degC

FREQUENCY (MHz)	STEP ATTENUATION* AT TTL CONTROL STATE (dB)					
	000000 THRU LOSS	000001 0.5 dB	000010 1.0 dB	000100 2.0 dB	001000 4.0 dB	010000 8.0 dB
0.1	1.13	0.53	1.02	2.02	4.02	7.97
0.3	1.12	0.53	1.03	2.02	4.03	7.98
0.5	1.12	0.53	1.02	2.02	4.03	7.98
1	1.12	0.53	1.02	2.02	4.03	7.98
5	1.15	0.53	1.02	2.02	4.02	7.97
10	1.15	0.53	1.02	2.02	4.02	7.97
50	1.16	0.53	1.02	2.02	4.02	7.97
100	1.16	0.53	1.02	2.02	4.02	7.97
200	1.16	0.53	1.02	2.02	4.02	7.97
300	1.17	0.52	1.02	2.02	4.01	7.96
400	1.18	0.52	1.02	2.01	4.01	7.96
500	1.19	0.52	1.01	2.01	4.01	7.96
600	1.21	0.52	1.01	2.01	4.01	7.96
700	1.22	0.52	1.01	2.01	4.01	7.96
800	1.24	0.52	1.01	2.01	4.00	7.97
900	1.26	0.52	1.01	2.01	4.00	7.97
1000	1.29	0.52	1.01	2.01	4.00	7.98
1100	1.31	0.52	1.01	2.01	4.01	7.98
1200	1.34	0.52	1.01	2.01	4.00	7.98
1300	1.36	0.52	1.01	2.01	4.00	7.99
1400	1.38	0.52	1.01	2.01	4.00	7.99
1500	1.41	0.52	1.01	2.01	4.01	8.00
1600	1.43	0.52	1.01	2.01	4.01	8.01
1700	1.46	0.53	1.02	2.01	4.01	8.02
1800	1.48	0.53	1.02	2.02	4.02	8.04
1900	1.50	0.53	1.03	2.02	4.03	8.06
2000	1.51	0.53	1.03	2.03	4.04	8.09
2100	1.53	0.54	1.04	2.05	4.06	8.13
2200	1.55	0.54	1.05	2.06	4.08	8.18
2300	1.56	0.55	1.05	2.07	4.10	8.22
2400	1.57	0.55	1.06	2.09	4.12	8.27
2500	1.58	0.55	1.06	2.10	4.14	8.32
2600	1.60	0.55	1.07	2.10	4.16	8.36
2700	1.62	0.55	1.07	2.10	4.16	8.39
2800	1.64	0.55	1.06	2.10	4.16	8.41
2900	1.65	0.55	1.06	2.09	4.15	8.42
3000	1.66	0.55	1.05	2.08	4.14	8.43
3200	1.64	0.54	1.03	2.06	4.10	8.42
3400	1.68	0.53	1.01	2.04	4.07	8.41
3600	1.75	0.52	1.01	2.03	4.05	8.42
3800	1.83	0.52	1.01	2.04	4.05	8.43
4000	1.88	0.52	1.01	2.05	4.06	8.44
4200	1.91	0.53	1.02	2.06	4.07	8.49
4400	1.99	0.54	1.04	2.08	4.11	8.60
4600	2.03	0.55	1.06	2.12	4.18	8.81
4800	2.07	0.57	1.09	2.17	4.27	9.08
5000	2.13	0.58	1.11	2.21	4.35	9.32

* Step Attenuation above Thru Loss (TTL Logic 00000).



REV. A
DAT-15R5A-SP+
6/13/2016
4 of 9

P.O. Box 350166, Brooklyn, New York 11235-0003 (718) 934-4500 • Fax (718) 332-4661 For detailed performance specs & shopping online see Mini-Circuits web site
The Design Engineers Search Engine Provides ACTUAL Data Instantly From MINI-CIRCUITS At: www.minicircuits.com

IF/RF MICROWAVE COMPONENTS

Digital Step Attenuator **DAT-15R5A-SP+**

Typical Performance Data

TEST CONDITIONS: INPUT POWER=0 dBm, Vdd=+3V, TEMPERATURE=+25degC

FREQUENCY (MHz)	INPUT RETURN LOSS AT TTL CONTROL STATE (dB)					
	000000	000001	000010	000100	001000	010000
	0 dB	0.5 dB	1.0 dB	2.0 dB	4.0 dB	8.0 dB
0.1	18.18	19.42	20.62	18.72	19.29	21.27
0.3	18.35	19.58	20.78	18.87	19.44	21.40
0.5	18.35	19.59	20.78	18.88	19.47	21.46
1	18.45	19.68	20.88	18.94	19.50	21.45
5	18.40	19.65	20.85	18.91	19.45	21.42
10	18.40	19.65	20.85	18.90	19.46	21.41
50	18.42	19.66	20.86	18.91	19.46	21.40
100	18.53	19.77	20.97	19.00	19.52	21.44
200	18.44	19.66	20.83	18.91	19.41	21.27
300	18.48	19.68	20.83	18.88	19.33	21.08
400	18.59	19.76	20.88	18.89	19.26	20.89
500	18.57	19.71	20.80	18.79	19.11	20.63
600	18.60	19.70	20.74	18.69	18.94	20.32
700	18.57	19.62	20.60	18.53	18.69	19.93
800	18.54	19.54	20.46	18.37	18.45	19.59
900	18.48	19.42	20.28	18.23	18.27	19.36
1000	18.39	19.27	20.07	18.08	18.11	19.18
1100	18.11	18.92	19.65	17.84	17.90	19.02
1200	17.83	18.57	19.22	17.62	17.74	18.92
1300	17.39	18.05	18.65	17.35	17.58	18.92
1400	16.89	17.50	18.04	17.07	17.46	19.02
1500	16.33	16.89	17.39	16.74	17.30	19.11
1600	15.79	16.32	16.80	16.43	17.17	19.26
1700	15.36	15.86	16.31	16.19	17.12	19.53
1800	15.03	15.53	15.95	16.05	17.16	19.91
1900	14.82	15.31	15.72	16.00	17.25	20.34
2000	14.76	15.25	15.63	16.07	17.46	20.83
2100	14.90	15.38	15.73	16.31	17.83	21.44
2200	15.29	15.77	16.09	16.81	18.43	22.22
2300	15.92	16.40	16.68	17.51	19.23	23.02
2400	16.69	17.18	17.40	18.35	20.12	23.65
2500	17.91	18.41	18.54	19.64	21.43	24.20
2600	19.58	20.05	20.02	21.34	23.04	24.21
2700	21.91	22.37	22.02	23.69	25.01	23.89
2800	24.77	25.32	24.46	26.68	27.15	23.43
2900	28.54	29.18	27.10	30.35	28.72	22.88
3000	33.87	34.45	29.49	34.57	29.19	22.24
3200	34.82	35.97	30.76	35.02	28.51	21.55
3400	33.47	36.69	32.32	37.44	30.87	22.72
3600	36.21	41.44	33.63	42.00	40.10	25.69
3800	25.52	26.05	25.71	26.13	28.98	33.52
4000	19.83	20.03	19.99	20.35	21.99	28.21
4200	16.88	17.00	16.95	17.48	18.78	22.77
4400	15.00	15.06	14.95	15.63	16.68	19.22
4600	14.32	14.34	14.13	14.92	15.78	17.47
4800	14.95	14.85	14.45	15.41	16.01	16.69
5000	17.32	16.86	16.05	17.27	17.26	16.34



REV. A
 DAT-15R5A-SP+
 6/13/2016
 5 of 9

P.O. Box 350166, Brooklyn, New York 11235-0003 • Fax (718) 934-4500 • Fax (718) 332-4661 For detailed performance specs & shopping online see Mini-Circuits web site



The Design Engineers Search Engine Provides ACTUAL Data Instantly From MINI-CIRCUITS At: www.minicircuits.com

IF/RF MICROWAVE COMPONENTS

Digital Step Attenuator **DAT-15R5A-SP+**

Typical Performance Data

TEST CONDITIONS: INPUT POWER=0 dBm, Vdd=+3V, TEMPERATURE=+25degC

FREQUENCY (MHz)	OUTPUT RETURN LOSS AT TTL CONTROL STATE (dB)					
	000000 0 dB	000001 0.5 dB	000010 1.0 dB	000100 2.0 dB	001000 4.0 dB	010000 8.0 dB
0.1	17.90	18.31	18.37	22.29	24.60	26.28
0.3	18.05	18.47	18.53	22.43	24.72	26.38
0.5	18.12	18.53	18.59	22.52	24.82	26.49
1	18.22	18.61	18.66	22.60	24.88	26.48
5	18.27	18.67	18.71	22.69	24.94	26.51
10	18.28	18.69	18.72	22.69	24.93	26.50
50	18.29	18.69	18.73	22.68	24.90	26.46
100	18.24	18.64	18.68	22.57	24.73	26.24
200	18.25	18.63	18.67	22.49	24.59	25.99
300	18.30	18.67	18.69	22.44	24.42	25.65
400	18.43	18.77	18.76	22.45	24.28	25.29
500	18.48	18.80	18.76	22.36	24.03	24.86
600	18.66	18.94	18.86	22.39	23.86	24.46
700	18.87	19.09	18.96	22.42	23.68	24.09
800	19.10	19.26	19.07	22.43	23.48	23.74
900	19.12	19.23	19.01	22.22	23.10	23.35
1000	19.04	19.10	18.87	21.85	22.61	22.96
1100	18.80	18.82	18.61	21.33	22.03	22.59
1200	18.38	18.39	18.23	20.63	21.33	22.18
1300	17.69	17.74	17.65	19.74	20.52	21.75
1400	16.92	17.01	17.01	18.82	19.68	21.31
1500	16.15	16.28	16.36	17.94	18.88	20.84
1600	15.44	15.61	15.75	17.15	18.15	20.43
1700	14.81	15.03	15.22	16.47	17.51	20.02
1800	14.31	14.56	14.79	15.93	17.00	19.69
1900	13.97	14.24	14.50	15.55	16.62	19.44
2000	13.80	14.09	14.37	15.33	16.38	19.27
2100	13.79	14.10	14.40	15.29	16.30	19.22
2200	14.00	14.32	14.63	15.45	16.40	19.29
2300	14.46	14.79	15.11	15.84	16.70	19.51
2400	15.14	15.49	15.81	16.43	17.16	19.83
2500	16.06	16.42	16.75	17.27	17.84	20.27
2600	17.29	17.69	18.03	18.43	18.74	20.81
2700	18.85	19.30	19.67	19.99	19.93	21.46
2800	20.81	21.40	21.81	22.06	21.45	22.15
2900	22.71	23.59	24.14	24.71	23.26	22.82
3000	24.02	25.33	26.15	28.62	25.65	23.49
3200	22.84	24.28	25.08	51.66	32.65	24.37
3400	20.77	21.81	22.28	30.51	34.89	24.56
3600	20.02	20.84	21.11	27.61	31.96	24.98
3800	21.16	21.78	21.86	29.13	33.32	27.30
4000	22.79	23.04	22.99	28.96	30.31	34.92
4200	22.17	22.12	22.21	23.84	24.24	34.09
4400	20.28	20.26	20.47	20.21	20.47	24.66
4600	19.52	19.52	19.73	18.35	18.34	20.26
4800	20.18	20.12	20.22	17.61	17.22	17.57
5000	22.57	22.09	21.82	17.49	16.59	15.62



REV. A
 DAT-15R5A-SP+
 6/13/2016
 6 of 9

P.O. Box 350166, Brooklyn, New York 11235-0003 (718) 934-4500 • Fax (718) 332-4661 For detailed performance specs & shopping online see Mini-Circuits web site



The Design Engineers Search Engine Provides ACTUAL Data Instantly From MINI-CIRCUITS At: www.minicircuits.com

IF/RF MICROWAVE COMPONENTS

Digital Step Attenuator **DAT-15R5A-SP+**

Typical Performance Data

TEST CONDITIONS: INPUT POWER=0 dBm, Vdd=+3V, TEMPERATURE=+105°C

FREQUENCY (MHz)	STEP ATTENUATION* AT TTL CONTROL STATE (dB)					
	000000 THRU LOSS	000001 0.5 dB	000010 1.0 dB	000100 2.0 dB	001000 4.0 dB	010000 8.0 dB
0.1	1.30	0.51	1.00	1.99	3.97	7.88
0.3	1.28	0.51	1.00	1.99	3.97	7.89
0.5	1.28	0.51	1.00	1.99	3.97	7.89
1	1.29	0.51	1.00	1.99	3.97	7.89
5	1.31	0.51	1.00	1.99	3.97	7.88
10	1.31	0.51	1.00	1.99	3.97	7.88
50	1.32	0.51	1.00	1.99	3.97	7.88
100	1.30	0.51	1.00	1.99	3.97	7.88
200	1.31	0.51	1.00	1.99	3.97	7.88
300	1.33	0.51	0.99	1.98	3.96	7.88
400	1.35	0.51	0.99	1.98	3.96	7.88
500	1.37	0.51	0.99	1.98	3.96	7.89
600	1.39	0.50	0.99	1.98	3.96	7.89
700	1.41	0.50	0.99	1.98	3.97	7.90
800	1.44	0.50	0.99	1.98	3.97	7.91
900	1.46	0.51	0.99	1.99	3.97	7.92
1000	1.49	0.51	0.99	1.99	3.98	7.92
1100	1.51	0.51	0.99	1.99	3.98	7.92
1200	1.54	0.51	0.99	1.99	3.97	7.92
1300	1.57	0.51	0.99	1.99	3.97	7.92
1400	1.59	0.51	0.99	1.98	3.96	7.92
1500	1.62	0.51	0.99	1.98	3.96	7.91
1600	1.65	0.51	0.99	1.98	3.95	7.91
1700	1.67	0.51	0.99	1.98	3.95	7.92
1800	1.70	0.51	1.00	1.98	3.95	7.92
1900	1.72	0.51	1.00	1.99	3.96	7.94
2000	1.73	0.51	1.00	1.99	3.96	7.96
2100	1.75	0.52	1.01	2.00	3.97	7.99
2200	1.77	0.52	1.01	2.01	3.99	8.02
2300	1.78	0.52	1.02	2.02	4.00	8.07
2400	1.79	0.53	1.02	2.03	4.02	8.11
2500	1.80	0.53	1.03	2.04	4.03	8.15
2600	1.82	0.53	1.03	2.04	4.04	8.19
2700	1.84	0.53	1.03	2.04	4.04	8.22
2800	1.86	0.53	1.02	2.04	4.04	8.24
2900	1.87	0.53	1.02	2.04	4.04	8.26
3000	1.87	0.52	1.01	2.03	4.03	8.28
3200	1.85	0.51	1.00	2.01	4.00	8.29
3400	1.90	0.50	0.98	2.00	3.98	8.30
3600	1.96	0.50	0.98	2.00	3.98	8.32
3800	2.04	0.50	0.98	2.01	3.98	8.33
4000	2.12	0.50	0.98	2.02	3.98	8.33
4200	2.18	0.51	0.99	2.03	3.98	8.35
4400	2.24	0.52	1.01	2.05	4.01	8.45
4600	2.28	0.53	1.03	2.09	4.08	8.66
4800	2.31	0.54	1.05	2.13	4.15	8.90
5000	2.39	0.55	1.07	2.17	4.22	9.16

* Step Attenuation above Thru Loss (TTL Logic 00000).



REV. A
DAT-15R5A-SP+
6/13/2016
7 of 9

P.O. Box 350166, Brooklyn, New York 11235-0003 (718) 934-4500 • Fax (718) 332-4661 For detailed performance specs & shopping online see Mini-Circuits web site
The Design Engineers Search Engine Provides ACTUAL Data Instantly From MINI-CIRCUITS At: www.minicircuits.com



Digital Step Attenuator **DAT-15R5A-SP+**

Typical Performance Data

TEST CONDITIONS: INPUT POWER=0 dBm, Vdd=+3V, TEMPERATURE=+105°C

FREQUENCY (MHz)	INPUT RETURN LOSS AT TTL CONTROL STATE (dB)					
	000000	000001	000010	000100	001000	010000
	0 dB	0.5 dB	1.0 dB	2.0 dB	4.0 dB	8.0 dB
0.1	16.94	17.70	18.37	16.39	16.18	16.81
0.3	17.06	17.81	18.48	16.48	16.28	16.88
0.5	17.07	17.81	18.47	16.48	16.28	16.89
1	17.14	17.88	18.54	16.53	16.30	16.89
5	17.13	17.88	18.55	16.52	16.30	16.90
10	17.13	17.89	18.55	16.53	16.31	16.90
50	17.23	18.00	18.69	16.66	16.46	17.08
100	17.44	18.25	18.97	16.92	16.73	17.42
200	17.23	18.04	18.75	16.80	16.67	17.35
300	16.81	17.51	18.13	16.28	16.06	16.58
400	16.91	17.56	18.13	16.20	15.88	16.26
500	16.99	17.62	18.15	16.16	15.76	16.04
600	16.86	17.43	17.90	15.90	15.43	15.61
700	16.88	17.39	17.81	15.75	15.20	15.30
800	17.09	17.54	17.91	15.78	15.14	15.17
900	17.10	17.50	17.82	15.71	15.04	15.03
1000	16.90	17.24	17.52	15.52	14.87	14.86
1100	16.66	16.96	17.21	15.41	14.82	14.86
1200	16.42	16.70	16.94	15.36	14.85	14.97
1300	15.94	16.22	16.45	15.16	14.79	15.04
1400	15.36	15.64	15.87	14.90	14.70	15.12
1500	14.83	15.11	15.35	14.69	14.68	15.32
1600	14.44	14.74	14.99	14.58	14.76	15.64
1700	14.10	14.41	14.67	14.46	14.82	15.95
1800	13.83	14.15	14.41	14.40	14.94	16.34
1900	13.70	14.03	14.28	14.46	15.16	16.88
2000	13.77	14.09	14.33	14.68	15.55	17.61
2100	13.96	14.29	14.51	15.01	16.04	18.49
2200	14.27	14.60	14.80	15.43	16.60	19.44
2300	14.80	15.12	15.28	16.06	17.35	20.62
2400	15.64	15.95	16.06	17.02	18.49	22.37
2500	16.91	17.20	17.23	18.39	20.05	24.73
2600	18.35	18.63	18.56	19.95	21.85	27.45
2700	20.17	20.40	20.14	21.88	24.02	30.03
2800	22.62	22.74	22.16	24.52	27.09	31.04
2900	26.77	26.73	25.38	29.27	32.89	29.34
3000	31.07	31.70	29.04	35.50	43.17	27.78
3200	33.47	48.11	38.23	37.36	35.84	25.78
3400	31.09	38.91	48.96	32.36	32.26	26.05
3600	27.42	29.40	29.82	27.49	28.74	29.46
3800	22.22	22.53	22.41	22.43	23.69	29.88
4000	18.20	18.28	18.17	18.69	19.86	24.73
4200	15.55	15.57	15.44	16.24	17.37	21.18
4400	13.86	13.86	13.70	14.64	15.69	18.64
4600	13.60	13.58	13.35	14.46	15.49	17.99
4800	14.34	14.24	13.86	15.21	16.16	17.99
5000	16.62	16.21	15.46	17.20	17.74	17.79

Digital Step Attenuator **DAT-15R5A-SP+**

Typical Performance Data

TEST CONDITIONS: INPUT POWER=0 dBm, Vdd=+3V, TEMPERATURE=+105°C

FREQUENCY (MHz)	OUTPUT RETURN LOSS AT TTL CONTROL STATE (dB)					
	000000	000001	000010	000100	001000	010000
	0 dB	0.5 dB	1.0 dB	2.0 dB	4.0 dB	8.0 dB
0.1	16.70	16.77	16.57	19.04	19.61	19.49
0.3	16.82	16.88	16.67	19.13	19.67	19.53
0.5	16.88	16.93	16.71	19.16	19.70	19.55
1	16.93	16.99	16.76	19.22	19.73	19.55
5	17.01	17.06	16.83	19.29	19.78	19.59
10	17.02	17.07	16.84	19.31	19.79	19.60
50	17.06	17.12	16.90	19.40	19.93	19.78
100	17.16	17.25	17.05	19.62	20.22	20.13
200	17.14	17.25	17.07	19.62	20.23	20.14
300	16.94	17.00	16.78	19.09	19.51	19.23
400	16.85	16.86	16.61	18.76	19.02	18.59
500	16.78	16.75	16.47	18.53	18.68	18.17
600	17.00	16.91	16.57	18.55	18.53	17.87
700	17.20	17.04	16.63	18.51	18.30	17.52
800	17.27	17.04	16.60	18.35	18.01	17.19
900	17.24	16.97	16.50	18.13	17.73	16.93
1000	17.19	16.87	16.41	17.89	17.47	16.74
1100	16.84	16.55	16.14	17.47	17.13	16.58
1200	16.37	16.13	15.80	17.00	16.80	16.50
1300	15.82	15.65	15.41	16.49	16.45	16.45
1400	15.21	15.12	14.97	15.94	16.07	16.40
1500	14.59	14.57	14.51	15.39	15.69	16.39
1600	14.08	14.12	14.14	14.95	15.41	16.47
1700	13.73	13.82	13.90	14.64	15.22	16.62
1800	13.41	13.54	13.68	14.36	15.04	16.77
1900	13.17	13.33	13.51	14.13	14.88	16.93
2000	13.08	13.28	13.49	14.06	14.86	17.20
2100	13.16	13.37	13.60	14.12	14.95	17.56
2200	13.42	13.65	13.90	14.35	15.21	18.10
2300	13.84	14.09	14.36	14.73	15.59	18.77
2400	14.50	14.76	15.04	15.34	16.18	19.67
2500	15.41	15.69	15.98	16.19	17.00	20.85
2600	16.62	16.90	17.20	17.30	18.03	22.29
2700	17.92	18.23	18.53	18.61	19.28	24.07
2800	19.50	19.86	20.17	20.34	20.94	26.48
2900	21.11	21.57	21.89	22.56	23.07	29.65
3000	22.60	23.19	23.49	25.54	26.00	33.46
3200	22.11	22.76	22.92	30.44	33.66	31.04
3400	20.02	20.49	20.53	26.63	28.95	25.66
3600	19.35	19.64	19.54	24.25	25.14	23.55
3800	19.89	19.95	19.71	23.51	23.61	23.61
4000	20.45	20.26	20.02	22.15	22.08	25.20
4200	19.46	19.29	19.31	19.75	20.04	26.60
4400	17.95	17.94	18.17	17.57	18.07	24.46
4600	17.51	17.59	17.87	16.46	16.90	21.32
4800	18.17	18.27	18.55	16.17	16.42	18.87
5000	20.43	20.38	20.50	16.63	16.49	16.90



REV. A
 DAT-15R5A-SP+
 6/13/2016
 9 of 9

P.O. Box 350166, Brooklyn, New York 11235-0003 (718) 934-4500 • Fax (718) 332-4661 For detailed performance specs & shopping online see Mini-Circuits web site
 The Design Engineers Search Engine Provides ACTUAL Data Instantly From MINI-CIRCUITS At: www.minicircuits.com

Digital Step Attenuator

Typical Performance Curves

DAT-15R5A-SP+

Thru Loss

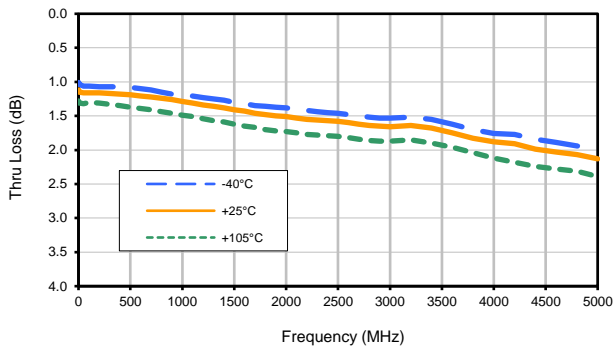

Step Attenuation (0.5dB)

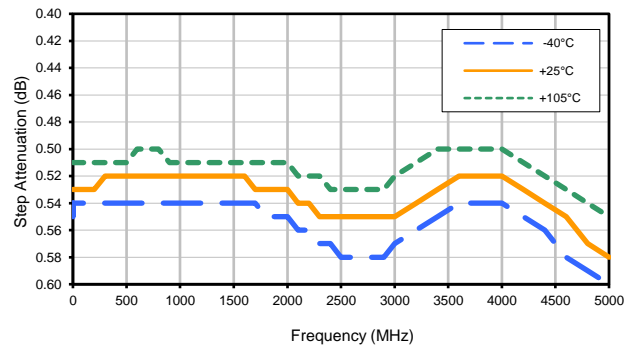

Step Attenuation (1dB)

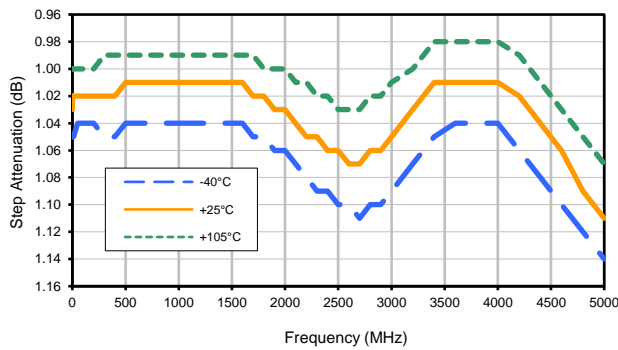

Step Attenuation (2dB)

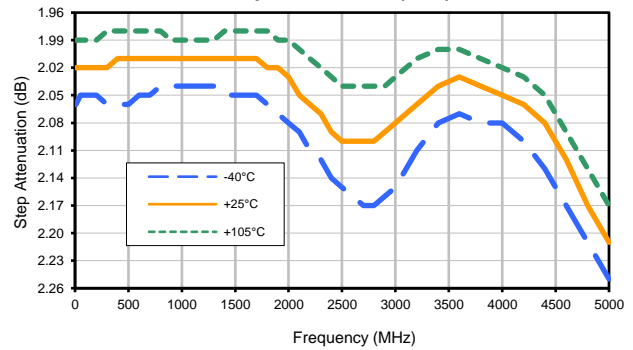

Step Attenuation (4dB)

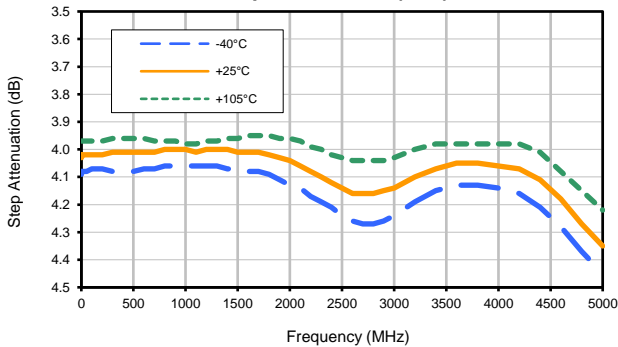

Step Attenuation (8dB)

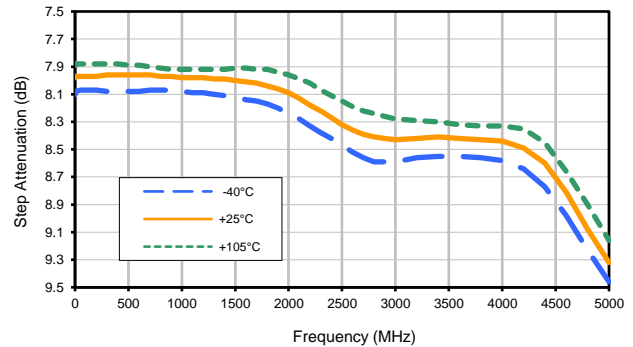

Digital Step Attenuator

Typical Performance Curves

DAT-15R5A-SP+

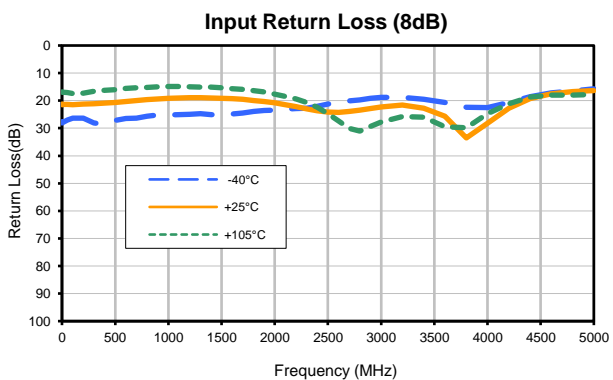
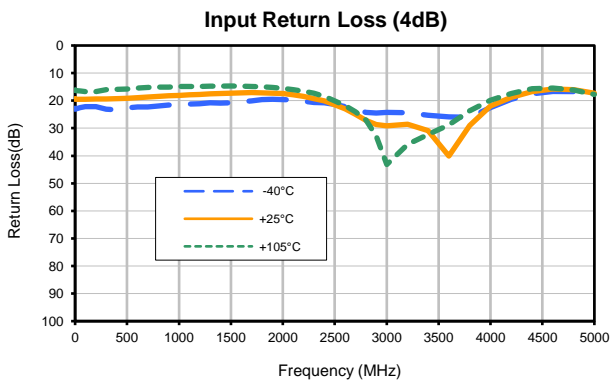
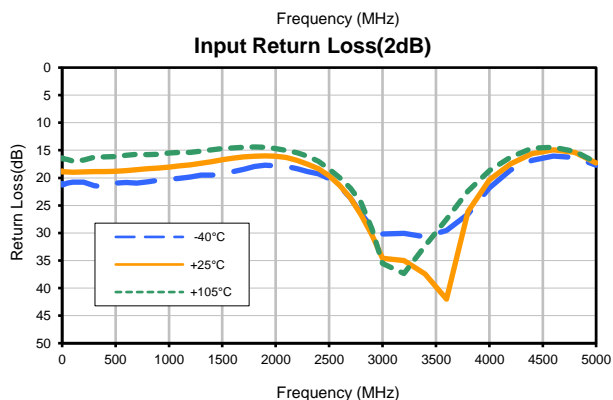
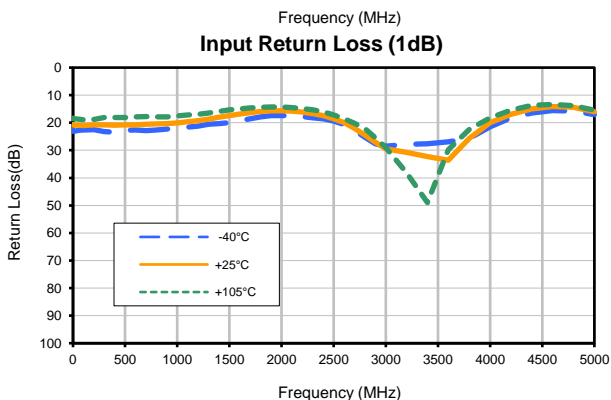
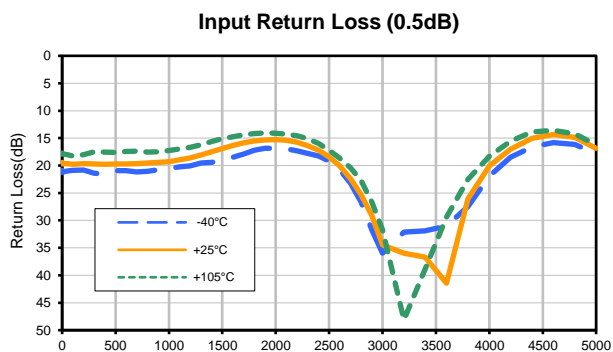
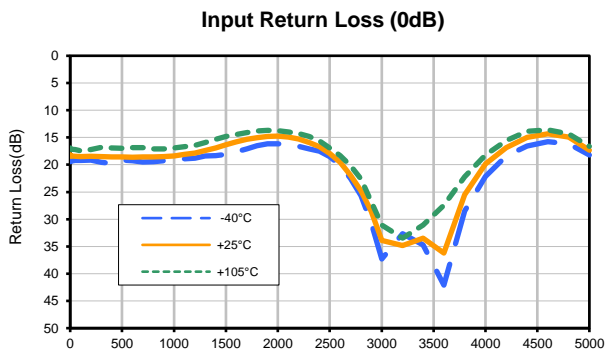

ISO 9001 ISO 14001 AS 9100 CERTIFIED



REV. A
 DAT-15R5A-SP+
 6/13/2016
 2 of 3

P.O. Box 350166, Brooklyn, New York 11235-0003 (718) 934-4500 • Fax (718) 332-4661 For detailed performance specs & shopping online see Mini-Circuits web site
 The Design Engineers Search Engine Provides ACTUAL Data Instantly From MINI-CIRCUITS At: www.minicircuits.com

IF/RF MICROWAVE COMPONENTS

Digital Step Attenuator

Typical Performance Curves

DAT-15R5A-SP+

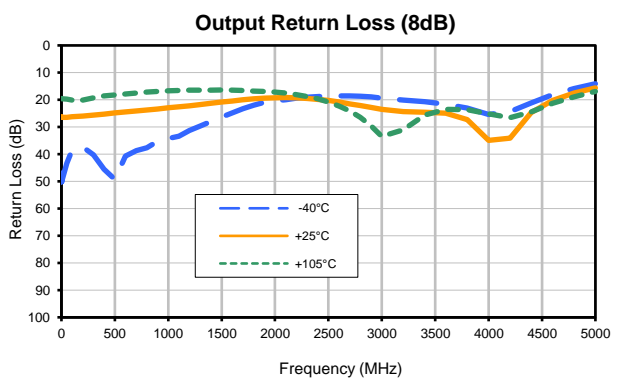
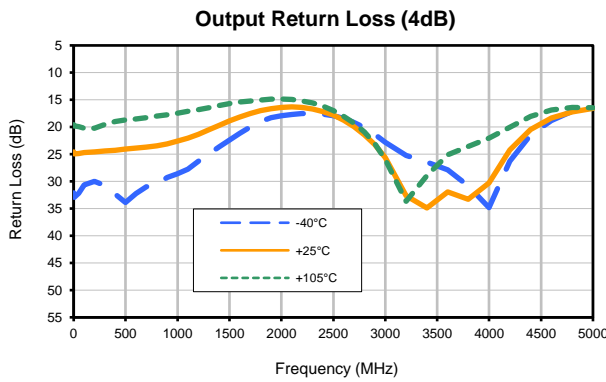
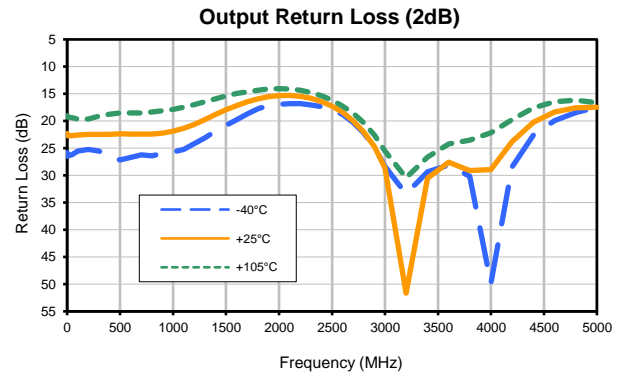
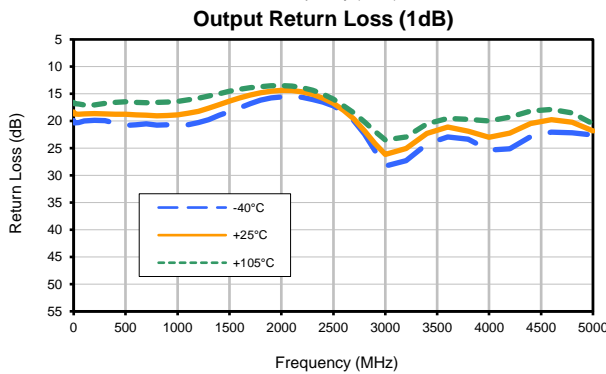
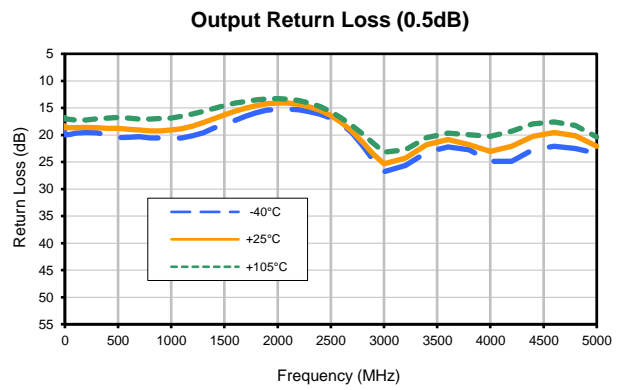
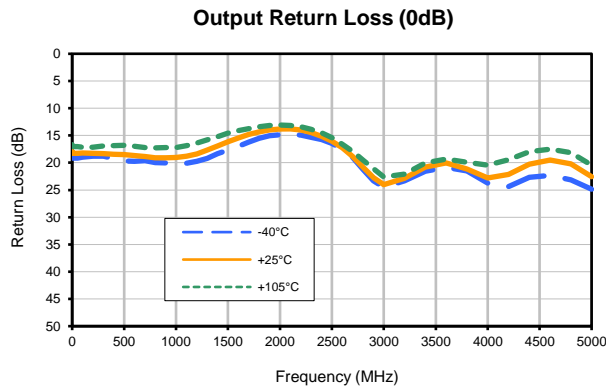

Outline Dimensions

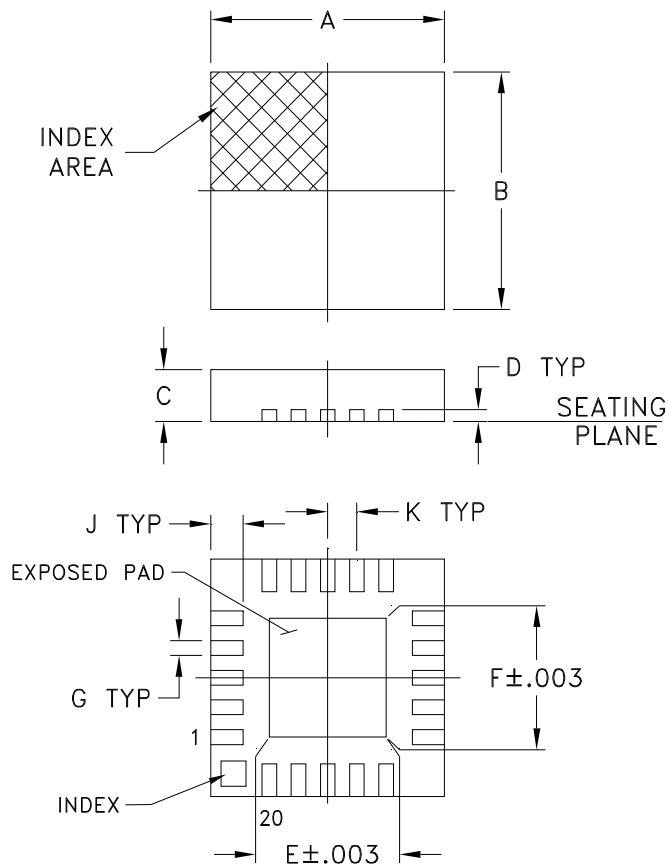

PCB Land Pattern

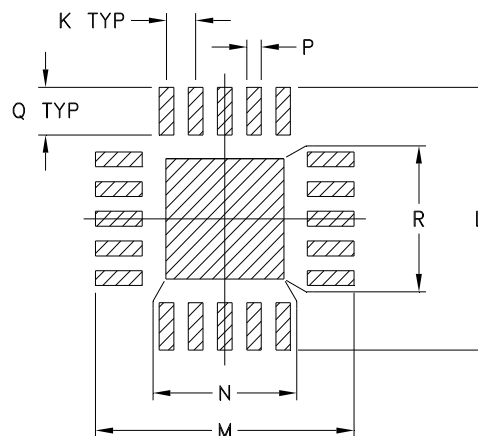

Suggested Layout,
Tolerance to be within $\pm .002$

CASE #	A	B	C	D	E	F	G	H	J	K
DG983-2	.157 (4.00)	.157 (4.00)	.033 (0.85)	.008 (0.20)	.085 (2.15)	.085 (2.15)	.009 (0.23)	-- --	.022 (0.55)	.020 (0.50)

CASE #	L	M	N	P	Q	R	WT. GRAM
DG983-2	.177 (4.50)	.177 (4.50)	.081 (2.06)	.010 (0.25)	.032 (0.81)	.081 (2.06)	.04

Dimensions are in inches (mm). Tolerances: 2 Pl. $\pm .01$; 3 Pl. $\pm .005$

Notes:

1. Case material: Plastic.
2. Termination finish:

For RoHS Case Styles: 0.2 μ inches of Gold (Au) over 0.1 μ inches of Palladium (Pd) over 10 μ inches of Nickel (Ni). All models, (+) suffix.

For RoHS-5 Case Styles: Tin-Lead plate. All models, no (+) suffix.



Tape & Reel Packaging TR-F87

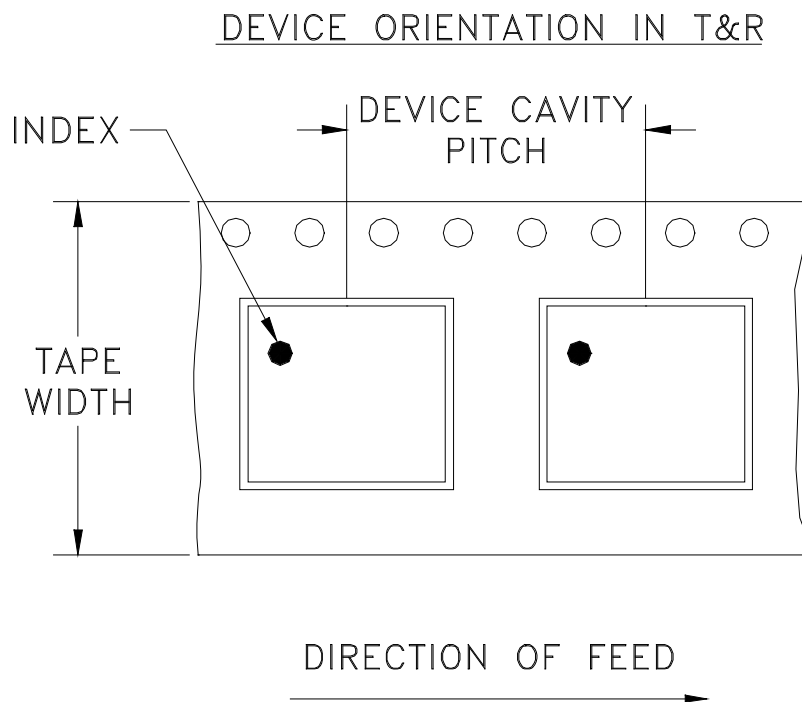

Tape Width, mm	Device Cavity Pitch, mm	Reel Size, inches	Devices per Reel	
12	8	7	Small quantity standards (see note)	20
				50
				100
				200
				500
		1000		
		13	Standard	3000

Note : Please Consult individual model data sheet to determine device per reel availability

Mini-Circuits carrier tape materials provide protection from ESD (Electro-Static Discharge) during handling and transportation. Tapes are static dissipative and comply with industry standards EIA-481/EIA-541.

Go to: www.minicircuits.com/pages/pdfs/tape.pdf



INTERNET <http://www.minicircuits.com>

P.O. Box 350166, Brooklyn, New York 11235-0003 (718) 934-4500 Fax (718) 332-4661

Distribution Centers NORTH AMERICA 800-654-7949 • 417-335-5935 • Fax 417-335-5945 • EUROPE 44-1252-832600 • Fax 44-1252-837010

Mini-Circuits ISO 9001 & ISO 14001 Certified

THIRD ANGLE PROJECTION

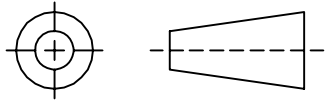

REVISIONS

REV	ECN No.	DESCRIPTION	DATE	DR	AUTH
OR	M97254	NEW RELEASE (FROM RAVON)	03/05	DK	HH
A	M102713	MODIFIED HATCH, NOTES & ADDED "...WITH SMOBC"	01/06	GT	IL
B	M103510	ADD R7 & CHANGE LOCATION DESIGNATORS	07/09	EM	KN
B	R63339	ADD R7 & CHANGE LOCATION DESIGNATORS	07/09	EM	KN

SUGGESTED MOUNTING CONFIGURATION

FOR DG983-1 CASE STYLE, qm PIN CONNECTION, 50 Ω.

KEEP-OUT ZONE,
.025 X.025, AVOID
TRACES IN THIS AREA
TO PREVENT SHORT TO
METAL INDEX ON BOTTOM
SIDE OF COMPONENT

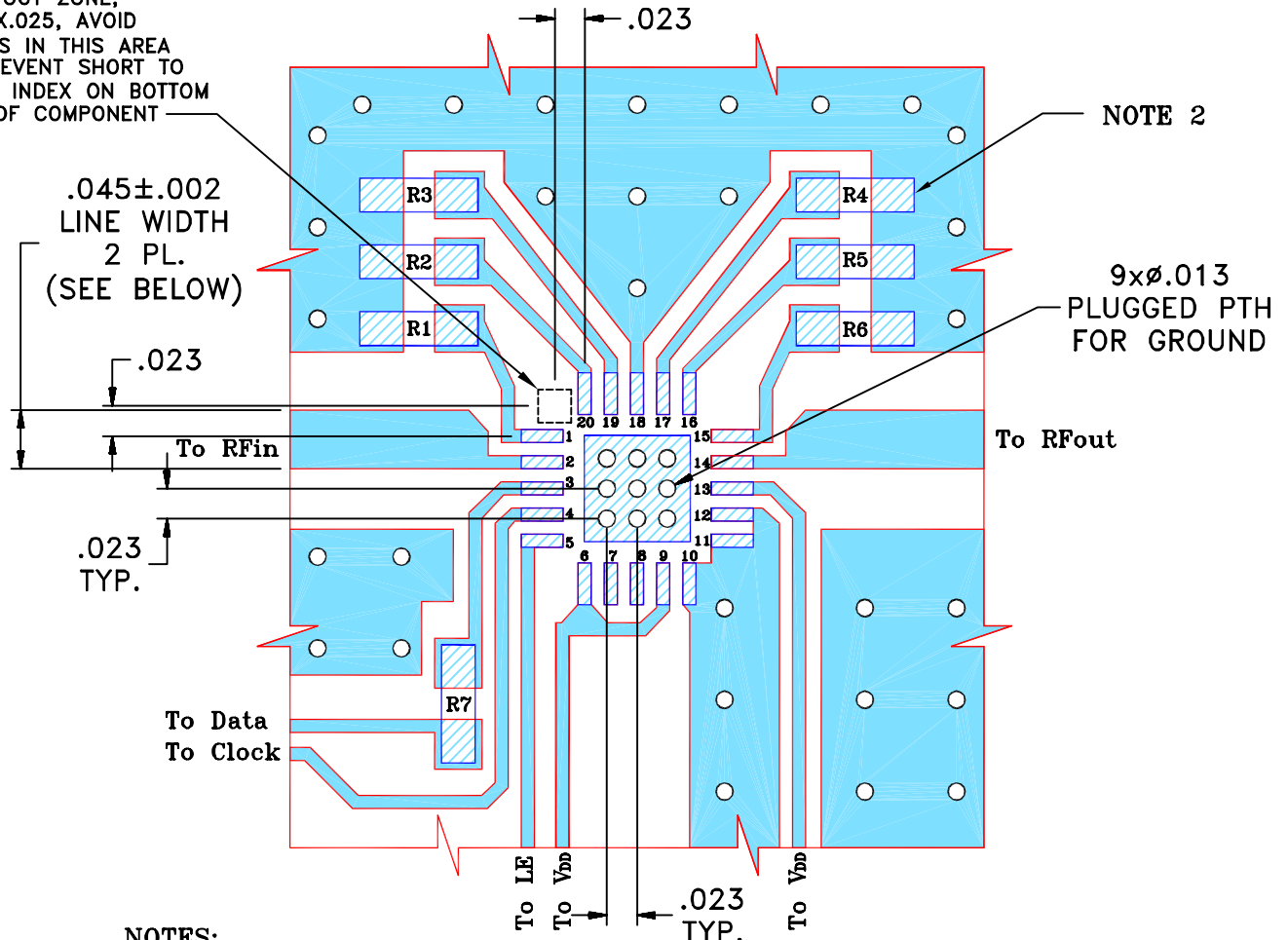

NOTES:

- TRACE WIDTH IS SHOWN FOR FR4 WITH DIELECTRIC THICKNESS .025"±.002". COPPER: 1/2 OZ. EACH SIDE. FOR OTHER MATERIALS TRACE WIDTH MAY NEED TO BE MODIFIED.
- 0603 SIZE CHIP FOOT PRINTS SHOWN FOR REFERENCE, VALUES OF RESISTORS WILL VARY BASED ON APPLICATION.
- BOTTOM SIDE OF THE PCB IS CONTINUOUS GROUND PLANE.



DENOTES PCB COPPER LAYOUT WITH SMOBC (SOLDER MASK OVER BARE COPPER)



DENOTES COPPER LAND PATTERN FREE OF SOLDER MASK

UNLESS OTHERWISE SPECIFIED

DIMENSIONS ARE IN INCHES
TOLERANCES ON:
2 PL DECIMALS ±
3 PL DECIMALS ± .005
ANGLES ±
FRACTIONS ±

	INITIALS	DATE
DRAWN	DK (RAVON)	08 MAR 05
CHECKED	RZ (RAVON)	08 MAR 05
APPROVED	HH (RAVON)	08 MAR 05



Mini-Circuits® 13 Neptune Avenue
Brooklyn NY 11235

PL, qm, DG983-1
TB-334 (50 Ω)

THIS DOCUMENT AND ITS CONTENTS ARE THE PROPERTY OF MINI-CIRCUITS. EXCEPT FOR USE EXPRESSLY GRANTED, IN WRITING, TO ITS VENDORS, VENDEE AND THE UNITED STATES GOVERNMENT, MINI-CIRCUITS RESERVES ALL PROPRIETARY DESIGN, USE, MANUFACTURING AND REPRODUCTION RIGHTS THERETO. THESE CONTENTS SHALL NOT BE USED, DUPLICATED OR DISCLOSED TO ANY OUTSIDE PARTY, IN WHOLE OR IN PART, WITHOUT WRITTEN PERMISSION OF MINI-CIRCUITS.

SIZE A	CODE IDENT 15542	DRAWING NO: 98-PL-199	REV: B
FILE: 98PL199	SCALE: 7:1	SHEET: 1 OF 1	

Evaluation Board and Circuit

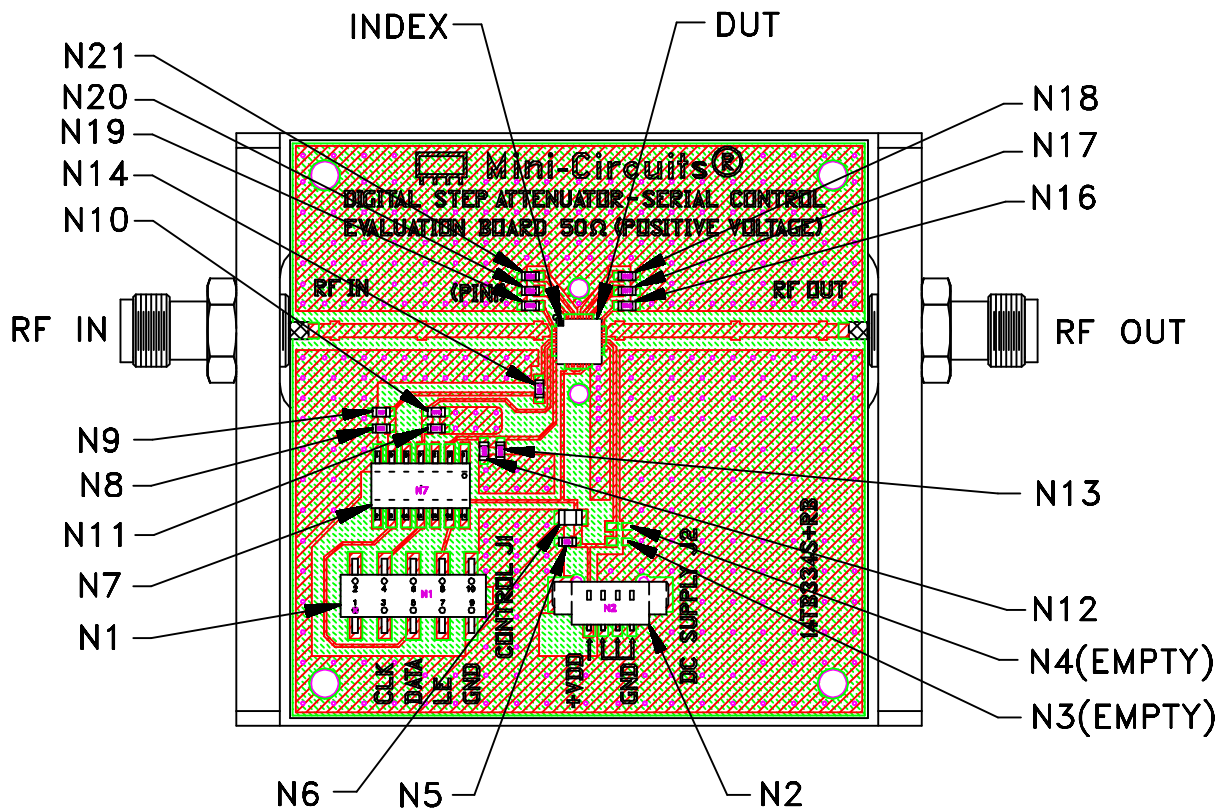

TB-334

Notes:

1. N-Type Female connectors.
2. PCB Material: FR4 Grade IT 180TC (ITEQ Corporation) or equivalent, Dielectric Constant=4.7, Thickness=.025 inch.

 **Mini-Circuits®**

All Mini-Circuits products are manufactured under exacting quality assurance and control standards, and are capable of meeting published specifications after being subjected to any or all of the following physical and environmental test.

Specification	Test/Inspection Condition	Reference/Spec
Operating Temperature	-40° to 85° C or -40° to 105° C Ambient Environment	Refer to Individual Model Data Sheet
Storage Temperature	-55° to 100° C or -65° to 150° C Ambient Environment	Refer to Individual Model Data Sheet
Temperature Humidity Bias	85°C, 85% RH, 96 hours	JESD22-A101B
Thermal Shock	-55° to 100°C, 100 cycles	MIL-STD-202, Method 107, Condition A-3, except +100°C
Solder Reflow Heat	Pb-Free Process: 260°C peak	J-STD-020, Table 4-1, 4-2 and 5-2; Figure 5-1
Solderability	10X magnification, 95% coverage	JESD22-B102, Method 1: Dip and Look Test
Marking Resistance to Solvents	Laser marked, visual observation	Mini-Circuits D4-Q4T0-04