



BVU-539QG9

PACKAGE CONFIGURATION

DESCRIPTION

Dice Material : AlGaInP Orange Red
Light Color : Orange Red Color
Lens Color : Red Tinted Diffused
Stand-Off P/N : BVU-539QG9 R

RADIATION PATTERN

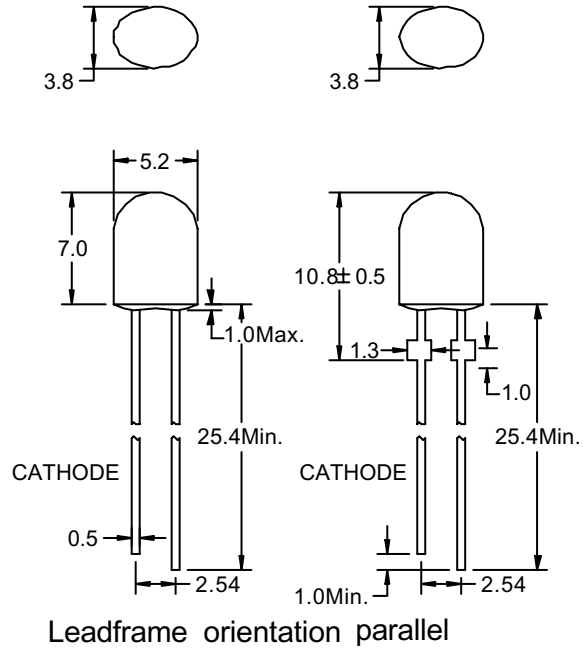
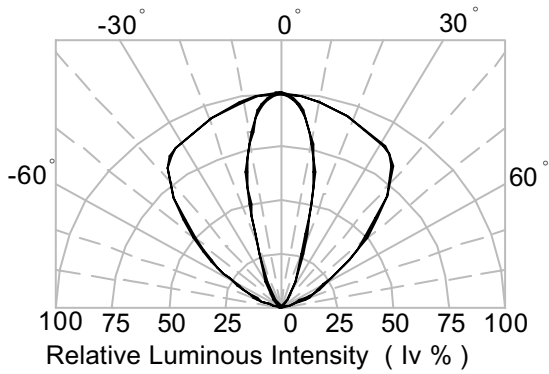

Tolerance ± 0.25 mm

ABSOLUTE MAXIMUM RATINGS AT Ta = 25 °C

| PARAMETER | MAX. | UNIT |
|--|----------------------|-------|
| Power Dissipation | 80 | mW |
| Continuous Forward Current | 30 | mA |
| Peak Forward Current (1/10 Duty Cycle , 0.1ms Pulse Width) | 160 | mA |
| Reverse Voltage | 5 | V |
| Derating Linear From 50 °C | 0.4 | mA/°C |
| Operating Temperature Range | - 40 °C to + 100 °C | |
| Storage Temperature Range | - 40 °C to + 100 °C | |
| Lead Solder Temperature 1.6 mm Below Package | 260 °C for 5 seconds | |

ELECTRICAL / OPTICAL CHARACTERISTICS AT Ta = 25 °C

| SYMBOL | PARAMETER | TEST COND. | MIN. | TYP. | MAX. | UNIT |
|--------|--------------------------|-------------|------|--------|------|------|
| V F | Forward Voltage | I F = 20 mA | | 2.2 | 2.7 | V |
| I R | Reverse Current | V R = 5V | | | 100 | μ A |
| λ p | Peak Emission Wavelength | I F = 20 mA | | 630 | | n m |
| λ d | Dominant Wavelength | I F = 20 mA | | 625 | | n m |
| 2θ 1/2 | Viewing Angle | I F = 20 mA | | 100/30 | | Deg |

BIN GRADE LIMITS (I F = 20 mA) LUMINOUS INTENSITY / mcd

| Bin | H | I | J | K | L | M |
|------|-----|------|------|------|------|------|
| Min. | 600 | 780 | 1000 | 1300 | 1680 | 2180 |
| Max. | 780 | 1000 | 1300 | 1680 | 2180 | 2800 |

Tolerance ± 15% mcd

*Bright View reserves the rights to alter specifications and remove availability of products at any time without notice.

*Dominant Wavelength, λ d is according to CIE Chromaticity Diagram base on color of lamps.

*θ 1/2 is the off-axis angle where the luminous intensity is one half the on-axis intensity.



AlGaInP LED

TYPICAL ELECTRICAL/OPTICAL CHARACTERISTIC CURVES

FIG. 1 Forward Current Vs. Forward Voltage

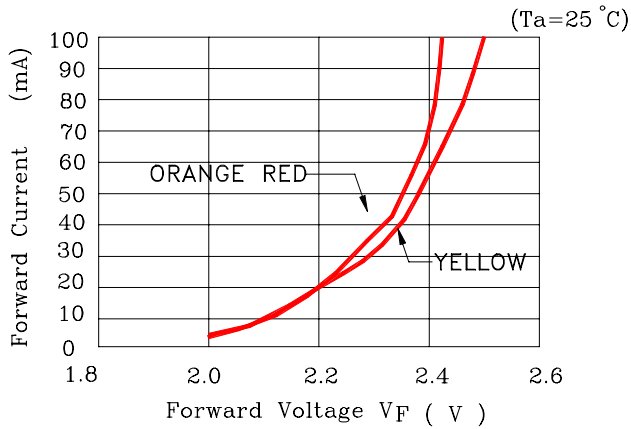

FIG. 2 Relative Intensity Vs. Forward Current

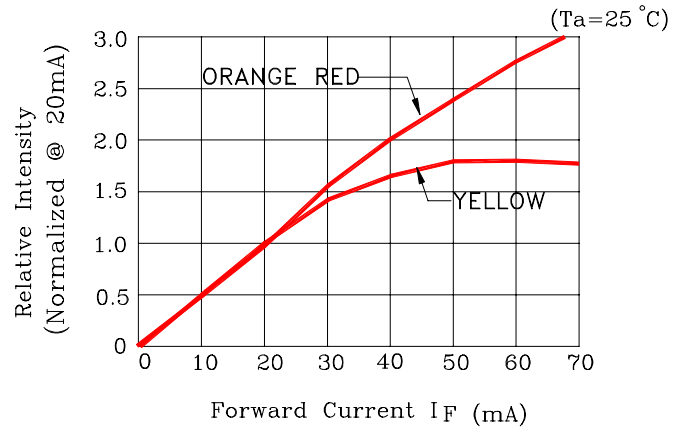

FIG. 3 Forward Voltage VS. Temperature

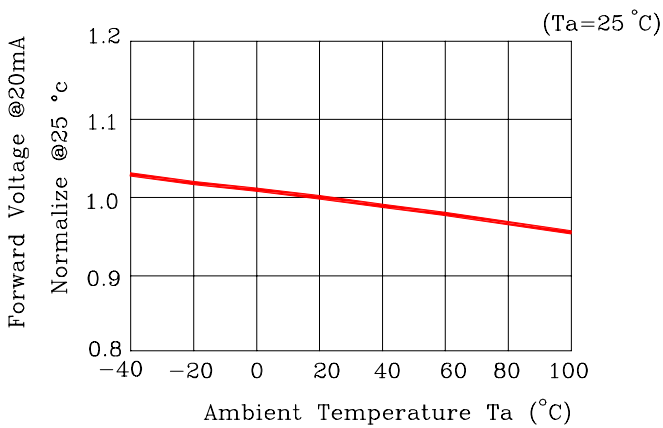

FIG. 4 Relative Intensity vs. Temperature

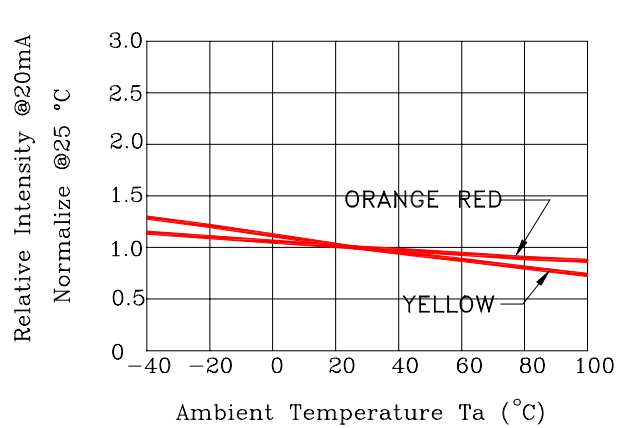

FIG. 5 Relative Intensity vs. Wavelength (λ_p)

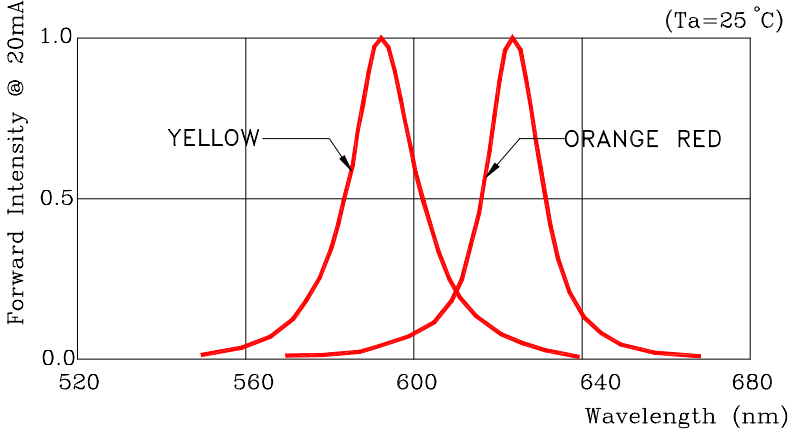
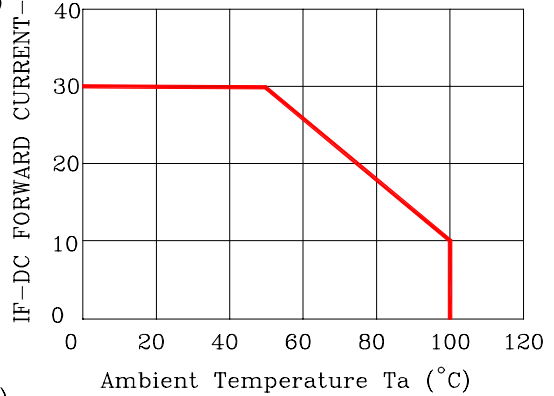

FIG. 6 Maximum Forward Current vs. Ambient Temperature. Derating Based on $T_{MAX}=130^{\circ}C$





LAMP PACKING



| Device | Q'ty / Polybag (pcs) | Polybag / Box A | Fig. |
|----------------------|----------------------|-----------------|---------|
| 5mm(T-1 3/4) | 1000pcs | 14 bags | Label 1 |
| 3mm(T-1) | 1000pcs | 20 bags | Label 1 |
| Blue / Green / White | 500pcs | 18 bags | Label 2 |

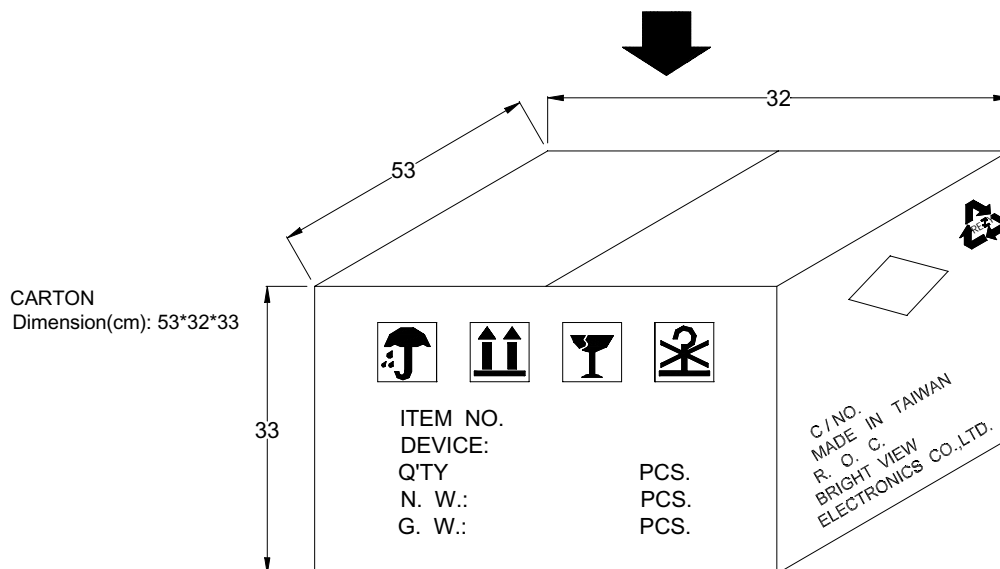

4 Boxes / Carton

5mm : 56,000pcs

3mm : 80,000pcs

Blue / Green / White : 36,000pcs