

High IP3 Monolithic Amplifier

HELA-10+

Broadband, 50&75 ohms 5 to 1000 MHz



Maximum Ratings

Heat Slug Temperature	110°C
Storage Temperature	-40°C to +125°C
DC Voltage	+13V
DC Power	7.15W

Pin Connections

RF IN 1,2	3,6
RF OUT 1,2	14,11
DC	10,15
GROUND	1,4,5,8,9,12,13,16
NO CONNECTION	2,7*

*Adding bias resistors may improve IP3, IP2.
See Application Notes:
Enhanced linearity in the HELA-10 Power Amplifier (AN60-009)

High IP3, wideband, balanced linear amplifier
HELA-10 (AN60-0033)

Outline Drawing

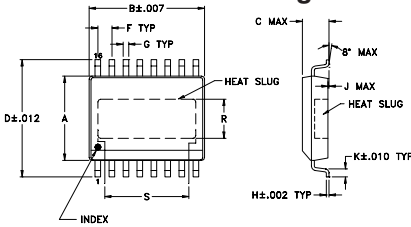

PCB Land Pattern

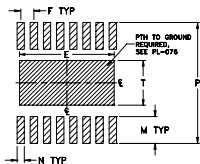

Suggested Layout,
Tolerance to be within ±.002

Outline Dimensions (inch/mm)

A	B	C	D	E	F	G	H	J
.295	.405	.098	.406	.360	.050	.016	.008	.004
7.49	10.29	2.49	10.31	9.14	1.27	0.41	0.20	0.10
K	L	M	N	P	R	S	T	wt
.032	--	.102	.028	.460	.13	.34	.170	grams
0.81	--	2.59	0.71	11.68	3.30	8.64	4.32	0.67

Demo Board MCL P/N: TB-16,-17,-30,-45 Suggested PCB Layout (PL-076)

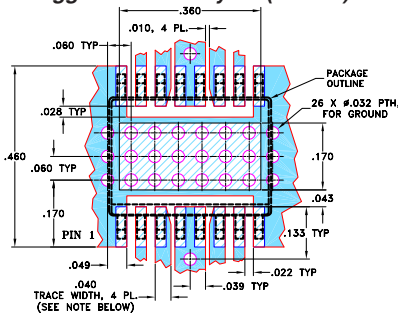

NOTE: 1. TRACE WIDTH IS SHOWN FOR FR4 WITH DIELECTRIC THICKNESS 0.057" ± .002"; COPPER: 1/2 OZ. EACH SIDE. FOR OTHER MATERIALS TRACE WIDTH MAY NEED TO BE MODIFIED.
2. BOTTOM SIDE OF THE PCB IS CONTINUOUS GROUND PLANE.

- DENOTES PCB COPPER LAYOUT WITH SMOBC (SOLDER MASK OVER BARE COPPER)
- DENOTES COPPER LAND PATTERN FREE OF SOLDER MASK

Notes

- Performance and quality attributes and conditions not expressly stated in this specification document are intended to be excluded and do not form a part of this specification document.
- Electrical specifications and performance data contained in this specification document are based on Mini-Circuits' applicable established test performance criteria and measurement instructions.
- The parts covered by this specification document are subject to Mini-Circuits' standard limited warranty and terms and conditions (collectively, "Standard Terms"); Purchasers of this part are entitled to the rights and benefits contained therein. For a full statement of the Standard Terms and the exclusive rights and remedies thereunder, please visit Mini-Circuits' website at www.minicircuits.com/MCLStore/terms.jsp

Features

- excellent flatness, ±0.4 dB typ.
- very high IP3, 49 dBm typ. at 150 MHz & 45 dBm typ. at 800 MHz
- very high IP2, 88 dBm typ.
- low noise figure, 3.5 dB typ.
- aqueous washable

Applications

- Cellular
- Catv
- Instrumentation

CASE STYLE: CM624

Model
HELA-10+
HELA Kit (see table below)

+RoHS Compliant
The +Suffix identifies RoHS Compliance. See our web site for RoHS Compliance methodologies and qualifications

Electrical Specifications at 25°C

KIT ¹ NO.	FREQ. (MHz)	OHMS	GAIN ² (dB)				MAXIMUM POWER (dBm)			DYNAMIC RANGE		VSWR ⁴ (:1)		DC POWER		THERMAL RESISTANCE ⁵ θjc °C/W
			Min.	Typ.	Max.	Flatness	Output (1 dB Compr.)	Input ³ (no damage)	NF (dB)	IP3 (dBm)	IN	OUT	Nom.	Max.		
HELA-10A+	50-1000	75	9.5	12	13	±0.4	30	26	20	3.5	47	1.22	1.22	12	525	6
HELA-10B+	50-1000	50	9.5	12	13	±0.4	30	26	20	3.5	47	1.22	1.22	12	525	6
HELA-10C+	5-450	75	9.3	11.4	12.5	±0.4	30	26	20	3.5	48	1.3	1.22	12	525	6
HELA-10D+	8-300	50	9.3	11	12.5	±0.4	30	26	20	3.5	48	1.2	1.2	12	525	6

1. Kit consists of HELA-10 plus transformers, see table below.
2. Includes transformer losses at input & output.
3. Open load is not recommended, potentially can cause damage. With no load, derate max. input power by 20 dB.
4. For 75 ohm. For 50 ohm, VSWR increases from 1.2:1 at 1 GHz to 2.0:1 at 50MHz.
5. Thermal resistance is from junction to heat slug. (mounting paddle).

Application Schematic Diagram

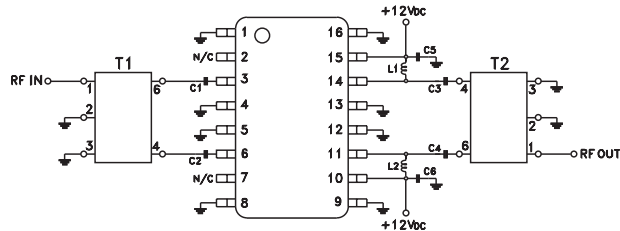

APPLICATION CIRCUIT	T1	T2	C1 TO C6	L1, L2	PCB LAYOUT	EVALUATION BOARD
A	ADTL1-18-75	ADTL1-18-75	0.01µF	0.75µH	B14-TB-30	TB-16
B	ADTL1-12	ADTL1-12	0.01µF	0.75µH	B14-TB-17	TB-17
C	ADT1-1WT	ADTL1-4-75	0.039µF	3.3µH	B14-TB-16	TB-30
D	ADT1-5-1	ADT1-5-1	0.039µF	3.3µH	B14-TB-17	TB-45

Assembly Guideline

Reflow solder the slug to the ground plane; PC board layouts for 75 ohm (B14-TB-16), (B14-TB-30), and for 50 ohm (B14-TB-17) are available upon request. Please contact Applications Department or consult our web site.

Amplifier

HELA-10A+

Typical Performance Data

FREQUENCY (MHz)	GAIN (dB) 12V	DIRECTIVITY (dB) 12V	VSWR IN (:1) 12V	VSWR OUT (:1) 12V	Output IP3 (dBm) 12V	NOISE FIGURE (dB) 12V	Pout at 1dB Comp. (dBm) 12V
25.0	11.42	5.45	1.40	1.25	47.32	4.97	29.62
50.0	11.53	5.35	1.22	1.12	50.41	3.40	29.95
75.0	11.55	5.35	1.17	1.09	51.35	3.11	30.06
100.0	11.55	5.34	1.15	1.07	48.17	2.99	30.11
200.0	11.48	5.55	1.13	1.10	47.74	2.97	30.32
300.0	11.39	5.79	1.10	1.16	47.94	3.02	30.59
400.0	11.37	5.94	1.10	1.16	51.73	3.08	30.74
500.0	11.36	6.13	1.15	1.08	51.38	3.15	30.80
600.0	11.32	6.48	1.18	1.08	52.30	3.27	30.57
700.0	11.21	6.85	1.15	1.19	50.93	3.35	30.09
800.0	10.97	7.45	1.05	1.23	51.14	3.48	29.58
900.0	10.87	7.85	1.16	1.27	49.68	3.61	29.26
1000.0	10.39	8.98	1.50	1.40	49.64	3.77	28.93

REV. X1
HELA-10A+
071217
Page 1 of 4



IF/RF MICROWAVE COMPONENTS • ISO 9001 ISO 14001 AS 9100 CERTIFIED RoHS compliant
P.O. Box 350166, Brooklyn, New York 11235-0003 (718) 934-4500 Fax (718) 332-4661



The Design Engineers Search Engine finds the model you need, Instantly • For detailed performance specs & shopping online see



Amplifier

HELA-10B+

Typical Performance Data

FREQUENCY (MHz)	GAIN (dB) 12V	DIRECTIVITY (dB) 12V	VSWR IN (:1) 12V	VSWR OUT (:1) 12V	Output IP3 (dBm) 12V	NOISE FIGURE (dB) 12V	Pout at 1dB Comp. (dBm) 12V
25.0	10.85	6.52	2.06	2.01	47.75	5.82	29.04
50.0	11.01	6.31	1.90	1.91	48.18	3.90	29.21
75.0	11.06	6.21	1.82	1.85	48.33	3.39	29.39
100.0	11.11	6.14	1.75	1.78	48.01	3.35	29.51
200.0	11.24	5.93	1.40	1.45	48.63	3.00	29.84
300.0	11.25	5.97	1.12	1.22	51.06	2.99	31.04
400.0	11.12	6.33	1.25	1.31	52.42	3.18	31.09
500.0	11.00	6.71	1.40	1.47	52.36	3.16	31.14
600.0	10.97	6.93	1.40	1.48	50.71	3.37	30.66
700.0	10.94	7.18	1.25	1.33	49.95	3.61	30.16
800.0	10.78	7.72	1.11	1.20	48.46	3.65	29.51
900.0	10.76	8.02	1.16	1.19	47.83	3.67	29.04
1000.0	10.66	8.53	1.23	1.24	47.03	3.77	28.41

REV. X1
HELA-10B+
071217
Page 2 of 4



IF/RF MICROWAVE COMPONENTS • ISO 9001 ISO 14001 AS 9100 CERTIFIED RoHS compliant

P.O. Box 350166, Brooklyn, New York 11235-0003 (718) 934-4500 Fax (718) 332-4661



The Design Engineers Search Engine finds the model you need, Instantly • For detailed performance specs & shopping online see



Amplifier

HELA-10C+

Typical Performance Data

FREQUENCY (MHz)	GAIN (dB) 12V	DIRECTIVITY (dB) 12V	VSWR IN (:1) 12V	VSWR OUT (:1) 12V	Output IP3 (dBm) 12V	NOISE FIGURE (dB) 12V	Pout at 1dB Comp. (dBm) 12V
3.0	9.75	3.91	3.13	1.97	47.17	-	28.66
4.0	10.67	3.62	2.50	1.59	48.48	-	29.07
5.0	11.06	3.79	2.14	1.42	48.90	-	29.59
6.0	11.26	3.99	1.93	1.33	49.49	-	29.70
7.0	11.37	4.21	1.80	1.27	50.24	-	29.84
8.0	11.44	4.35	1.70	1.24	49.99	-	29.96
9.0	11.48	4.49	1.63	1.21	51.10	-	30.07
10.0	11.50	4.62	1.58	1.19	50.49	9.12	30.23
100.0	11.38	5.65	1.37	1.13	47.90	3.12	30.57
200.0	11.12	6.11	1.41	1.12	47.48	3.17	30.44
300.0	10.92	6.57	1.42	1.11	46.65	3.28	30.16
400.0	10.73	6.91	1.41	1.25	49.23	3.47	30.27
425.0	10.65	7.09	1.43	1.32	49.49	3.54	30.18
450.0	10.51	7.26	1.47	1.38	50.05	3.60	30.16
475.0	10.38	7.57	1.54	1.47	52.52	3.65	30.14
500.0	10.25	7.81	1.64	1.56	49.34	3.73	30.11
525.0	10.10	8.15	1.76	1.66	49.48	3.85	30.11
550.0	9.95	8.43	1.90	1.74	49.42	3.91	30.08
575.0	9.79	8.87	2.07	1.83	50.70	4.06	29.99
600.0	9.63	9.28	2.28	1.91	50.22	4.16	29.93

REV. X1
HELA-10C+
071217
Page 3 of 4



IF/RF MICROWAVE COMPONENTS • ISO 9001 ISO 14001 AS 9100 CERTIFIED RoHS compliant
P.O. Box 350166, Brooklyn, New York 11235-0003 (718) 934-4500 Fax (718) 332-4661



The Design Engineers Search Engine finds the model you need, Instantly • For detailed performance specs & shopping online see



Amplifier

HELA-10D+

Typical Performance Data

FREQUENCY (MHz)	GAIN (dB) 12V	DIRECTIVITY (dB) 12V	VSWR IN (:1) 12V	VSWR OUT (:1) 12V	Output IP3 (dBm) 12V	NOISE FIGURE (dB) 12V	Pout at 1dB Comp. (dBm) 12V
8.0	11.02	5.35	1.61	1.17	49.55	9.45	30.33
9.0	11.08	5.42	1.53	1.14	50.52	9.45	30.47
10.0	11.12	5.47	1.46	1.12	50.32	9.45	30.64
20.0	11.23	5.76	1.20	1.04	54.14	5.71	30.67
40.0	11.20	5.96	1.09	1.02	49.97	3.90	30.66
60.0	11.15	6.08	1.07	1.04	50.12	3.33	30.60
80.0	11.11	6.18	1.09	1.07	50.40	3.34	30.56
100.0	11.06	6.27	1.12	1.11	50.12	3.31	30.43
120.0	11.02	6.37	1.17	1.16	50.40	3.16	30.35
140.0	10.97	6.48	1.22	1.21	52.09	3.29	30.29
160.0	10.91	6.59	1.28	1.27	51.37	3.28	30.25
180.0	10.85	6.73	1.35	1.34	51.53	3.23	30.28
200.0	10.77	6.89	1.43	1.42	50.23	3.39	30.48
220.0	10.68	7.09	1.52	1.50	51.43	3.47	30.46
240.0	10.58	7.31	1.61	1.59	53.43	3.40	30.45
260.0	10.45	7.58	1.71	1.70	53.36	3.57	30.37
280.0	10.33	7.84	1.81	1.80	52.58	3.72	30.42
300.0	10.21	8.10	1.93	1.90	50.64	3.67	30.32
400.0	9.43	9.74	2.46	2.44	52.58	3.97	30.04
450.0	9.07	10.54	2.68	2.65	52.11	4.01	29.79
500.0	8.76	11.22	2.84	2.78	51.68	4.18	29.46

REV. X1
HELA-10D+
071217
Page 4 of 4



IF/RF MICROWAVE COMPONENTS • ISO 9001 ISO 14001 AS 9100 CERTIFIED RoHS compliant
P.O. Box 350166, Brooklyn, New York 11235-0003 (718) 934-4500 Fax (718) 332-4661



The Design Engineers Search Engine finds the model you need, Instantly • For detailed performance specs & shopping online see



Typical Performance Curves

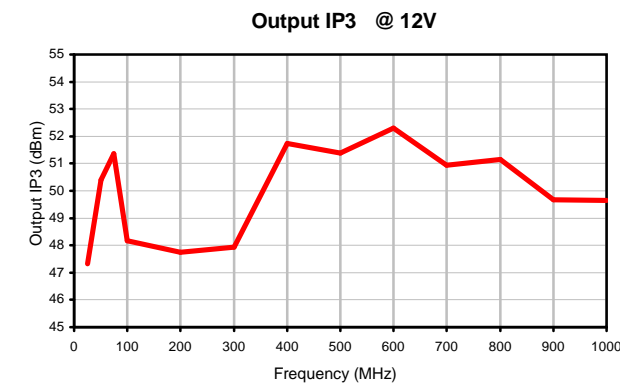
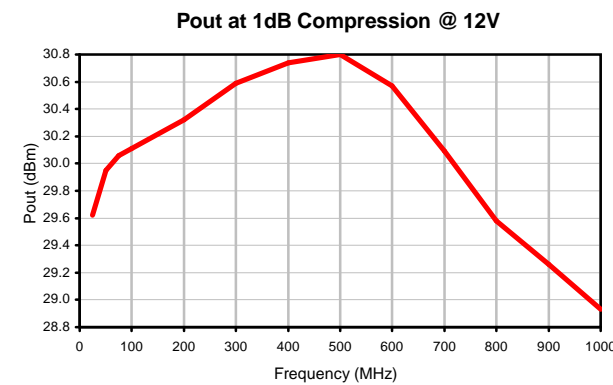
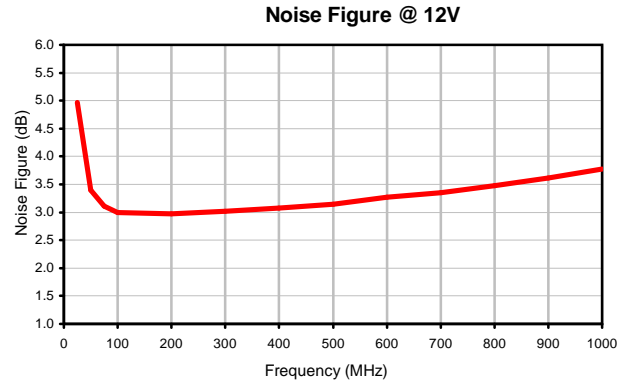
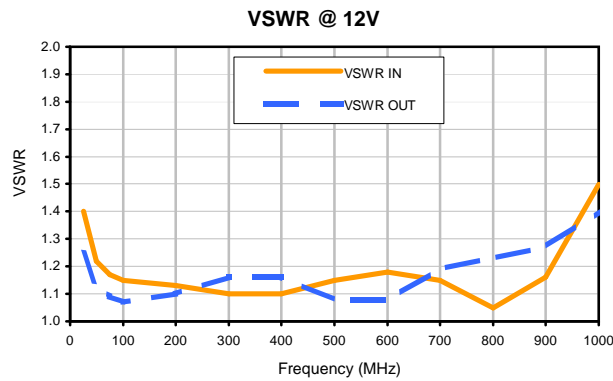
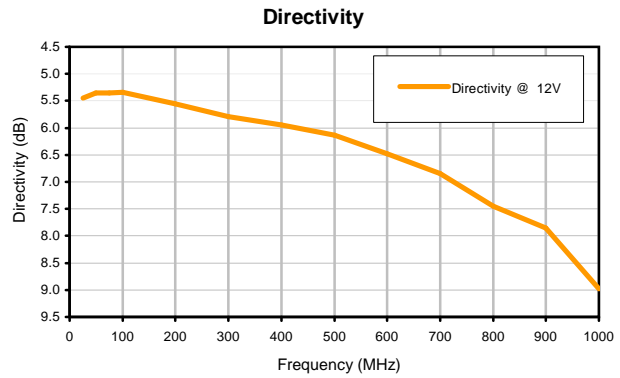
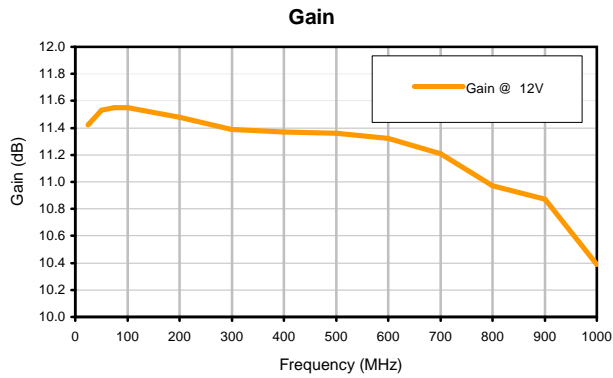

Typical Performance Curves

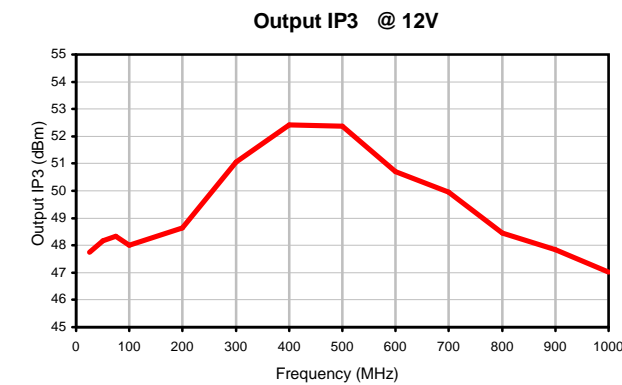
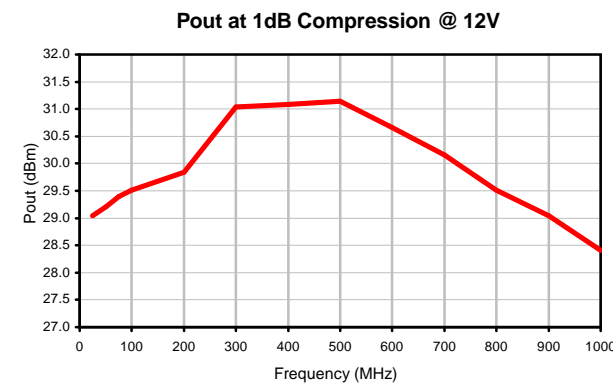
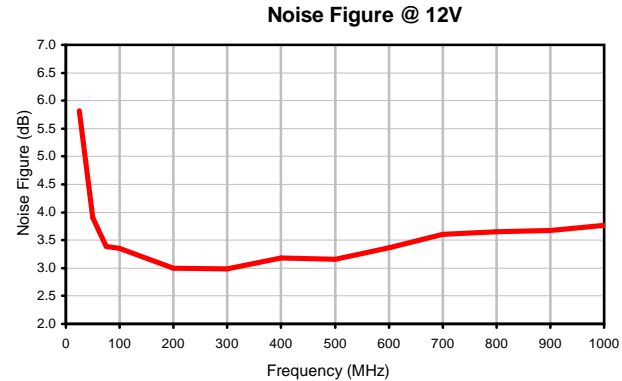
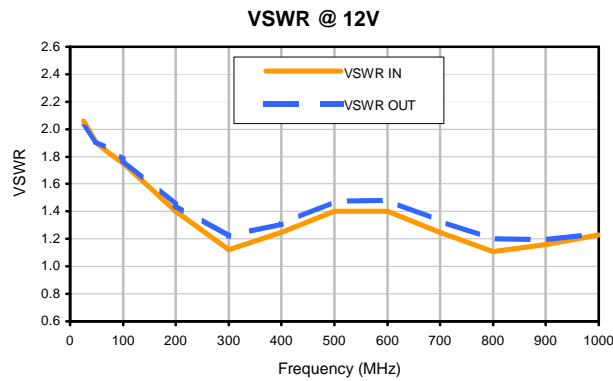
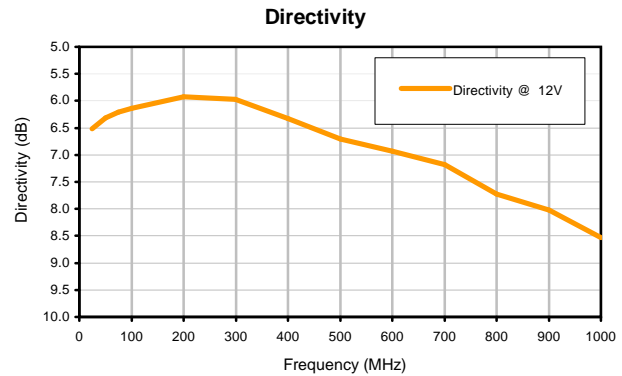
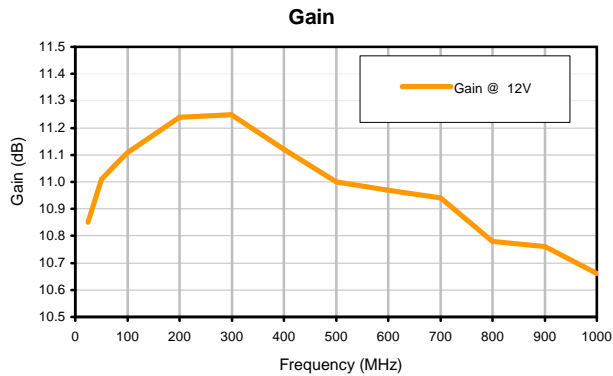

Typical Performance Curves

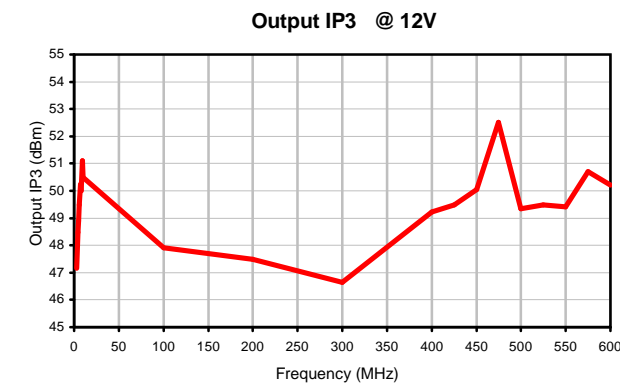
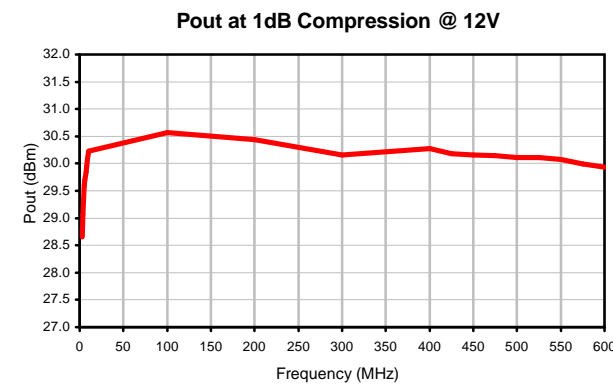
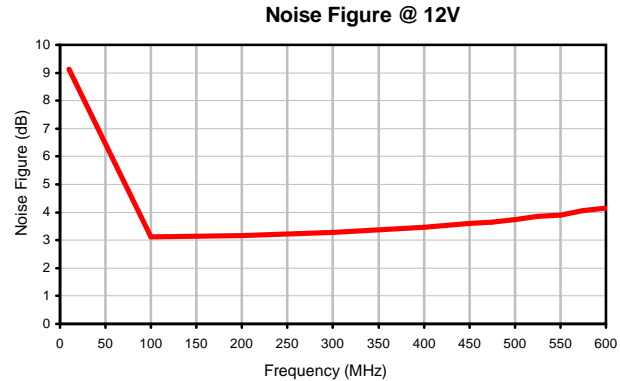
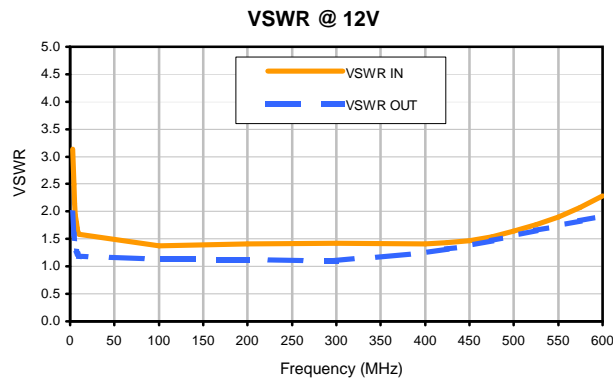
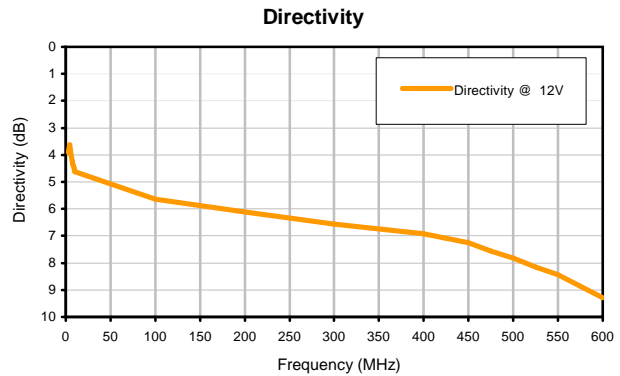
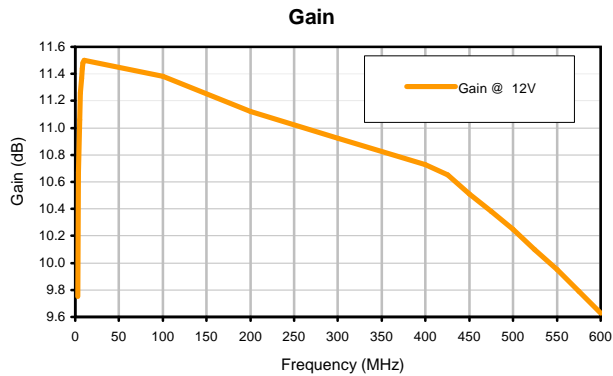

Typical Performance Curves

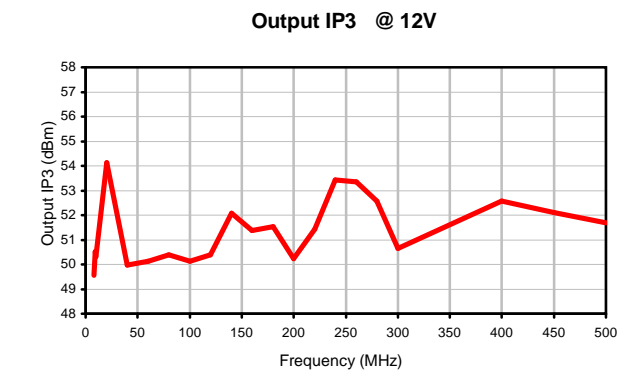
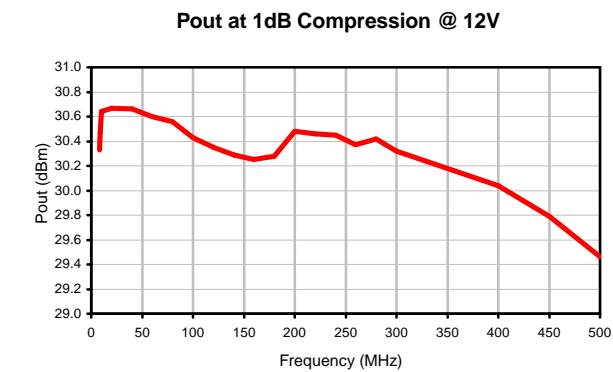
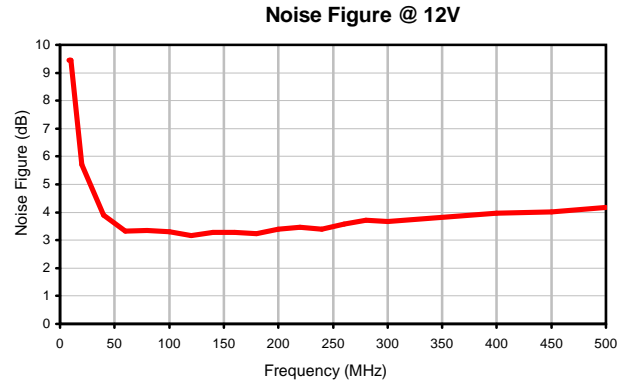
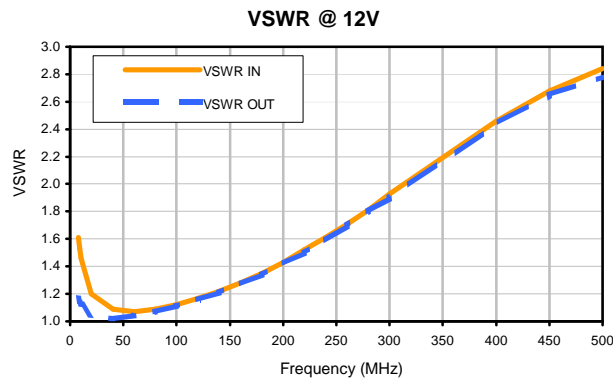
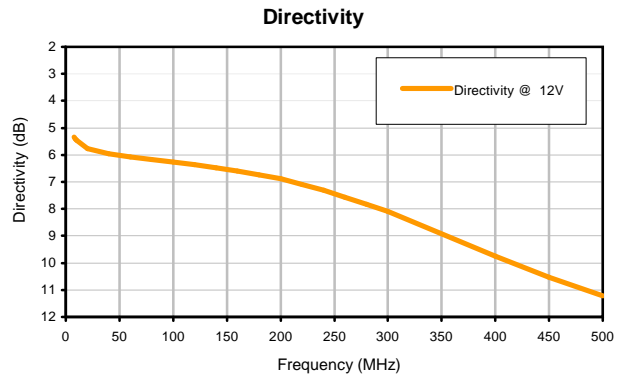
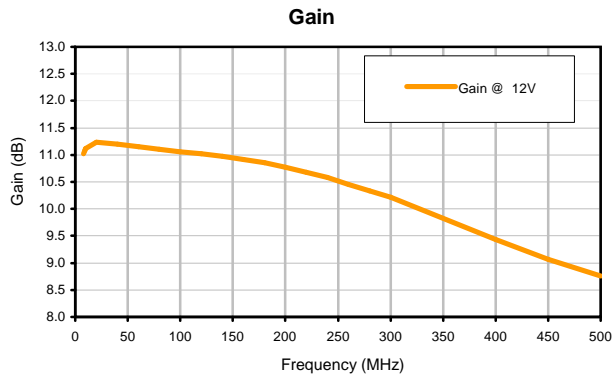

Outline Dimensions

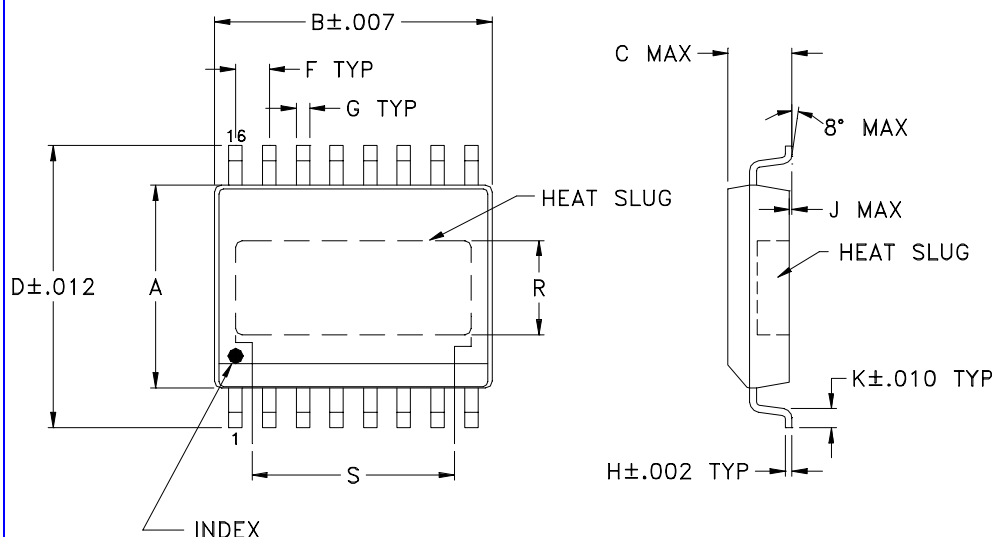

PCB Land Pattern

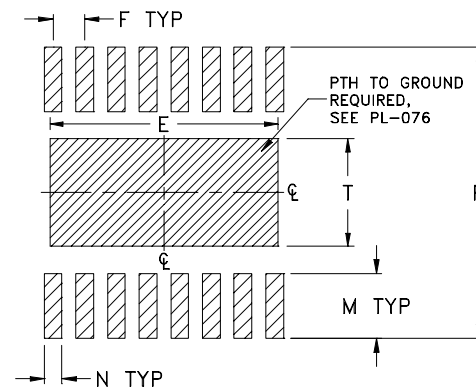

Suggested Layout,
Tolerance to be within $\pm .002$

CASE #	A	B	C	D	E	F	G	H	J	K
CM624	.295 (7.49)	.405 (10.29)	.098 (2.49)	.406 (10.31)	.360 (9.14)	.050 (1.27)	.016 (0.41)	.008 (0.20)	.004 (0.10)	.032 (0.81)

CASE #	L	M	N	P	R	S	T	WT. GRAM
CM624	--	.102 (2.59)	.028 (0.71)	.460 (11.68)	.13 (3.30)	.34 (8.64)	.170 (4.32)	0.67

Dimensions are in inches (mm). Tolerances: 2Pl. $\pm .01$; 3Pl. $\pm .005$

Notes:

- Case material: Plastic.
- Termination finish:
For RoHS Case Styles: Matte Tin plate. All models, (+) suffix.
For RoHS-5 Case Styles: Tin-Lead plate. All models, no (+) suffix.

Tape & Reel Packaging TR-F34

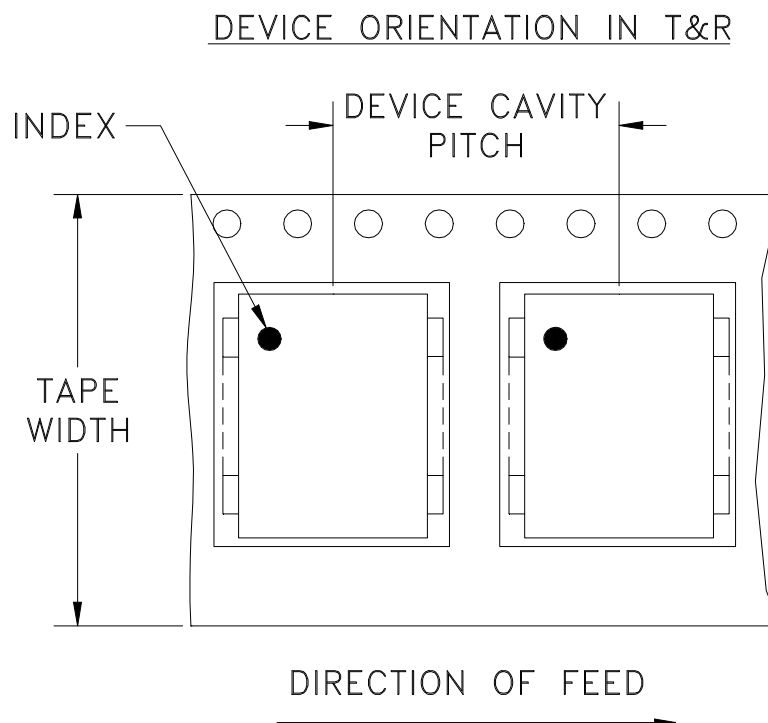

Tape Width, mm	Device Cavity Pitch, mm	Reel Size, inches	Devices per Reel see note	
16	12	7	Small quantity standard (see note)	20
				50
			100	
			200	
		13	Standard	500
				1000

Note: Availability of small reel quantity varies by model.
Refer to pricing and availability on individual model dashboard.

Mini-Circuits carrier tape materials provide protection from ESD (Electro-Static Discharge) during handling and transportation. Tapes are static dissipative and comply with industry standards EIA-481/EIA-541.

Go to: www.minicircuits.com/pages/pdfs/tape.pdf



INTERNET <http://www.minicircuits.com>

P.O. Box 350166, Brooklyn, New York 11235-0003 (718) 934-4500 Fax (718) 332-4661

Distribution Centers NORTH AMERICA 800-654-7949 • 417-335-5935 • Fax 417-335-5945 • EUROPE 44-1252-832600 • Fax 44-1252-837010

Mini-Circuits ISO 9001 & ISO 14001 Certified

THIRD ANGLE PROJECTION

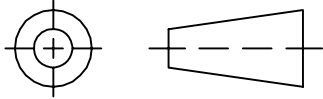

REVISIONS

REV	ECN No.	DESCRIPTION	DATE	DR	AUTH
OR	M82272	NEW RELEASE	08/05/02	GF	DJ
A	M91226	MODIFIED DRAWING	02/27/04	AV	DJ
B	M102713	ADDED "...WITH SMOBC"	01/14/06	GF	IL
C	M109323	UPDATED DESCRIPTION	01/16/07	MMG	LC

SUGGESTED MOUNTING CONFIGURATION FOR
CM624 CASE STYLE, "k1" PIN CONNECTION

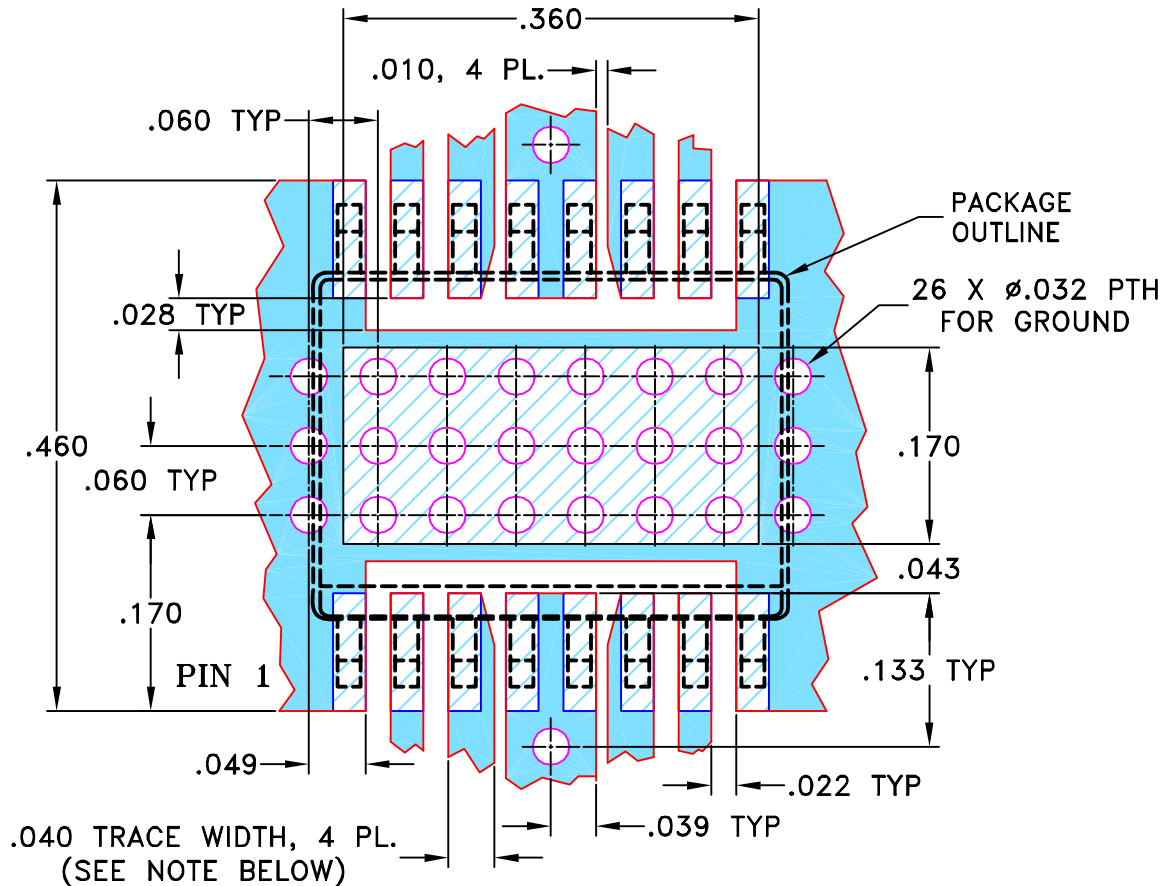

- NOTES: 1. TRACE WIDTH IS SHOWN FOR FR4 WITH DIELECTRIC THICKNESS 0.057" ± .002"; COPPER: 1/2 OZ. EACH SIDE. FOR OTHER MATERIALS TRACE WIDTH MAY NEED TO BE MODIFIED.
2. BOTTOM SIDE OF THE PCB IS CONTINUOUS GROUND PLANE.

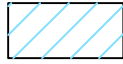
-  DENOTES PCB COPPER LAYOUT WITH SMOBC (SOLDER MASK OVER BARE COPPER)
 DENOTES COPPER LAND PATTERN FREE OF SOLDER MASK

UNLESS OTHERWISE SPECIFIED	INITIALS		DATE
DIMENSIONS ARE IN INCHES TOLERANCES ON: 2 PL DECIMALS ± 3 PL DECIMALS ± .005 ANGLES ± FRACTIONS ±	DRAWN	GF	07/18/02
	CHECKED	LC	08/01/02
	APPROVED	DJ	08/05/02

 **Mini-Circuits®** 13 Neptune Avenue
Brooklyn NY 11235

PL, k1, CM624, HELA-10

SIZE A	CODE IDENT 15542	DRAWING NO: 98-PL-076	REV: C
FILE: 98PL076	SCALE: 6:1	SHEET: 1 OF 1	

Evaluation Board and Circuit

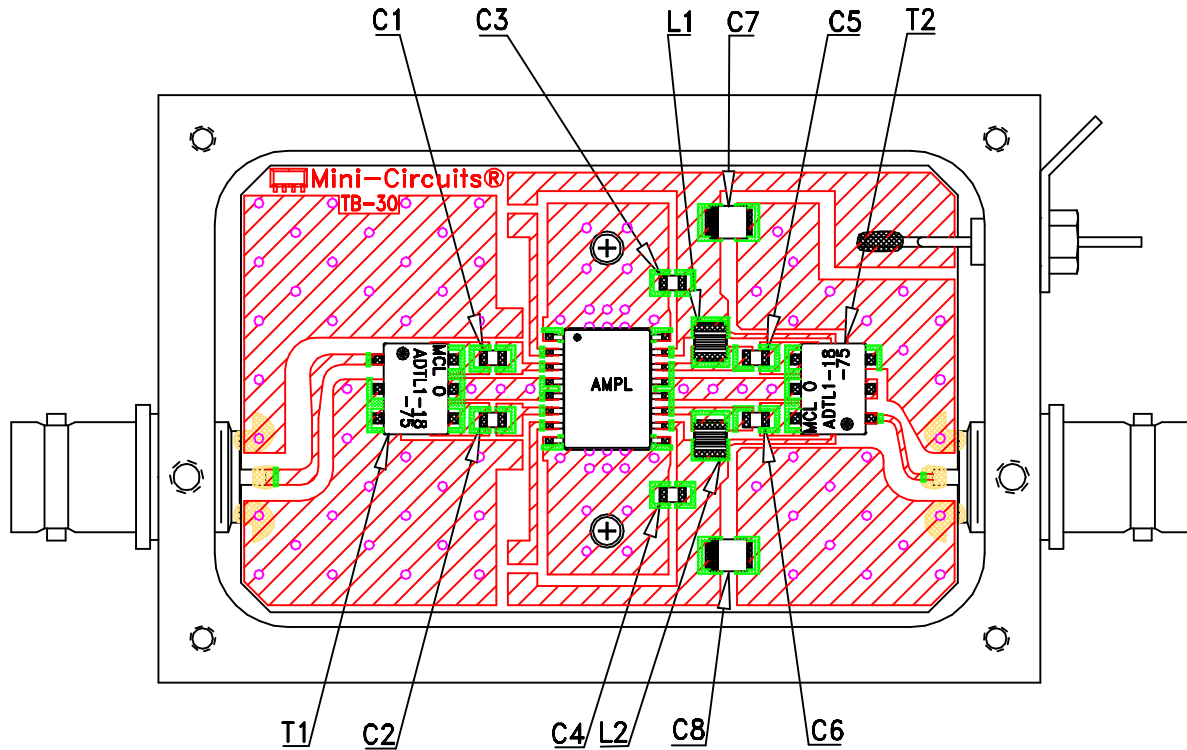

TB-16

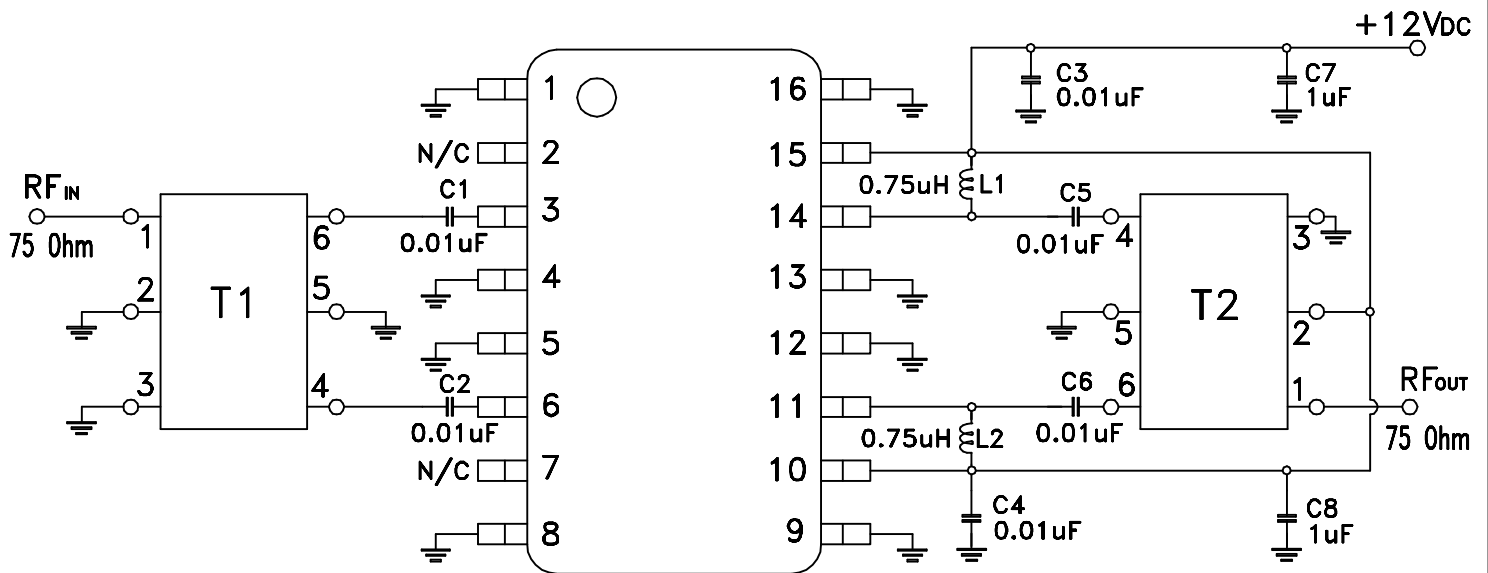

Schematic Diagram

Notes:

1. 75 Ohm BNC Female connectors.
2. PCB Material: Rogers RO4350 or equivalent, Dielectric Constant=3.5, Thickness=.060 inch.

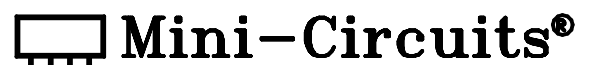

All Mini-Circuits products are manufactured under exacting quality assurance and control standards, and are capable of meeting published specifications after being subjected to any or all of the following physical and environmental test.

Specification	Test/Inspection Condition	Reference/Spec
Operating Temperature	-40° to 110°C Heat Slug Temperature	Individual Model Data Sheet
Storage Temperature	40° to 125° C Ambient Environment	Individual Model Data Sheet
HTOL	Heat Slug =200°C, 168 hrs, +12V	JESD22-A108
Temperature Cycling	-65° to 150°C, 100 cycles	JESD22-A104
HAST	125°C, 85% RH, 96 hours	JESD22-A118, Condition A, except 125°C
Solderability	95% min. solder coverage	JESD22-B102
Solder Reflow Profile	Pb-Free Process: 260°C peak	J-STD-020, Table 4-1, 4-2 and 5-2; Figure 5-1
Vibration (High Frequency)	20g peak, 10-2000 Hz, 12 times in each of three perpendicular directions (total 36)	MIL-STD-202, Method 204, Condition D
Mechanical Shock	50g, 11 ms, 1/2-sine, 18 shocks: 3 each direction, each of 3 axes	MIL-STD-202, Method 213, Condition A
Moisture Sensitivity: Level 2	Bake at 125°C for 24 hours. Soak at 85°C/60%RH for 168 hours Reflow 3 cycles at 260°C peak	J-STD-020
Marking Resistance to Solvents	Isopropyl alcohol + mineral spirits at 25°C; terpene defluxer at 25°C; distilled water + proylene glycol monomethyl ether +	MIL-STD-202, Method 215

All Mini-Circuits products are manufactured under exacting quality assurance and control standards, and are capable of meeting published specifications after being subjected to any or all of the following physical and environmental test.

Specification	Test/Inspection Condition	Reference/Spec
	monoethanolamine at 63°C to 70°C	