

Product Features

- Exact footprint substitute for MAR-8SM and MSA-0886^{a,b}

Benefits:

- lower device voltage, 3.7 typ.
- lower power dissipation in the MMIC
- may eliminate need for choke (RFC)

- High gain, 31.5 dB at 0.1GHz, reduces component count
- High power output, +12.5 dBm typ.
- Internally Matched to 50 Ohms
- Low noise
- Improved stability
- Protection against power supply transients

Typical Applications

- Cellular
- PCN instrumentation



Generic photo used for illustration purposes only

MAR-8SM+

CASE STYLE: WW107

+RoHS Compliant

The +Suffix identifies RoHS Compliance. See our web site for RoHS Compliance methodologies and qualifications

General Description

MAR-8ASM+ (RoHS compliant) is a wideband amplifier offering high dynamic range. It has repeatable performance from lot to lot. It is enclosed in a Micro-X package. MAR-8ASM+ uses Darlington configuration and is fabricated using InGaP HBT technology.

simplified schematic and pin description

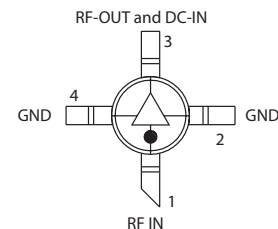
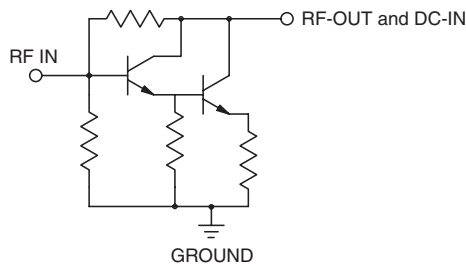

| Function | Pin Number | Description |
|------------------|------------|--|
| RF IN | 1 | RF input pin. This pin requires the use of an external DC blocking capacitor chosen for the frequency of operation. |
| RF-OUT and DC-IN | 3 | RF output and bias pin. DC voltage is present on this pin; therefore a DC blocking capacitor is necessary for proper operation. An RF choke is needed to feed DC bias without loss of RF signal due to the bias connection, as shown in "Recommended Application Circuit". |
| GND | 2,4 | Connections to ground. Use via holes as shown in "Suggested Layout for PCB Design" to reduce ground path inductance for best performance. |

Notes:

- Suitability for model replacement within a particular system must be determined by and is solely the responsibility of the customer based on, among other things, electrical performance criteria, stimulus conditions, application, compatibility with other components and environmental conditions and stresses.
- The Avago MSA-0885 part number is used for identification and comparison purposes only.

Notes

- Performance and quality attributes and conditions not expressly stated in this specification document are intended to be excluded and do not form a part of this specification document.
- Electrical specifications and performance data contained in this specification document are based on Mini-Circuit's applicable established test performance criteria and measurement instructions.
- The parts covered by this specification document are subject to Mini-Circuits standard limited warranty and terms and conditions (collectively, "Standard Terms"); Purchasers of this part are entitled to the rights and benefits contained therein. For a full statement of the Standard Terms and the exclusive rights and remedies thereunder, please visit Mini-Circuits' website at www.minicircuits.com/MCLStore/terms.jsp



Electrical Specifications at 25°C and 36mA, unless noted

| Parameter | Min. | Typ. | Max. | Units | |
|---|----------------------|----------------------|------------|--------|-------|
| Frequency Range* | DC | | 1 | GHz | |
| Gain | f=0.1 GHz f=1 GHz | — 20 ² | 31.5 25 | — — | dB |
| Input Return Loss | f=DC to 1 GHz | | 15.5 | | dB |
| Output Return Loss | f=DC to 1 GHz | | 11 | | dB |
| Output Power @ 1 dB compression | f=1 GHz | | +12.5 | | dBm |
| Output IP3 | f=1 GHz | | +25 | | dBm |
| Noise Figure | f=1 GHz | | 3.1 | | dB |
| Recommended Device Operating Current | | | 36 | | mA |
| Device Operating Voltage | | | 3.7 | | V |
| Device Voltage Variation vs. Temperature at 36 mA | | | +1.2 | | mV/°C |
| Device Voltage Variation vs. Current at 25°C | | | 11.3 | | mV/mA |
| Thermal Resistance, junction-to-case ¹ | | | 140 | | °C/W |

*Guaranteed specification DC-1 GHz. Low frequency cut off determined by external coupling capacitors.

Absolute Maximum Ratings

| Parameter | Ratings |
|-----------------------|----------------|
| Operating Temperature | -40°C to 85°C |
| Storage Temperature | -55°C to 100°C |
| Operating Current | 65mA |
| Power Dissipation | 250mW |
| Input Power | 13dBm |

Note: Permanent damage may occur if any of these limits are exceeded.

These ratings are not intended for continuous normal operation.

¹Case is defined as ground leads.

²Full temperature range.

Notes

- A. Performance and quality attributes and conditions not expressly stated in this specification document are intended to be excluded and do not form a part of this specification document.
 B. Electrical specifications and performance data contained in this specification document are based on Mini-Circuit's applicable established test performance criteria and measurement instructions.
 C. The parts covered by this specification document are subject to Mini-Circuits standard limited warranty and terms and conditions (collectively, "Standard Terms"); Purchasers of this part are entitled to the rights and benefits contained therein. For a full statement of the Standard Terms and the exclusive rights and remedies thereunder, please visit Mini-Circuits' website at www.minicircuits.com/MCLStore/terms.jsp



Product Marking

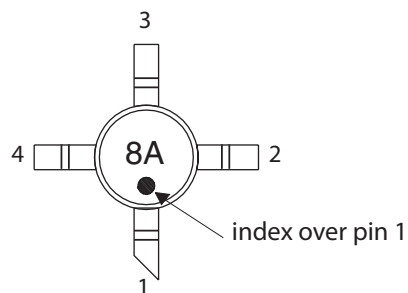

Markings in addition to model number designation may appear for internal quality control purposes.

Additional Detailed Technical Information

Additional information is available on our web site. To access this information enter the model number on our web site home page.

Performance data, graphs, s-parameter data set (.zip file)

Case Style: WW107

Plastic micro-x, .085 body diameter, lead finish: matte-tin

Tape & Reel: F4

7" Reels with 20, 50, 100, 200, 500, 1K devices

13" Reels with 2K, 4K devices

Suggested Layout for PCB Design: PL-253

Evaluation Board: TB-411-8A+

Environmental Ratings: ENV08T3

Recommended Application Circuit

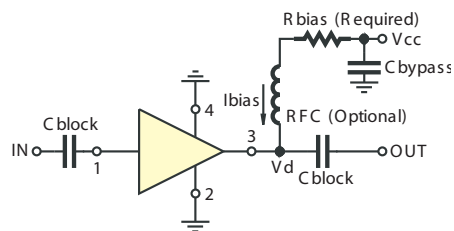

Test Board includes case, connectors, and components (in bold) soldered to PCB

| R BIAS ¹ | |
|---------------------|----------------------------------|
| Vcc | Bias Resistor Value ² |
| 7 | 88.7 |
| 8 | 118 |
| 9 | 143 |
| 10 | 174 |
| 11 | 200 |
| 12 | 226 |
| 13 | 255 |
| 14 | 280 |
| 15 | 309 |

¹ When being used as a substitute for MAR-8SM or MSA-0866, the bias resistor values must be changed to the values in this table.

² 1% Resistor values (ohms) for optimum bias.

Notes

- A. Performance and quality attributes and conditions not expressly stated in this specification document are intended to be excluded and do not form a part of this specification document.
- B. Electrical specifications and performance data contained in this specification document are based on Mini-Circuit's applicable established test performance criteria and measurement instructions.
- C. The parts covered by this specification document are subject to Mini-Circuits standard limited warranty and terms and conditions (collectively, "Standard Terms"); Purchasers of this part are entitled to the rights and benefits contained therein. For a full statement of the Standard Terms and the exclusive rights and remedies thereunder, please visit Mini-Circuits' website at www.minicircuits.com/MCLStore/terms.jsp



ESD Rating

Human Body Model (HBM): Class 2 (2000 v to < 4000 v) in accordance with ANSI/ESD STM 5.1 - 2001

Machine Model (MM): Class M1 (<100 v) in accordance with ANSI/ESD STM 5.2 - 1999

MSL Rating

Moisture Sensitivity: MSL1 in accordance with IPC/JEDECJ-STD-020C

| No. | Test Required | Condition | Standard | Quantity |
|-----|------------------------------|---|-----------------------------|----------|
| 1 | Visual Inspection | Low Power Microscope Magnification 40x | MIP-IN-0003 (MCT spec) | 45 units |
| 2 | Electrical Test | Room Temperature | SCD (MCL spec) | 45 units |
| 3 | SAM Analysis | Less than 10% growth in term of delamination | J-Std-020C (Jedec Standard) | 45 units |
| 4 | Moisture Sensitivity Level 1 | Bake at 125°C for 24 hours Soak at 85°C/85%RH for 168 hours Reflow 3 cycles at 260°C peak | J-Std-020C (Jedec Standard) | 45 units |

MSL Test Flow Chart

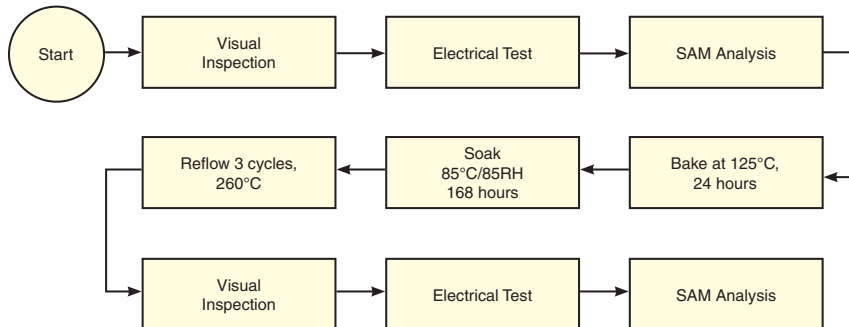

Notes

- A. Performance and quality attributes and conditions not expressly stated in this specification document are intended to be excluded and do not form a part of this specification document.
- B. Electrical specifications and performance data contained in this specification document are based on Mini-Circuit's applicable established test performance criteria and measurement instructions.
- C. The parts covered by this specification document are subject to Mini-Circuits standard limited warranty and terms and conditions (collectively, "Standard Terms"); Purchasers of this part are entitled to the rights and benefits contained therein. For a full statement of the Standard Terms and the exclusive rights and remedies thereunder, please visit Mini-Circuits' website at www.minicircuits.com/MCLStore/terms.jsp



MMIC Amplifier

MAR-8ASM+

Typical Performance Data

**NOTE: Use PDF Bookmarks to view DATA at required conditions
or to view GRAPHS.**

Definitions:

Input Return Loss = -S11 (dB)

Gain(Power Gain) = S21 (dB)

Reverse Isolation = -S12 (dB)

Output Return Loss = -S22 (dB)

TEST CONDITIONS: I_{cc}=36mA; V_{cc}=3.97V@Temp.=+25degC

| FREQ | Gain | Isolation | Input Return Loss | Output Return Loss | Stability | | IP3 Output | 1dB Comp. Output | Noise Figure |
|-------|-------|-----------|-------------------|--------------------|-----------|-------|------------|------------------|--------------|
| | | | | | K | Delta | | | |
| (MHz) | (dB) | (dB) | (dB) | (dB) | K | Delta | (dBm) | (dBm) | (dB) |
| 50 | 31.43 | 34.52 | 15.52 | 12.46 | 1.04 | 0.74 | 26.36 | 12.85 | 2.13 |
| 60 | 31.50 | 34.53 | 15.95 | 12.54 | 1.04 | 0.74 | 26.45 | 12.91 | 2.17 |
| 80 | 31.37 | 34.43 | 15.47 | 12.61 | 1.04 | 0.74 | 26.70 | 12.84 | 2.20 |
| 100 | 31.34 | 34.46 | 15.08 | 12.65 | 1.04 | 0.74 | 26.46 | 12.80 | 2.26 |
| 120 | 31.23 | 34.26 | 16.14 | 12.68 | 1.04 | 0.74 | 26.22 | 12.72 | 2.27 |
| 140 | 31.12 | 34.40 | 15.51 | 12.71 | 1.05 | 0.72 | 25.93 | 12.64 | 2.25 |
| 160 | 30.87 | 34.30 | 16.55 | 12.75 | 1.05 | 0.71 | 25.69 | 12.63 | 2.31 |
| 180 | 30.83 | 34.21 | 15.57 | 12.83 | 1.05 | 0.71 | 25.74 | 12.55 | 2.28 |
| 200 | 30.66 | 34.15 | 16.03 | 12.87 | 1.06 | 0.70 | 25.98 | 12.65 | 2.28 |
| 220 | 30.51 | 34.09 | 16.32 | 12.98 | 1.06 | 0.69 | 26.13 | 12.74 | 2.36 |
| 240 | 30.37 | 33.95 | 16.36 | 13.01 | 1.06 | 0.69 | 25.95 | 12.72 | 2.36 |
| 260 | 30.17 | 33.96 | 16.06 | 13.10 | 1.07 | 0.67 | 26.00 | 12.64 | 2.41 |
| 280 | 29.96 | 33.80 | 15.82 | 13.16 | 1.07 | 0.67 | 26.02 | 12.56 | 2.46 |
| 300 | 29.82 | 33.75 | 16.13 | 13.19 | 1.07 | 0.66 | 25.79 | 12.38 | 2.55 |
| 320 | 29.63 | 33.62 | 15.92 | 13.26 | 1.08 | 0.66 | 25.69 | 12.49 | 2.51 |
| 340 | 29.44 | 33.52 | 16.23 | 13.33 | 1.08 | 0.65 | 25.67 | 12.60 | 2.54 |
| 360 | 29.25 | 33.39 | 16.19 | 13.40 | 1.08 | 0.64 | 25.60 | 12.59 | 2.61 |
| 380 | 29.07 | 33.24 | 16.23 | 13.45 | 1.08 | 0.64 | 25.60 | 12.60 | 2.62 |
| 400 | 28.89 | 33.16 | 16.64 | 13.55 | 1.09 | 0.63 | 25.53 | 12.55 | 2.63 |
| 420 | 28.71 | 32.95 | 16.47 | 13.60 | 1.08 | 0.63 | 25.43 | 12.54 | 2.64 |
| 440 | 28.47 | 32.82 | 16.47 | 13.67 | 1.09 | 0.62 | 25.39 | 12.63 | 2.63 |
| 460 | 28.32 | 32.70 | 16.56 | 13.76 | 1.09 | 0.62 | 25.59 | 12.62 | 2.71 |
| 480 | 28.15 | 32.54 | 16.43 | 13.82 | 1.09 | 0.62 | 25.55 | 12.58 | 2.71 |
| 500 | 27.96 | 32.40 | 16.78 | 13.91 | 1.09 | 0.61 | 25.68 | 12.63 | 2.76 |
| 520 | 27.78 | 32.24 | 16.20 | 13.90 | 1.09 | 0.61 | 25.79 | 12.67 | 2.73 |
| 540 | 27.58 | 32.01 | 16.37 | 13.96 | 1.09 | 0.61 | 25.85 | 12.69 | 2.76 |
| 560 | 27.43 | 31.89 | 16.42 | 14.04 | 1.09 | 0.60 | 25.81 | 12.68 | 2.82 |
| 580 | 27.24 | 31.74 | 16.74 | 14.04 | 1.09 | 0.60 | 25.82 | 12.68 | 2.79 |
| 600 | 27.10 | 31.56 | 16.50 | 14.11 | 1.09 | 0.60 | 25.94 | 12.72 | 2.81 |
| 620 | 26.88 | 31.40 | 16.32 | 14.12 | 1.09 | 0.59 | 25.97 | 12.74 | 2.81 |
| 640 | 26.72 | 31.25 | 16.61 | 14.19 | 1.09 | 0.59 | 25.91 | 12.71 | 2.78 |
| 660 | 26.58 | 31.07 | 16.70 | 14.16 | 1.09 | 0.59 | 26.06 | 12.68 | 2.85 |
| 680 | 26.39 | 30.85 | 16.78 | 14.22 | 1.08 | 0.60 | 26.13 | 12.75 | 2.84 |
| 700 | 26.20 | 30.73 | 16.42 | 14.22 | 1.08 | 0.59 | 26.19 | 12.77 | 2.83 |
| 750 | 25.82 | 30.29 | 16.63 | 14.37 | 1.08 | 0.59 | 26.04 | 12.82 | 2.81 |
| 800 | 25.42 | 29.88 | 16.83 | 14.31 | 1.08 | 0.59 | 25.90 | 12.76 | 2.88 |
| 850 | 25.04 | 29.50 | 16.78 | 14.30 | 1.07 | 0.59 | 25.76 | 12.82 | 2.86 |
| 900 | 24.65 | 29.08 | 16.80 | 14.32 | 1.07 | 0.58 | 25.35 | 12.73 | 2.84 |
| 940 | 24.29 | 28.71 | 17.07 | 14.27 | 1.07 | 0.58 | 25.52 | 12.81 | 2.92 |
| 1000 | 23.95 | 28.33 | 16.83 | 14.17 | 1.06 | 0.58 | 25.65 | 12.78 | 2.87 |

REV. X1
MAR-8ASM+
070829
Page 1 of 11



IF/RF MICROWAVE COMPONENTS • ISO 9001 ISO 14001 AS 9100 CERTIFIED • RoHS compliant
P.O. Box 350166, Brooklyn, New York 11235-0003 (718) 934-4500 Fax (718) 332-4661



The Design Engineers Search Engine finds the model you need, Instantly • For detailed performance specs & shopping online see



MMIC Amplifier

MAR-8ASM+

Typical Performance Data

Definitions:

Input Return Loss = -S11 (dB)

Gain(Power Gain) = S21 (dB)

Reverse Isolation = -S12 (dB)

Output Return Loss = -S22 (dB)

TEST CONDITIONS: Icc=29mA; Vcc=3.87V@Temp.=+25degC

| FREQ | Gain | Isolation | Input Return Loss | Output Return Loss | Stability | | IP3 Output | 1dB Comp. Output | Noise Figure |
|-------|-------|-----------|-------------------|--------------------|-----------|-------|------------|------------------|--------------|
| | | | | | K | Delta | | | |
| (MHz) | (dB) | (dB) | (dB) | (dB) | K | Delta | (dBm) | (dBm) | (dB) |
| 50 | 30.34 | 33.78 | 12.12 | 9.83 | 1.04 | 0.75 | 24.75 | 11.10 | 2.14 |
| 60 | 30.47 | 33.87 | 12.82 | 9.88 | 1.04 | 0.75 | 24.92 | 11.17 | 2.15 |
| 80 | 30.33 | 33.96 | 12.37 | 9.95 | 1.05 | 0.73 | 25.19 | 11.10 | 2.17 |
| 100 | 30.33 | 33.84 | 12.33 | 10.01 | 1.04 | 0.74 | 24.87 | 11.03 | 2.24 |
| 120 | 30.24 | 33.71 | 12.87 | 10.07 | 1.04 | 0.74 | 24.64 | 10.77 | 2.23 |
| 140 | 30.14 | 33.72 | 12.89 | 10.12 | 1.04 | 0.73 | 24.35 | 10.63 | 2.22 |
| 160 | 29.95 | 33.68 | 13.71 | 10.14 | 1.05 | 0.71 | 24.09 | 10.57 | 2.28 |
| 180 | 29.90 | 33.60 | 12.95 | 10.19 | 1.04 | 0.72 | 24.05 | 10.48 | 2.24 |
| 200 | 29.74 | 33.52 | 13.13 | 10.29 | 1.05 | 0.71 | 24.27 | 10.66 | 2.27 |
| 220 | 29.62 | 33.53 | 13.50 | 10.35 | 1.05 | 0.69 | 24.43 | 10.82 | 2.31 |
| 240 | 29.48 | 33.44 | 13.51 | 10.38 | 1.05 | 0.69 | 24.21 | 10.85 | 2.33 |
| 260 | 29.32 | 33.29 | 13.35 | 10.49 | 1.05 | 0.68 | 24.27 | 10.62 | 2.38 |
| 280 | 29.15 | 33.24 | 13.37 | 10.56 | 1.05 | 0.67 | 24.22 | 10.41 | 2.47 |
| 300 | 29.05 | 33.13 | 13.71 | 10.59 | 1.05 | 0.67 | 23.87 | 10.22 | 2.51 |
| 320 | 28.87 | 33.03 | 13.75 | 10.69 | 1.06 | 0.66 | 23.82 | 10.49 | 2.50 |
| 340 | 28.71 | 32.96 | 13.97 | 10.78 | 1.06 | 0.65 | 23.70 | 10.55 | 2.53 |
| 360 | 28.55 | 32.82 | 13.89 | 10.88 | 1.06 | 0.65 | 23.63 | 10.58 | 2.57 |
| 380 | 28.38 | 32.69 | 13.94 | 10.95 | 1.06 | 0.64 | 23.63 | 10.65 | 2.58 |
| 400 | 28.21 | 32.58 | 14.26 | 11.06 | 1.06 | 0.63 | 23.59 | 10.57 | 2.59 |
| 420 | 28.06 | 32.41 | 14.27 | 11.13 | 1.06 | 0.63 | 23.45 | 10.44 | 2.62 |
| 440 | 27.86 | 32.27 | 14.35 | 11.21 | 1.06 | 0.63 | 23.41 | 10.52 | 2.60 |
| 460 | 27.73 | 32.17 | 14.47 | 11.33 | 1.06 | 0.62 | 23.62 | 10.52 | 2.69 |
| 480 | 27.58 | 32.02 | 14.47 | 11.39 | 1.06 | 0.62 | 23.62 | 10.47 | 2.69 |
| 500 | 27.41 | 31.90 | 14.75 | 11.49 | 1.07 | 0.61 | 23.75 | 10.58 | 2.72 |
| 520 | 27.25 | 31.75 | 14.34 | 11.54 | 1.06 | 0.61 | 23.90 | 10.62 | 2.73 |
| 540 | 27.06 | 31.56 | 14.55 | 11.65 | 1.06 | 0.61 | 24.01 | 10.77 | 2.71 |
| 560 | 26.94 | 31.41 | 14.72 | 11.78 | 1.06 | 0.61 | 23.96 | 10.57 | 2.73 |
| 580 | 26.77 | 31.25 | 14.95 | 11.82 | 1.06 | 0.60 | 23.99 | 10.65 | 2.77 |
| 600 | 26.65 | 31.11 | 14.78 | 11.89 | 1.06 | 0.60 | 24.18 | 10.81 | 2.79 |
| 620 | 26.44 | 30.93 | 14.73 | 11.96 | 1.06 | 0.60 | 24.24 | 10.73 | 2.79 |
| 640 | 26.31 | 30.81 | 14.93 | 12.08 | 1.06 | 0.60 | 24.15 | 10.70 | 2.77 |
| 660 | 26.16 | 30.63 | 15.12 | 12.10 | 1.06 | 0.60 | 24.26 | 10.70 | 2.78 |
| 680 | 26.00 | 30.43 | 15.17 | 12.21 | 1.06 | 0.60 | 24.41 | 10.67 | 2.81 |
| 700 | 25.85 | 30.31 | 15.00 | 12.26 | 1.06 | 0.60 | 24.63 | 10.79 | 2.80 |
| 750 | 25.48 | 29.92 | 15.21 | 12.41 | 1.05 | 0.59 | 24.71 | 11.05 | 2.80 |
| 800 | 25.12 | 29.50 | 15.39 | 12.50 | 1.05 | 0.59 | 24.50 | 10.77 | 2.81 |
| 850 | 24.75 | 29.14 | 15.48 | 12.65 | 1.05 | 0.59 | 24.62 | 11.05 | 2.86 |
| 900 | 24.38 | 28.74 | 15.55 | 12.74 | 1.04 | 0.59 | 24.41 | 11.24 | 2.84 |
| 940 | 24.07 | 28.37 | 15.78 | 12.77 | 1.04 | 0.59 | 24.41 | 11.07 | 2.89 |
| 1000 | 23.73 | 28.03 | 15.70 | 12.88 | 1.04 | 0.59 | 24.81 | 11.17 | 2.84 |

REV. X1
MAR-8ASM+
070829
Page 2 of 11



IF/RF MICROWAVE COMPONENTS • ISO 9001 ISO 14001 AS 9100 CERTIFIED • RoHS compliant
P.O. Box 350166, Brooklyn, New York 11235-0003 (718) 934-4500 Fax (718) 332-4661



The Design Engineers Search Engine finds the model you need, Instantly • For detailed performance specs & shopping online see



MMIC Amplifier

MAR-8ASM+

Typical Performance Data

Definitions:

Input Return Loss = -S11 (dB)

Gain(Power Gain) = S21 (dB)

Reverse Isolation = -S12 (dB)

Output Return Loss = -S22 (dB)

TEST CONDITIONS: Icc=43mA; Vcc=4.05V@Temp.=+25degC

| FREQ | Gain | Isolation | Input Return Loss | Output Return Loss | Stability | | IP3 Output | 1dB Comp. Output | Noise Figure |
|-------|-------|-----------|-------------------|--------------------|-----------|-------|------------|------------------|--------------|
| | | | | | K | Delta | | | |
| (MHz) | (dB) | (dB) | (dB) | (dB) | K | Delta | (dBm) | (dBm) | (dB) |
| 50 | 32.14 | 34.94 | 18.00 | 14.96 | 1.04 | 0.75 | 27.84 | 13.78 | 2.16 |
| 60 | 32.18 | 34.77 | 19.49 | 15.04 | 1.03 | 0.76 | 27.96 | 13.75 | 2.17 |
| 80 | 32.03 | 34.91 | 18.34 | 15.08 | 1.04 | 0.74 | 28.19 | 13.69 | 2.22 |
| 100 | 32.01 | 34.73 | 17.44 | 15.24 | 1.04 | 0.75 | 27.92 | 13.68 | 2.29 |
| 120 | 31.86 | 34.85 | 18.61 | 15.27 | 1.05 | 0.73 | 27.70 | 13.70 | 2.32 |
| 140 | 31.74 | 34.87 | 18.22 | 15.27 | 1.05 | 0.72 | 27.44 | 13.82 | 2.29 |
| 160 | 31.47 | 34.69 | 19.59 | 15.25 | 1.06 | 0.71 | 27.24 | 13.86 | 2.31 |
| 180 | 31.44 | 34.62 | 17.74 | 15.35 | 1.06 | 0.71 | 27.31 | 13.74 | 2.29 |
| 200 | 31.25 | 34.56 | 17.98 | 15.39 | 1.06 | 0.70 | 27.55 | 13.62 | 2.29 |
| 220 | 31.06 | 34.44 | 19.01 | 15.51 | 1.06 | 0.69 | 27.65 | 13.62 | 2.38 |
| 240 | 30.90 | 34.36 | 18.33 | 15.49 | 1.07 | 0.69 | 27.49 | 13.59 | 2.39 |
| 260 | 30.70 | 34.27 | 18.22 | 15.57 | 1.07 | 0.68 | 27.51 | 13.69 | 2.43 |
| 280 | 30.48 | 34.17 | 17.86 | 15.58 | 1.07 | 0.67 | 27.64 | 13.84 | 2.49 |
| 300 | 30.32 | 34.14 | 18.05 | 15.53 | 1.08 | 0.66 | 27.48 | 13.86 | 2.58 |
| 320 | 30.11 | 33.97 | 17.86 | 15.57 | 1.08 | 0.66 | 27.39 | 13.76 | 2.55 |
| 340 | 29.91 | 33.87 | 18.09 | 15.65 | 1.09 | 0.65 | 27.33 | 13.66 | 2.55 |
| 360 | 29.71 | 33.74 | 18.06 | 15.69 | 1.09 | 0.64 | 27.23 | 13.54 | 2.64 |
| 380 | 29.51 | 33.59 | 17.76 | 15.67 | 1.09 | 0.64 | 27.18 | 13.56 | 2.64 |
| 400 | 29.29 | 33.46 | 18.08 | 15.75 | 1.09 | 0.63 | 27.07 | 13.66 | 2.65 |
| 420 | 29.10 | 33.30 | 17.92 | 15.73 | 1.09 | 0.63 | 26.96 | 13.70 | 2.67 |
| 440 | 28.87 | 33.13 | 17.86 | 15.72 | 1.10 | 0.62 | 26.93 | 13.68 | 2.67 |
| 460 | 28.69 | 32.99 | 17.90 | 15.77 | 1.10 | 0.62 | 27.08 | 13.65 | 2.72 |
| 480 | 28.51 | 32.82 | 17.70 | 15.82 | 1.10 | 0.62 | 27.01 | 13.60 | 2.75 |
| 500 | 28.30 | 32.68 | 18.03 | 15.84 | 1.10 | 0.61 | 27.08 | 13.58 | 2.77 |
| 520 | 28.12 | 32.52 | 17.34 | 15.81 | 1.10 | 0.61 | 27.11 | 13.55 | 2.78 |
| 540 | 27.88 | 32.32 | 17.70 | 15.74 | 1.10 | 0.60 | 27.11 | 13.51 | 2.79 |
| 560 | 27.72 | 32.18 | 17.61 | 15.79 | 1.10 | 0.60 | 27.04 | 13.52 | 2.86 |
| 580 | 27.54 | 32.00 | 17.90 | 15.70 | 1.10 | 0.60 | 27.02 | 13.51 | 2.83 |
| 600 | 27.38 | 31.82 | 17.51 | 15.74 | 1.10 | 0.60 | 27.10 | 13.52 | 2.83 |
| 620 | 27.15 | 31.65 | 17.39 | 15.70 | 1.10 | 0.60 | 27.05 | 13.55 | 2.85 |
| 640 | 27.00 | 31.48 | 17.50 | 15.72 | 1.10 | 0.60 | 27.01 | 13.57 | 2.82 |
| 660 | 26.84 | 31.30 | 17.69 | 15.64 | 1.10 | 0.60 | 27.16 | 13.57 | 2.88 |
| 680 | 26.62 | 31.12 | 17.78 | 15.67 | 1.10 | 0.59 | 27.15 | 13.56 | 2.86 |
| 700 | 26.45 | 30.96 | 17.57 | 15.59 | 1.10 | 0.59 | 27.06 | 13.51 | 2.83 |
| 750 | 26.04 | 30.51 | 17.52 | 15.63 | 1.09 | 0.59 | 26.79 | 13.32 | 2.86 |
| 800 | 25.62 | 30.08 | 17.81 | 15.47 | 1.09 | 0.59 | 26.68 | 13.54 | 2.89 |
| 850 | 25.24 | 29.67 | 17.80 | 15.39 | 1.08 | 0.59 | 26.34 | 13.35 | 2.92 |
| 900 | 24.83 | 29.27 | 17.72 | 15.25 | 1.08 | 0.59 | 25.85 | 13.12 | 2.87 |
| 940 | 24.45 | 28.87 | 18.10 | 15.10 | 1.08 | 0.59 | 26.13 | 13.41 | 2.94 |
| 1000 | 24.11 | 28.47 | 17.76 | 14.98 | 1.07 | 0.59 | 26.05 | 13.26 | 2.93 |

REV. X1
MAR-8ASM+
070829
Page 3 of 11



IF/RF MICROWAVE COMPONENTS • ISO 9001 ISO 14001 AS 9100 CERTIFIED • RoHS compliant
P.O. Box 350166, Brooklyn, New York 11235-0003 (718) 934-4500 Fax (718) 332-4661



The Design Engineers Search Engine finds the model you need, Instantly • For detailed performance specs & shopping online see



MMIC Amplifier

MAR-8ASM+

Typical Performance Data

Definitions:

Input Return Loss = -S11 (dB)

Gain(Power Gain) = S21 (dB)

Reverse Isolation = -S12 (dB)

Output Return Loss = -S22 (dB)

TEST CONDITIONS: Icc=36mA; Vcc=3.95V@Temp.= -45degC

| FREQ | Gain | Isolation | Input Return Loss | Output Return Loss | Stability | | IP3 Output | 1dB Comp. Output | Noise Figure |
|-------|-------|-----------|-------------------|--------------------|-----------|-------|------------|------------------|--------------|
| | | | | | K | Delta | | | |
| (MHz) | (dB) | (dB) | (dB) | (dB) | K | Delta | (dBm) | (dBm) | (dB) |
| 50 | 31.88 | 34.86 | 17.33 | 14.04 | 1.05 | 0.74 | 25.74 | 13.09 | 1.76 |
| 60 | 31.94 | 34.75 | 17.40 | 14.13 | 1.04 | 0.75 | 25.72 | 13.14 | 1.79 |
| 80 | 31.79 | 34.60 | 17.53 | 14.05 | 1.04 | 0.75 | 25.82 | 13.05 | 1.81 |
| 100 | 31.77 | 34.66 | 16.77 | 14.21 | 1.04 | 0.74 | 25.61 | 13.01 | 1.90 |
| 120 | 31.64 | 34.72 | 17.67 | 14.25 | 1.05 | 0.73 | 25.50 | 12.89 | 1.88 |
| 140 | 31.55 | 34.55 | 17.61 | 14.32 | 1.05 | 0.73 | 25.31 | 12.84 | 1.86 |
| 160 | 31.30 | 34.53 | 19.02 | 14.34 | 1.05 | 0.71 | 25.21 | 12.82 | 1.91 |
| 180 | 31.26 | 34.33 | 17.58 | 14.43 | 1.05 | 0.72 | 25.33 | 12.75 | 1.89 |
| 200 | 31.08 | 34.32 | 17.35 | 14.48 | 1.05 | 0.71 | 25.62 | 12.91 | 1.97 |
| 220 | 30.91 | 34.27 | 18.50 | 14.58 | 1.06 | 0.70 | 25.85 | 12.97 | 1.94 |
| 240 | 30.77 | 34.13 | 18.11 | 14.55 | 1.06 | 0.70 | 25.72 | 12.87 | 1.95 |
| 260 | 30.58 | 34.07 | 17.64 | 14.65 | 1.06 | 0.69 | 25.74 | 12.90 | 2.01 |
| 280 | 30.38 | 34.01 | 17.58 | 14.69 | 1.07 | 0.68 | 25.75 | 12.77 | 2.05 |
| 300 | 30.22 | 33.87 | 18.09 | 14.67 | 1.07 | 0.67 | 25.61 | 12.62 | 2.09 |
| 320 | 30.05 | 33.78 | 17.59 | 14.74 | 1.07 | 0.67 | 25.62 | 12.78 | 2.07 |
| 340 | 29.86 | 33.65 | 18.21 | 14.83 | 1.07 | 0.66 | 25.64 | 12.88 | 2.09 |
| 360 | 29.67 | 33.55 | 18.04 | 14.89 | 1.08 | 0.65 | 25.62 | 12.83 | 2.17 |
| 380 | 29.49 | 33.38 | 17.84 | 14.93 | 1.08 | 0.65 | 25.62 | 12.92 | 2.18 |
| 400 | 29.28 | 33.20 | 18.60 | 15.03 | 1.08 | 0.65 | 25.57 | 12.87 | 2.18 |
| 420 | 29.11 | 33.08 | 18.15 | 15.04 | 1.08 | 0.64 | 25.50 | 12.89 | 2.19 |
| 440 | 28.89 | 32.94 | 18.11 | 15.10 | 1.08 | 0.64 | 25.48 | 12.89 | 2.20 |
| 460 | 28.72 | 32.80 | 18.18 | 15.21 | 1.08 | 0.63 | 25.67 | 12.92 | 2.24 |
| 480 | 28.54 | 32.64 | 18.07 | 15.26 | 1.08 | 0.63 | 25.66 | 12.89 | 2.28 |
| 500 | 28.37 | 32.48 | 18.44 | 15.34 | 1.09 | 0.63 | 25.79 | 12.95 | 2.29 |
| 520 | 28.20 | 32.34 | 17.71 | 15.34 | 1.08 | 0.63 | 25.94 | 12.99 | 2.29 |
| 540 | 27.96 | 32.12 | 17.87 | 15.31 | 1.08 | 0.62 | 25.96 | 13.01 | 2.27 |
| 560 | 27.82 | 31.98 | 17.88 | 15.39 | 1.08 | 0.62 | 25.93 | 13.00 | 2.32 |
| 580 | 27.65 | 31.80 | 18.22 | 15.32 | 1.08 | 0.62 | 25.97 | 12.97 | 2.34 |
| 600 | 27.51 | 31.60 | 18.03 | 15.37 | 1.08 | 0.63 | 26.11 | 13.08 | 2.33 |
| 620 | 27.28 | 31.45 | 17.86 | 15.38 | 1.08 | 0.62 | 26.11 | 13.07 | 2.31 |
| 640 | 27.13 | 31.28 | 18.23 | 15.45 | 1.08 | 0.62 | 26.06 | 13.00 | 2.29 |
| 660 | 26.97 | 31.12 | 18.29 | 15.43 | 1.08 | 0.62 | 26.22 | 13.02 | 2.35 |
| 680 | 26.77 | 30.93 | 18.39 | 15.49 | 1.08 | 0.62 | 26.32 | 13.07 | 2.33 |
| 700 | 26.61 | 30.75 | 17.98 | 15.45 | 1.08 | 0.62 | 26.39 | 13.11 | 2.31 |
| 750 | 26.22 | 30.37 | 18.05 | 15.44 | 1.07 | 0.61 | 26.33 | 13.24 | 2.34 |
| 800 | 25.82 | 29.89 | 18.27 | 15.32 | 1.07 | 0.62 | 26.24 | 13.11 | 2.40 |
| 850 | 25.44 | 29.51 | 18.32 | 15.31 | 1.07 | 0.62 | 26.16 | 13.25 | 2.36 |
| 900 | 25.05 | 29.08 | 18.31 | 15.25 | 1.06 | 0.62 | 25.82 | 13.25 | 2.33 |
| 940 | 24.71 | 28.71 | 18.58 | 15.10 | 1.06 | 0.62 | 25.99 | 13.23 | 2.40 |
| 1000 | 24.37 | 28.34 | 18.37 | 15.02 | 1.05 | 0.62 | 26.17 | 13.22 | 2.37 |

REV. X1
MAR-8ASM+
070829
Page 4 of 11



IF/RF MICROWAVE COMPONENTS • ISO 9001 ISO 14001 AS 9100 CERTIFIED • RoHS compliant

P.O. Box 350166, Brooklyn, New York 11235-0003 (718) 934-4500 Fax (718) 332-4661



The Design Engineers Search Engine finds the model you need, Instantly • For detailed performance specs & shopping online see



MMIC Amplifier

MAR-8ASM+

Typical Performance Data

Definitions:

Input Return Loss = -S11 (dB)

Gain(Power Gain) = S21 (dB)

Reverse Isolation = -S12 (dB)

Output Return Loss = -S22 (dB)

TEST CONDITIONS: Icc=29mA; Vcc=3.84V@Temp.= -45degC

| FREQ | Gain | Isolation | Input Return Loss | Output Return Loss | Stability | | IP3 Output | 1dB Comp. Output | Noise Figure |
|-------|-------|-----------|-------------------|--------------------|-----------|-------|------------|------------------|--------------|
| | | | | | K | Delta | | | |
| (MHz) | (dB) | (dB) | (dB) | (dB) | K | Delta | (dBm) | (dBm) | (dB) |
| 50 | 30.97 | 34.29 | 13.77 | 11.23 | 1.05 | 0.74 | 23.99 | 11.38 | 1.74 |
| 60 | 31.06 | 34.17 | 14.08 | 11.34 | 1.04 | 0.75 | 24.02 | 11.46 | 1.75 |
| 80 | 30.90 | 34.10 | 14.19 | 11.34 | 1.04 | 0.74 | 24.17 | 11.33 | 1.78 |
| 100 | 30.88 | 34.03 | 13.91 | 11.43 | 1.04 | 0.75 | 23.92 | 11.20 | 1.84 |
| 120 | 30.78 | 34.11 | 14.76 | 11.46 | 1.05 | 0.73 | 23.78 | 11.00 | 1.88 |
| 140 | 30.70 | 33.99 | 14.45 | 11.52 | 1.04 | 0.73 | 23.55 | 10.71 | 1.86 |
| 160 | 30.49 | 33.97 | 15.24 | 11.54 | 1.05 | 0.71 | 23.37 | 10.74 | 1.88 |
| 180 | 30.45 | 33.91 | 14.47 | 11.62 | 1.05 | 0.72 | 23.41 | 10.57 | 1.85 |
| 200 | 30.30 | 33.80 | 14.76 | 11.68 | 1.05 | 0.71 | 23.70 | 10.78 | 1.87 |
| 220 | 30.16 | 33.74 | 15.25 | 11.78 | 1.05 | 0.70 | 23.92 | 11.05 | 1.92 |
| 240 | 30.03 | 33.67 | 15.45 | 11.80 | 1.05 | 0.69 | 23.76 | 11.03 | 1.91 |
| 260 | 29.84 | 33.58 | 15.11 | 11.90 | 1.05 | 0.68 | 23.77 | 10.90 | 1.95 |
| 280 | 29.69 | 33.50 | 14.95 | 11.95 | 1.06 | 0.68 | 23.70 | 10.72 | 2.03 |
| 300 | 29.56 | 33.41 | 15.46 | 11.95 | 1.06 | 0.67 | 23.47 | 10.49 | 2.11 |
| 320 | 29.38 | 33.28 | 15.15 | 12.07 | 1.06 | 0.67 | 23.44 | 10.68 | 2.09 |
| 340 | 29.22 | 33.16 | 15.68 | 12.17 | 1.06 | 0.66 | 23.47 | 10.83 | 2.10 |
| 360 | 29.06 | 33.04 | 15.45 | 12.28 | 1.06 | 0.66 | 23.47 | 10.88 | 2.18 |
| 380 | 28.89 | 32.93 | 15.64 | 12.32 | 1.06 | 0.65 | 23.48 | 10.95 | 2.16 |
| 400 | 28.72 | 32.76 | 16.07 | 12.46 | 1.06 | 0.65 | 23.45 | 10.85 | 2.14 |
| 420 | 28.55 | 32.65 | 15.92 | 12.49 | 1.07 | 0.64 | 23.35 | 10.80 | 2.15 |
| 440 | 28.35 | 32.51 | 16.06 | 12.60 | 1.07 | 0.64 | 23.35 | 10.84 | 2.21 |
| 460 | 28.21 | 32.37 | 16.18 | 12.73 | 1.07 | 0.63 | 23.56 | 10.86 | 2.23 |
| 480 | 28.06 | 32.23 | 16.17 | 12.80 | 1.07 | 0.63 | 23.57 | 10.93 | 2.27 |
| 500 | 27.90 | 32.07 | 16.47 | 12.90 | 1.07 | 0.63 | 23.73 | 10.93 | 2.25 |
| 520 | 27.74 | 31.92 | 15.87 | 12.94 | 1.07 | 0.63 | 23.87 | 10.98 | 2.25 |
| 540 | 27.52 | 31.74 | 15.98 | 12.97 | 1.07 | 0.62 | 24.01 | 11.08 | 2.26 |
| 560 | 27.40 | 31.58 | 16.21 | 13.06 | 1.07 | 0.63 | 23.97 | 11.07 | 2.29 |
| 580 | 27.23 | 31.41 | 16.47 | 13.08 | 1.06 | 0.62 | 23.99 | 10.99 | 2.31 |
| 600 | 27.10 | 31.25 | 16.33 | 13.15 | 1.06 | 0.62 | 24.19 | 11.11 | 2.31 |
| 620 | 26.89 | 31.08 | 16.35 | 13.19 | 1.06 | 0.62 | 24.26 | 11.09 | 2.33 |
| 640 | 26.75 | 30.93 | 16.61 | 13.31 | 1.06 | 0.62 | 24.19 | 11.03 | 2.27 |
| 660 | 26.62 | 30.76 | 16.69 | 13.35 | 1.06 | 0.62 | 24.29 | 11.01 | 2.33 |
| 680 | 26.42 | 30.60 | 16.84 | 13.45 | 1.06 | 0.62 | 24.45 | 11.12 | 2.33 |
| 700 | 26.28 | 30.43 | 16.58 | 13.46 | 1.06 | 0.62 | 24.66 | 11.17 | 2.32 |
| 750 | 25.92 | 30.04 | 16.56 | 13.63 | 1.06 | 0.62 | 24.84 | 11.39 | 2.31 |
| 800 | 25.54 | 29.62 | 16.86 | 13.65 | 1.05 | 0.61 | 24.62 | 11.16 | 2.34 |
| 850 | 25.17 | 29.25 | 17.02 | 13.77 | 1.05 | 0.61 | 24.85 | 11.39 | 2.35 |
| 900 | 24.80 | 28.85 | 17.03 | 13.82 | 1.05 | 0.61 | 24.71 | 11.59 | 2.33 |
| 940 | 24.48 | 28.46 | 17.21 | 13.82 | 1.04 | 0.62 | 24.67 | 11.44 | 2.38 |
| 1000 | 24.16 | 28.11 | 17.06 | 13.85 | 1.04 | 0.61 | 25.13 | 11.56 | 2.35 |

REV. X1
MAR-8ASM+
070829
Page 5 of 11



IF/RF MICROWAVE COMPONENTS • ISO 9001 ISO 14001 AS 9100 CERTIFIED • RoHS compliant
P.O. Box 350166, Brooklyn, New York 11235-0003 (718) 934-4500 Fax (718) 332-4661



The Design Engineers Search Engine finds the model you need, Instantly • For detailed performance specs & shopping online see



MMIC Amplifier

MAR-8ASM+

Typical Performance Data

Definitions:

Input Return Loss = -S11 (dB)

Gain(Power Gain) = S21 (dB)

Reverse Isolation = -S12 (dB)

Output Return Loss = -S22 (dB)

TEST CONDITIONS: Icc=43mA; Vcc=4.02V@Temp.= -45degC

| FREQ | Gain | Isolation | Input Return Loss | Output Return Loss | Stability | | IP3 Output | 1dB Comp. Output | Noise Figure |
|-------|-------|-----------|-------------------|--------------------|-----------|-------|------------|------------------|--------------|
| | | | | | K | Delta | | | |
| (MHz) | (dB) | (dB) | (dB) | (dB) | K | Delta | (dBm) | (dBm) | (dB) |
| 50 | 32.55 | 35.22 | 19.79 | 17.05 | 1.04 | 0.75 | 27.35 | 14.18 | 1.78 |
| 60 | 32.57 | 35.25 | 20.73 | 17.11 | 1.04 | 0.75 | 27.27 | 14.19 | 1.78 |
| 80 | 32.42 | 35.13 | 20.81 | 17.12 | 1.04 | 0.74 | 27.29 | 14.14 | 1.84 |
| 100 | 32.38 | 35.10 | 20.82 | 17.24 | 1.04 | 0.74 | 27.11 | 14.11 | 1.94 |
| 120 | 32.24 | 35.04 | 21.20 | 17.24 | 1.05 | 0.74 | 27.02 | 14.12 | 1.92 |
| 140 | 32.12 | 35.01 | 20.10 | 17.30 | 1.05 | 0.73 | 26.89 | 14.07 | 1.85 |
| 160 | 31.83 | 34.92 | 23.03 | 17.29 | 1.06 | 0.71 | 26.85 | 14.07 | 1.95 |
| 180 | 31.80 | 34.83 | 20.50 | 17.35 | 1.05 | 0.72 | 26.99 | 14.02 | 1.89 |
| 200 | 31.61 | 34.73 | 19.99 | 17.35 | 1.06 | 0.71 | 27.28 | 14.06 | 2.00 |
| 220 | 31.42 | 34.70 | 21.39 | 17.44 | 1.06 | 0.70 | 27.45 | 14.10 | 1.96 |
| 240 | 31.25 | 34.62 | 20.21 | 17.36 | 1.07 | 0.69 | 27.35 | 14.06 | 1.97 |
| 260 | 31.05 | 34.52 | 20.16 | 17.40 | 1.07 | 0.68 | 27.35 | 14.08 | 2.01 |
| 280 | 30.85 | 34.38 | 19.60 | 17.41 | 1.07 | 0.68 | 27.49 | 14.09 | 2.05 |
| 300 | 30.68 | 34.26 | 19.83 | 17.33 | 1.08 | 0.67 | 27.43 | 14.06 | 2.13 |
| 320 | 30.48 | 34.16 | 19.54 | 17.35 | 1.08 | 0.67 | 27.42 | 14.14 | 2.11 |
| 340 | 30.28 | 34.02 | 19.92 | 17.38 | 1.08 | 0.66 | 27.39 | 14.11 | 2.14 |
| 360 | 30.06 | 33.88 | 19.71 | 17.40 | 1.08 | 0.65 | 27.30 | 14.04 | 2.20 |
| 380 | 29.87 | 33.75 | 19.36 | 17.35 | 1.09 | 0.65 | 27.25 | 14.11 | 2.20 |
| 400 | 29.64 | 33.56 | 20.02 | 17.42 | 1.09 | 0.64 | 27.17 | 14.14 | 2.22 |
| 420 | 29.46 | 33.39 | 19.80 | 17.35 | 1.09 | 0.64 | 27.08 | 14.16 | 2.23 |
| 440 | 29.22 | 33.25 | 19.57 | 17.37 | 1.09 | 0.64 | 27.06 | 14.21 | 2.26 |
| 460 | 29.06 | 33.11 | 19.68 | 17.41 | 1.09 | 0.63 | 27.19 | 14.16 | 2.26 |
| 480 | 28.87 | 32.96 | 19.39 | 17.43 | 1.09 | 0.63 | 27.12 | 14.15 | 2.30 |
| 500 | 28.68 | 32.76 | 19.70 | 17.45 | 1.09 | 0.63 | 27.19 | 14.18 | 2.31 |
| 520 | 28.50 | 32.58 | 18.72 | 17.35 | 1.09 | 0.63 | 27.23 | 14.16 | 2.29 |
| 540 | 28.26 | 32.40 | 19.31 | 17.27 | 1.09 | 0.62 | 27.24 | 14.14 | 2.29 |
| 560 | 28.11 | 32.21 | 19.25 | 17.27 | 1.09 | 0.63 | 27.19 | 14.13 | 2.34 |
| 580 | 27.93 | 32.05 | 19.36 | 17.11 | 1.09 | 0.62 | 27.20 | 14.14 | 2.34 |
| 600 | 27.76 | 31.86 | 18.99 | 17.09 | 1.09 | 0.62 | 27.27 | 14.17 | 2.35 |
| 620 | 27.54 | 31.69 | 18.98 | 17.04 | 1.09 | 0.62 | 27.22 | 14.16 | 2.36 |
| 640 | 27.37 | 31.51 | 19.18 | 17.03 | 1.09 | 0.62 | 27.21 | 14.17 | 2.33 |
| 660 | 27.20 | 31.29 | 19.06 | 16.94 | 1.09 | 0.62 | 27.35 | 14.20 | 2.38 |
| 680 | 27.01 | 31.12 | 19.41 | 16.97 | 1.09 | 0.62 | 27.39 | 14.22 | 2.37 |
| 700 | 26.85 | 30.97 | 18.97 | 16.84 | 1.08 | 0.62 | 27.31 | 14.18 | 2.34 |
| 750 | 26.43 | 30.55 | 19.05 | 16.74 | 1.08 | 0.62 | 27.04 | 14.07 | 2.36 |
| 800 | 26.01 | 30.10 | 19.23 | 16.48 | 1.08 | 0.62 | 27.05 | 14.21 | 2.41 |
| 850 | 25.61 | 29.68 | 19.31 | 16.32 | 1.07 | 0.62 | 26.78 | 14.11 | 2.38 |
| 900 | 25.21 | 29.25 | 19.23 | 16.13 | 1.07 | 0.62 | 26.35 | 13.88 | 2.37 |
| 940 | 24.86 | 28.87 | 19.45 | 15.90 | 1.07 | 0.62 | 26.65 | 14.15 | 2.43 |
| 1000 | 24.50 | 28.49 | 19.34 | 15.74 | 1.06 | 0.62 | 26.60 | 14.00 | 2.39 |

REV. X1
MAR-8ASM+
070829
Page 6 of 11



IF/RF MICROWAVE COMPONENTS • ISO 9001 ISO 14001 AS 9100 CERTIFIED • RoHS compliant
P.O. Box 350166, Brooklyn, New York 11235-0003 (718) 934-4500 Fax (718) 332-4661



The Design Engineers Search Engine finds the model you need, Instantly • For detailed performance specs & shopping online see



MMIC Amplifier

MAR-8ASM+

Typical Performance Data

Definitions:

Input Return Loss = -S11 (dB)

Gain(Power Gain) = S21 (dB)

Reverse Isolation = -S12 (dB)

Output Return Loss = -S22 (dB)

TEST CONDITIONS: Icc=36mA; Vcc=3.91V@Temp.=+85degC

| FREQ | Gain | Isolation | Input Return Loss | Output Return Loss | Stability | | IP3 Output | 1dB Comp. Output | Noise Figure |
|-------|-------|-----------|-------------------|--------------------|-----------|-------|------------|------------------|--------------|
| | | | | | K | Delta | | | |
| (MHz) | (dB) | (dB) | (dB) | (dB) | K | Delta | (dBm) | (dBm) | (dB) |
| 50 | 30.75 | 33.98 | 13.16 | 10.46 | 1.04 | 0.75 | 26.80 | 12.53 | 2.54 |
| 60 | 30.82 | 34.05 | 13.80 | 10.55 | 1.04 | 0.75 | 26.91 | 12.57 | 2.56 |
| 80 | 30.69 | 34.12 | 13.50 | 10.66 | 1.05 | 0.74 | 27.14 | 12.52 | 2.59 |
| 100 | 30.66 | 34.00 | 12.90 | 10.77 | 1.04 | 0.74 | 26.83 | 12.47 | 2.65 |
| 120 | 30.55 | 33.87 | 13.93 | 10.83 | 1.04 | 0.74 | 26.54 | 12.48 | 2.66 |
| 140 | 30.44 | 34.00 | 13.32 | 10.86 | 1.05 | 0.72 | 26.26 | 12.54 | 2.67 |
| 160 | 30.23 | 33.93 | 14.10 | 10.88 | 1.05 | 0.70 | 26.02 | 12.48 | 2.68 |
| 180 | 30.17 | 33.84 | 13.45 | 10.97 | 1.05 | 0.71 | 26.00 | 12.44 | 2.67 |
| 200 | 30.02 | 33.75 | 13.62 | 11.05 | 1.05 | 0.70 | 26.19 | 12.45 | 2.68 |
| 220 | 29.86 | 33.73 | 14.09 | 11.12 | 1.06 | 0.69 | 26.33 | 12.42 | 2.76 |
| 240 | 29.72 | 33.63 | 14.31 | 11.15 | 1.06 | 0.68 | 26.16 | 12.40 | 2.75 |
| 260 | 29.52 | 33.61 | 14.08 | 11.25 | 1.07 | 0.67 | 26.26 | 12.40 | 2.84 |
| 280 | 29.33 | 33.50 | 13.76 | 11.29 | 1.07 | 0.66 | 26.29 | 12.34 | 2.89 |
| 300 | 29.18 | 33.45 | 14.07 | 11.35 | 1.07 | 0.65 | 25.98 | 12.26 | 2.97 |
| 320 | 29.01 | 33.27 | 13.80 | 11.43 | 1.07 | 0.65 | 25.82 | 12.31 | 2.94 |
| 340 | 28.83 | 33.21 | 14.53 | 11.51 | 1.08 | 0.64 | 25.74 | 12.31 | 2.95 |
| 360 | 28.66 | 33.09 | 14.24 | 11.61 | 1.08 | 0.63 | 25.66 | 12.28 | 3.05 |
| 380 | 28.48 | 32.98 | 14.18 | 11.68 | 1.08 | 0.63 | 25.61 | 12.28 | 3.02 |
| 400 | 28.30 | 32.89 | 14.62 | 11.77 | 1.08 | 0.61 | 25.54 | 12.27 | 3.05 |
| 420 | 28.11 | 32.73 | 14.55 | 11.84 | 1.08 | 0.61 | 25.45 | 12.36 | 3.06 |
| 440 | 27.89 | 32.57 | 14.59 | 11.91 | 1.09 | 0.61 | 25.41 | 12.29 | 3.06 |
| 460 | 27.74 | 32.47 | 14.67 | 12.01 | 1.09 | 0.60 | 25.59 | 12.31 | 3.12 |
| 480 | 27.57 | 32.32 | 14.69 | 12.10 | 1.09 | 0.60 | 25.56 | 12.23 | 3.16 |
| 500 | 27.38 | 32.17 | 14.91 | 12.21 | 1.09 | 0.59 | 25.65 | 12.30 | 3.20 |
| 520 | 27.21 | 32.00 | 14.41 | 12.24 | 1.09 | 0.59 | 25.74 | 12.29 | 3.17 |
| 540 | 27.00 | 31.85 | 14.53 | 12.33 | 1.09 | 0.58 | 25.82 | 12.26 | 3.18 |
| 560 | 26.85 | 31.70 | 14.62 | 12.43 | 1.09 | 0.58 | 25.75 | 12.27 | 3.25 |
| 580 | 26.69 | 31.55 | 14.84 | 12.44 | 1.09 | 0.58 | 25.73 | 12.27 | 3.24 |
| 600 | 26.54 | 31.39 | 14.75 | 12.53 | 1.09 | 0.58 | 25.86 | 12.23 | 3.24 |
| 620 | 26.32 | 31.20 | 14.71 | 12.57 | 1.09 | 0.57 | 25.85 | 12.26 | 3.24 |
| 640 | 26.19 | 31.06 | 14.77 | 12.67 | 1.09 | 0.57 | 25.80 | 12.28 | 3.24 |
| 660 | 26.04 | 30.88 | 14.95 | 12.67 | 1.08 | 0.57 | 25.94 | 12.23 | 3.29 |
| 680 | 25.86 | 30.71 | 15.06 | 12.76 | 1.08 | 0.57 | 25.99 | 12.27 | 3.31 |
| 700 | 25.67 | 30.58 | 14.87 | 12.79 | 1.08 | 0.56 | 26.02 | 12.27 | 3.26 |
| 750 | 25.32 | 30.17 | 14.93 | 12.91 | 1.08 | 0.56 | 25.83 | 12.23 | 3.28 |
| 800 | 24.91 | 29.74 | 15.14 | 12.98 | 1.07 | 0.56 | 25.67 | 12.27 | 3.33 |
| 850 | 24.54 | 29.37 | 15.20 | 13.09 | 1.07 | 0.56 | 25.45 | 12.19 | 3.32 |
| 900 | 24.15 | 28.97 | 15.13 | 13.13 | 1.07 | 0.55 | 24.99 | 12.05 | 3.34 |
| 940 | 23.79 | 28.58 | 15.41 | 13.15 | 1.07 | 0.55 | 25.17 | 12.22 | 3.37 |
| 1000 | 23.44 | 28.22 | 15.27 | 13.16 | 1.06 | 0.55 | 25.21 | 12.11 | 3.36 |

REV. X1
MAR-8ASM+
070829
Page 7 of 11



IF/RF MICROWAVE COMPONENTS • ISO 9001 ISO 14001 AS 9100 CERTIFIED • RoHS compliant
P.O. Box 350166, Brooklyn, New York 11235-0003 (718) 934-4500 Fax (718) 332-4661



The Design Engineers Search Engine finds the model you need, Instantly • For detailed performance specs & shopping online see



MMIC Amplifier

MAR-8ASM+

Typical Performance Data

Definitions:

Input Return Loss = -S11 (dB)

Gain(Power Gain) = S21 (dB)

Reverse Isolation = -S12 (dB)

Output Return Loss = -S22 (dB)

TEST CONDITIONS: Icc=29mA; Vcc=3.81V@Temp.=+85degC

| FREQ | Gain | Isolation | Input Return Loss | Output Return Loss | Stability | | IP3 Output | 1dB Comp. Output | Noise Figure |
|-------|-------|-----------|-------------------|--------------------|-----------|-------|------------|------------------|--------------|
| | | | | | K | Delta | | | |
| (MHz) | (dB) | (dB) | (dB) | (dB) | K | Delta | (dBm) | (dBm) | (dB) |
| 50 | 29.62 | 33.72 | 10.65 | 8.51 | 1.05 | 0.73 | 25.51 | 10.96 | 2.53 |
| 60 | 29.76 | 33.68 | 11.13 | 8.57 | 1.04 | 0.74 | 25.62 | 11.02 | 2.55 |
| 80 | 29.63 | 33.57 | 11.30 | 8.62 | 1.05 | 0.74 | 25.91 | 10.90 | 2.57 |
| 100 | 29.64 | 33.55 | 11.04 | 8.72 | 1.04 | 0.74 | 25.59 | 10.94 | 2.64 |
| 120 | 29.57 | 33.46 | 11.62 | 8.76 | 1.04 | 0.73 | 25.28 | 10.71 | 2.64 |
| 140 | 29.46 | 33.36 | 11.40 | 8.82 | 1.04 | 0.73 | 24.97 | 10.51 | 2.65 |
| 160 | 29.27 | 33.38 | 11.99 | 8.85 | 1.05 | 0.71 | 24.66 | 10.52 | 2.65 |
| 180 | 29.21 | 33.34 | 11.48 | 8.93 | 1.05 | 0.71 | 24.59 | 10.43 | 2.62 |
| 200 | 29.08 | 33.26 | 11.59 | 8.97 | 1.05 | 0.70 | 24.74 | 10.46 | 2.66 |
| 220 | 28.96 | 33.13 | 11.98 | 9.07 | 1.05 | 0.69 | 24.88 | 10.66 | 2.74 |
| 240 | 28.82 | 33.13 | 11.88 | 9.08 | 1.05 | 0.68 | 24.65 | 10.63 | 2.74 |
| 260 | 28.66 | 33.00 | 11.75 | 9.18 | 1.05 | 0.68 | 24.77 | 10.59 | 2.82 |
| 280 | 28.49 | 33.01 | 11.80 | 9.25 | 1.05 | 0.66 | 24.75 | 10.29 | 2.85 |
| 300 | 28.38 | 32.86 | 12.12 | 9.30 | 1.05 | 0.66 | 24.33 | 10.07 | 2.94 |
| 320 | 28.22 | 32.76 | 12.06 | 9.38 | 1.05 | 0.65 | 24.10 | 10.34 | 2.93 |
| 340 | 28.07 | 32.66 | 12.51 | 9.49 | 1.06 | 0.64 | 23.98 | 10.38 | 2.94 |
| 360 | 27.91 | 32.53 | 12.43 | 9.58 | 1.05 | 0.64 | 23.87 | 10.35 | 3.00 |
| 380 | 27.74 | 32.45 | 12.56 | 9.65 | 1.06 | 0.63 | 23.84 | 10.44 | 2.99 |
| 400 | 27.58 | 32.29 | 12.81 | 9.77 | 1.06 | 0.62 | 23.78 | 10.40 | 3.01 |
| 420 | 27.44 | 32.19 | 12.70 | 9.86 | 1.06 | 0.62 | 23.65 | 10.23 | 3.02 |
| 440 | 27.24 | 32.05 | 12.97 | 9.93 | 1.06 | 0.61 | 23.59 | 10.31 | 3.05 |
| 460 | 27.11 | 31.93 | 12.96 | 10.03 | 1.06 | 0.61 | 23.83 | 10.34 | 3.14 |
| 480 | 26.96 | 31.78 | 13.00 | 10.11 | 1.06 | 0.60 | 23.80 | 10.28 | 3.13 |
| 500 | 26.81 | 31.64 | 13.27 | 10.23 | 1.06 | 0.60 | 23.89 | 10.32 | 3.15 |
| 520 | 26.62 | 31.56 | 12.88 | 10.28 | 1.06 | 0.59 | 24.03 | 10.30 | 3.18 |
| 540 | 26.45 | 31.36 | 13.05 | 10.30 | 1.06 | 0.59 | 24.14 | 10.43 | 3.19 |
| 560 | 26.32 | 31.23 | 13.23 | 10.41 | 1.06 | 0.59 | 24.07 | 10.42 | 3.24 |
| 580 | 26.19 | 31.07 | 13.43 | 10.47 | 1.06 | 0.58 | 24.10 | 10.30 | 3.23 |
| 600 | 26.04 | 30.92 | 13.28 | 10.58 | 1.06 | 0.58 | 24.28 | 10.52 | 3.22 |
| 620 | 25.85 | 30.77 | 13.29 | 10.64 | 1.06 | 0.58 | 24.35 | 10.49 | 3.23 |
| 640 | 25.73 | 30.61 | 13.50 | 10.75 | 1.05 | 0.58 | 24.26 | 10.38 | 3.22 |
| 660 | 25.56 | 30.45 | 13.55 | 10.79 | 1.05 | 0.57 | 24.34 | 10.43 | 3.25 |
| 680 | 25.41 | 30.29 | 13.75 | 10.89 | 1.05 | 0.57 | 24.48 | 10.48 | 3.28 |
| 700 | 25.26 | 30.15 | 13.57 | 10.96 | 1.05 | 0.57 | 24.66 | 10.56 | 3.23 |
| 750 | 24.90 | 29.78 | 13.56 | 11.25 | 1.05 | 0.56 | 24.68 | 10.72 | 3.27 |
| 800 | 24.54 | 29.35 | 13.85 | 11.33 | 1.04 | 0.56 | 24.47 | 10.55 | 3.31 |
| 850 | 24.17 | 28.97 | 13.98 | 11.53 | 1.04 | 0.56 | 24.46 | 10.72 | 3.33 |
| 900 | 23.82 | 28.60 | 13.92 | 11.68 | 1.04 | 0.55 | 24.19 | 10.92 | 3.32 |
| 940 | 23.49 | 28.23 | 14.23 | 11.78 | 1.04 | 0.55 | 24.21 | 10.83 | 3.34 |
| 1000 | 23.17 | 27.87 | 14.09 | 11.87 | 1.03 | 0.55 | 24.50 | 10.89 | 3.33 |

REV. X1
MAR-8ASM+
070829
Page 8 of 11



IF/RF MICROWAVE COMPONENTS • ISO 9001 ISO 14001 AS 9100 CERTIFIED • RoHS compliant
P.O. Box 350166, Brooklyn, New York 11235-0003 (718) 934-4500 Fax (718) 332-4661



The Design Engineers Search Engine finds the model you need, Instantly • For detailed performance specs & shopping online see



MMIC Amplifier

MAR-8ASM+

Typical Performance Data

Definitions:

Input Return Loss = -S11 (dB)

Gain(Power Gain) = S21 (dB)

Reverse Isolation = -S12 (dB)

Output Return Loss = -S22 (dB)

TEST CONDITIONS: Icc=43mA; Vcc=3.99V@Temp.=+85degC

| FREQ | Gain | Isolation | Input Return Loss | Output Return Loss | Stability | | IP3 Output | 1dB Comp. Output | Noise Figure |
|-------|-------|-----------|-------------------|--------------------|-----------|-------|------------|------------------|--------------|
| | | | | | K | Delta | | | |
| (MHz) | (dB) | (dB) | (dB) | (dB) | K | Delta | (dBm) | (dBm) | (dB) |
| 50 | 31.52 | 34.41 | 15.29 | 12.53 | 1.04 | 0.76 | 28.14 | 13.11 | 2.58 |
| 60 | 31.57 | 34.48 | 16.13 | 12.61 | 1.04 | 0.75 | 28.21 | 13.12 | 2.60 |
| 80 | 31.44 | 34.46 | 15.53 | 12.67 | 1.04 | 0.74 | 28.39 | 13.08 | 2.62 |
| 100 | 31.38 | 34.42 | 15.02 | 12.84 | 1.04 | 0.74 | 28.09 | 13.05 | 2.70 |
| 120 | 31.27 | 34.39 | 16.20 | 12.89 | 1.05 | 0.73 | 27.83 | 13.11 | 2.72 |
| 140 | 31.14 | 34.34 | 15.57 | 12.92 | 1.05 | 0.73 | 27.54 | 13.24 | 2.69 |
| 160 | 30.89 | 34.27 | 16.67 | 12.96 | 1.05 | 0.71 | 27.34 | 13.28 | 2.70 |
| 180 | 30.84 | 34.26 | 15.40 | 13.04 | 1.06 | 0.71 | 27.37 | 13.13 | 2.70 |
| 200 | 30.66 | 34.22 | 15.72 | 13.09 | 1.06 | 0.70 | 27.58 | 12.92 | 2.69 |
| 220 | 30.47 | 34.14 | 16.32 | 13.20 | 1.07 | 0.68 | 27.67 | 12.84 | 2.77 |
| 240 | 30.32 | 34.06 | 16.11 | 13.20 | 1.07 | 0.68 | 27.49 | 12.77 | 2.78 |
| 260 | 30.13 | 34.02 | 15.58 | 13.28 | 1.07 | 0.67 | 27.58 | 12.88 | 2.85 |
| 280 | 29.93 | 33.92 | 15.72 | 13.30 | 1.08 | 0.66 | 27.70 | 13.05 | 2.92 |
| 300 | 29.77 | 33.85 | 15.81 | 13.31 | 1.08 | 0.65 | 27.51 | 13.07 | 2.97 |
| 320 | 29.55 | 33.72 | 15.60 | 13.39 | 1.08 | 0.64 | 27.34 | 12.94 | 2.95 |
| 340 | 29.36 | 33.60 | 15.99 | 13.48 | 1.09 | 0.64 | 27.26 | 12.81 | 2.98 |
| 360 | 29.16 | 33.54 | 15.82 | 13.56 | 1.09 | 0.62 | 27.11 | 12.71 | 3.05 |
| 380 | 28.96 | 33.40 | 15.78 | 13.58 | 1.10 | 0.62 | 27.06 | 12.77 | 3.06 |
| 400 | 28.76 | 33.23 | 16.25 | 13.67 | 1.10 | 0.61 | 26.96 | 12.87 | 3.09 |
| 420 | 28.58 | 33.11 | 16.10 | 13.72 | 1.10 | 0.61 | 26.84 | 12.86 | 3.08 |
| 440 | 28.35 | 32.98 | 15.93 | 13.77 | 1.10 | 0.60 | 26.80 | 12.86 | 3.10 |
| 460 | 28.18 | 32.80 | 16.03 | 13.82 | 1.10 | 0.60 | 26.95 | 12.81 | 3.16 |
| 480 | 27.99 | 32.68 | 15.94 | 13.90 | 1.10 | 0.59 | 26.85 | 12.81 | 3.19 |
| 500 | 27.79 | 32.50 | 16.16 | 13.98 | 1.11 | 0.59 | 26.92 | 12.76 | 3.22 |
| 520 | 27.60 | 32.37 | 15.56 | 13.99 | 1.10 | 0.59 | 26.95 | 12.72 | 3.22 |
| 540 | 27.40 | 32.20 | 15.76 | 13.99 | 1.10 | 0.58 | 26.94 | 12.72 | 3.23 |
| 560 | 27.22 | 32.01 | 15.84 | 14.04 | 1.10 | 0.58 | 26.88 | 12.71 | 3.29 |
| 580 | 27.03 | 31.85 | 15.99 | 14.02 | 1.10 | 0.58 | 26.87 | 12.69 | 3.26 |
| 600 | 26.88 | 31.69 | 15.78 | 14.09 | 1.10 | 0.58 | 26.89 | 12.68 | 3.28 |
| 620 | 26.66 | 31.52 | 15.74 | 14.10 | 1.10 | 0.57 | 26.85 | 12.71 | 3.28 |
| 640 | 26.50 | 31.35 | 15.81 | 14.16 | 1.10 | 0.57 | 26.79 | 12.75 | 3.26 |
| 660 | 26.33 | 31.16 | 15.92 | 14.12 | 1.10 | 0.57 | 26.91 | 12.77 | 3.32 |
| 680 | 26.13 | 30.98 | 16.09 | 14.17 | 1.10 | 0.57 | 26.91 | 12.76 | 3.32 |
| 700 | 25.99 | 30.86 | 15.85 | 14.18 | 1.10 | 0.57 | 26.83 | 12.71 | 3.29 |
| 750 | 25.57 | 30.41 | 15.92 | 14.26 | 1.10 | 0.56 | 26.49 | 12.57 | 3.29 |
| 800 | 25.13 | 29.99 | 16.05 | 14.15 | 1.09 | 0.56 | 26.36 | 12.73 | 3.38 |
| 850 | 24.75 | 29.59 | 16.09 | 14.21 | 1.09 | 0.56 | 25.99 | 12.54 | 3.37 |
| 900 | 24.35 | 29.19 | 16.01 | 14.17 | 1.09 | 0.55 | 25.47 | 12.31 | 3.35 |
| 940 | 23.98 | 28.81 | 16.30 | 14.11 | 1.08 | 0.55 | 25.69 | 12.57 | 3.38 |
| 1000 | 23.62 | 28.42 | 16.07 | 14.05 | 1.08 | 0.55 | 25.64 | 12.43 | 3.38 |

REV. X1
MAR-8ASM+
070829
Page 9 of 11



IF/RF MICROWAVE COMPONENTS • ISO 9001 ISO 14001 AS 9100 CERTIFIED • RoHS compliant
P.O. Box 350166, Brooklyn, New York 11235-0003 (718) 934-4500 Fax (718) 332-4661



The Design Engineers Search Engine finds the model you need, Instantly • For detailed performance specs & shopping online see



Typical Performance Curves

GAIN vs. TEMPERATURE

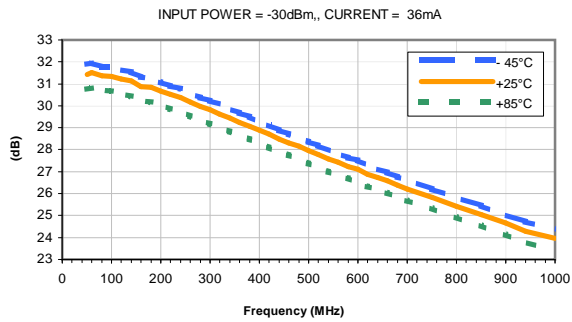

GAIN vs. CURRENT

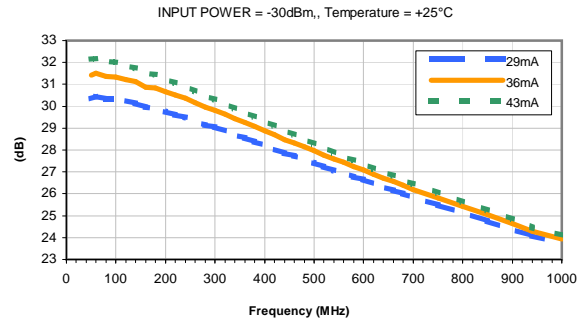

ISOLATION vs. TEMPERATURE

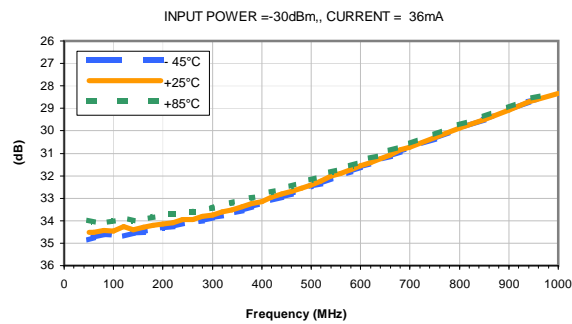

ISOLATION vs. CURRENT

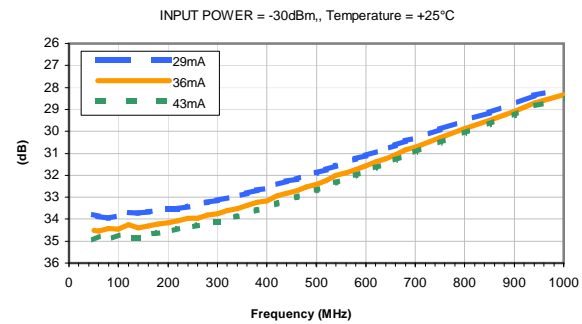

INPUT RETURN LOSS vs. TEMPERATURE

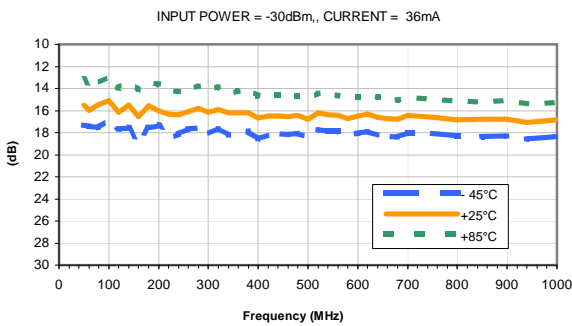

INPUT RETURN LOSS vs. CURRENT

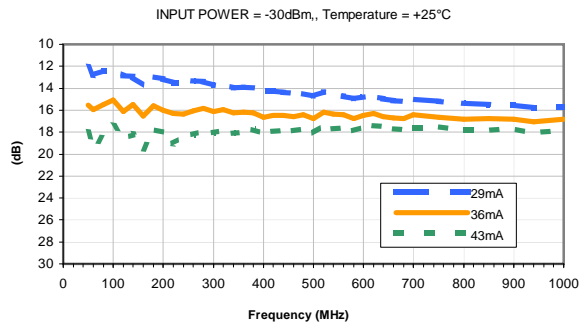

OUTPUT RETURN LOSS vs. TEMPERATURE

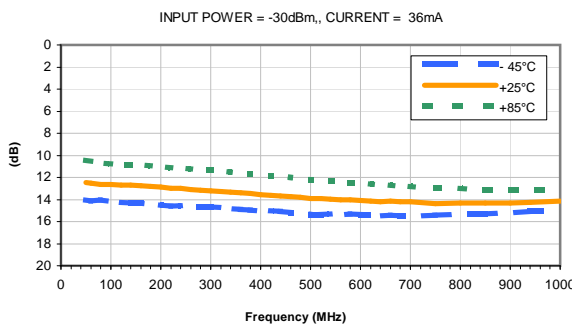

OUTPUT RETURN LOSS vs. CURRENT

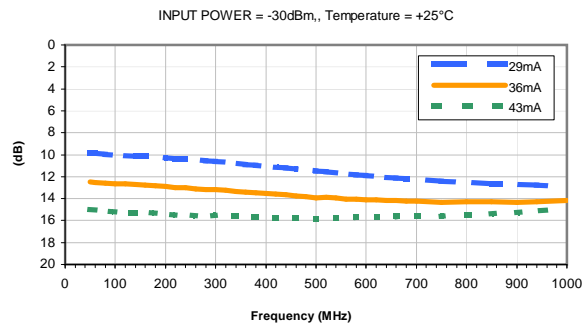

Typical Performance Curves

OUTPUT IP3 vs. TEMPERATURE

INPUT POWER = -30dBm, CURRENT = 36mA

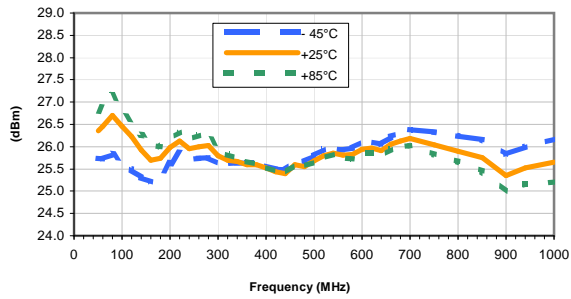

OUTPUT IP-3 vs. CURRENT

INPUT POWER = -30dBm, Temperature = +25°C

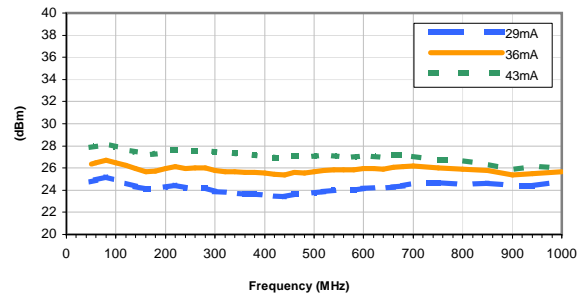

OUTPUT POWER at 1dB Compression vs. TEMPERATURE

CURRENT = 36mA

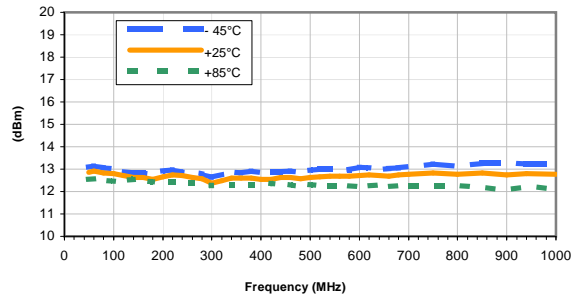

OUTPUT POWER at 1dB Compression vs. CURRENT

Temperature = +25°C

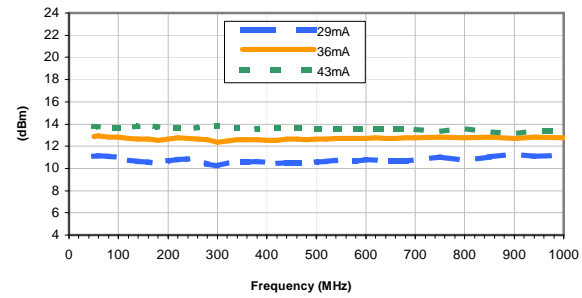

Noise Figure vs. TEMPERATURE

CURRENT = 36mA

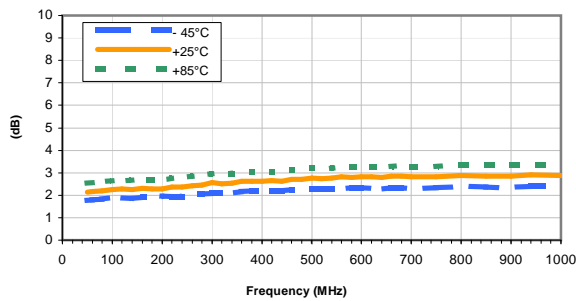

Noise Figure vs. CURRENT

Temperature = +25°C

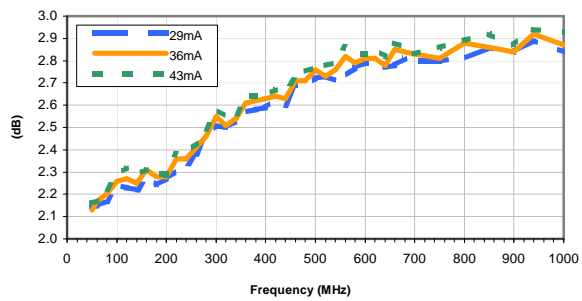

IF/RF MICROWAVE COMPONENTS • ISO 9001 ISO 14001 AS 9100 CERTIFIED RoHS compliant
 P.O. Box 350166, Brooklyn, New York 11235-0003 (718) 934-4500 Fax (718) 332-4661



The Design Engineers Search Engine finds the model you need, Instantly • For detailed performance specs & shopping online see



Typical Performance Curves

GAIN vs. TEMPERATURE

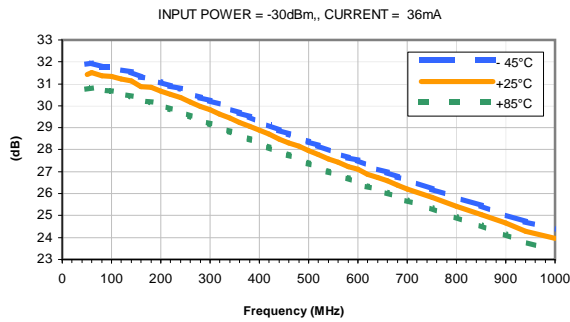

GAIN vs. CURRENT

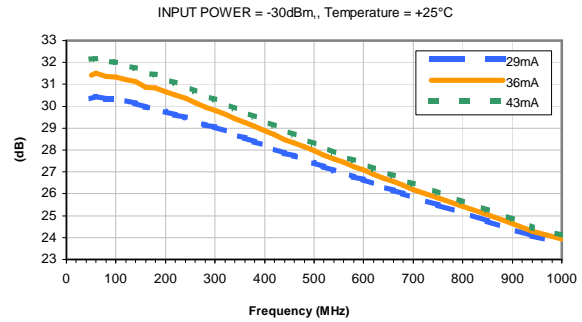

ISOLATION vs. TEMPERATURE

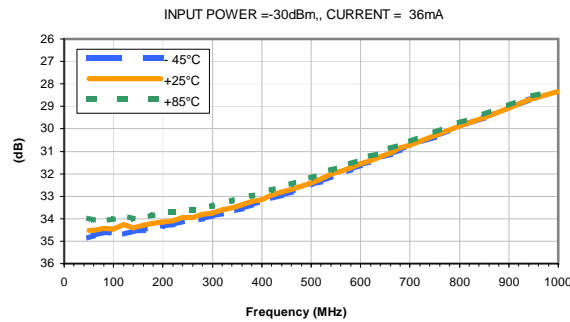

ISOLATION vs. CURRENT

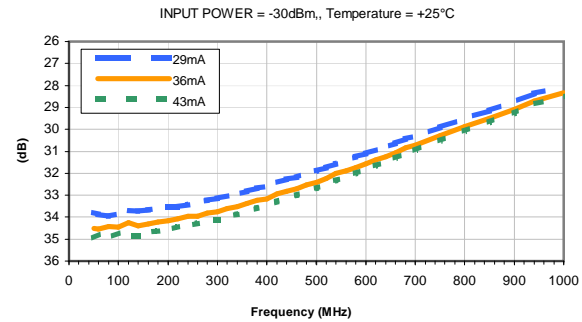

INPUT RETURN LOSS vs. TEMPERATURE

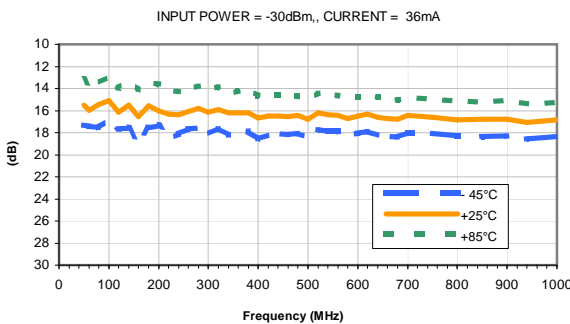

INPUT RETURN LOSS vs. CURRENT

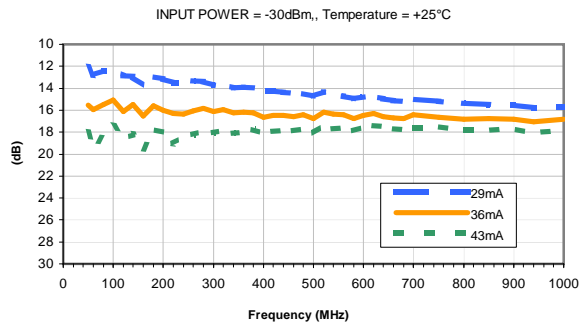

OUTPUT RETURN LOSS vs. TEMPERATURE

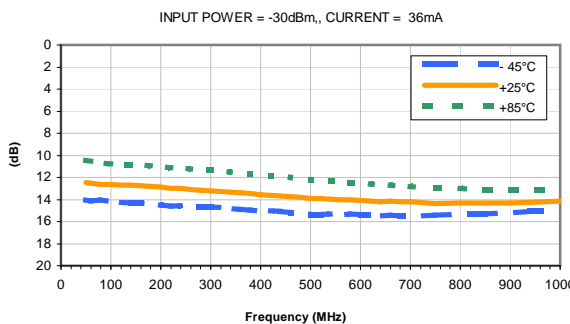

OUTPUT RETURN LOSS vs. CURRENT

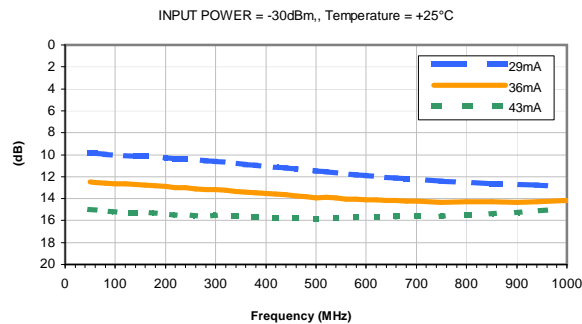

Typical Performance Curves

OUTPUT IP3 vs. TEMPERATURE

INPUT POWER = -30dBm, CURRENT = 36mA

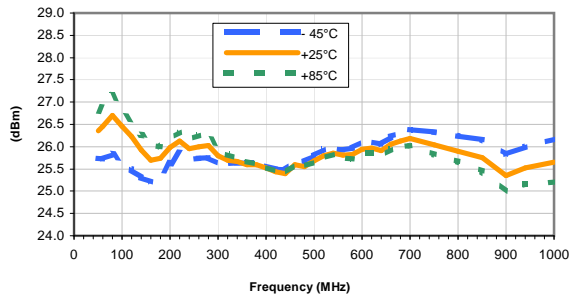

OUTPUT IP-3 vs. CURRENT

INPUT POWER = -30dBm, Temperature = +25°C

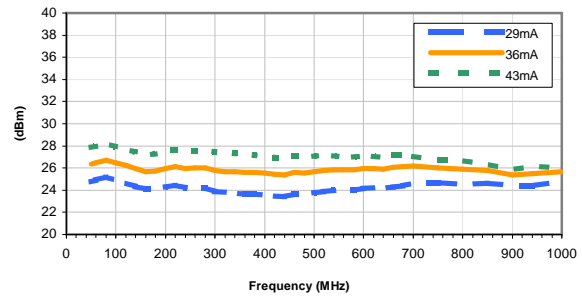

OUTPUT POWER at 1dB Compression vs. TEMPERATURE

CURRENT = 36mA

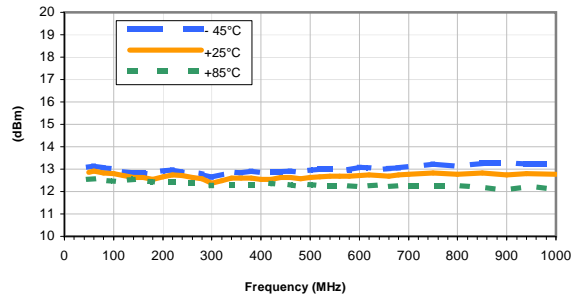

OUTPUT POWER at 1dB Compression vs. CURRENT

Temperature = +25°C

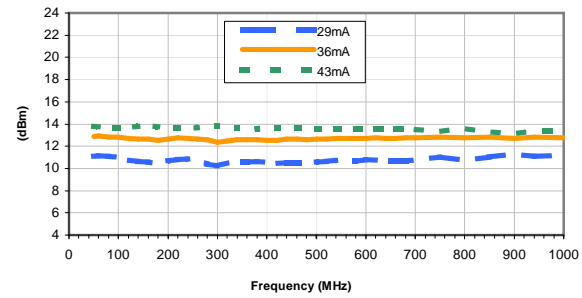

Noise Figure vs. TEMPERATURE

CURRENT = 36mA

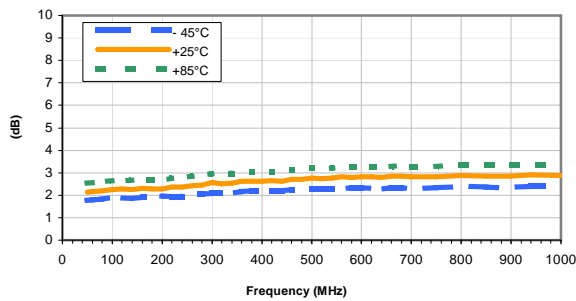

Noise Figure vs. CURRENT

Temperature = +25°C

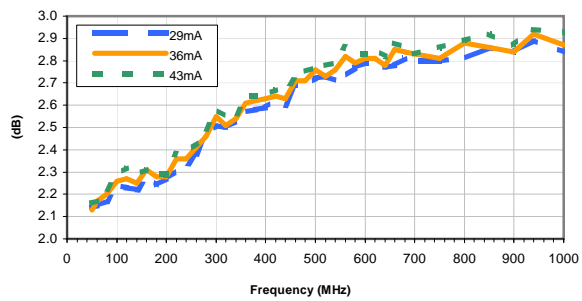

Outline Dimensions

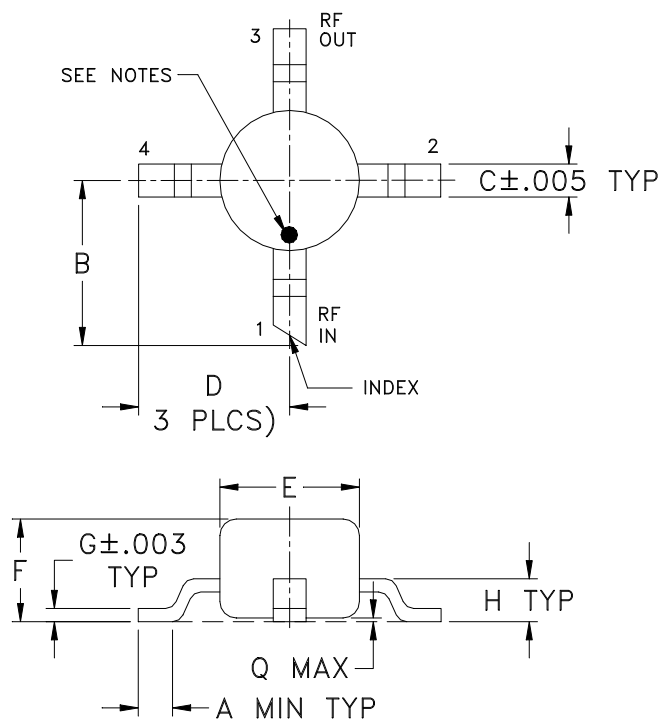

PCB Land Pattern

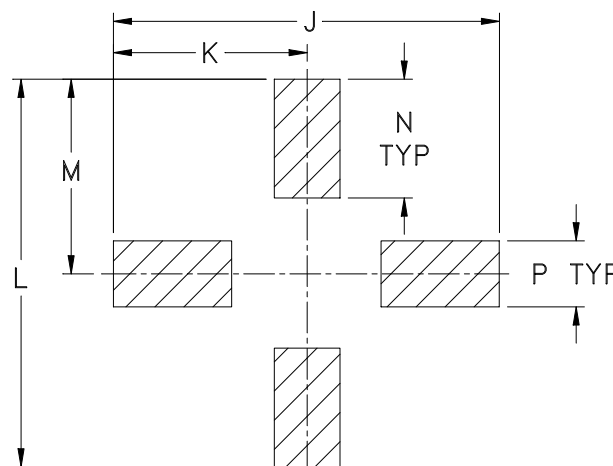

Suggested Layout,
Tolerance to be within $\pm .002$

| CASE# | A | B | C | D | E | F | G | H | J | K | L | M | N | P | Q | WT. GRAMS |
|-------|----------------|---------------|----------------|----------------|----------------|----------------|----------------|----------------|----------------|----------------|----------------|----------------|----------------|----------------|----------------|-----------|
| WW107 | .012 (0.30) | .10 (2.54) | .020 (0.51) | .092 (2.34) | .085 (2.16) | .060 (1.52) | .007 (0.18) | .026 (0.66) | .235 (5.97) | .118 (3.00) | .235 (5.97) | .118 (3.00) | .072 (1.83) | .040 (1.02) | .020 (0.51) | .015 |

Dimensions are in inches (mm). Tolerances: 2 Pl. $\pm .03$; 3 Pl. $\pm .015$

Notes:

- Case material: Plastic.
- Termination finish:
For RoHS Case Styles: Matte tin Plate.
For RoHS-5 Case Styles: Tin-Lead plate.
- RF input termination (1) identified by one or both of the following at factory option:
 - diagonally cut termination, which may be 45° (ref) in either direction;
 - orientation mark on the case. Model dash number is identified by color dot or alphanumeric code on case. See specification data sheet.



INTERNET <http://www.minicircuits.com>

P.O. Box 350166, Brooklyn, New York 11235-0003 (718) 934-4500

Distribution Centers NORTH AMERICA 800-654-7949 • 417-335-5935 • Fax 417-335-5945 • EUROPE 44-1252-1

Mini-Circuits ISO 9001 & ISO 14001 Certified

Tape & Reel Packaging TR-F4

DEVICE ORIENTATION IN T&R

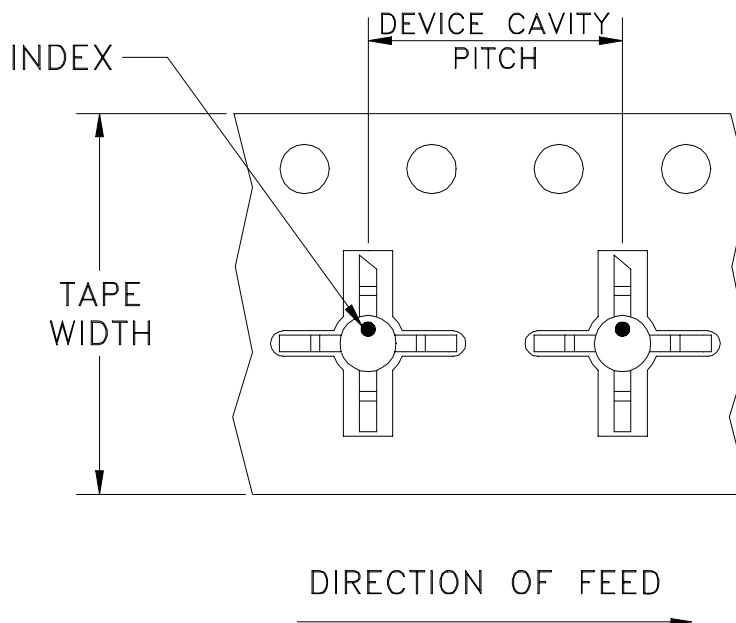

| Tape Width, mm | Device Cavity Pitch, mm | Reel Size, inches | Devices per Reel | |
|----------------|-------------------------|-------------------|-------------------------------------|------|
| 12 | 8 | 7 | Small quantity standards (see note) | 20 |
| | | | | 50 |
| | | | | 100 |
| | | | | 200 |
| | | | | 500 |
| | | 7 | Standard | 1000 |

Note: Please Consult individual model data sheet to determine device per reel availability.

Mini-Circuits carrier tape materials provide protection from ESD (Electro-Static Discharge) during handling and transportation. Tapes are static dissipative and comply with industry standards EIA-481/EIA-541.

Go to: www.minicircuits.com/pages/pdfs/tape.pdf



INTERNET <http://www.minicircuits.com>

P.O. Box 350166, Brooklyn, New York 11235-0003 (718) 934-4500 Fax (718) 332-4661

Distribution Centers NORTH AMERICA 800-654-7949 • 417-335-5935 • Fax 417-335-5945 • EUROPE 44-1252-832600 • Fax 44-1252-837010

Mini-Circuits ISO 9001 & ISO 14001 Certified

THIRD ANGLE PROJECTION

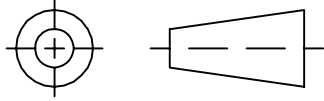

REVISIONS

| REV OR | ECN No. | DESCRIPTION | DATE | DR | AUTH |
|--------|---------|-------------|----------|----|------|
| | M108436 | NEW RELEASE | 11/14/06 | PW | IG |
| | | | | | |
| | | | | | |

SUGGESTED MOUNTING CONFIGURATION FOR WW107 CASE STYLE, "cb" PIN CONNECTION

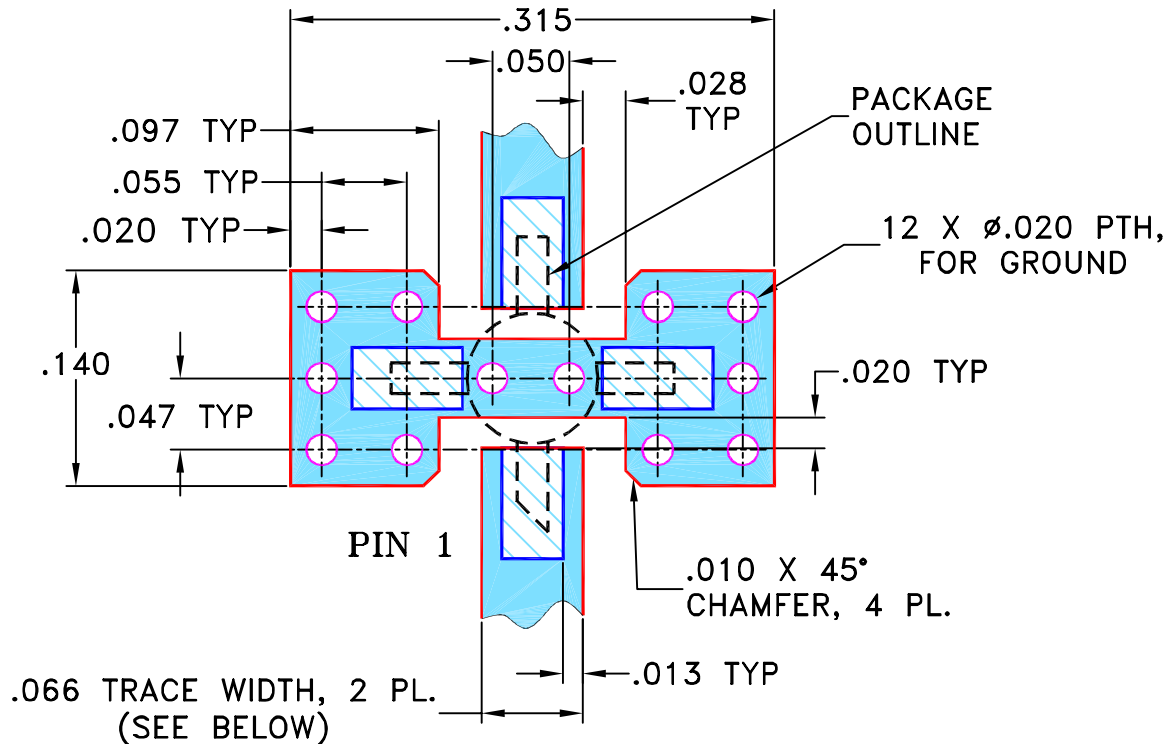

NOTES:

1. TRACE WIDTH IS SHOWN FOR ROGERS R04350B WITH DIELECTRIC THICKNESS .030" ± .002"; COPPER: 1/2 OZ. EACH SIDE. FOR OTHER MATERIALS TRACE WIDTH MAY NEED TO BE MODIFIED.
2. BOTTOM SIDE OF THE PCB IS CONTINUOUS GROUND PLANE.
3. IF PCB DESIGN RULES ALLOW, PLACE GROUND VIAS UNDER THE LAND PATTERN FOR BETTER RF PERFORMANCE. OTHERWISE PLACE GROUND VIAS AS CLOSE TO LAND PATTERN AS POSSIBLE.

- DENOTES PCB COPPER LAYOUT WITH SMOBC (SOLDER MASK OVER BARE COPPER)
- DENOTES COPPER LAND PATTERN FREE OF SOLDER MASK

| UNLESS OTHERWISE SPECIFIED | INITIALS | DATE |
|--|----------|-------------|
| DIMENSIONS ARE IN INCHES TOLERANCES ON: 2 PL DECIMALS ± 3 PL DECIMALS ± .005 ANGLES ± FRACTIONS ± | DRAWN | PW 11/11/06 |
| | CHECKED | IL 11/14/06 |
| | APPROVED | IG 11/14/06 |

Mini-Circuits® 13 Neptune Avenue
Brooklyn NY 11235

PL, cb, WW107, MAR, TB-411-XX+

Mini-Circuits®
THIS DOCUMENT AND ITS CONTENTS ARE THE PROPERTY OF MINI-CIRCUITS. EXCEPT FOR USE EXPRESSLY GRANTED, IN WRITING, TO ITS VENDORS, VENDEE AND THE UNITED STATES GOVERNMENT, MINI-CIRCUITS RESERVES ALL PROPRIETARY DESIGN, USE, MANUFACTURING AND REPRODUCTION RIGHTS THERETO. THESE CONTENTS SHALL NOT BE USED, DUPLICATED OR DISCLOSED TO ANY OUTSIDE PARTY, IN WHOLE OR IN PART, WITHOUT WRITTEN PERMISSION OF MINI-CIRCUITS.

| | | | |
|------------------|---------------------|--------------------------|------------|
| SIZE A | CODE IDENT 15542 | DRAWING NO: 98-PL-253 | REV: OR |
| FILE: 98PL253 | SCALE: 8:1 | SHEET: 1 OF 1 | |

Evaluation Board and Circuit

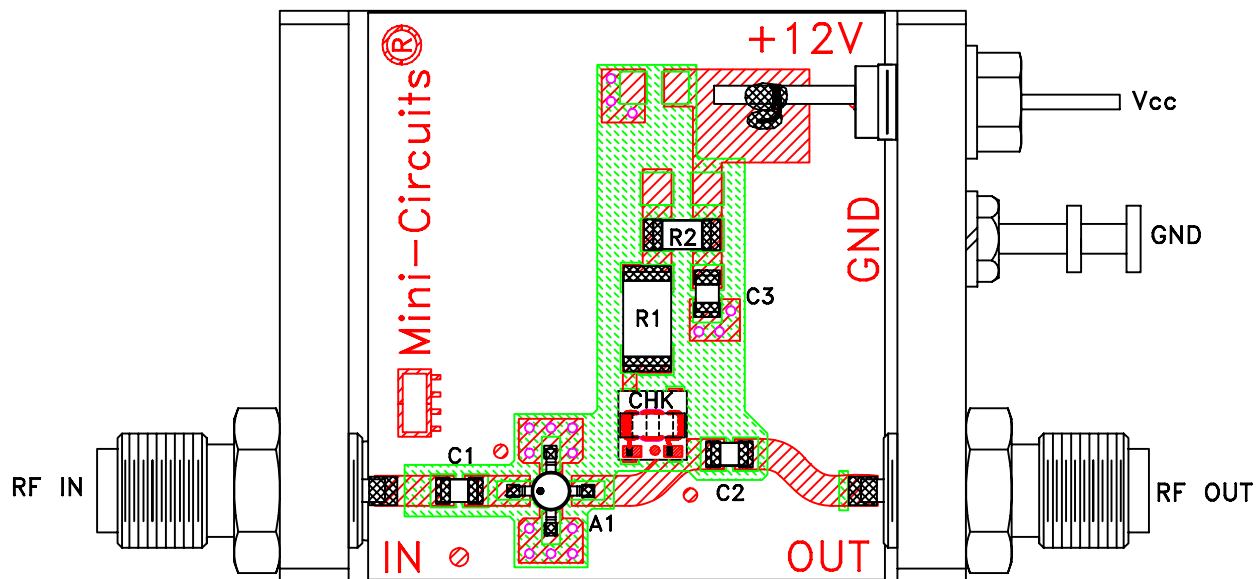

TB-411-8A+

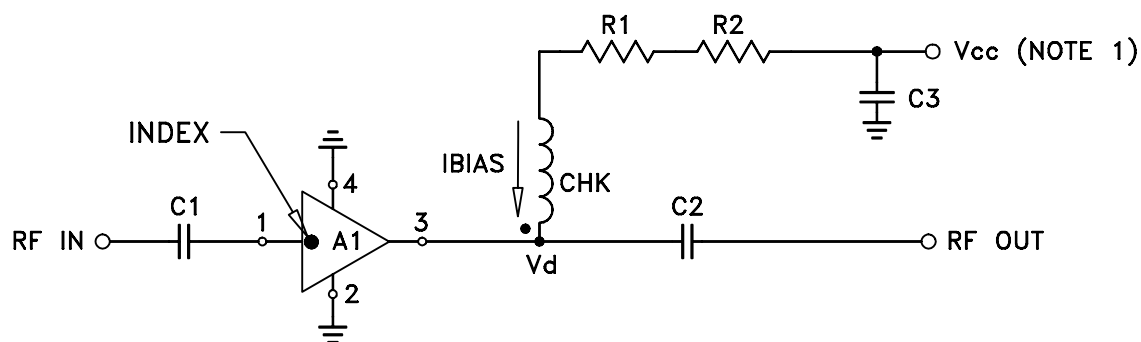

| COMPONENT | VALUE |
|-------------|------------------------|
| A1 | MAR-8ASM(+) |
| C1 (NOTE 4) | 2400 pF |
| C2 (NOTE 4) | 2400 pF |
| C3 (bypass) | 0.1 uF |
| R1 | 232 Ohms, 0.75W |
| R2 | 0 Ohm, 0.25W |
| CHK | Mini-Circuits TCCH-80+ |

Schematic Diagram

NOTE:

1. Vcc voltage: $+12 \pm 0.2V$.
2. SMA Female connectors.
3. PCB material: Rogers R04350 or equivalent, dielectric constant=3.5, dielectric thickness=.030 inch.
4. Capacitors, C1 & C2 should be free of resonance up to the highest frequency specified.

 Mini-Circuits®

All Mini-Circuits products are manufactured under exacting quality assurance and control standards, and are capable of meeting published specifications after being subjected to any or all of the following physical and environmental test.

| Specification | Test/Inspection Condition | Reference/Spec |
|--------------------------------|--|---|
| Operating Temperature | -40° to 85°C Ambient Environment | Individual Model Data Sheet |
| Storage Temperature | -55° to 100° C Ambient Environment | Individual Model Data Sheet |
| Thermal Shock | -55° to 100°C, 100 cycles | MIL-STD-202, Method 107, Condition A-3, except +100°C |
| Mechanical Shock | 1.5Kg, 0.5 ms, 5 shock pulses, Y1 direction only | MIL-STD-883, Method 2002, Condition B, except Y1 direction only |
| Vibration (Variable Frequency) | 50g peak | MIL-STD-883, Method 2007, Condition B |
| Autoclave | 15 psig, 100% RH, 121°C, 96 hours | JESD22-A102, Condition C |
| HAST | 130°C, 85% RH, 96 hours | JESD22-A110 |
| Solderability | 10X Magnification | J-STD-002, Para 4.2.5, Test S, 95% Coverage |
| Solder Reflow Heat | Sn-Pb Eutetic Process: 240°C peak Pb-Free Process: 260°C peak | J-STD-020, Table 4-1, 4-2 and 5-2; Figure 5-1 |
| Moisture Sensitivity: Level 1 | Bake at 125°C for 24 hours Soak at 85°C/85% RH for 168 hours, Reflow 3 cycles at 260°C peak | J-STD-020 |
| Marking Resistance to Solvents | Isopropyl alcohol + mineral spirits at 25°C; terpene defluxer at 25°C; distilled water + proylene glycol monomethyl ether + | MIL-STD-202, Method 215 |



All Mini-Circuits products are manufactured under exacting quality assurance and control standards, and are capable of meeting published specifications after being subjected to any or all of the following physical and environmental test.

| Specification | Test/Inspection Condition | Reference/Spec |
|---------------|---------------------------|----------------|
|---------------|---------------------------|----------------|

monoethanolamine at 63°C to 70°C