

1N4933, 1N4934, 1N4935, 1N4936, 1N4937

Axial-Lead Glass Passivated Fast Recovery Rectifiers

Axial-lead, fast-recovery rectifiers are designed for special applications such as DC power supplies, inverters, converters, ultrasonic systems, choppers, low RF interference and free wheeling diodes. A complete line of fast recovery rectifiers having typical recovery time of 150 nanoseconds providing high efficiency at frequencies to 250 kHz.

Features

- Shipped in Plastic Bags; 1,000 per Bag
- Available Tape and Reeled; 5,000 per Reel, by Adding a “RL” Suffix to the Part Number
- These are Pb-Free Devices*

Mechanical Characteristics:

- Case: Epoxy, Molded
- Weight: 0.4 Gram (Approximately)
- Finish: All External Surfaces Corrosion Resistant and Terminal Leads are Readily Solderable
- Lead Temperature for Soldering Purposes:
260°C Max. for 10 Seconds
- Polarity: Cathode Indicated by Polarity Band

*For additional information on our Pb-Free strategy and soldering details, please download the ON Semiconductor Soldering and Mounting Techniques Reference Manual, SOLDERRM/D.



ON Semiconductor®

www.onsemi.com

FAST RECOVERY RECTIFIERS 1.0 AMPERE, 50–600 VOLTS

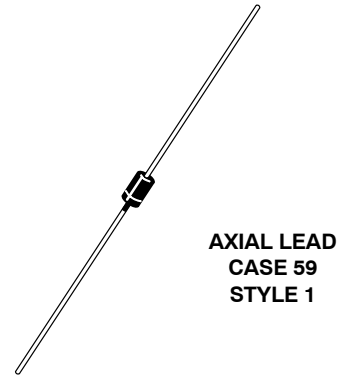

MARKING DIAGRAM

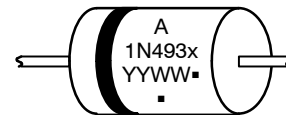

A = Assembly Location
1N493x = Device Number
x = 3, 4, 5, 6 or 7
YY = Year
WW = Work Week
▪ = Pb-Free Package

(Note: Microdot may be in either location)

ORDERING INFORMATION

See detailed ordering and shipping information on page 3 of this data sheet.

1N4933, 1N4934, 1N4935, 1N4936, 1N4937

MAXIMUM RATINGS (Note 1)

Rating	Symbol	1N4933	1N4934	1N4935	1N4936	1N4937	Unit
†Peak Repetitive Reverse Voltage Working Peak Reverse Voltage DC Blocking Voltage	V_{RRM} V_{RWM} V_R	50	100	200	400	600	V
†Non-Repetitive Peak Reverse Voltage RMS Reverse Voltage	V_{RSM} $V_{R(RMS)}$	75 35	150 70	250 140	450 280	650 420	V
†Average Rectified Forward Current (Single phase, resistive load, $T_A = 75^\circ\text{C}$) (Note 2)	I_O	1.0					A
†Non-Repetitive Peak Surge Current (Surge applied at rated load conditions)	I_{FSM}	30					A
Operating Junction Temperature Range Storage Temperature Range	T_J, T_{stg}	- 65 to +150					$^\circ\text{C}$

Stresses exceeding those listed in the Maximum Ratings table may damage the device. If any of these limits are exceeded, device functionality should not be assumed, damage may occur and reliability may be affected.

1. Ratings at 25°C ambient temperature unless otherwise specified.
2. Derate by 20% for capacitive loads.

THERMAL CHARACTERISTICS

Characteristic	Symbol	Max	Unit
Thermal Resistance, Junction-to-Ambient (Typical Printed Circuit Board Mounting)	$R_{\theta JA}$	65	$^\circ\text{C/W}$

ELECTRICAL CHARACTERISTICS

Characteristic	Symbol	Min	Typ	Max	Unit
Instantaneous Forward Voltage ($I_F = 3.14$ Amp, $T_J = 150^\circ\text{C}$)	V_F	-	1.0	1.2	V
Forward Voltage ($I_F = 1.0$ Amp, $T_A = 25^\circ\text{C}$)	V_F	-	1.05	1.2	V
†Reverse Current (Rated DC Voltage) $T_A = 25^\circ\text{C}$ $T_A = 100^\circ\text{C}$	I_R	-	1.0 50	5.0 100	μA

REVERSE RECOVERY CHARACTERISTICS†

Reverse Recovery Time ($I_F = 1.0$ Amp to $V_R = 30$ Vdc) ($I_{FM} = 15$ Amp, $di/dt = 10$ A/ μs)	t_{rr}	-	150 175	200 300	ns
Reverse Recovery Current ($I_F = 1.0$ Amp to $V_R = 30$ Vdc)	$I_{RM(REC)}$	-	1.0	2.0	A

Product parametric performance is indicated in the Electrical Characteristics for the listed test conditions, unless otherwise noted. Product performance may not be indicated by the Electrical Characteristics if operated under different conditions.

†Indicates JEDEC Registered Data for 1N4933 Series.

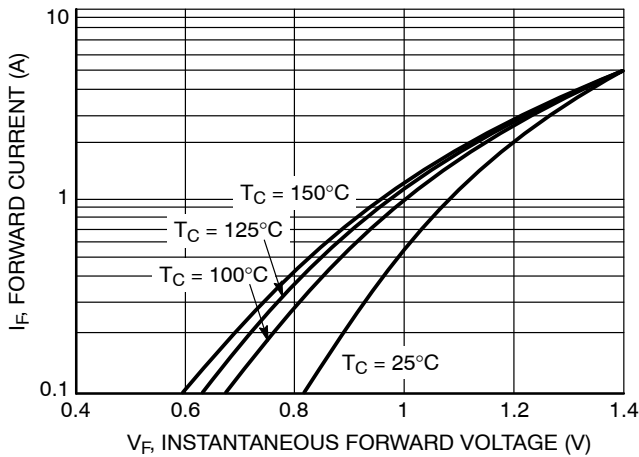

Figure 1. Typical Forward Voltage

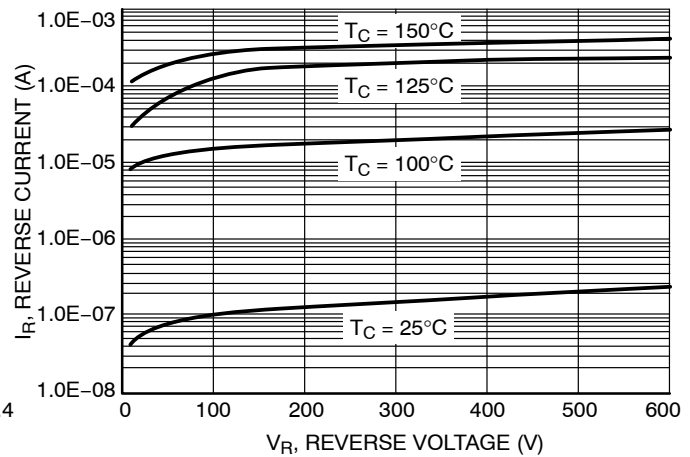

Figure 2. Typical Reverse Current

1N4933, 1N4934, 1N4935, 1N4936, 1N4937

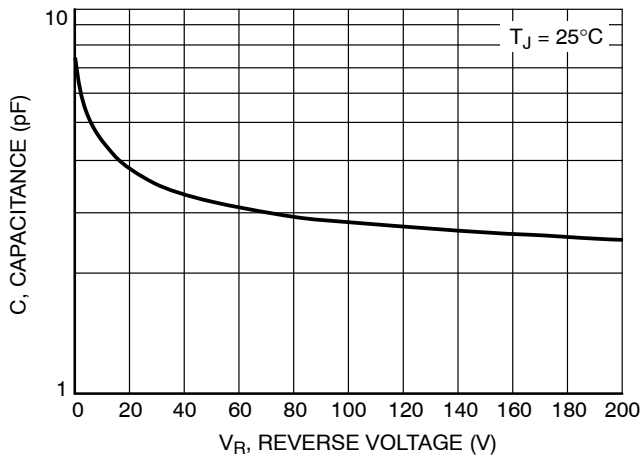

Figure 3. Typical Capacitance

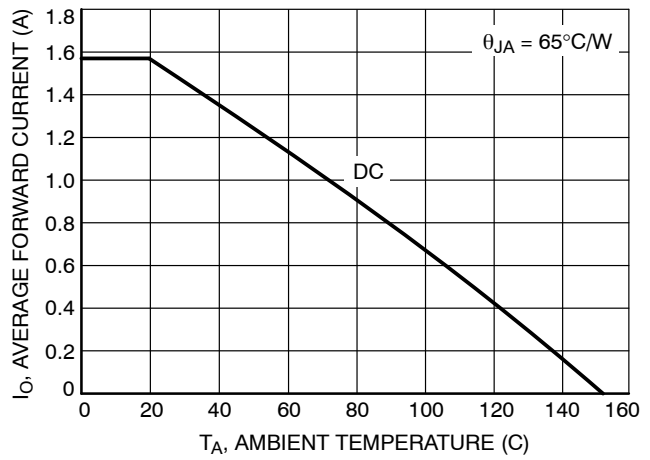

Figure 4. Current Derating

ORDERING INFORMATION

Device	Package	Shipping†
1N4933	Axial Lead*	1000 Units / Bag
1N4933G	Axial Lead*	1000 Units / Bag
1N4933RL	Axial Lead*	5000 / Tape & Reel
1N4933RLG	Axial Lead*	5000 / Tape & Reel
1N4934	Axial Lead*	1000 Units / Bag
1N4934G	Axial Lead*	1000 Units / Bag
1N4934RL	Axial Lead*	5000 / Tape & Reel
1N4934RLG	Axial Lead*	5000 / Tape & Reel
1N4935	Axial Lead*	1000 Units / Bag
1N4935G	Axial Lead*	1000 Units / Bag
1N4935RL	Axial Lead*	5000 / Tape & Reel
1N4935RLG	Axial Lead*	5000 / Tape & Reel
1N4936	Axial Lead*	1000 Units / Bag
1N4936G	Axial Lead*	1000 Units / Bag
1N4936RL	Axial Lead*	5000 / Tape & Reel
1N4936RLG	Axial Lead*	5000 / Tape & Reel
1N4937	Axial Lead*	1000 Units / Bag
1N4937G	Axial Lead*	1000 Units / Bag
1N4937RL	Axial Lead*	5000 / Tape & Reel
1N4937RLG	Axial Lead*	5000 / Tape & Reel

†For information on tape and reel specifications, including part orientation and tape sizes, please refer to our Tape and Reel Packaging Specifications Brochure, BRD8011/D.

*This package is inherently Pb-Free.

MECHANICAL CASE OUTLINE

PACKAGE DIMENSIONS

ON Semiconductor®



AXIAL LEAD CASE 59-10 ISSUE U

DATE 15 FEB 2005

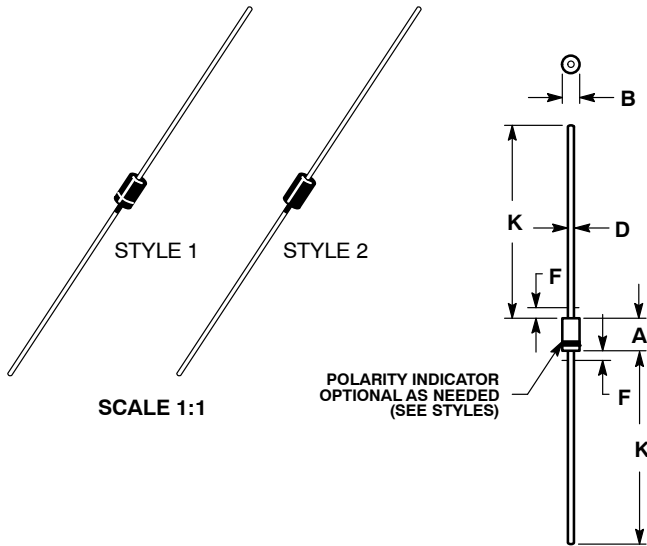

SCALE 1:1

POLARITY INDICATOR
OPTIONAL AS NEEDED
(SEE STYLES)

STYLE 1:
PIN 1. CATHODE (POLARITY BAND)
2. ANODE

STYLE 2:
NO POLARITY

NOTES:

1. DIMENSIONING AND TOLERANCING PER ANSI Y14.5M, 1982.
2. CONTROLLING DIMENSION: INCH.
3. ALL RULES AND NOTES ASSOCIATED WITH JEDEC DO-41 OUTLINE SHALL APPLY
4. POLARITY DENOTED BY CATHODE BAND.
5. LEAD DIAMETER NOT CONTROLLED WITHIN F DIMENSION.

DIM	INCHES		MILLIMETERS	
	MIN	MAX	MIN	MAX
A	0.161	0.205	4.10	5.20
B	0.079	0.106	2.00	2.70
D	0.028	0.034	0.71	0.86
F	---	0.050	---	1.27
K	1.000	---	25.40	---

GENERIC MARKING DIAGRAM*

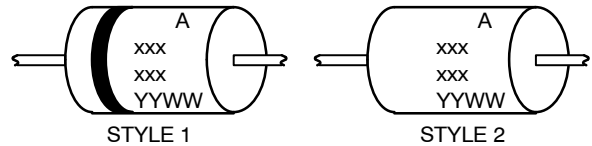

- xxx = Specific Device Code
- A = Assembly Location
- YY = Year
- WW = Work Week

*This information is generic. Please refer to device data sheet for actual part marking. Pb-Free indicator, "G" or microdot "▪", may or may not be present.

DOCUMENT NUMBER:	98ASB42045B	Electronic versions are uncontrolled except when accessed directly from the Document Repository. Printed versions are uncontrolled except when stamped "CONTROLLED COPY" in red.
DESCRIPTION:	AXIAL LEAD	PAGE 1 OF 1

ON Semiconductor and are trademarks of Semiconductor Components Industries, LLC dba ON Semiconductor or its subsidiaries in the United States and/or other countries. ON Semiconductor reserves the right to make changes without further notice to any products herein. ON Semiconductor makes no warranty, representation or guarantee regarding the suitability of its products for any particular purpose, nor does ON Semiconductor assume any liability arising out of the application or use of any product or circuit, and specifically disclaims any and all liability, including without limitation special, consequential or incidental damages. ON Semiconductor does not convey any license under its patent rights nor the rights of others.

ON Semiconductor and  are trademarks of Semiconductor Components Industries, LLC dba ON Semiconductor or its subsidiaries in the United States and/or other countries. ON Semiconductor owns the rights to a number of patents, trademarks, copyrights, trade secrets, and other intellectual property. A listing of ON Semiconductor's product/patent coverage may be accessed at www.onsemi.com/site/pdf/Patent-Marking.pdf. ON Semiconductor reserves the right to make changes without further notice to any products herein. ON Semiconductor makes no warranty, representation or guarantee regarding the suitability of its products for any particular purpose, nor does ON Semiconductor assume any liability arising out of the application or use of any product or circuit, and specifically disclaims any and all liability, including without limitation special, consequential or incidental damages. Buyer is responsible for its products and applications using ON Semiconductor products, including compliance with all laws, regulations and safety requirements or standards, regardless of any support or applications information provided by ON Semiconductor. "Typical" parameters which may be provided in ON Semiconductor data sheets and/or specifications can and do vary in different applications and actual performance may vary over time. All operating parameters, including "Typicals" must be validated for each customer application by customer's technical experts. ON Semiconductor does not convey any license under its patent rights nor the rights of others. ON Semiconductor products are not designed, intended, or authorized for use as a critical component in life support systems or any FDA Class 3 medical devices or medical devices with a same or similar classification in a foreign jurisdiction or any devices intended for implantation in the human body. Should Buyer purchase or use ON Semiconductor products for any such unintended or unauthorized application, Buyer shall indemnify and hold ON Semiconductor and its officers, employees, subsidiaries, affiliates, and distributors harmless against all claims, costs, damages, and expenses, and reasonable attorney fees arising out of, directly or indirectly, any claim of personal injury or death associated with such unintended or unauthorized use, even if such claim alleges that ON Semiconductor was negligent regarding the design or manufacture of the part. ON Semiconductor is an Equal Opportunity/Affirmative Action Employer. This literature is subject to all applicable copyright laws and is not for resale in any manner.

PUBLICATION ORDERING INFORMATION

LITERATURE FULFILLMENT:

Email Requests to: orderlit@onsemi.com

ON Semiconductor Website: www.onsemi.com

TECHNICAL SUPPORT

North American Technical Support:
Voice Mail: 1 800-282-9855 Toll Free USA/Canada
Phone: 011 421 33 790 2910

Europe, Middle East and Africa Technical Support:

Phone: 00421 33 790 2910

For additional information, please contact your local Sales Representative

Mouser Electronics

Authorized Distributor

Click to View Pricing, Inventory, Delivery & Lifecycle Information:

ON Semiconductor:

[1N4935](#) [1N4936](#) [1N4933](#) [1N4933G](#) [1N4933RL](#) [1N4933RLG](#) [1N4934](#) [1N4934G](#) [1N4934RL](#) [1N4934RLG](#)
[1N4935G](#) [1N4935RL](#) [1N4935RLG](#) [1N4936G](#) [1N4936RL](#) [1N4936RLG](#) [1N4937](#) [1N4937G](#) [1N4937RL](#) [1N4937RLG](#)